

**Modular Crimp Head
Order No. 63825-9670**

Application Tooling Specification Sheet

**Hand Crimp Tool
Order No. 63825-9600**

FEATURES

- % A full cycle ratcheting hand tool ensures complete crimps
- % Ergonomically designed soft handles
- % Precisely designed crimping profiles with simple contact positioning
- % Easy handling due to outstanding force ratio
- % Modular Crimp Head is removable and can be use in the Air Powered Tool Order No.63816-0100, accompanied by Air Powered Crimp Adapter (Order No. 63816-0700).
- % Can also be used in the Battery Powered Tool Order No.63816-0200 (110 V) or 63816-0250 (220 V) accompanied by Battery Powered Crimp Adapter (Order No. 63816-0600).

SCOPE

Products: 4.0mm Pitch Motor Crimp Terminal, 22 AWG.

Terminal Series No.	Terminal Order No.		Wire Size and Type (1)			Insulation Diameter				Strip Length	
						IPC/WHMA-A620m (2)		Terminal (3) Maximum			
	Reel(4)	Loose	AWG	mm ²	Type	mm	In.	mm	In.	mm	In.
59333	59333-8100	59333-8000	22	0.32-0.34	UL1007	1.15-1.50	.045-.059	1.75	.069	1.60-2.10	.063-.083
			22	0.32-0.34	UL1061	1.30-1.50	.051-.059	1.75	.069	1.60-2.10	.063-.083

(1). This hand tool will crimp other wire types of equivalent gauge size. (The hand tool frame is labeled for convenience.)
 (2) To achieve optimum IPC-A620 insulation crimps, use this insulation OD range.
 (3) Overall insulation OD specification for terminal.
 (4) Customer to cut off terminal from reel: 0.15m (.006") maximum Cut-off Tab.

DEFINITION OF TERMS

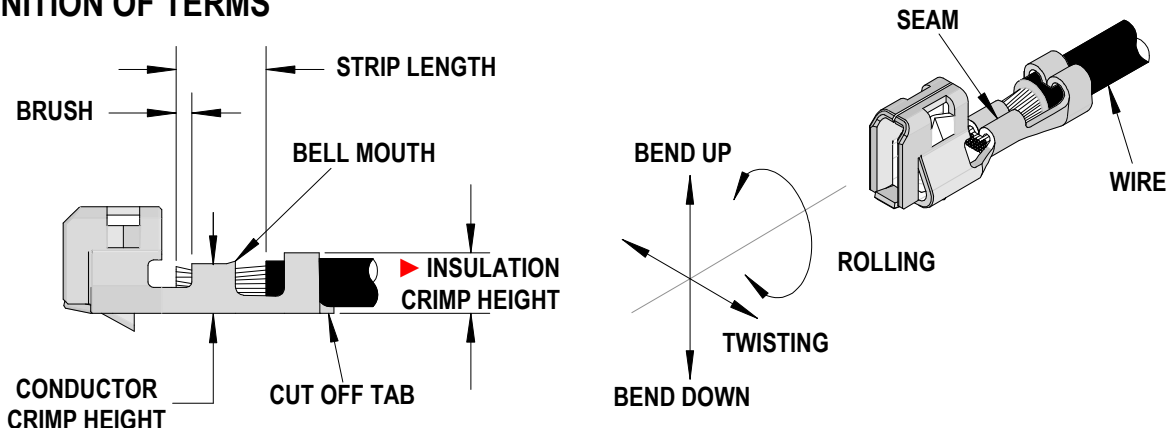

This illustration is a generic terminal representation and not an exact image of any terminal listed in the scope.

▲ Insulation Crimp Note:

Due to the terminal’s insulation grip design and/or insulation diameter range, this tool uses “overlap” form geometry in the insulation punch. This produces an overlap insulation crimp (A620 – compliant). While the insulation punch profile may appear “lopsided”, this is a normal condition for this tool. See figure to the right. (Some tools with multiple crimp pockets may not have the “overlap” profile on all pockets).

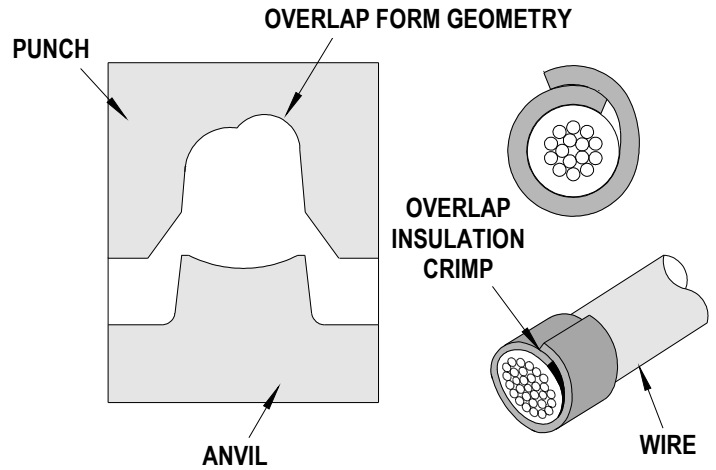

CONDITIONS:

After crimping, the crimp profiles should measure the following.

Terminal Series No	Wire Size and Type			Conductor Crimp (Ref.)				Profile	
				Height		Width (Ref)			
	AWG	mm ²	Type	mm	In.	mm	In.	22 UL1007	22 UL 1061
59333	22	0.32-0.34	UL1007	0.70-0.75	.028-.030	1.10	.043	X	
	22	0.32-0.34	UL1061	0.70-0.75	.028-.030	1.10	.043		X

Terminal Series No	Wire Size and Type			Insulation Crimp (Ref.)				Pull Force Minimum	
				Height		Width (Ref)			
	AWG	mm ²	Type	mm	In.	mm	In.	N	Lb.
59333	22	0.32-0.34	UL1007	1.55-1.75	.061-.069	1.50	.060	39.2	8.8
	22	0.32-0.34	UL1061	1.55-1.75	.061-.069	1.50	.060	39.2	8.8

Tool Qualification Notes:

1. Pull Force should be measured with no influence from the insulation crimp.
2. The above specifications are guidelines to an optimum crimp.

OPERATION

Open the tool by squeezing the handles together, at the end of the closing stroke, the ratchet mechanism will release the handles, and the hand tool will spring open.

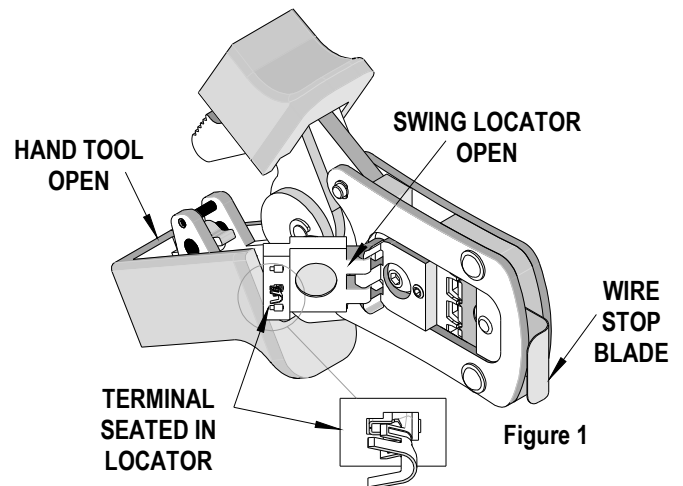

1. With the hand tool in the open position, pivot the terminal locator open by pulling up on the locator knob and lift the wire stop blade up. See Figure 1.
2. Insert the terminal into the correct profile until the terminal is fully seated and stops. Make sure the wire stop blade is fully seated on the terminal behind the conductor grip section.
3. Gently pivot the locator closed.
4. Bring down the wire stop blade.
5. Slide the pre-stripped wire into the terminal; make sure to aim the wire brush towards the tip point on the wire stop blade. See Figure 2. Align the wire so that it is parallel and sitting into the terminal. Maintain a light and constant pressure on the wire that is seated in the terminal at all times. (Do not let go of the wire.) Be sure to hold the wire and terminal in place until the terminal is fully crimped. See Figure 3.

- Close the tool until the ratchet releases.

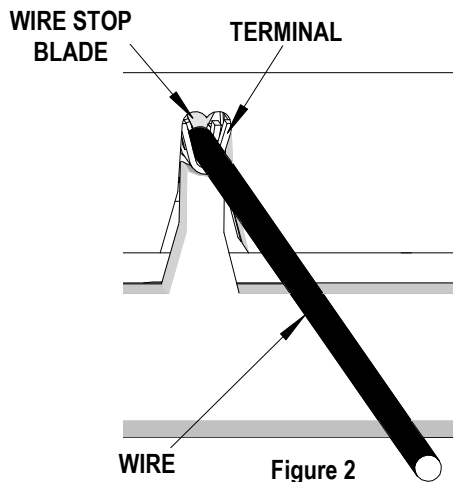

Figure 2

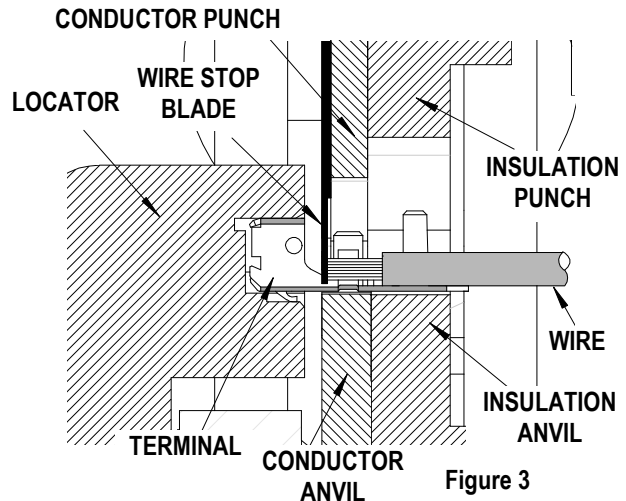

Figure 3

Note: The tamper proof ratchet action will not release the tool until it has been fully closed.

- Lift the wire stop blade up.
- Carefully remove the crimped terminal.

Note: To maintain good brush control and a consistent bell mouth the crimping instructions must be followed.

Terminal Locator Replacement

Removal

- With the tool in the open position, pivot the terminal locator outward.
- Remove the M4 BHCS. See Figure 4.

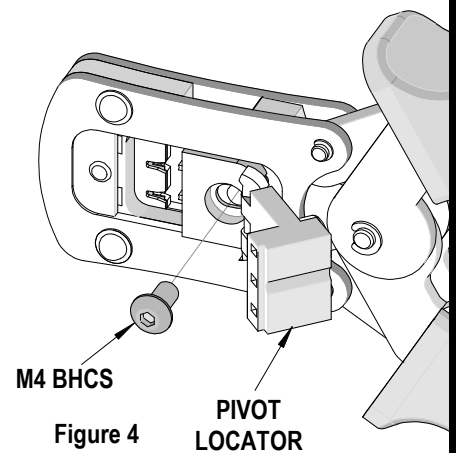

Figure 4

Installation

- Place the new locator, (See Chart on page 2), on the hand tool. Install the M4 BHCS. See Figure 4.
- Tighten the screw enough to hold the locator. Make sure the locator can still float freely with hand pressure.
- Insert the proper terminal fully into the correct profile slot until the terminal is fully seated and stops. Then gently pivot the locator closed.
- With hand pressure, slowly slide the locator to the correct position. See Figure 5.
- Gently pivot the locator open without disturbing the location.
- Hold the locator firmly in place and slowly tighten the M4 BHCS.

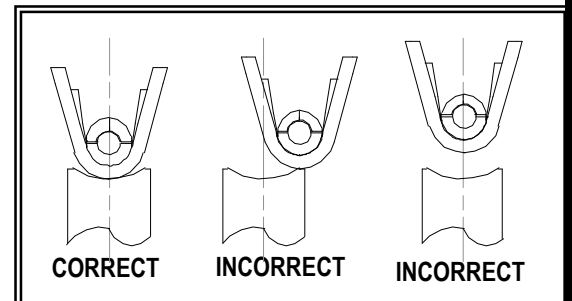

Figure 5

Maintenance

It is recommended that each operator of the tool be made aware of, and responsible for, the following maintenance steps:

- Remove dust, moisture, and other contaminants with a clean brush, or soft, lint free cloth.
- Do not use any abrasive materials that could damage the tool.

3. Make certain all pins; pivot points and bearing surfaces are protected with a thin coat of high quality machine oil. Do not oil excessively. The tool was engineered for durability but like any other equipment it needs cleaning and lubrication for a maximum service life of trouble free crimping. Light oil (such as 30 weight automotive oil) used at the oil points, every 5,000 crimps or 3 months, will significantly enhance the tool life.
4. Wipe excess oil from hand tool, particularly from crimping area. Oil transferred from the crimping area onto certain terminations may affect the electrical characteristics of an application.
5. When tool is not in use, keep the handles closed to prevent objects from becoming lodged in the crimping dies, and store the tool in a clean, dry area.

Miscrimps or Jams

Should this tool ever become stuck or jammed in a partially closed position, **Do Not force the handles open or closed**. The tool will open easily by lifting the ratchet release lever. See Figure 6.

Warranty

This tool is for electrical terminal crimping purposes only. This tool is made of the best quality materials. All vital components are long life tested. All tools are warranted to be free of manufacturing defects for a period of 30 days. Should such a defect occur, we will repair or exchange the tool free of charge. This repair or exchange will not be applicable to altered, misused, or damaged tools. This tool is designed for hand use only. Any clamping, fixturing, or use of handle extensions voids this warranty.

CAUTION: Repetitive use of this tool should be avoided.

CAUTIONS:

1. Manually powered hand tools are intended for low volume or field repair. This tool is **NOT** intended for production use. Repetitive use of this tool should be avoided.
2. Insulated rubber handles are not protection against electrical shock.
3. Wear eye protection at all times.
4. Use only the Molex terminals specified for crimping with this tool.

Notes:

1. This tool should only be used for the terminals and wire gauges specified on this sheet.
2. This tool is not adjustable for crimp height; however crimp force is adjustable (See instructions above). Variations in tools, terminals, wire stranding and insulation types may affect crimp height.
3. This tool is intended for standard conductor sizes. It may not give a good insulation crimp support for all insulation sizes.
4. Molex does not repair hand tools (see warranty above). The replacement parts listed are the only parts available for repair. If the handles or crimp tooling is damaged or worn, a new tool must be purchased.
5. Pull force should be used as the final criteria for an acceptable crimp. Pull force is measured with no influence from the insulation crimp. The insulation should be stripped long (1/2 in.) so the insulation grips on the terminal do not grip the wire insulation or the conductor. Refer to Molex Quality Crimping Handbook 63800-0029 for additional information on crimping and crimp testing.
6. Molex does not certify crimp hand tools.

CAUTION: Molex crimp specifications are valid only when used with Molex terminals and tooling.

Applications for the Modular Crimp Head

WARNING: NEVER operate, service, install, or adjust this Modular Crimp Head without proper instruction and without first reading and understanding the instructions in the proper Manual or Specification Sheet. See Chart below for the correct Manual or Specification Sheet.

WARNING: NEVER install tooling or service this tool while it is into any power source. Disconnect the power by unplugging or turn off the Actuator from its power source.

CAUTION: Keep fingers away from the crimping area when operating this tool. It may cause severe injury.

CAUTION: Wear safety glasses when operating or serving this tool.

The chart below shows all applications for this Modular Crimp Head.

Modular Crimp Head Order No.	Tool Order no.	Tool Description	Adapter Order No.	Adapter Description	Figure No.
63825-9670	63816-0000	Hand Crimp Frame (Short)	N/A	N/A	3
	63816-0050	Hand Crimp Frame (Long)	N/A	N/A	3
	63816-0200	Battery Power Tool (110 V)	63816-0600	Battery Power Crimp Adapter	4
	63816-0250	Battery Power Tool (220 V)	63816-0600	Battery Power Crimp Adapter	4
	63816-0100	Air Power Tool	63816-0700	Air Power Crimp Adapter	5

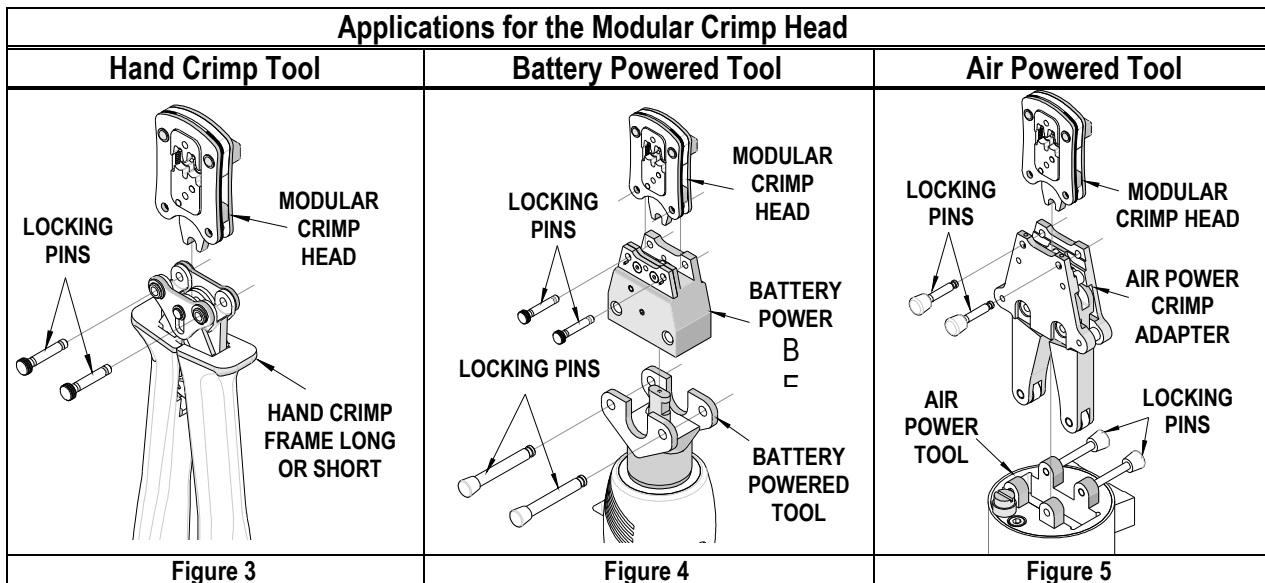

PARTS LIST

Hand Crimp Tool 63825-9600			
Item	Order Number	Description	Quantity
1	63825-9670	Modular Crimp Head	1 (Ref)
2	63816-0000	Hand Crimp Frame (short)	1 (Ref)
3	63825-9675	Locator	1
4	63816-0001	Locking Pin	2
5	63600-0525	Handle Spring	1
6	63600-0520	Crimping Spring	2

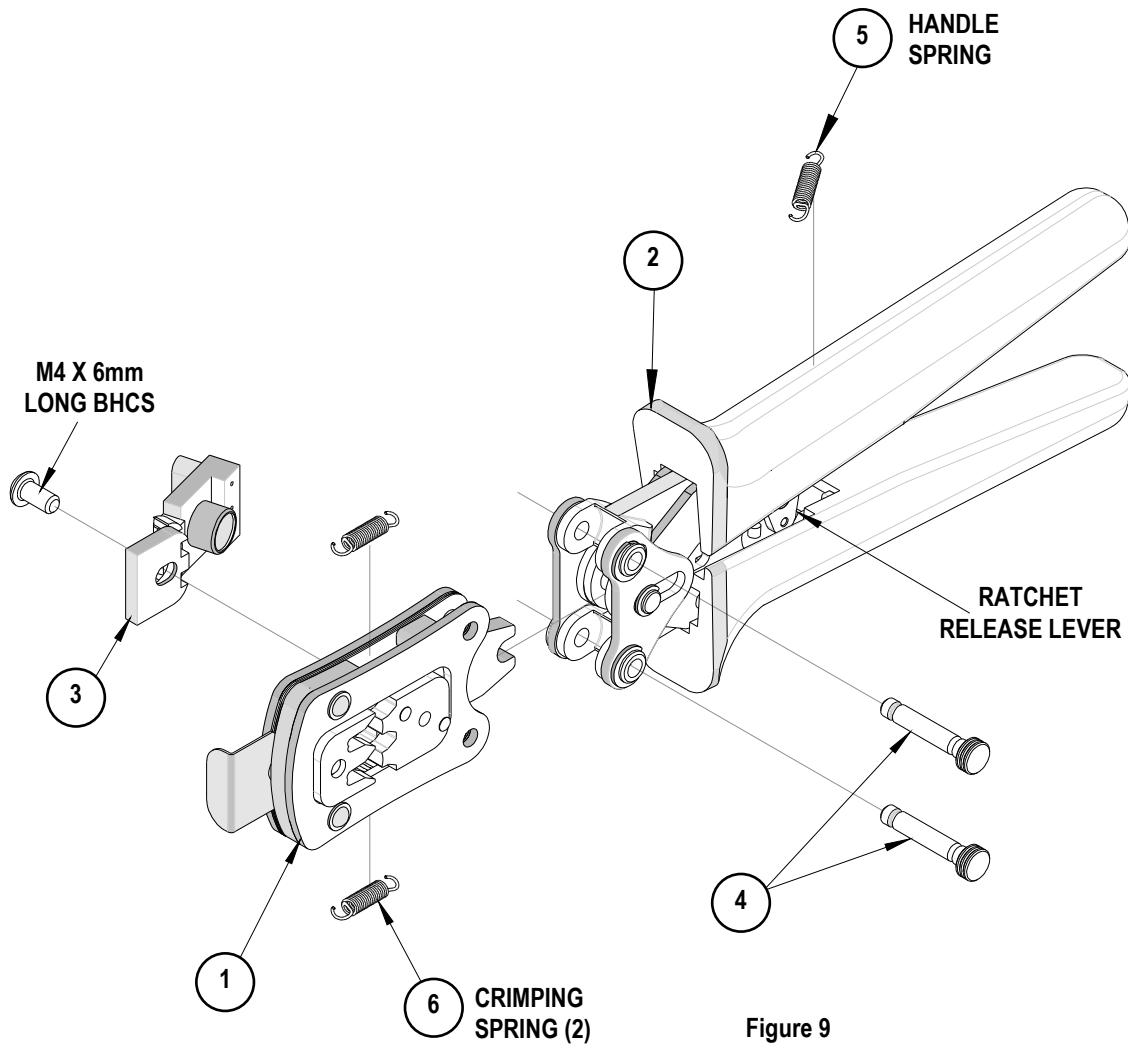

Visit our Web site at <http://www.molex.com>