

4G/LTE Flexible PCB Internal Antennas

Product Number : ATIFLTE-5717-80

1. Picture

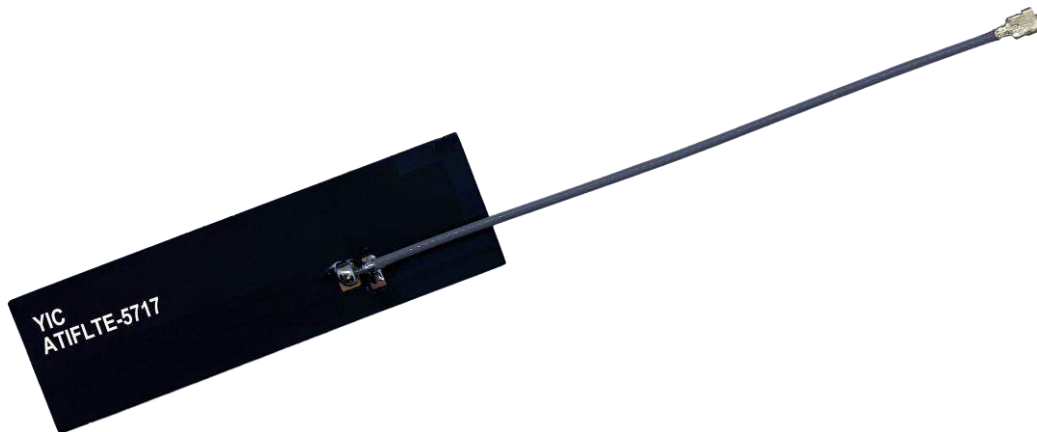

2. Electrical Characteristics

Item		Specifications
Antenna	Frequency Range	650 ~800 / 810 ~ 980 /1700 ~ 2690 MHz
	Polarization	Linear
	Gain	2dB
	V.S.W.R	<2.5
	Impedance	50 Ω
	Dimension	56.59 * 16.53 mm
Mechanical	Cable	RF1.13 or others
	Connector	IPEX
	Mounting Method	Embedded
Environmental	Operating Temperature	-40°C ~+85°C
	Vibration	10 to 55Hz with 1.5mm amplitude 2hours
	Environmentally Friendly	ROHS Compliant

3. Testing of Gain, Efficiency & Radiation Pattern

3.1 1720.00MHz – 2710.00MHz

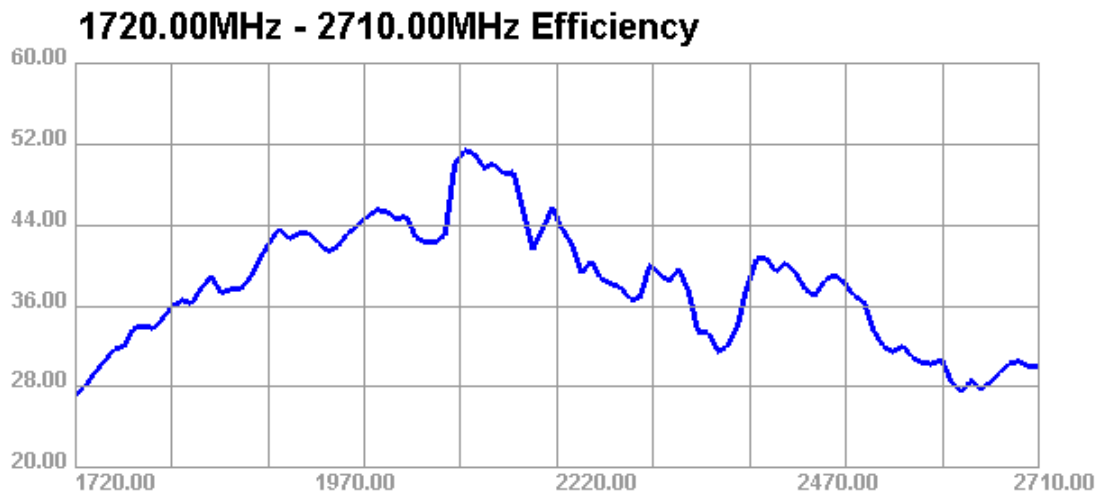
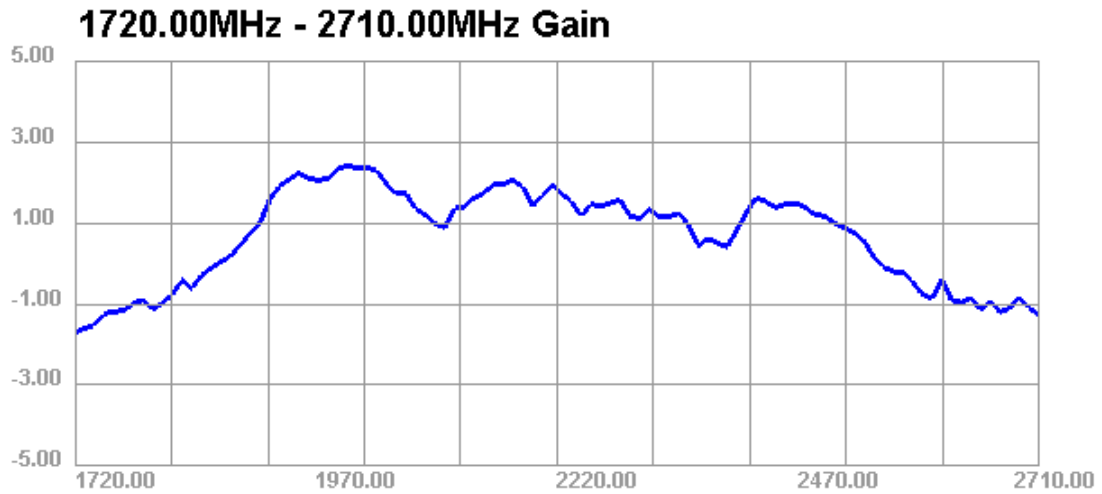

1720.000MHz

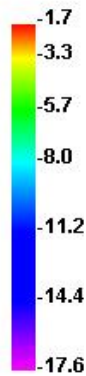
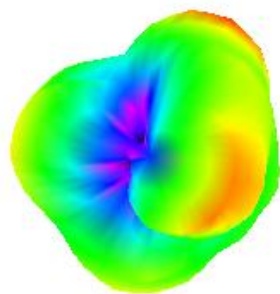

1720.000MHz H

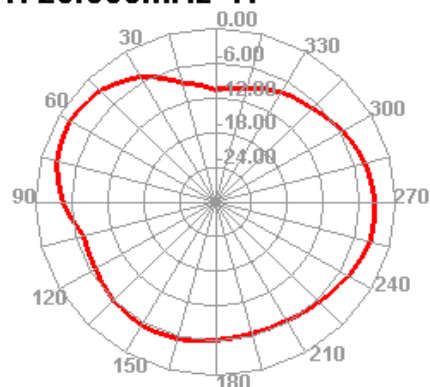

1720.000MHz E1

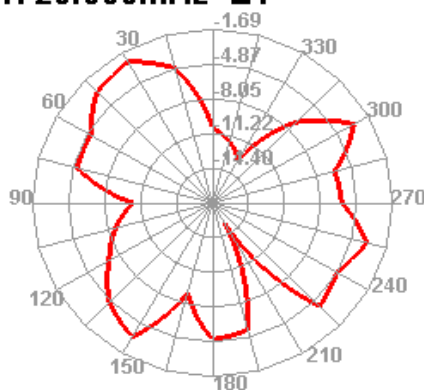

1720.000MHz E2

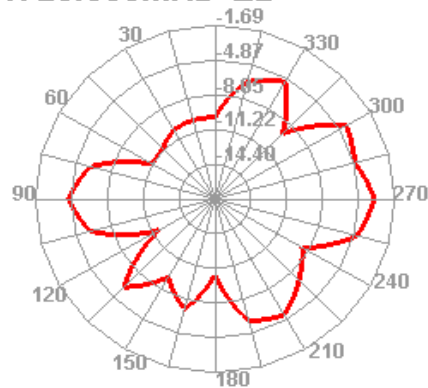

1730.000MHz

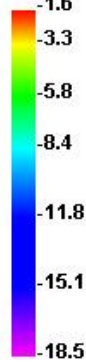
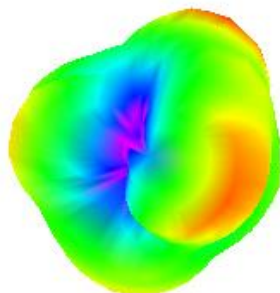

1730.000MHz H

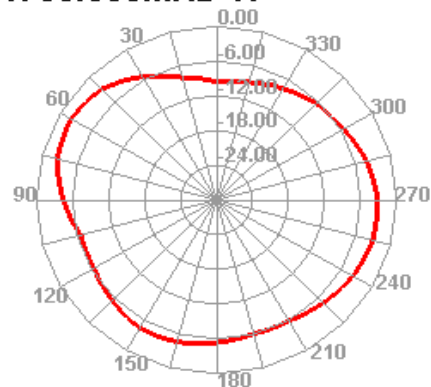

1730.000MHz E1

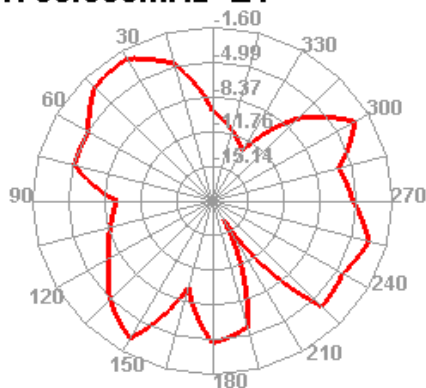

1730.000MHz E2

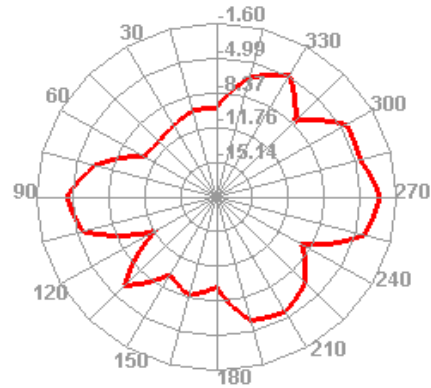

1740.000MHz

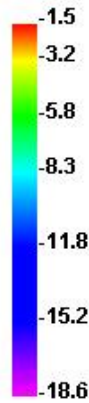
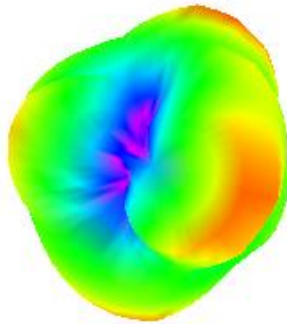

1740.000MHz H

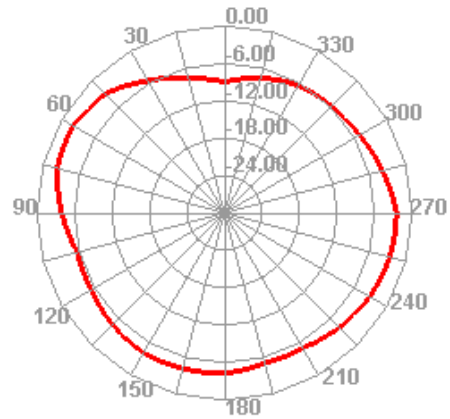

1740.000MHz E1

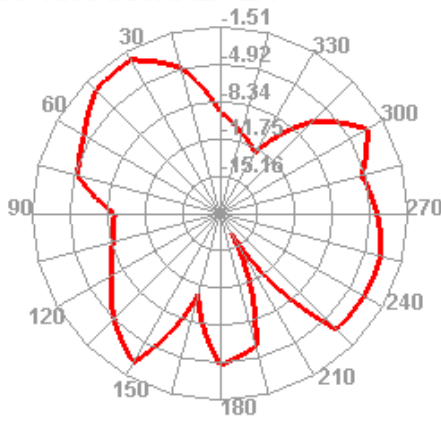

1740.000MHz E2

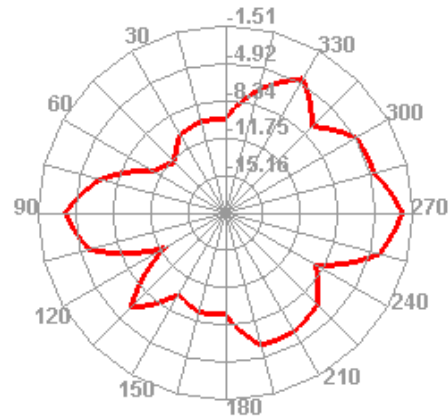

3.2 810.00MHz – 980.00MHz

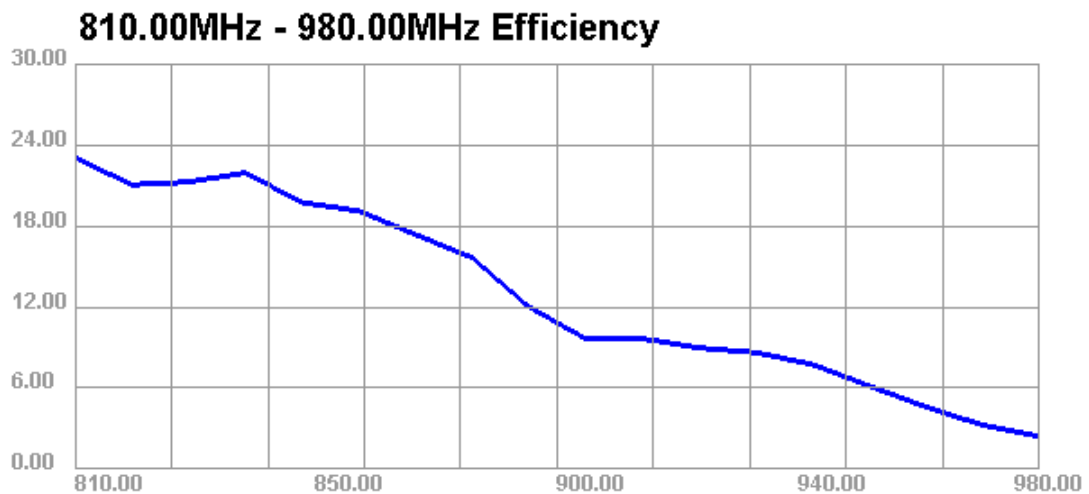
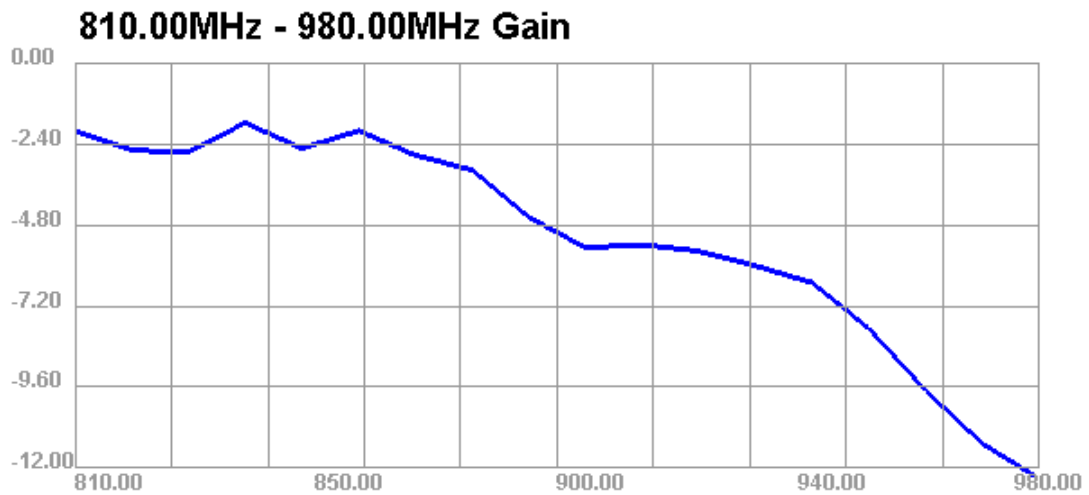

810.000MHz

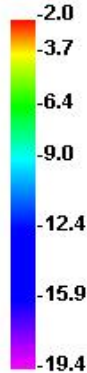
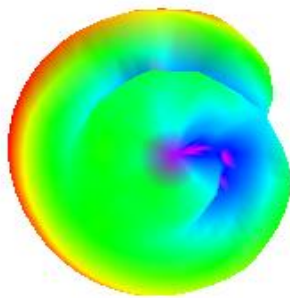

810.000MHz H

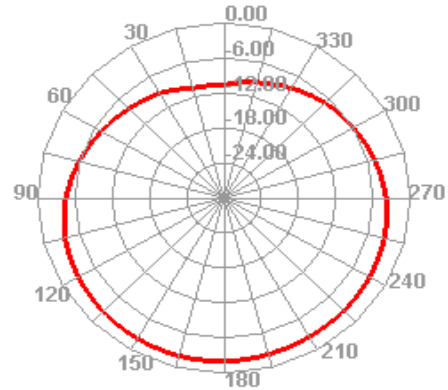

810.000MHz E1

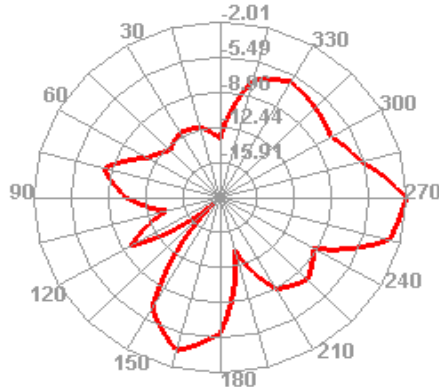

810.000MHz E2

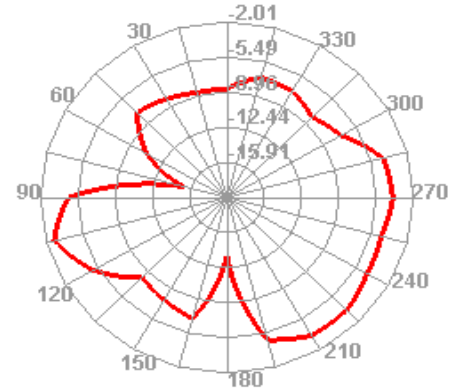

820.000MHz

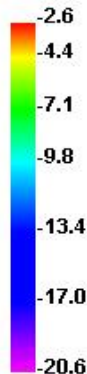
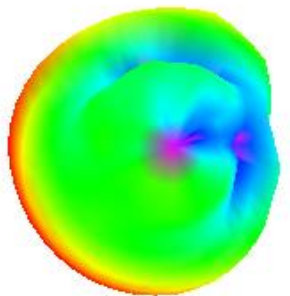

820.000MHz H

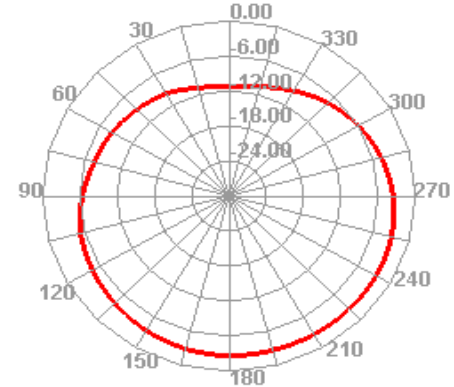

820.000MHz E1

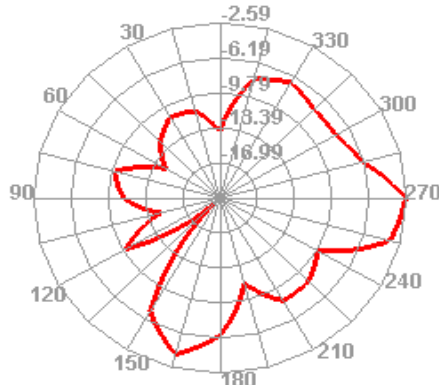

820.000MHz E2

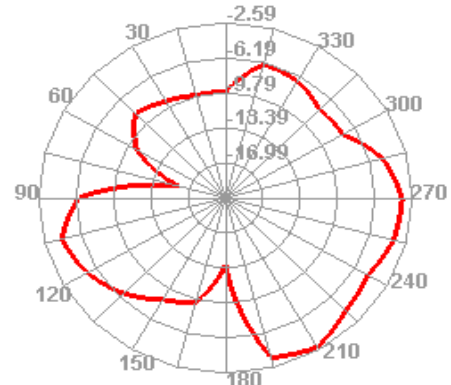

830.000MHz

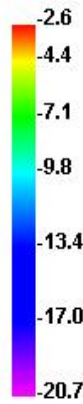
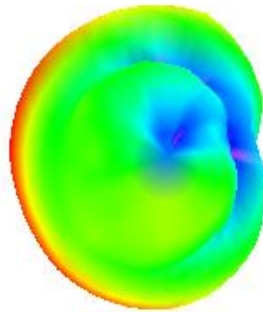

830.000MHz H

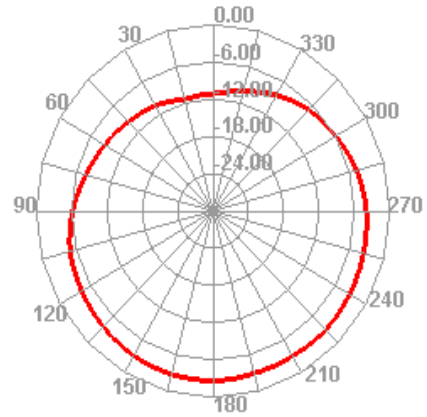

830.000MHz E1

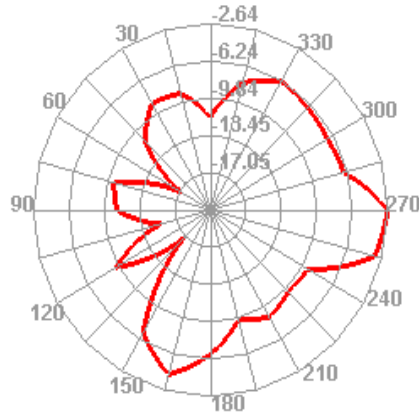

830.000MHz E2

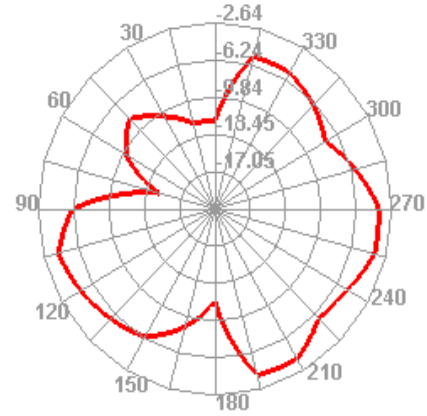

3.3 650.00MHz – 800.00MHz

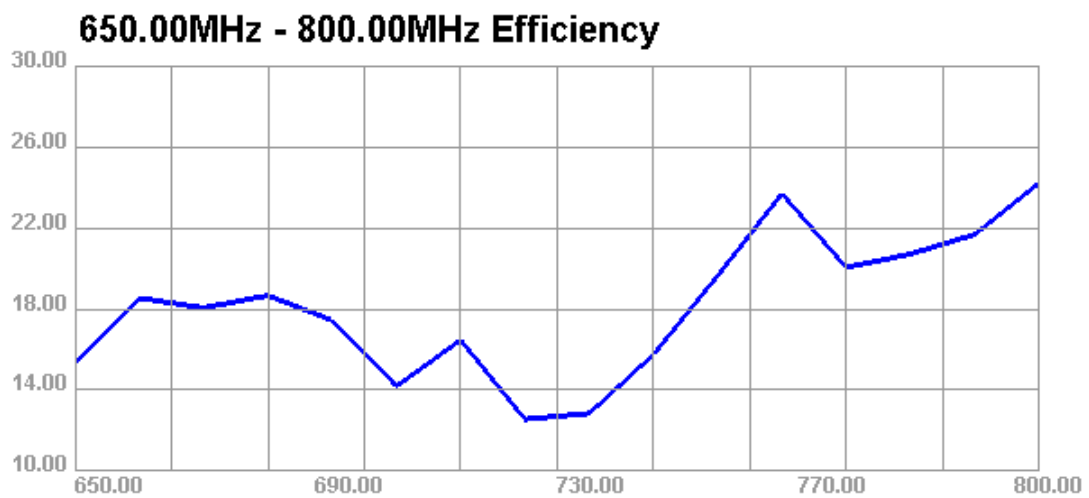
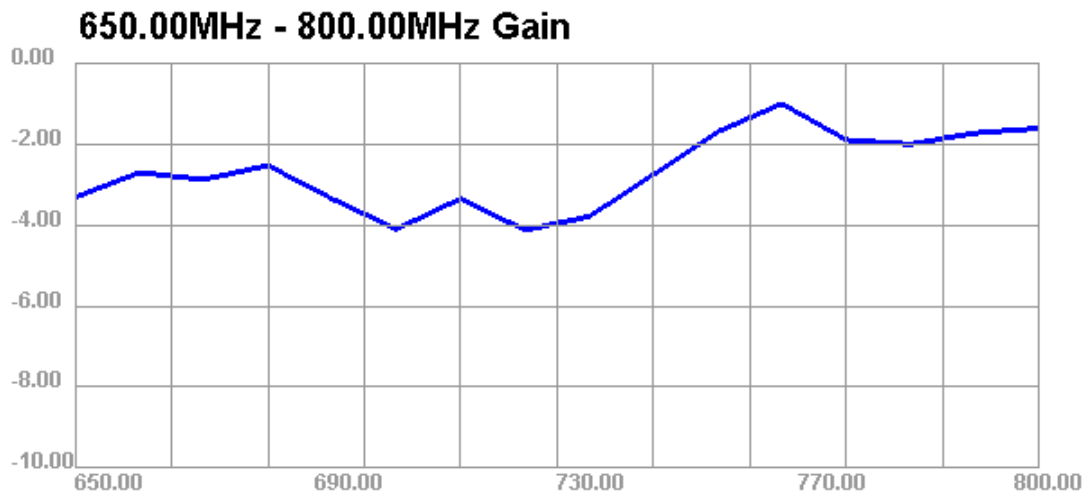

650.000MHz

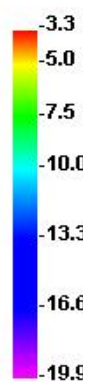
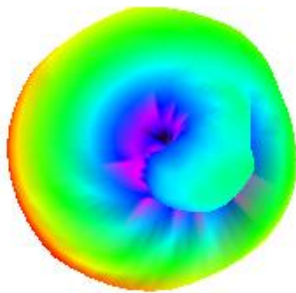

650.000MHz H

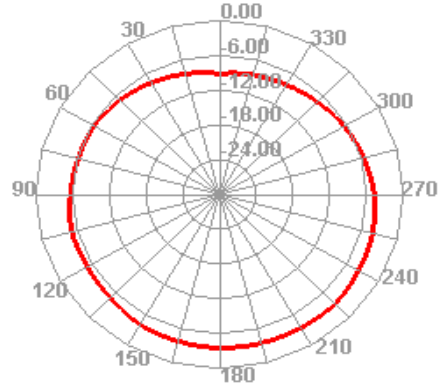

650.000MHz E1

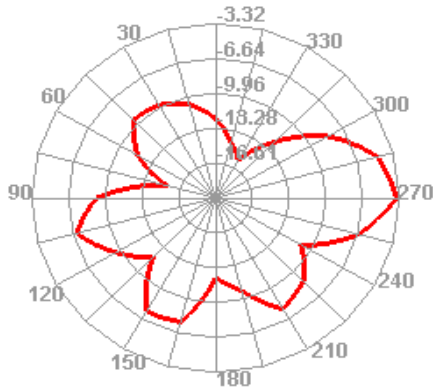

650.000MHz E2

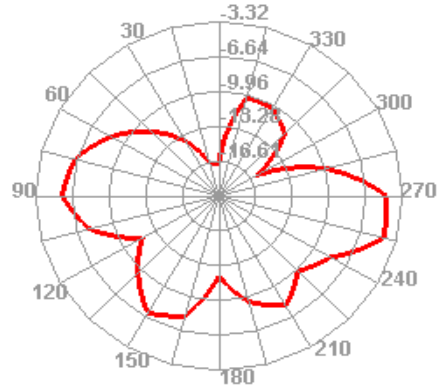

660.000MHz

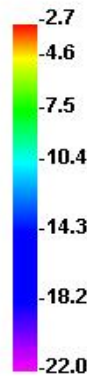
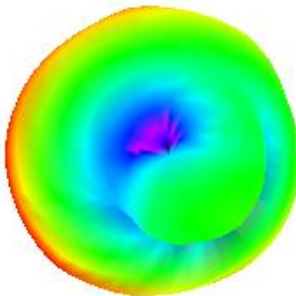

660.000MHz H

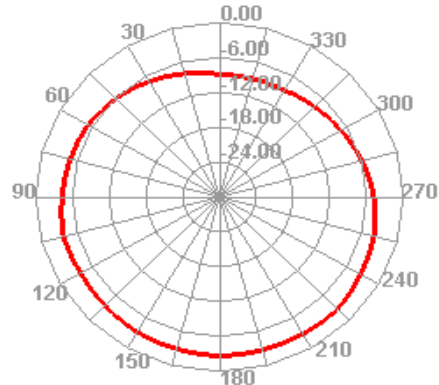

660.000MHz E1

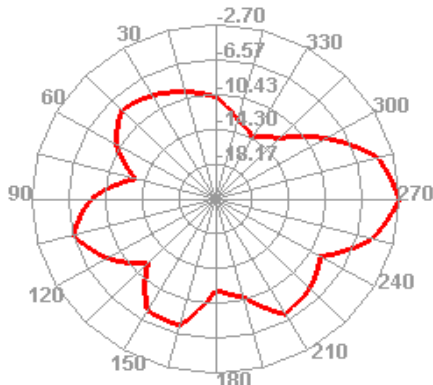

660.000MHz E2

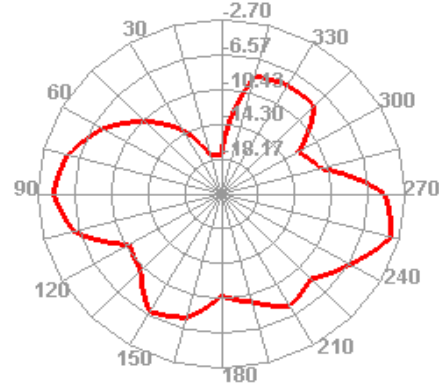

670.000MHz

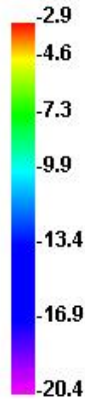
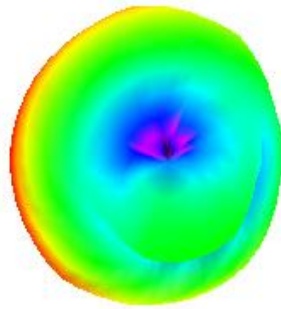

670.000MHz H

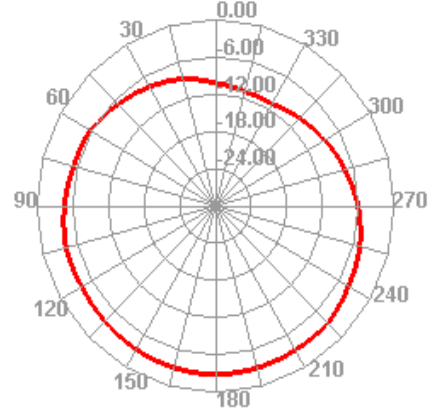

670.000MHz E1

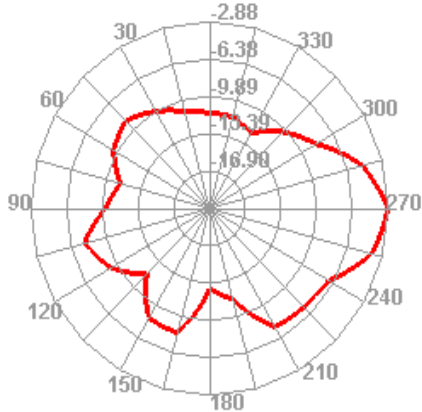

670.000MHz E2

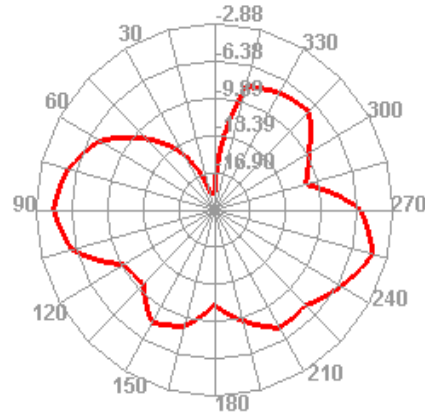

4. Drawing

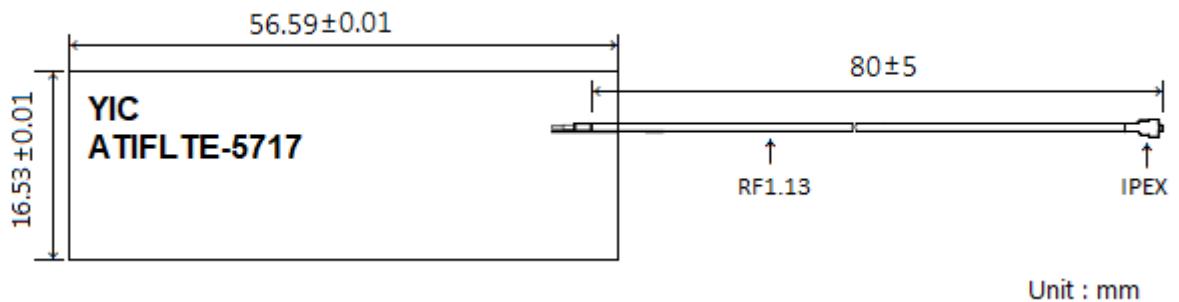

5. Characteristics and Reliability Test

Test Items		Test Condition and Procedure	Requirements
C1	S.W.R.	Set DUT on Network Analyzer; make individual calibration to test	Directive DUT specification
C2	Antenna Gain	Set DUT on Antenna Chamber; make individual calibration to test	Directive DUT specification
M1	Vibration	MIL-STD-202G, 201A Amplitude: 0.03 inch (0.76mm); Freq: 10 to 55 Hz 3 directions; 2 hours for each direction	1. No Visual Damage 2. Frequency Tol.<= 5%
M2	Random Drop	Height: 1.5 Meter; 3 directions; 1 time for each direction	1. No parts separated 2. Frequency Tol.<= 5%
M3	Solderability	MIL-STD-202G, 210F, cond. A Solder iron: 350±10°C; Duration: 5 seconds	1. Mounted on PCB 2. No Visual Damage
M4	Terminal-Pull Test	MIL-STD-202G, 211A, cond. A Holding with individual specification; force applied to axis of terminal	1. Directive DUT specification 2. Frequency Tol.<= 5%
M5	Terminal-Torque Test	MIL-STD-202G, 211A, cond. E Holding with individual specification; applied clockwise and counterclockwise to the axis of terminal	1. Directive DUT specification 2. Frequency Tol.<= 5%
M6	Dimension	Inspection of dimension, color, material, package, surface process	Directive DUT specification
E1	Salt Spray	MIL-STD-202G, 101E, cond. B Temp: 35°C; RH: >= 95%; NaCl solution: >= 5%; Time: 48 hours	After 2 Hours Recovery 1. No Visual Damage 2. Frequency Tol.<= 5%
E2	Humidity	MIL-STD-202G, 103B, cond. B Temp: 40°C; RH: >= 95%; Time: 48 hours	After 2 Hours Recovery 1. No Visual Damage 2. Frequency Tol.<= 5%
E3	Thermal Shock	1 Cycle: - 40°C (30 minutes) to + 80°C (30 minutes) Cycles: 24	After 2 Hours Recovery 1. No Visual Damage 2. Frequency Tol.<= 5%
E4	Life (High Temp.)	MIL-STD-202G, 108A, cond. A Temp: 85°C; Time: 96 hours	After 2 Hours Recovery 1. No Visual Damage 2. Frequency Tol.<= 5%
R1	RoHS	With Reference to IEC 62321:2008 with flow chart	Directive RoHS 2002/95/EC
R2	PFOS	With Reference to USA EPA 3540C:1996 by LC/MS	Directive RoHS 2006/122/EC
R3	PFOA	With Reference to USA EPA 3540C:1996 by LC/MS	Directive RoHS 2006/122/EC

6. Note

6.1 This product specification guarantees the quality of our product as a single unit. Please make sure that your product is evaluated and confirmed against your specifications when our product is mounted to your product.

6.2 The product will get free warranty for one year since the date of purchase users operate in the correct way; users will have to pay cost of the materials and maintaining fee out of the condition.

6.3 Electrostatic sensitive device.Observe precautions for handling.