

DESCRIPTION

The EVM3530-RF-01A is based on MPS's MPM3530 module. The MPM3530 is an easy-to-use, fully integrated, 55V input, 3A, step-down DC/DC power module. The MPM3530 integrates a monolithic DC/DC converter, power inductor, input capacitors, and the necessary resistors and capacitors in a compact QFN package. This total power solution requires only a few external components.

The MPM3530 uses peak-current-mode control to regulate the output voltage. This module provides over-current protection (OCP) with valley-current detection, which is used to prevent current runaway. The MPM3530 also has accurate and reliable over-voltage protection (OVP) and auto-recovery thermal protection. An optional external soft start is available, and enable and power good indicator functions are provided. To increase efficiency, the MPM3530 scales down the switching frequency automatically when load is light

ELECTRICAL SPECIFICATION

Parameter	Symbol	Value	Units
Input Voltage	V _{in}	4.5 - 55	V
Output Voltage	V _{out}	3.3	V
Output Current	I _{out}	3	A

FEATURES

- Wide 4.5V to 55V Operating Input Range
- Wide Output Voltage Adjustable: 1V to 15V
- Programmable Switching Frequency with External SYNC Function
- External Soft Start (SS)
- Over-Current Protection (OCP)
- High Efficiency for Light-Load Operation
- Over-Voltage Protection (OVP) and Thermal Shutdown Protection
- Power Good (PG) Indication
- Meet EN55022 Class B Emission
- Operating Temperature Range: -40°C to 85°C
- Available in a QFN-44 (12mmx10mmx4mm) Package

APPLICATIONS

- Telecom and Networking Systems
- Industrial Equipment

All MPS parts are lead-free, halogen-free, and adhere to the RoHS directive. For MPS green status, please visit the MPS website under Quality Assurance. "MPS", the MPS logo, and "Simple, Easy Solutions" are trademarks of Monolithic Power Systems, Inc. or its subsidiaries.

EVM3530-RF-01A EVALUATION BOARD



(L x W x H) 7.6cm x 7.6cm x 1.3cm

Board Number	MPS IC Number
EVM3530-RF-01A	MPM3530

Efficiency & P_{Loss} vs. Load Current

V_{OUT} = 3.3V

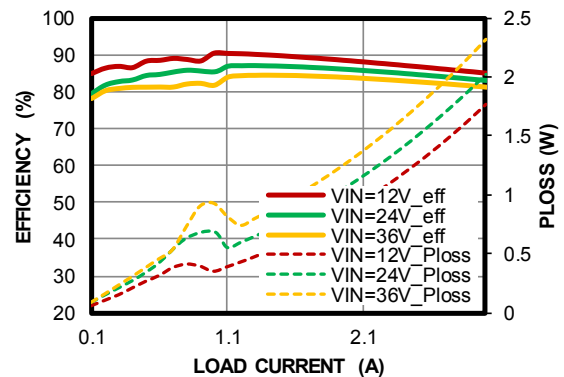



QUICK START GUIDE

1. Connect the positive and negative terminals of the load to the VOUT and GND pins, respectively.
2. Preset the power supply output between 4.5V and 55V and turn off the power supply.
3. Connect the positive and negative terminals of the power supply output to the VIN and GND pins, respectively.
4. Turn the power supply on. The board will start up automatically.

EVALUATION BOARD SCHEMATIC

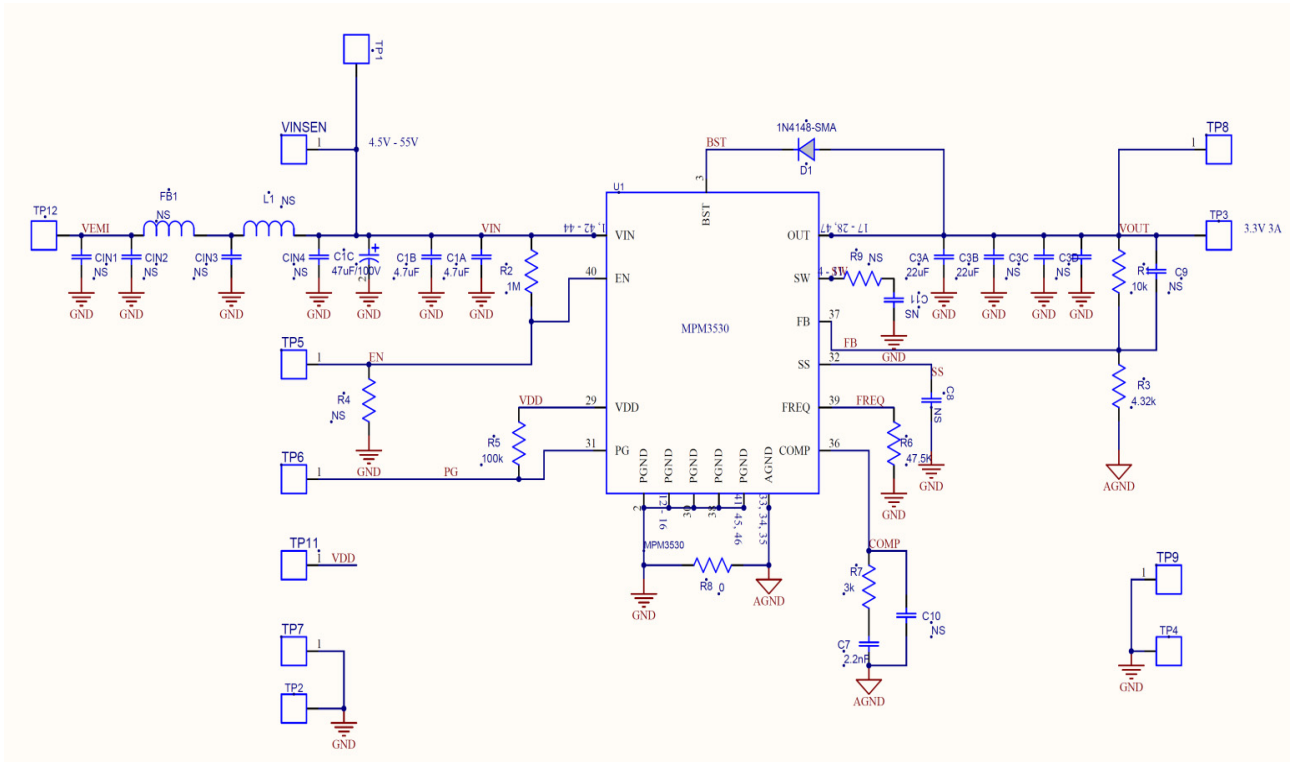

Schematic: Vin = 4.5 - 55V, Vout = 3.3V

EVM3530-RF-01A BILL OF MATERIALS

Qty	RefDes	Value	Description	Package	Manufacturer	Manufacturer P/N
2	C1A, C1B	4.7 μ F	Ceramic Caps. 100V	1210	muRata	GRM32DC72A475KE01K
1	C1C	47 μ F	Electrolytic Cap. 80V	SMD 10x10mm	Panasonic	EEH-ZC1K470P
2	C3A, C3B	22 μ F	Ceramic Caps. 25V	1206	muRata	GRM31CR61E226KE15K
2	C3C, C3D	NS				
1	C7	2.2nF	Ceramic Caps. 16V	0603	muRata	GRM31CR61E063KE07J
4	C8, C9, C10, C11	NS				
1	D1	NS	Diode, 100V, 150mA	SOD-123		
1	R1	10k Ω	Film resistor, 1%	0603	YAGEO	RC0603FR-0710KL
1	R2	1M Ω	Film resistor, 1%	0603	YAGEO	RC0603FR-071ML
2	R4, R9	NS				
1	R3	4.32k Ω	Film resistor, 1%	0603	YAGEO	RC0603FR-074K32L
1	R5	100k Ω	Film resistor, 1%	0603	YAGEO	RC0603FR-07100KL
1	R6	47.5k Ω	Film resistor, 1%	0603	YAGEO	RC0603FR-0747K5L
1	R7	3k Ω	Film resistor, 1%	0603	YAGEO	RC0603FR-073KL
1	R8	0	Film resistor, 1%	0603	YAGEO	
1	U1		55V, 3A power module	QFN- 10x12mm	MPS	MPM3530GRF
7	TP1, TP2, TP3, TP4, TP5, TP6, TP7		Test point-1mm		Any	
1	CN1		connector 2x20, 2.54mm, 90 degree		Any	
4	CN2, CN3, CN4, CN5		Test point-2mm		Any	

EVB TEST RESULTS

Performance waveforms are tested on the evaluation board.

$V_{IN} = 24V$, $V_{OUT} = 3.3V$, $T_A = 25^\circ C$, unless otherwise noted.

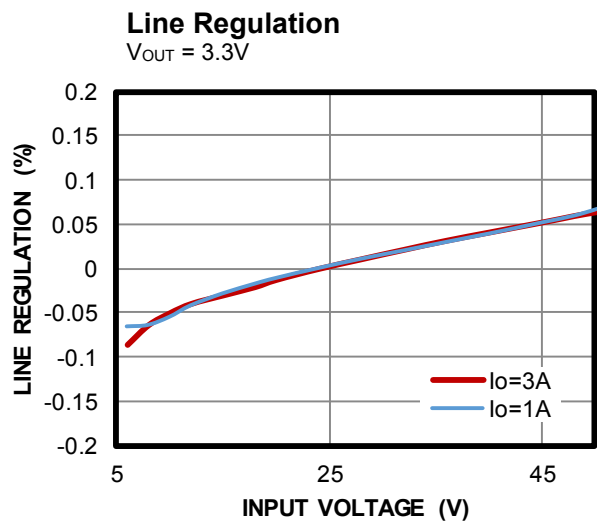
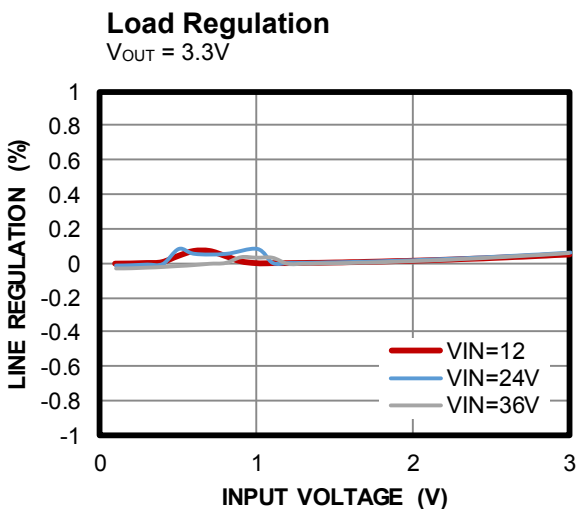
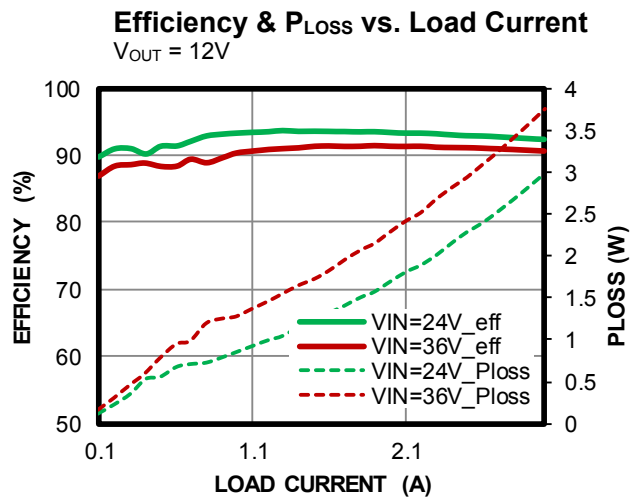
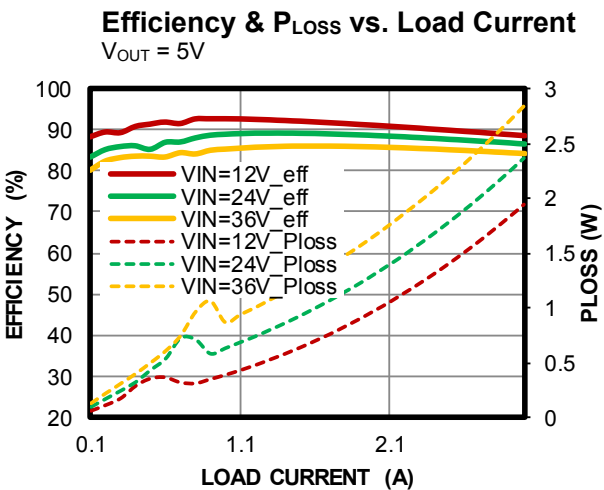
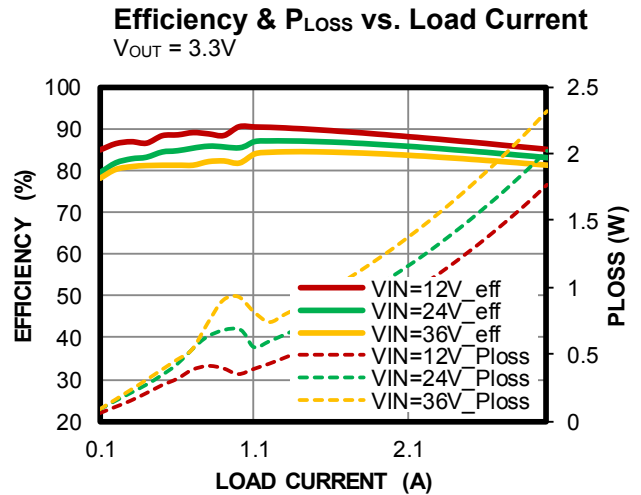
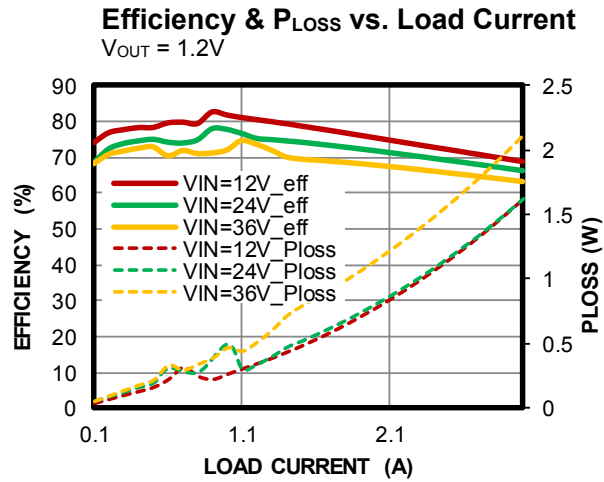

TYPICAL PERFORMANCE CHARACTERISTICS (continued)

Performance waveforms are tested on the evaluation board of the Design Example section.
 $V_{IN} = 24V$, $T_A = 25^\circ C$, unless otherwise noted.

Start-Up through VIN

$V_{OUT} = 3.3V$, $I_{OUT} = 0A$

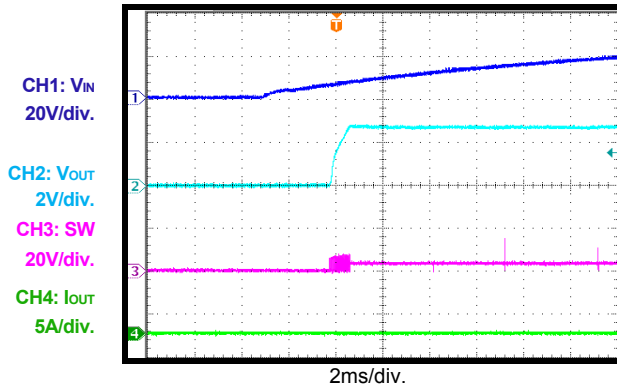

Start-Up through VIN

$V_{OUT} = 3.3V$, $I_{OUT} = 3A$

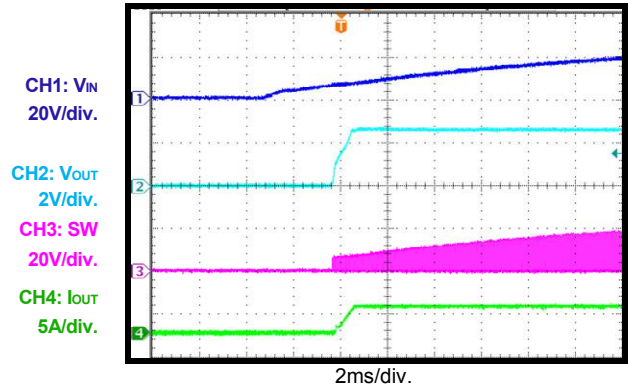

Output Ripple

$V_{OUT} = 3.3V$, $I_{OUT} = 0A$, 4x22 μF caps

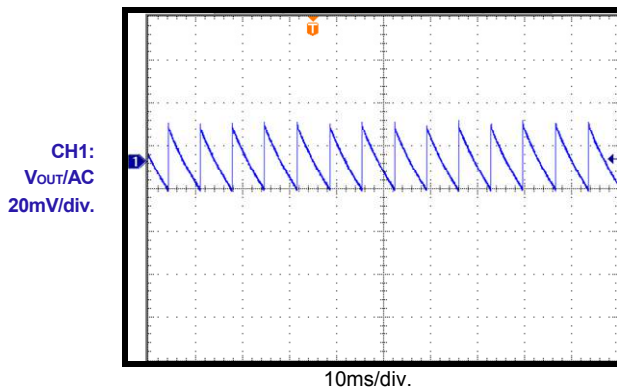

Output Ripple

$V_{OUT} = 3.3V$, $I_{OUT} = 3A$, 4x22 μF caps

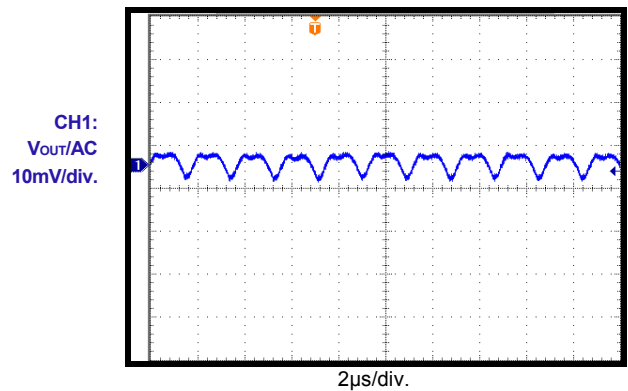

Load Transient Response

$V_{OUT} = 3.3V$, $I_{OUT} = 1.5 - 3A$, 4x22 μF caps

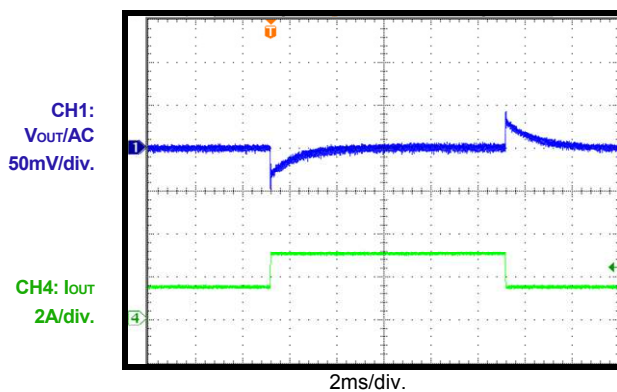

Load Transient Response

$V_{OUT} = 3.3V$, $I_{OUT} = 0 - 3A$, 4x22 μF caps

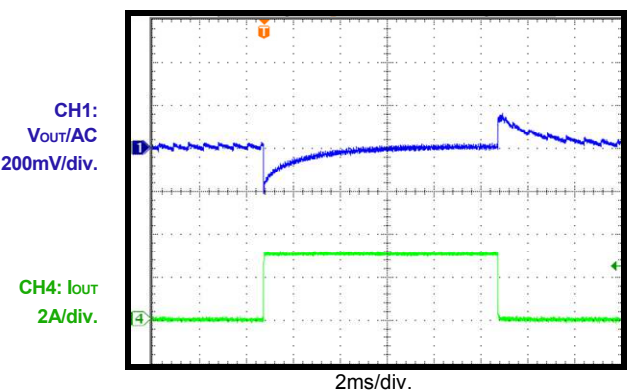

TYPICAL PERFORMANCE CHARACTERISTICS (continued)

Performance waveforms are tested on the evaluation board of the Design Example section.
 $V_{IN} = 12V$, $T_A = 25^\circ C$, unless otherwise noted.

Conducted Emission, EN55022 Class B

$V_{IN}=12V$, $V_{OUT} = 3.3V$

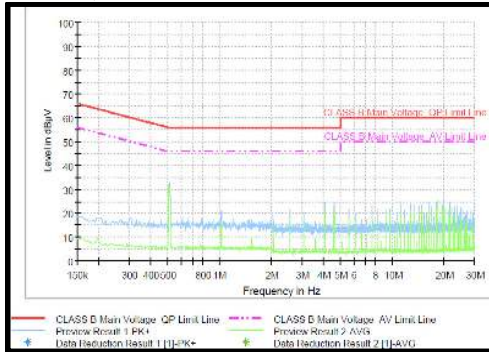

1s/div.

Radiated Emission, EN55022 Class B

$V_{IN}=12V$, $V_{OUT} = 3.3V$

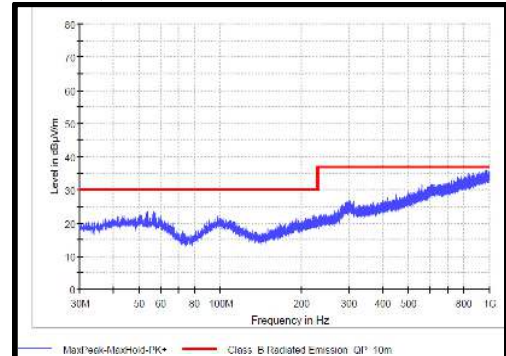

4s/div.

EMI TEST CIRCUIT

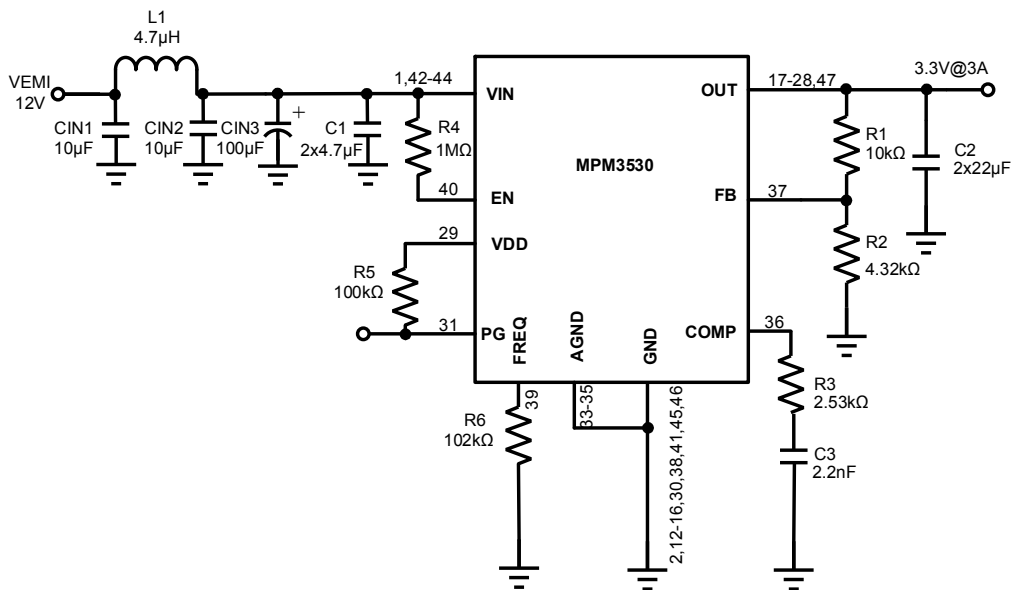

PRINTED CIRCUIT BOARD LAYOUT

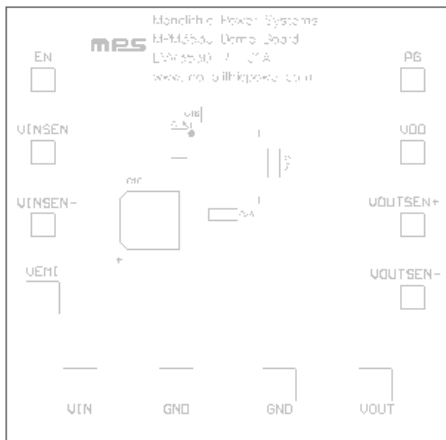

Figure 1: Top Silk Layer

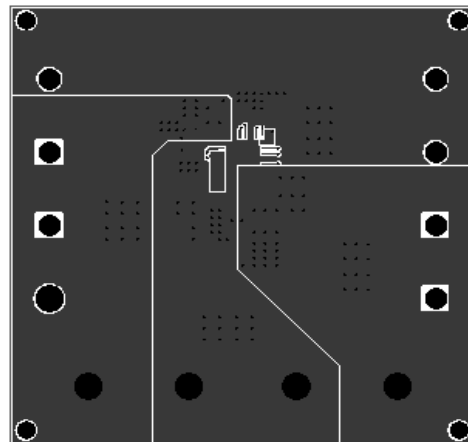

Figure 2: Top Layer

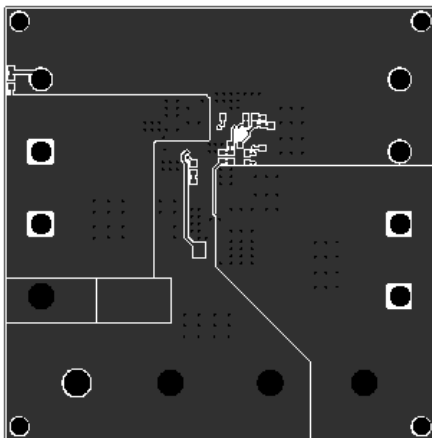

Figure 3: Bottom Layer

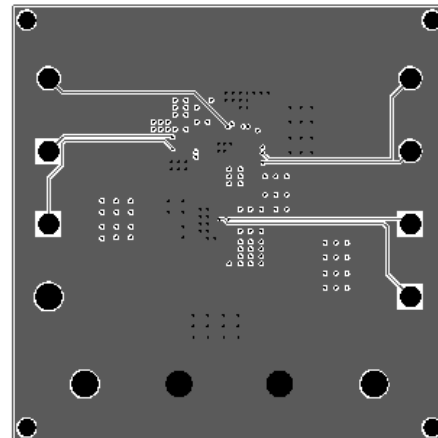

Figure 4: Inner Layer 1

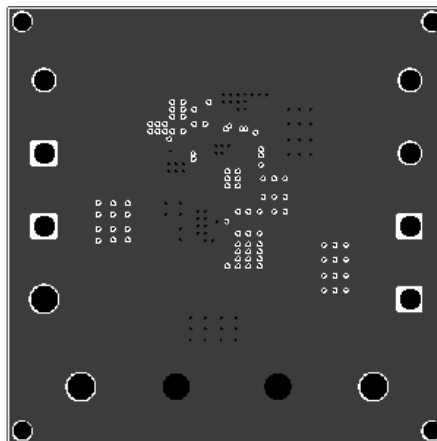

Figure 5: Inner Layer 2



Revision History

Revision #	Revision Date	Description	Pages Updated
1.0	9/22/2018	Initial Release	-
1.1	11/13/2020	Updated EMI waveforms and EMI test circuit	7

NOTICE: The information in this document is subject to change without notice. Please contact MPS for current specifications. Users should warrant and guarantee that third party Intellectual Property rights are not infringed upon when integrating MPS products into any application. MPS will not assume any legal responsibility for any said applications.