

FTP-3/18S - Test plug



3069986

<https://www.phoenixcontact.com/us/products/3069986>

Please be informed that the data shown in this PDF document is generated from our online catalog. Please find the complete data in the user documentation. Our general terms of use for downloads are valid.

Test plug, number of positions: 18, color: gray



Your advantages

- Easy and time saving, thanks to functional grouping of switching operations
- Cost-effective, thanks to the tailored, modular design and use of standardized CLIPLINE complete accessories
- Space saving, thanks to offset test socket arrangement
- Maximum safety with leading and automatic transformer short circuit
- The automatically generated transformer short circuit and the shock-proof design ensure the highest degree of safety during measurement
- The integrated, robust switch contact is designed for the most stringent demands, and the use of high-quality materials ensures the transmission of signal currents, even after multiple actuations

Commercial data

Item number	3069986
Packing unit	1 pc
Minimum order quantity	1 pc
Sales key	BE06
Product key	BE6113
GTIN	4055626396101
Weight per piece (including packing)	849.71 g
Weight per piece (excluding packing)	646.58 g
Customs tariff number	85366990
Country of origin	PL

FTP-3/18S - Test plug

3069986

<https://www.phoenixcontact.com/us/products/3069986>



Technical data

Product properties

Product type	Test plug terminal block
Number of positions	18
Pitch	8.2 mm
Potentials	18

Connection data

Test socket torque	0.5
--------------------	-----

Dimensions

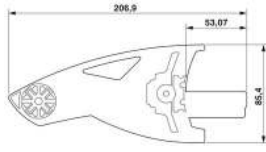
Dimensional drawing	
Width	172.4 mm
Height	86 mm
Pitch	8.2 mm

Material specifications

Color	gray
Flammability rating according to UL 94	V0
Insulating material	PA

Environmental and real-life conditions

Ambient conditions

Ambient temperature (operation)	-60 °C ... 105 °C (max. short-term operating temperature RTI Elec.)
Ambient temperature (storage/transport)	-25 °C ... 60 °C (for a short time, not exceeding 24 h, -60 °C to +70 °C)
Ambient temperature (assembly)	-5 °C ... 70 °C
Ambient temperature (actuation)	-5 °C ... 70 °C
Permissible humidity (storage/transport)	30 % ... 70 %

FTP-3/18S - Test plug

3069986

<https://www.phoenixcontact.com/us/products/3069986>



Drawings

Circuit diagram

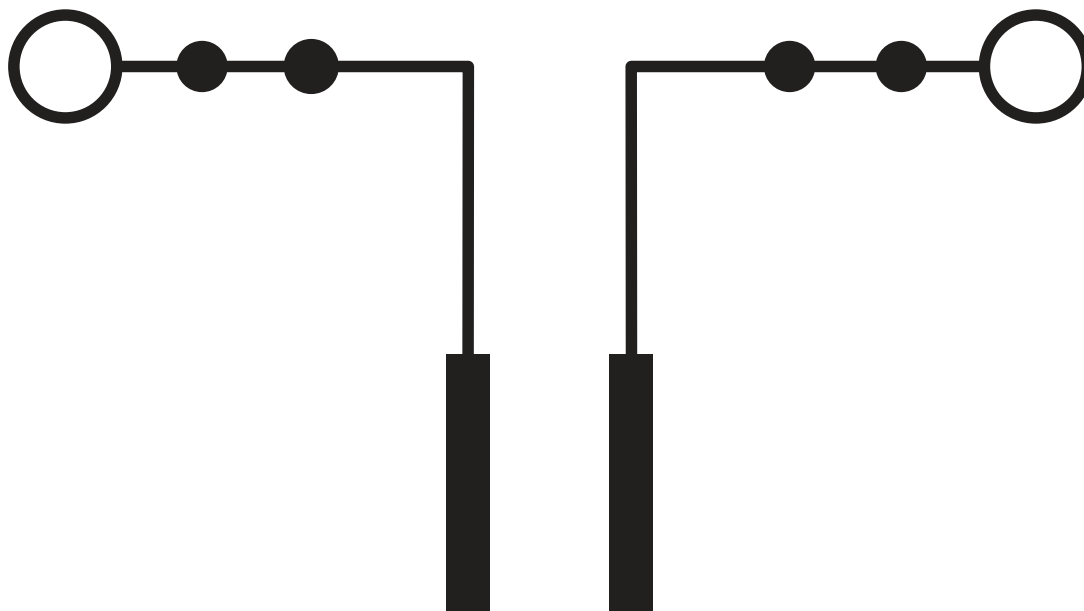

Dimensional drawing

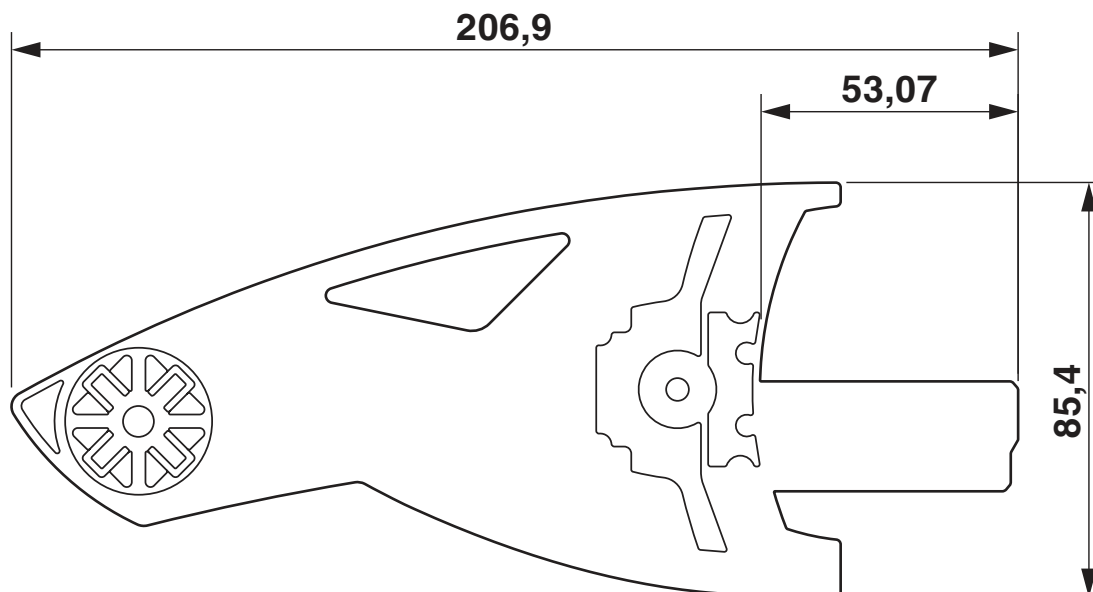

FTP-3/18S - Test plug



3069986

<https://www.phoenixcontact.com/us/products/3069986>

Approvals

🔗 To download certificates, visit the product detail page: <https://www.phoenixcontact.com/us/products/3069986>



EAC

Approval ID: RU C-DE.BL08.B.00511



cULus Recognized

Approval ID: E60425

FTP-3/18S - Test plug



3069986

<https://www.phoenixcontact.com/us/products/3069986>

Classifications

ECLASS

ECLASS-11.0	27440313
ECLASS-12.0	27440313
ECLASS-13.0	27440313

ETIM

ETIM 8.0	EC002255
----------	----------

UNSPSC

UNSPSC 21.0	20122000
-------------	----------

FTP-3/18S - Test plug

3069986

<https://www.phoenixcontact.com/us/products/3069986>



Accessories

i Note: Applying some accessories below might limit this product.

FBS 2-8 - Plug-in bridge

3030284

<https://www.phoenixcontact.com/us/products/3030284>



Plug-in bridge, pitch: 8.2 mm, number of positions: 2, color: red

i Max. current carrying capacity: 24 A

FBS 3-8 - Plug-in bridge

3030297

<https://www.phoenixcontact.com/us/products/3030297>



Plug-in bridge, pitch: 8.2 mm, number of positions: 3, color: red

i Max. current carrying capacity: 24 A

FTP-3/18S - Test plug

3069986

<https://www.phoenixcontact.com/us/products/3069986>



FBS 4-8 - Plug-in bridge

3030307

<https://www.phoenixcontact.com/us/products/3030307>



Plug-in bridge, pitch: 8.2 mm, number of positions: 4, color: red

 Max. current carrying capacity: 24 A

FBS 5-8 - Plug-in bridge

3030310

<https://www.phoenixcontact.com/us/products/3030310>



Plug-in bridge, pitch: 8.2 mm, number of positions: 5, color: red

 Max. current carrying capacity: 24 A

FTP-3/18S - Test plug

3069986

<https://www.phoenixcontact.com/us/products/3069986>



FBS 6-8 - Plug-in bridge

3032470

<https://www.phoenixcontact.com/us/products/3032470>



Plug-in bridge, pitch: 8.2 mm, number of positions: 6, color: red

 Max. current carrying capacity: 24 A

FBS 10-8 - Plug-in bridge

3030323

<https://www.phoenixcontact.com/us/products/3030323>



Plug-in bridge, pitch: 8.2 mm, number of positions: 10, color: red

 Max. current carrying capacity: 24 A

FTP-3/18S - Test plug

3069986

<https://www.phoenixcontact.com/us/products/3069986>



FBSRH 2-8 - Short-circuit connector

3033802

<https://www.phoenixcontact.com/us/products/3033802>



Short-circuit connector, pitch: 8.2 mm, number of positions: 2, color: red

 Max. current carrying capacity: 24 A

FBSRH 3-8 - Short-circuit connector

3033803

<https://www.phoenixcontact.com/us/products/3033803>



Short-circuit connector, pitch: 8.2 mm, number of positions: 3, color: red

 Max. current carrying capacity: 24 A

FTP-3/18S - Test plug

3069986

<https://www.phoenixcontact.com/us/products/3069986>



FBSRH 4-8 - Short-circuit connector

3033804

<https://www.phoenixcontact.com/us/products/3033804>



Short-circuit connector, pitch: 8.2 mm, number of positions: 4, color: red

 Max. current carrying capacity: 24 A

FBS 1/3-8 - Plug-in bridge

3032363

<https://www.phoenixcontact.com/us/products/3032363>



Plug-in bridge, pitch: 8.2 mm, number of positions: 3, pin assignment: 1,3, color: red

 Max. current carrying capacity: 24 A

FTP-3/18S - Test plug

3069986

<https://www.phoenixcontact.com/us/products/3069986>



FBS 2-8 CT - Plug-in bridge

3033830

<https://www.phoenixcontact.com/us/products/3033830>



Plug-in bridge, pitch: 8.2 mm, number of positions: 2, color: orange

 Max. current carrying capacity: 24 A

FBS 3-8 CT - Plug-in bridge

3033831

<https://www.phoenixcontact.com/us/products/3033831>



Plug-in bridge, pitch: 8.2 mm, number of positions: 3, color: orange

 Max. current carrying capacity: 24 A

FTP-3/18S - Test plug

3069986

<https://www.phoenixcontact.com/us/products/3069986>



FBS 4-8 CT - Plug-in bridge

3033832

<https://www.phoenixcontact.com/us/products/3033832>



Plug-in bridge, pitch: 8.2 mm, number of positions: 4, color: orange

 Max. current carrying capacity: 24 A

FBS 10-8 CT - Plug-in bridge

3033833

<https://www.phoenixcontact.com/us/products/3033833>



Plug-in bridge, pitch: 8.2 mm, number of positions: 10, color: orange

 Max. current carrying capacity: 24 A

FTP-3/18S - Test plug

3069986

<https://www.phoenixcontact.com/us/products/3069986>



FBS 2-8 BU - Plug-in bridge

3032567

<https://www.phoenixcontact.com/us/products/3032567>



Plug-in bridge, pitch: 8.2 mm, number of positions: 2, color: blue

 Max. current carrying capacity: 24 A

FBS 3-8 BU - Plug-in bridge

3032570

<https://www.phoenixcontact.com/us/products/3032570>



Plug-in bridge, pitch: 8.2 mm, number of positions: 3, color: blue

 Max. current carrying capacity: 24 A

FTP-3/18S - Test plug

3069986

<https://www.phoenixcontact.com/us/products/3069986>



FBS 4-8 BU - Plug-in bridge

3032583

<https://www.phoenixcontact.com/us/products/3032583>



Plug-in bridge, pitch: 8.2 mm, number of positions: 4, color: blue

 Max. current carrying capacity: 24 A

FBS 5-8 BU - Plug-in bridge

3032596

<https://www.phoenixcontact.com/us/products/3032596>



Plug-in bridge, pitch: 8.2 mm, number of positions: 5, color: blue

 Max. current carrying capacity: 24 A

FTP-3/18S - Test plug

3069986

<https://www.phoenixcontact.com/us/products/3069986>



FBS 6-8 BU - Plug-in bridge

3032677

<https://www.phoenixcontact.com/us/products/3032677>



Plug-in bridge, pitch: 8.2 mm, number of positions: 6, color: blue

 Max. current carrying capacity: 24 A

FBS 10-8 BU - Plug-in bridge

3032606

<https://www.phoenixcontact.com/us/products/3032606>



Plug-in bridge, pitch: 8.2 mm, number of positions: 10, color: blue

 Max. current carrying capacity: 24 A

FTP-3/18S - Test plug

3069986

<https://www.phoenixcontact.com/us/products/3069986>



C-FCI 1,5/M3 - Fork-type cable lug

3240032

<https://www.phoenixcontact.com/us/products/3240032>



Fork-type cable lug, red, 0.5 - 1.5 mm², M3

C-FCI 2,5/M3 - Fork-type cable lug

3240037

<https://www.phoenixcontact.com/us/products/3240037>



Fork-type cable lug, blue, 1.5 - 2.5 mm², M3

FTP-3/18S - Test plug

3069986

<https://www.phoenixcontact.com/us/products/3069986>



C-RCI 1,5/M3 - Ring cable lug

3240016

<https://www.phoenixcontact.com/us/products/3240016>



Ring cable lug, red, 0.5 ... 1.5 mm², M3

C-RCI 2,5/M3 - Ring cable lug

3240021

<https://www.phoenixcontact.com/us/products/3240021>



Ring cable lug, blue, 1.5 ... 2.5 mm², M3

FTP-3/18S - Test plug

3069986

<https://www.phoenixcontact.com/us/products/3069986>



FAME-BAG 260 - Shoulder bag

3069520

<https://www.phoenixcontact.com/us/products/3069520>



Shoulder bag, For FAME connectors with a width of up to 261 mm, length: 220 mm, width: 290 mm, height: 220 mm, color: black

FTP SCREW M3X4,5 - Screw

3069467

<https://www.phoenixcontact.com/us/products/3069467>



Screw, for attaching cable lugs to FAME test plugs, with cover, without test point, length: 4.5 mm, height: 4.5 mm, color: silver/black

FTP-3/18S - Test plug

3069986

<https://www.phoenixcontact.com/us/products/3069986>



PSBJ-URTK 6 FARBLOS - Female test connector

3026450

<https://www.phoenixcontact.com/us/products/3026450>



Female test connector, number of positions: 1, color: transparent

PSBJ-URTK 6 RD - Female test connector

3026719

<https://www.phoenixcontact.com/us/products/3026719>



Female test connector, number of positions: 1, color: red

FTP-3/18S - Test plug

3069986

<https://www.phoenixcontact.com/us/products/3069986>



PSBJ-URTK 6 BU - Female test connector

3026434

<https://www.phoenixcontact.com/us/products/3026434>



Female test connector, number of positions: 1, color: blue

PSBJ-URTK 6 YE - Female test connector

3026405

<https://www.phoenixcontact.com/us/products/3026405>



Female test connector, number of positions: 1, color: yellow

FTP-3/18S - Test plug

3069986

<https://www.phoenixcontact.com/us/products/3069986>



PSBJ-URTK 6 GN - Female test connector

3026418

<https://www.phoenixcontact.com/us/products/3026418>



Female test connector, number of positions: 1, color: green

PSBJ-URTK 6 VT - Female test connector

3026421

<https://www.phoenixcontact.com/us/products/3026421>



Female test connector, number of positions: 1, color: violet

FTP-3/18S - Test plug

3069986

<https://www.phoenixcontact.com/us/products/3069986>



PSBJ-URTK 6 GY - Female test connector

3026612

<https://www.phoenixcontact.com/us/products/3026612>



Female test connector, number of positions: 1, color: gray

PSBJ-URTK 6 BK - Female test connector

3026447

<https://www.phoenixcontact.com/us/products/3026447>



Female test connector, number of positions: 1, color: black

FTP-3/18S - Test plug

3069986

<https://www.phoenixcontact.com/us/products/3069986>



PSBJ-URTK 6 BN - Female test connector

3026971

<https://www.phoenixcontact.com/us/products/3026971>



Female test connector, number of positions: 1, color: brown

PSBJ-URTK 6 WH - Female test connector

3026448

<https://www.phoenixcontact.com/us/products/3026448>



Female test connector, number of positions: 1, color: white

FTP-3/18S - Test plug

3069986

<https://www.phoenixcontact.com/us/products/3069986>



ZB 8:UNBEDRUCKT - Zack marker strip

1052002

<https://www.phoenixcontact.com/us/products/1052002>



Zack marker strip, Strip, white, unlabeled, can be labeled with: CMS-P1-PLOTTER, PLOTMARK, mounting type: snapped, for terminal block width: 8.2 mm, lettering field size: 10.5 x 8.15 mm, Number of individual labels: 10

ZB 8 CUS - Zack marker strip

0825011

<https://www.phoenixcontact.com/us/products/0825011>



Zack marker strip, can be ordered: Strip, white, labeled according to customer specifications, mounting type: snap into tall marker groove, for terminal block width: 8.2 mm, lettering field size: 10.5 x 8.15 mm, Number of individual labels: 10

FTP-3/18S - Test plug

3069986

<https://www.phoenixcontact.com/us/products/3069986>



UC-TM 8 - Marker for terminal blocks

0818072

<https://www.phoenixcontact.com/us/products/0818072>



Marker for terminal blocks, Sheet, white, unlabeled, can be labeled with: BLUEMARK ID COLOR, BLUEMARK ID, BLUEMARK CLED, PLOTMARK, CMS-P1-PLOTTER, mounting type: snapped, for terminal block width: 8.2 mm, lettering field size: 7.6 x 10.5 mm, Number of individual labels: 56

UC-TM 8 CUS - Marker for terminal blocks

0824597

<https://www.phoenixcontact.com/us/products/0824597>



Marker for terminal blocks, can be ordered: by sheet, white, labeled according to customer specifications, mounting type: snap into tall marker groove, for terminal block width: 8.2 mm, lettering field size: 7.6 x 10.5 mm, Number of individual labels: 56

FTP-3/18S - Test plug

3069986

<https://www.phoenixcontact.com/us/products/3069986>



UCT-TM 8 - Marker for terminal blocks

0828740

<https://www.phoenixcontact.com/us/products/0828740>



Marker for terminal blocks, Sheet, white, unlabeled, can be labeled with: TOPMARK NEO, TOPMARK LASER, BLUEMARK ID COLOR, BLUEMARK ID, BLUEMARK CLED, THERMOMARK PRIME, THERMOMARK CARD 2.0, THERMOMARK CARD, mounting type: snapped, for terminal block width: 8.2 mm, lettering field size: 7.6 x 10.5 mm, Number of individual labels: 42

UCT-TM 8 CUS - Marker for terminal blocks

0829616

<https://www.phoenixcontact.com/us/products/0829616>



Marker for terminal blocks, can be ordered: by sheet, white, labeled according to customer specifications, mounting type: snap into tall marker groove, for terminal block width: 8.2 mm, lettering field size: 7.6 x 10.5 mm, Number of individual labels: 42

FTP-3/18S - Test plug

3069986

<https://www.phoenixcontact.com/us/products/3069986>



ZB 8,LGS:FORTL.ZAHLEN - Zack marker strip

1052015

<https://www.phoenixcontact.com/us/products/1052015>



Zack marker strip, Strip, white, labeled, can be labeled with: CMS-P1-PLOTTER, printed horizontally: consecutive numbers 1 ... 10, 11 ... 20, etc. up to 91 ... 100, mounting type: snapped, for terminal block width: 8.2 mm, lettering field size: 10. 5 x 8.15 mm, Number of individual labels: 10

ZB 8,QR:FORTL.ZAHLEN - Zack marker strip

1052028

<https://www.phoenixcontact.com/us/products/1052028>



Zack marker strip, Strip, white, labeled, can be labeled with: CMS-P1-PLOTTER, Printed vertically: consecutive numbers 1 ... 10, 11 ... 20, etc. up to 91 ... 100, mounting type: snapped, for terminal block width: 8.2 mm, lettering field size: 10. 5 x 8.15 mm, Number of individual labels: 10

FTP-3/18S - Test plug

3069986

<https://www.phoenixcontact.com/us/products/3069986>



ZB 8,LGS:L1-N,PE - Marker for terminal blocks

1052413

<https://www.phoenixcontact.com/us/products/1052413>



Marker for terminal blocks, Strip, white, labeled, can be labeled with: CMS-P1-PLOTTER, horizontal: L1, L2, L3, N, PE, L1, L2, L3, N, PE, mounting type: snapped, for terminal block width: 8.2 mm, lettering field size: 10.5 x 8.15 mm, Number of individual labels: 10

TMT (EX9,5)R - Marker for terminal blocks

0828295

<https://www.phoenixcontact.com/us/products/0828295>



Marker for terminal blocks, Roll, white, unlabeled, can be labeled with: THERMOMARK E.300 (D)/600 (D), THERMOMARK ROLL 2.0, THERMOMARK ROLL, THERMOMARK ROLL X1, THERMOMARK ROLLMASTER 300/600, THERMOMARK X1.2, mounting type: snapped, snap into tall marker groove, for terminal block width: 30000 mm, lettering field size: 9.5 x 50000 mm, Number of individual labels: 1

FTP-3/18S - Test plug

3069986

<https://www.phoenixcontact.com/us/products/3069986>



US-TM 100 - Marker for terminal blocks

0829255

<https://www.phoenixcontact.com/us/products/0829255>



Marker for terminal blocks, Card, white, unlabeled, can be labeled with: BLUEMARK ID COLOR, BLUEMARK ID, THERMOMARK PRIME, THERMOMARK CARD 2.0, THERMOMARK CARD, mounting type: snapped, lettering field size: 104 x 9.8 mm, Number of individual labels: 13

RSCWE 6-3/18 - Test terminal strip

3969957

<https://www.phoenixcontact.com/us/products/3969957>



Test terminal strip, nom. voltage: 400 V, number of connections: 36, number of positions: 18, connection method: Ring cable lug, 1 level, Rated cross section: 6 mm², mounting type: Wall mounting, color: gray

Phoenix Contact 2023 © - all rights reserved
<https://www.phoenixcontact.com>

Phoenix Contact USA
586 Fulling Mill Road
Middletown, PA 17057, United States
(+717) 944-1300
info@phoenixcon.com