

9Vdc – 36Vdc input; +15V, -15V Dual Output, 0.3A 9W Output

SHHN000A3 HAMMERHEAD* Series; DC-DC Converter Power Modules



RoHS Compliant

Applications

- Hybrid power architectures
- Industrial markets

Features

- Compliant to RoHS Directive 2011/65/EU and amended Directive (EU) 2015/863. (-Z versions)
- Compliant to REACH Directive (EC) No 1907/2006
- Wide Input Voltage Range, 9Vdc to 36Vdc
- No minimum load for no damage operation
- Constant switching frequency
- Low output ripple and noise
- Small Size and low profile, follows industry standard 1x1 footprint
27.9mm x 24.4mm x 8.5mm (MAX)
(1.10 x 0.96 x 0.335 in)
- Surface mount (SMT) or Through hole (TH)
- Reflow process compliant, both SMT and TH versions
- Positive and Negative Remote On/Off logic
- Output overcurrent, overvoltage protection
- Over-temperature protection
- Wide operating temperature range (-40°C to 85°C)
- ANSI/UL* 62368-1 and CAN/CSA† C22.2 No. 62368-1 Recognized, DIN VDE‡ 0868-1/A11:2017 (EN62368-1:2014/A11:2017)
- CE mark meets 2014/35/EU directive§
- Withstands 1600Vdc Isolation Voltage.
- ISO** 9001 and ISO 14001 certified manufacturing facilities

Description

The SHHN000A3A HAMMERHEAD* series power modules are isolated dc-dc converters that designed to operate over a wide input voltage range of 9 Vdc -36Vdc and provide a set of regulated dual polarity output voltages at +15.0Vdc and -15.0Vdc. The outputs are fully isolated from the input, allowing versatile polarity configurations and grounding connections. The modules exhibit a minimum efficiency of 84.0% at full load and nominal input. Built-in filtering for both input and output minimizes external filtering components. The module is fully self-protected with output over-current and over-voltage, over-temperature and input under voltage shutdown control. Optional features include negative or positive on/off logic and SMT connections.

*Trademark of General Electric Corporation

UL is a registered trademark of Underwriters Laboratories, Inc.

† CSA is a registered trademark of Canadian Standards Association.

‡ VDE is a trademark of Verband Deutscher Elektrotechniker e.V.

** ISO is a registered trademark of the International Organization of Standards

The PMBus name and logo are registered trademarks of the System Management Interface Forum (SMIF)

SHHN000A3 Series; DC-DC Converter Power Modules

9Vdc – 36Vdc input; +15V, -15V Dual Output, 0.3A 9W Output

Absolute Maximum Ratings

Stresses in excess of the absolute maximum ratings will cause permanent damage to the device. These are absolute stress ratings only, functional operation of the device is not desired at these or any other conditions in excess of those given in the operations sections of the Datasheet. Exposure to absolute maximum ratings for extended periods can adversely affect the device reliability.

Parameter	Device	Symbol	Min	Max	Unit
Input Voltage (Continuous)	All	V_{IN}	-0.3	40	Vdc
Transient (1s) – No damage	All	$V_{IN,trans}$	-0.3	50	Vdc
Operating Ambient Temperature (see Thermal Considerations section)	All	T_A	-40	85	°C
Storage Temperature	All	T_{stg}	-55	125	°C
Altitude	All			4000	m
I/O Isolation Voltage (100% factory Hi-Pot tested)	All	—		1600	Vdc

Electrical Specifications

Unless otherwise indicated, specifications apply over all operating input voltage, resistive load, and temperature conditions .

Parameter	Device	Symbol	Min	Typ	Max	Unit
Operating Input Voltage	All	V_{IN}	9	—	36	Vdc
Maximum Input Current ($V_{IN}=9$ to 36V, $I_{O1}=I_{O,max}$, $I_{O2}=I_{O2,max}$)	All	I_{IN}			1.3	Adc
Input No Load Current ($V_{IN} = 24$ Vdc, $I_O = 0$, module enabled)	$V_{O1,O2} = ON$	$I_{IN,No\ load}$		30		mA
Input Stand-by Current ($V_{IN} = 24$ Vdc, module disabled)	All	$I_{IN,stand-by}$		9		mA
Inrush Transient	All	I_1^2t			0.05	A ² s
Input Reflected Ripple Current, peak-to-peak (5Hz to 20MHz, 1 μ H source impedance; $V_{IN} = 0$ to 36V, I_{O1} & $I_{O2} = I_{O,max}$; See Test Configurations)	All			30		mAp-p
Input Ripple Rejection (120Hz)	All			40		dB

SHHN000A3 Series; DC-DC Converter Power Modules

9Vdc – 36Vdc input; +15V, -15V Dual Output, 0.3A 9W Output

Electrical Specifications (continued)

Parameter	Device	Symbol	Min	Typ	Max	Unit
Output Voltage Set-point 1 ($V_{IN}=9$ to $36V_{dc}$, $I_O=I_{O,max}$, $T_A=25^\circ C$)	+15.0 V _{O1}	V _{O1,set}	-1.5%		+1.5%	%V _O
Output Voltage Set-point 2 ($V_{IN}=9$ to $36V_{dc}$, $I_O=I_{O,max}$, $T_A=25^\circ C$)	-15.0 V _{O2}	V _{O2,set}	-1.5%		+1.5%	%V _O
Output Voltage Accuracy (Over all operating input voltage, resistive load, and temperature conditions until end of life)	All	V _{O1,02}	-3.0	—	+3.0	%V _{O,set}
Output Regulation Line ($V_{IN}=V_{IN,min}$ to $V_{IN,max}$) Load ($I_O=10\%$ to $I_{O,max}$) Temperature ($T_{ref}=T_{A,min}$ to $T_{A,max}$)	All All All		— — —	0.05 0.05 —	0.3 0.3 1.0	%V _{O,set} %V _{O,set} %V _{O,set}
Cross Regulation (10-100% Load on each output)**	All				5	%V _{O,set}
Output Ripple and Noise on nominal output Measured with 10uF Tantalum 1uF ceramic ($V_{IN}=24 V_{dc}$, $I_O=100\%I_{O,max}$, $T_A=25^\circ C$) RMS (5Hz to 20MHz bandwidth) Peak-to-Peak (5Hz to 20MHz bandwidth)	All		— —	50 200		mV _{rms} mV _{pk-pk}
External Capacitance	All	C _{O,max}	0	—	470	μF
Output Current -1	All	I _{O1}	0	—	0.3	A _{dc}
Output Current - 2	All	I _{O2}	0	—	0.3	A _{dc}
Output Current Limit Inception (Hiccup Mode)	All	I _{O,lim}		0.6		A _{dc}
Output Short-Circuit Current V _O ≤ 250 mV @ 25°C	All	I _{O,s/c}	—	0.127		A _{rms}
Efficiency V _{IN} =24V _{dc} , T _A =25°C, I _O =I _{O,max}	All	η	-	84	—	%
Switching Frequency (Fixed) V _{IN} =9 to 36V _{dc} and I _O = I _{O,max}	All	f _{sw}	—	300	—	kHz
Dynamic Load Response ($\Delta I_O/\Delta t=0.1A/\mu s$, $V_{IN}=24 V_{dc}$, $T_A=25^\circ C$) Load Change from I _O = 50% to 75% or 25% to 50% of I _{O,max} : Peak Deviation Settling Time (V _O <10% peak deviation)	All All	V _{pk} t _s	— —	3.0 800	— —	%V _{O,set} μs

**Operation at 0A will not damage module

Isolation Specifications

Parameter	Symbol	Min	Typ	Max	Unit
Isolation Capacitance	C _{iso}	—	1000	—	pF
Isolation Resistance	R _{iso}	200	—	—	MΩ
I/O Isolation Voltage – (1minute at 1mA)	All		—	1600	Vdc

SHHN000A3 Series; DC-DC Converter Power Modules

9Vdc – 36Vdc input; +15V, -15V Dual Output, 0.3A 9W Output

General Specifications

Parameter		Min	Typ	Max	Unit
Calculated Reliability based upon Telcordia SR-332 Issue 2: Method I Case 3 ($V_{IN}=24V_{dc}$, $I_O=80\%I_{O,max}$, $T_A=40^\circ C$, airflow = 200 LFM, 90% confidence)	FIT		14.7		10^9 /Hours
	MTBF		68,221,069		Hours
Weight		—	8 (0.28)	—	g (oz.)

Feature Specifications

Unless otherwise indicated, specifications apply over all operating input voltage, resistive load, and temperature conditions. See Feature Descriptions for additional information.

Parameter	Device	Symbol	Min	Typ	Max	Unit
Remote On/Off Signal Interface ($V_{IN}=V_{IN,min}$ to $V_{IN,max}$; open collector or equivalent, Signal referenced to V_{IN} -terminal) Negative Logic: device code suffix "1" Logic Low = module On, Logic High = module Off Logic Low - Remote On/Off Current ($V_{on/off} = -0.7V_{dc}$) Logic Low - On/Off Voltage Logic High Voltage ($I_{on/off} = 0A_{dc}$) Logic High maximum allowable leakage current	All	$I_{on/off}$	—	—	0.15	mA
Logic Low - On/Off Voltage	All	$V_{on/off}$	-0.7	—	0.8	V_{dc}
Logic High Voltage ($I_{on/off} = 0A_{dc}$)	All	$V_{on/off}$	2.0	—	V_{IN}	V_{dc}
Logic High maximum allowable leakage current	All	$I_{on/off}$	—	—	25	μA
Positive Logic: No device code suffix required Logic Low = module Off, Logic High = module On Logic Low - Remote On/Off Current ($V_{on/off} = -0.7V_{dc}$) Logic Low - On/Off Voltage Logic High Voltage ($I_{on/off} = 0A_{dc}$) Logic High maximum allowable leakage current	All	$I_{on/off}$	—	—	0.15	mA
Logic Low - On/Off Voltage	All	$V_{on/off}$	-0.7	—	0.8	V_{dc}
Logic High Voltage ($I_{on/off} = 0A_{dc}$)	All	$V_{on/off}$	2.0	—	V_{IN}	V_{dc}
Logic High maximum allowable leakage current	All	$I_{on/off}$	—	—	25	μA
Turn-On Delay and Rise Times for each output ($I_O=80\%$ of $I_{O,max}$, $T_A=25^\circ C$) Case 1: Input power is applied for at least 1second, and then the On/Off input is set from OFF to ON ($T_{delay} =$ on/off pin transition until $V_O = 10\%$ of $V_{O,set}$) Case 2: On/Off input is set to Module ON, and then input power is applied ($T_{delay} = V_{IN}$ reaches $V_{IN,min}$ until $V_O = 10\%$ of $V_{O,set}$) Output voltage Rise time (time for V_O to rise from 10% of $V_{O,set}$ to 90% of $V_{O,set}$)	All	T_{delay} Case1	—	25		ms
	All	T_{delay} Case2	—	25		ms
	All	T_{rise}	—	25		ms
Output Voltage Overshoot ($I_O=80\%$ of $I_{O,max}$, $V_{IN}= 9$ to $36V_{dc}$, $T_A=25^\circ C$)					3	% $V_{O,set}$
Output Overvoltage Protection	All	$V_{O,limit}$		140		% $V_{O1,o2}$
Input Undervoltage Lockout Turn-on Threshold Turn-off Threshold Hysteresis	All	$V_{uv/on}$		8.5		V_{dc}
	All	$V_{uv/off}$		7.5		V_{dc}
	All	V_{hyst}		1.0		V_{dc}

SHHN000A3 Series; DC-DC Converter Power Modules

9Vdc – 36Vdc input; +15V, -15V Dual Output, 0.3A 9W Output

Characteristic Curves

The following figures provide typical characteristics for the SHHN000A3 (5V, 24A) at 25 °C. The figures are identical for either positive or negative remote On/Off logic.

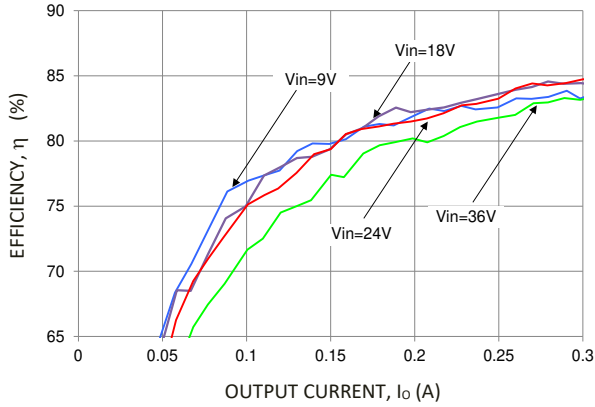

Figure 1. Converter Efficiency versus Output Current.

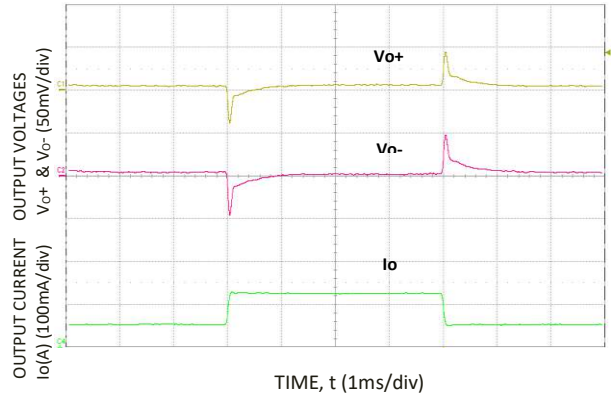

Figure 4. Transient Response to 0.1A/μS Dynamic Load Change from 50% to 75% to 50% of full load, Vin=24V.

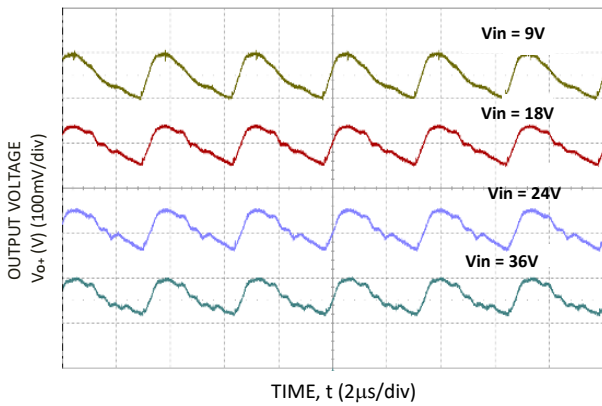

Figure 2. Typical output ripple and noise (V_{o+} , $I_o = I_{o,max}$).

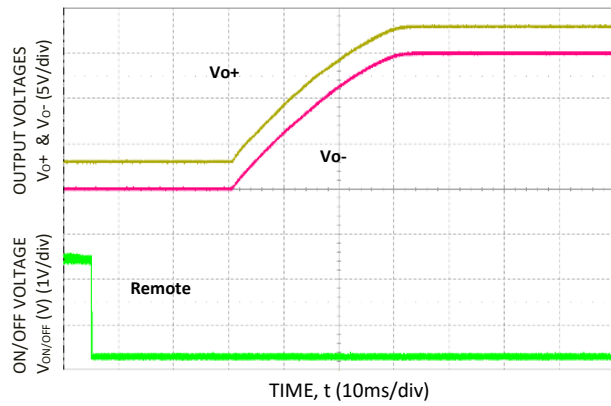

Figure 5. Typical Start-up Using Remote On/Off, negative logic version shown ($V_{IN} = 24V$, $I_o = I_{o,max}$).

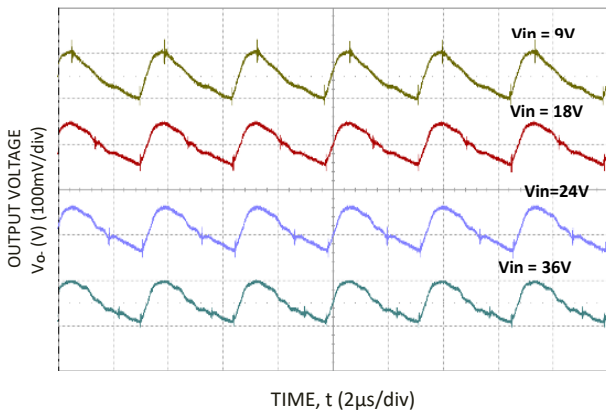

Figure 3. Typical output ripple and noise (V_{o-} , $I_o = I_{o,max}$).

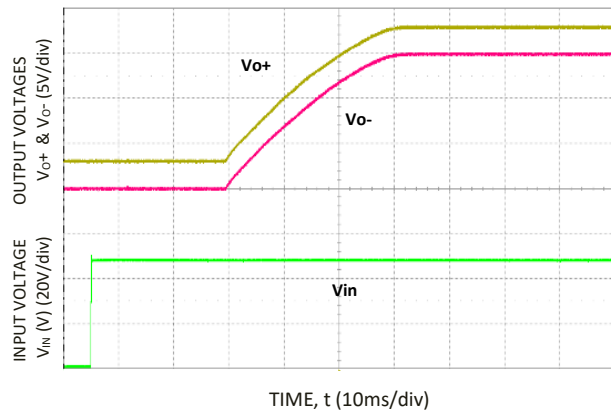

Figure 6. Typical Start-up Using Input Voltage ($V_{IN} = 24V$, $I_o = I_{o,max}$).

SHHN000A3 Series; DC-DC Converter Power Modules

9Vdc – 36Vdc input; +15V, -15V Dual Output, 0.3A 9W Output

Characteristic Curves (Continued)

The following figures provide typical characteristics for the SHHN000A3 (5V, 24A) at 25 °C. The figures are identical for either positive or negative remote On/Off logic

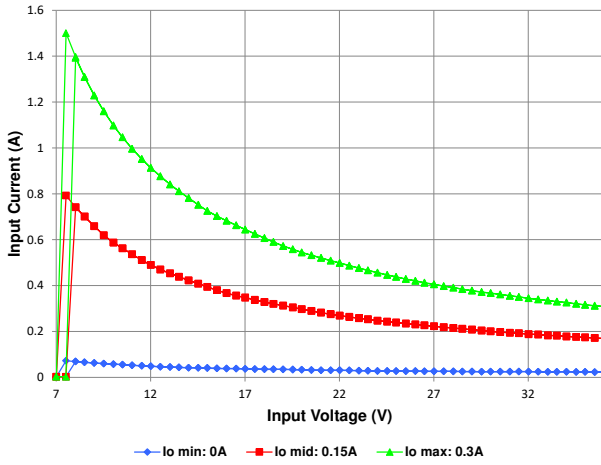
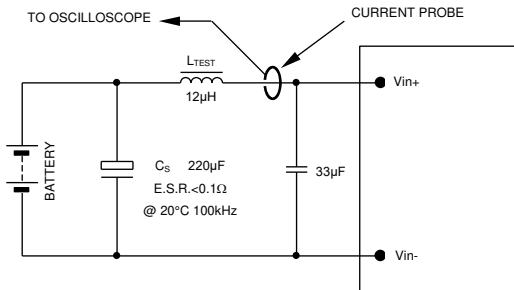

Figure 7. Input Current versus Input Voltage

SHHN000A3 Series; DC-DC Converter Power Modules

9Vdc – 36Vdc input; +15V, -15V Dual Output, 0.3A 9W Output

Test Configurations



NOTE: Measure input reflected ripple current with a simulated source inductance (L_{TEST}) of 12µH. Capacitor C_S offsets possible battery impedance. Measure current as shown above.

Figure 8. Input Reflected Ripple Current Test Setup.

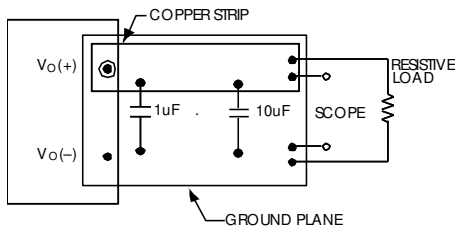

NOTE: All voltage measurements to be taken at the module terminals, as shown above. If sockets are used then Kelvin connections are required at the module terminals to avoid measurement errors due to socket contact resistance.

Figure 9. Output Ripple and Noise Test Setup.

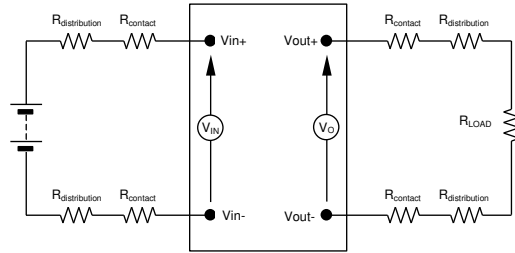

NOTE: All voltage measurements to be taken at the module terminals, as shown above. If sockets are used then Kelvin connections are required at the module terminals to avoid measurement errors due to socket contact resistance.

Figure 10. Output Voltage and Efficiency Test Setup.

$$\text{Efficiency } \eta = \frac{V_O \cdot I_O}{V_{IN} \cdot I_{IN}} \times 100 \%$$

Design Considerations

Input Source Impedance

The power module should be connected to a low ac-impedance source. Highly inductive source impedance can affect the stability of the power module. For the test configuration in Figure 8, a 33µF electrolytic capacitor (ESR<0.7Ω at 100kHz), mounted close to the power module helps ensure the stability of the unit

Safety Considerations

For safety-agency approval of the system in which the power module is used, the power module must be installed in compliance with the spacing and separation requirements of the end-use safety agency standard, i.e., UL 62368-1, CSA C22.2 No. 62368-1, and VDE 0868-1/A11 (IEC/EN62368, 2rd Edition).

The input to these units is to be provided with a maximum 3A fast-acting fuse in the ungrounded lead.

SHHN000A3 Series; DC-DC Converter Power Modules

9Vdc – 36Vdc input; +15V, -15V Dual Output, 0.3A 9W Output

Feature Description

Remote On/Off

Two remote on/off options are available. Positive logic turns the module on during a logic high voltage on the on/off pin, and off during a logic low. Negative logic remote on/off, device code suffix “1”, turns the module off during a logic high and on during a logic low.

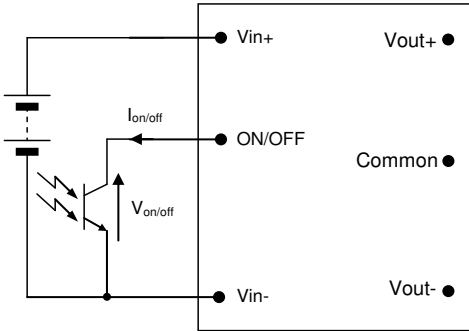

Figure 11. Circuit configuration for using Remote On/Off Implementation.

To turn the power module on and off, use a switch (open collector or equivalent) to control the voltage ($V_{on/off}$) between the ON/OFF terminal and the $V_{IN(-)}$ terminal. Logic low is $0V \leq V_{on/off} \leq 0.8V$. The maximum $I_{on/off}$ during a logic low is 0.15mA, the switch should maintain a logic low level whilst sinking this current.

During a logic high, the typical $V_{on/off}$ generated by the module is 2.4V, and the maximum allowable leakage current at $V_{on/off} = 2.4V$ is 25 μ A.

If not using the remote on/off feature is designed such that:

For positive logic, leave the ON/OFF pin open.

For negative logic, short the ON/OFF pin to $V_{IN(-)}$.

Overcurrent Protection

To provide protection in a fault (output overload) condition, the unit is equipped with internal current-limiting circuitry and can endure current limiting continuously. At the point of current-limit

inception, the unit shall enter hiccup mode. The unit shall operate normally once the output current is brought back into its specified range. The average output current during hiccup is 10% $I_{O, max}$.

Overtemperature Protection

To provide protection under certain fault conditions, the unit is equipped with a thermal shutdown circuit. The unit shall shutdown if the thermal reference point T_{ref} (Figure 13), exceeds 110°C. The module shall automatically restart upon cool-down to a safe temperature.

Input Undervoltage Lockout

At input voltages below the input undervoltage lockout limit, the module operation is disabled. The module will only begin to operate once the input voltage is raised above the undervoltage lockout turn-on threshold, $V_{UV/ON}$. Once operating, the module continues to operate until the input voltage is taken below the undervoltage turn-off threshold, $V_{UV/OFF}$.

Over Voltage Protection

The output overvoltage protection consists of circuitry that independently monitors the output voltage, and shuts the module down if the output voltage exceeds specified limits. The module contains hiccup restart capability.

SHHN000A3 Series; DC-DC Converter Power Modules

9Vdc – 36Vdc input; +15V, -15V Dual Output, 0.3A 9W Output

Thermal Considerations

The power module is capable of operating in a variety of thermal environments.

The thermal data has been gathered based on physical measurements taken in a wind tunnel, using automated thermo-couple instrumentation to monitor key component temperatures: FETs, diodes, control ICs, magnetic cores, ceramic capacitors, opto-isolators, and module pwb conductors, while controlling the ambient airflow rate and temperature. For a given airflow and ambient temperature, the module output power is increased, until one (or more) of the components reaches its maximum derated operating temperature, as defined in IPC-9592A. This procedure is then repeated for a different airflow or ambient temperature until a family of module output derating curves is obtained.

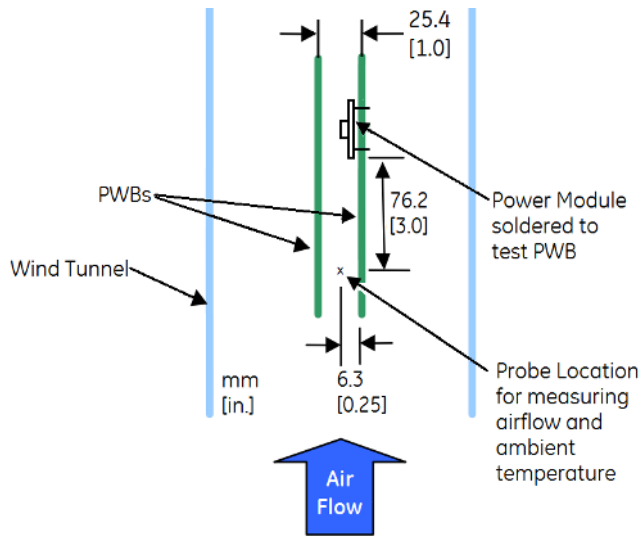

Figure 12. Thermal Test Setup .

The thermal reference point, T_{ref} used in the specifications is defined based on actual data. For reliable operation this temperature should not exceed 110°C

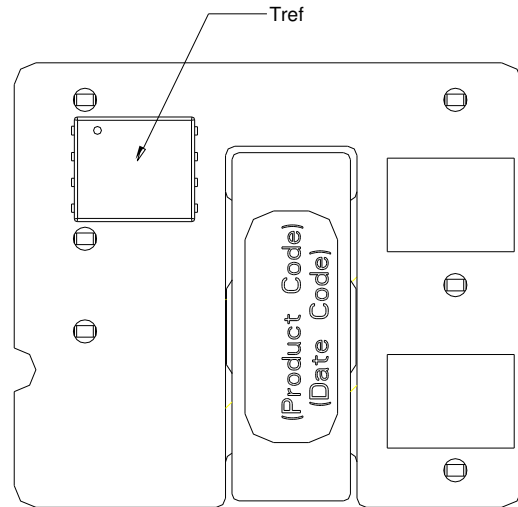

Figure 13. T_{ref} Temperature Measurement Location.

Heat Transfer via Convection

Increased airflow over the module enhances the heat transfer via convection. Derating curves showing the maximum output current that can be delivered by each module versus local ambient temperature (T_A) for natural convection are shown in Figures 14 - 15.

Please refer to the Application Note “Thermal Characterization Process For Open-Frame Board-Mounted Power Modules” for a detailed discussion of thermal aspects including maximum device temperatures.

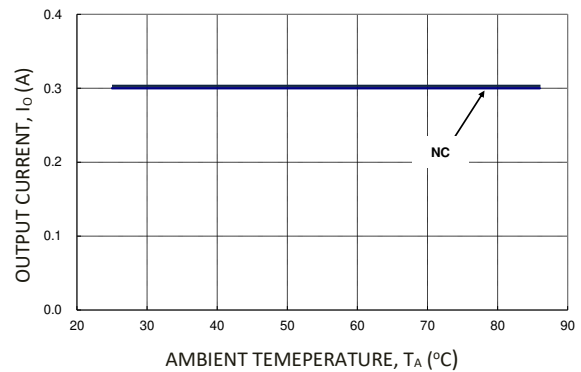

Figure 14. Output Current Derating for the Open Frame Module; Airflow in the Transverse Direction from $V_{out(-)}$ to $V_{out(+)}$; $V_{IN} = 18V$, $V_O = +15V, -15V$

SHHN000A3 Series; DC-DC Converter Power Modules

9Vdc – 36Vdc input; +15V, -15V Dual Output, 0.3A 9W Output

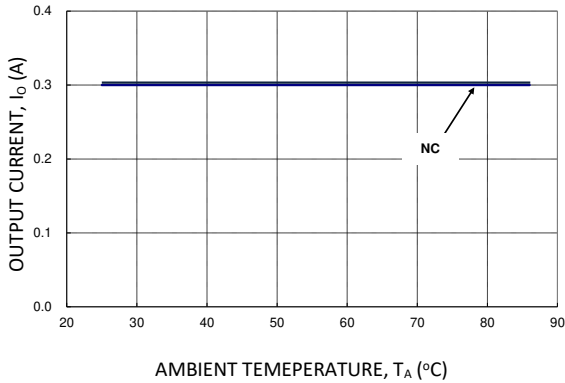
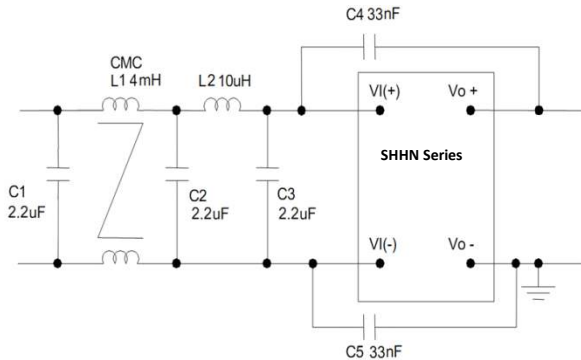

Figure 15. Output Current Derating for the Module with Heatplate; Airflow in the Transverse Direction from $V_{out(-)}$ to $V_{out(+)}$; $V_{IN}=24V$, $V_O=+15V$, $-15V$

EMC Requirements

The design of the module shall include an external filter configuration to meet the conducted emission limits of EN55032 Class B. However, an onboard inductor is provided in the module to meet Class B with modest external filtering



Ref Des	Filter
C1 , C2, C3	2.2uF/100V
C4, C5	33nF Y Cap
L1	4mH CM choke
L2	10uH inductor

Figure 16. Suggested Configuration for EN55032 Class B.

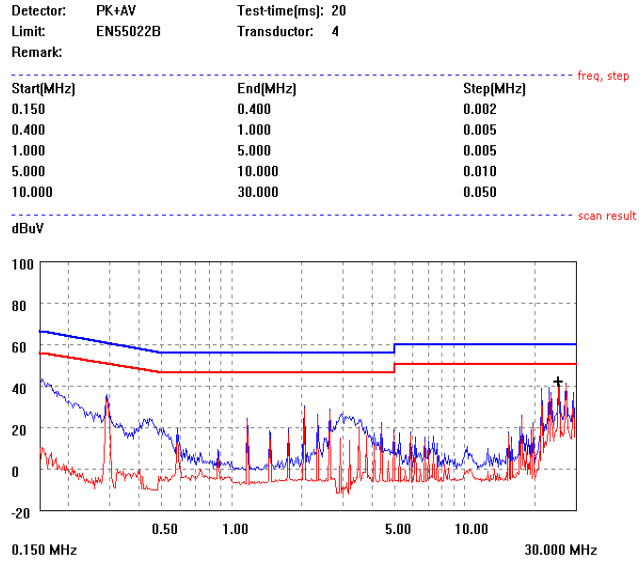

Figure 17. SHHN000A3 V_{in+} Line EMC signature using above filter, $V_{in}=24V$, Blue=PK, Red=Avg.

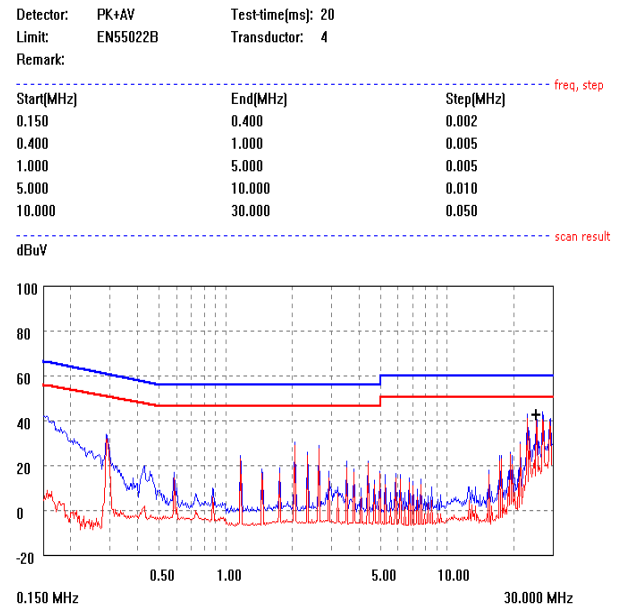

Figure 18. SHHN000A3 V_{in} Neutral EMC signature using above filter, $V_{in}=24V$, Blue=PK, Red=Avg.

SHHN000A3 Series; DC-DC Converter Power Modules

9Vdc – 36Vdc input; +15V, -15V Dual Output, 0.3A 9W Output

Layout Considerations

The SHHN000A3 power module series are low profile in order to be used in fine pitch system card architectures. As such, component clearance between the bottom of the power module and the mounting board is limited. Avoid placing copper areas on the outer layer directly underneath the power module. Also avoid placing via interconnects underneath the power module.

The SHHN000A3 family of power modules is available for either Through-Hole (TH) or Surface Mount (SMT) soldering.

Through-Hole Soldering Information

The RoHS-compliant (Z codes) through-hole products use the SAC (Sn/Ag/Cu) Pb-free solder and RoHS-compliant components. They are designed to be processed through single or dual wave soldering machines. The pins have an RoHS-compliant finish that is compatible with both Pb and Pb-free wave soldering processes. A maximum preheat rate of 3°C/s is suggested. The wave preheat process should be such that the temperature of the power module board is kept below 210°C. For Pb solder, the recommended pot temperature is 260°C, while the Pb-free solder pot is 270°C max. The Through Hole module is also compatible with paste-in-hole reflow soldering. Refer to the Reflow Soldering Information section for process details. If additional information is needed, please consult with your GE representative for more details.

Surface Mount Information

Pick and Place

The SHHN-SR series of DC-to-DC power converters use an open-frame construction and are designed for surface mount assembly within a fully automated manufacturing process.

The SHHN-SR series modules are designed to use the main magnetic component surface to allow for pick and place.

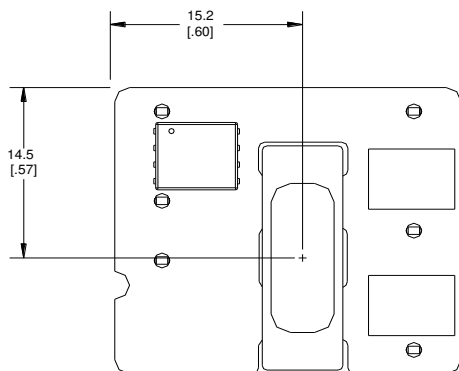

Note: All dimensions in mm [in].

Figure 19. Pick and Place Location.

Z Plane Height

The 'Z' plane height of the pick and place location is 7.50mm nominal with an RSS tolerance of +/-0.25 mm.

Nozzle Recommendations

The module weight has been kept to a minimum by using open frame construction. Even so, they have a relatively large mass when compared with conventional SMT components. Variables such as nozzle size, tip style, vacuum pressure and placement speed should be considered to optimize this process.

The minimum recommended nozzle diameter for reliable operation is 5mm. The maximum nozzle outer diameter, which will safely fit within the allowable component spacing, is 6.5mm.

Oblong or oval nozzles up to 11 x 6 mm may also be used within the space available.

For further information please contact your local GE Technical Sales Representative.

Reflow Soldering Information

These power modules are large mass, low thermal resistance devices and typically heat up slower than other SMT components. It is recommended that the customer review data sheets in order to customize the solder reflow profile for each application board assembly.

The following instructions must be observed when SMT soldering these units. Failure to observe these instructions may result in the failure of or cause damage to the modules, and can adversely affect long-term reliability.

There are several types of SMT reflow technologies currently used in the industry. These surface mount power modules can be reliably soldered using natural forced convection, IR (radiant infrared), or a combination of convection/IR. The recommended linear reflow profile using Sn/Pb solder is shown in Figure 19 and 20. For reliable soldering the solder reflow profile should be established by accurately measuring the module's pin connector temperatures.

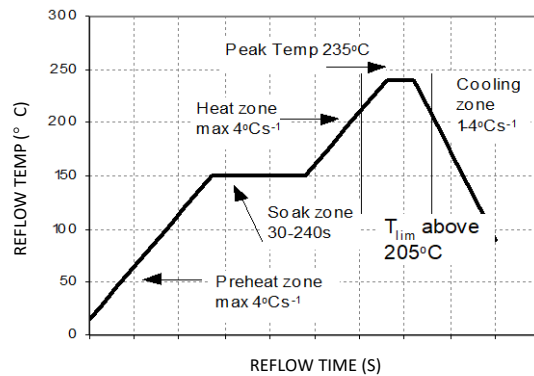

Figure 20. Recommended Reflow Profile for Sn/Pb solder.

SHHN000A3 Series; DC-DC Converter Power Modules

9Vdc – 36Vdc input; +15V, -15V Dual Output, 0.3A 9W Output

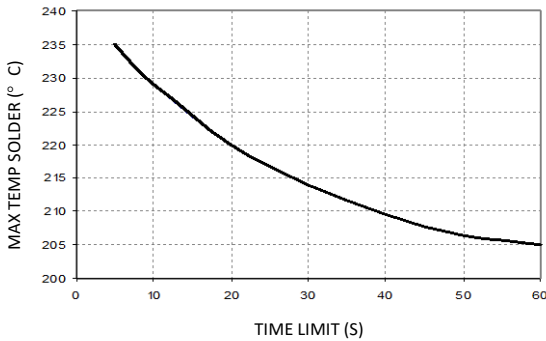

Figure 21. Time Limit, T_{lim}, Curve Above 205°C Reflow .

Lead Free Soldering

The -Z version SMT modules of the SHHN000A3 series are lead-free (Pb-free) and RoHS compliant and are compatible in a Pb-free soldering process. Failure to observe the instructions below may result in the failure of or cause damage to the modules and can adversely affect long-term reliability.

Pb-free Reflow Profile

Power Systems will comply with J-STD-020 Rev. D (Moisture/Reflow Sensitivity Classification for Nonhermetic Solid State Surface Mount Devices)

for both Pb-free solder profiles and MSL classification procedures. This standard provides a recommended forced-air-convection reflow profile based on the volume and thickness of the package (table 4-2). The suggested Pb-free solder paste is Sn/Ag/Cu (SAC). The recommended linear reflow profile using Sn/Ag/Cu solder is shown in Figure 22.

Surface Mount Information (continued)

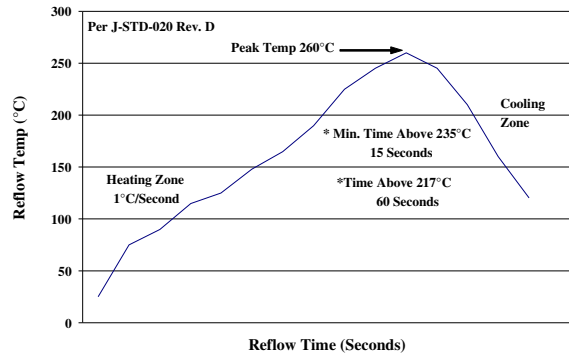

Figure 22. Recommended linear reflow profile using Sn/Ag/Cu solder.

MSL Rating

The SHHN000A3 series modules have a MSL rating of 3.

Storage and Handling

The recommended storage environment and handling procedures for moisture-sensitive surface mount packages is detailed in J-STD-033 Rev. A (Handling, Packing, Shipping and Use of Moisture/Reflow Sensitive Surface Mount Devices). Moisture barrier bags (MBB) with desiccant are required for MSL ratings of 2 or greater. These sealed packages should not be broken until time of use. Once the original package is broken, the floor life of the product at conditions of ≤ 30°C and 60% relative humidity varies according to the MSL rating (see J-STD-033A). The shelf life for dry packed SMT packages will be a minimum of 12 months from the bag seal date, when stored at the following conditions: < 40° C, < 90% relative humidity.

Post Solder Cleaning and Drying Considerations

Post solder cleaning is usually the final circuit-board assembly process prior to electrical board testing. The result of inadequate cleaning and drying can affect both the reliability of a power module and the testability of the finished circuit-board assembly. For guidance on appropriate soldering, cleaning and drying procedures, refer to GE *Board Mounted Power Modules: Soldering and Cleaning* Application Note (AP01-056EPS).

SHHN000A3 Series; DC-DC Converter Power Modules

9Vdc – 36Vdc input; +15V, -15V Dual Output, 0.3A 9W Output

Mechanical Outline for Through-Hole Module

Dimensions are in millimeters and [inches].

Tolerances: x.x mm ± 0.5 mm [x.xx in. ± 0.02 in.] (Unless otherwise indicated)

x.xx mm ± 0.25 mm [x.xxx in ± 0.010 in.]

*Top side label includes GE name, product designation and date code.

Top View

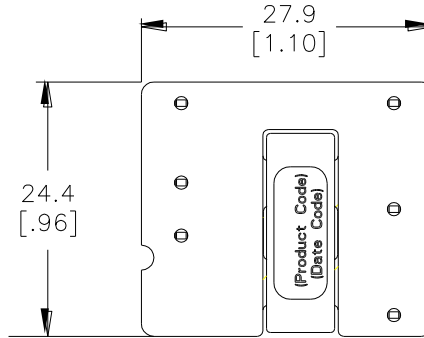

Side View

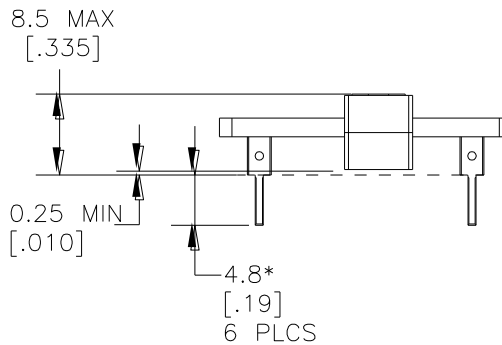

*For optional pin lengths, see Table 2, Device Options

Bottom View

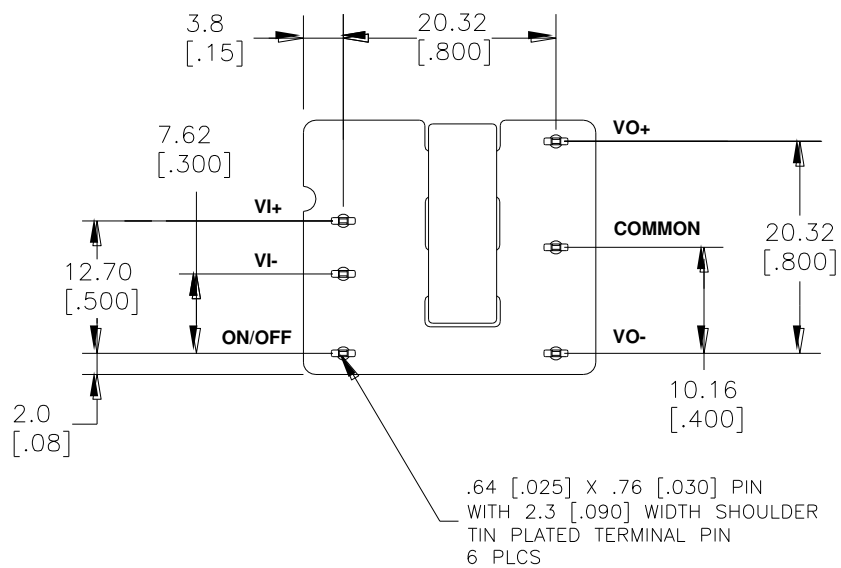

SHHN000A3 Series; DC-DC Converter Power Modules

9Vdc – 36Vdc input; +15V, -15V Dual Output, 0.3A 9W Output

Mechanical Outline for SMT version

Dimensions are in millimeters and [inches].

Tolerances: x.x mm ± 0.5 mm [x.xx in. ± 0.02 in.] (Unless otherwise indicated)

x.xx mm ± 0.25 mm [x.xxx in ± 0.010 in.]

*Top side label includes GE name, product designation and date code.

Top View

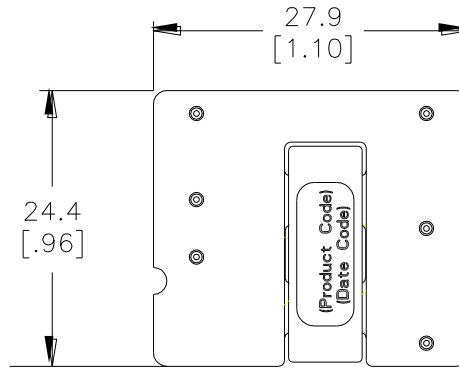

Side View

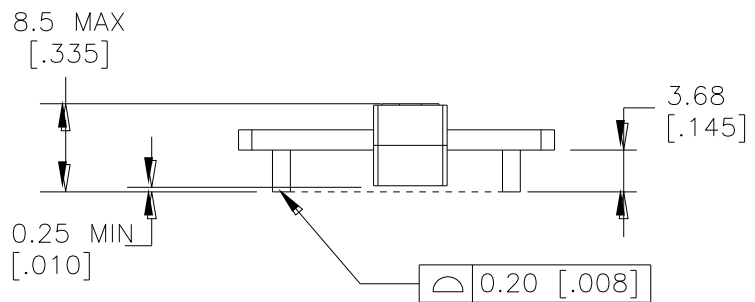

Bottom View

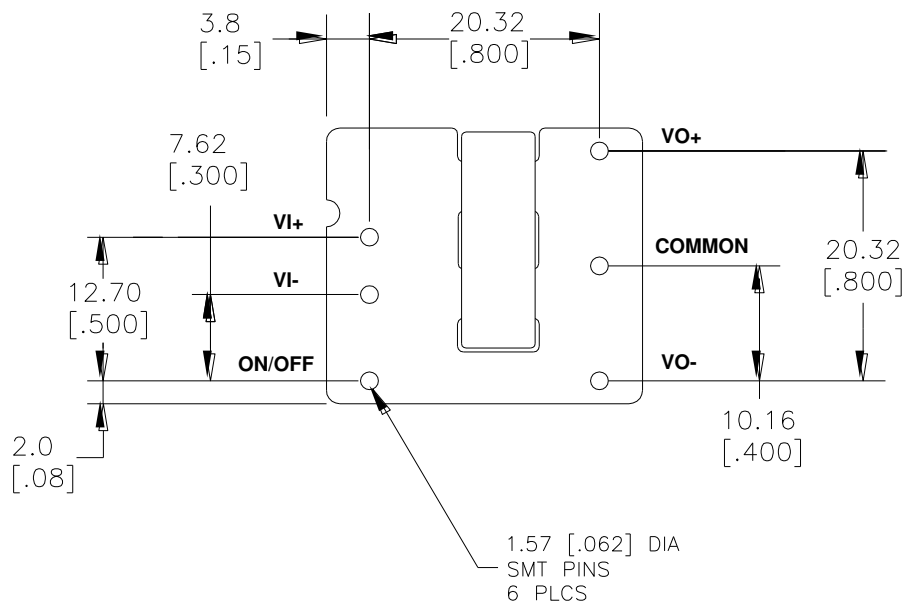

SHHN000A3 Series; DC-DC Converter Power Modules

9Vdc – 36Vdc input; +15V, -15V Dual Output, 0.3A 9W Output

Recommended Pad Layout

Dimensions are in millimeters and [inches].

Tolerances: x.x mm ± 0.5 mm [x.xx in. ± 0.02 in.] (Unless otherwise indicated)

x.xx mm ± 0.25 mm [x.xxx in ± 0.010 in.]

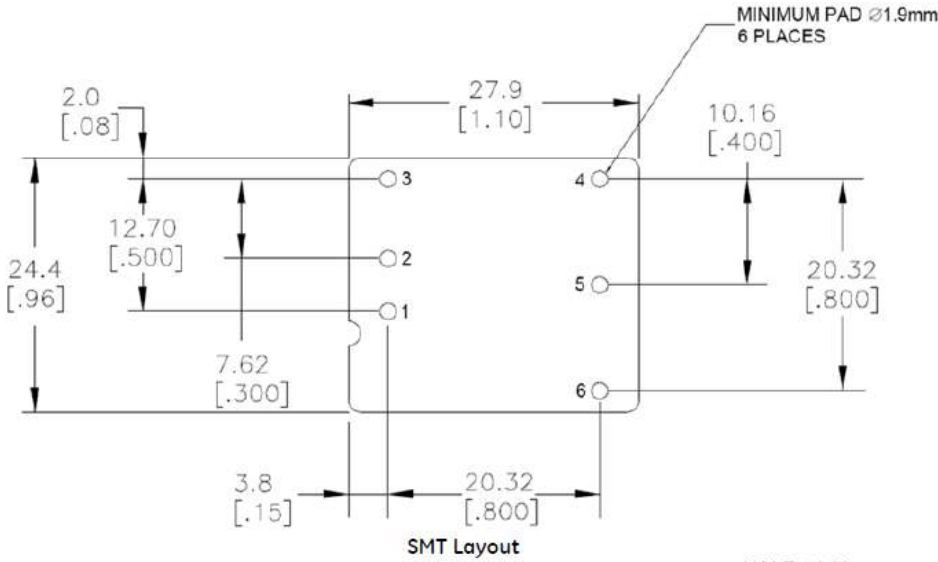

Pin	Function
1	Vin+
2	Vin-
3	On/Off
4	Vout-
5	Common
6	Vout+

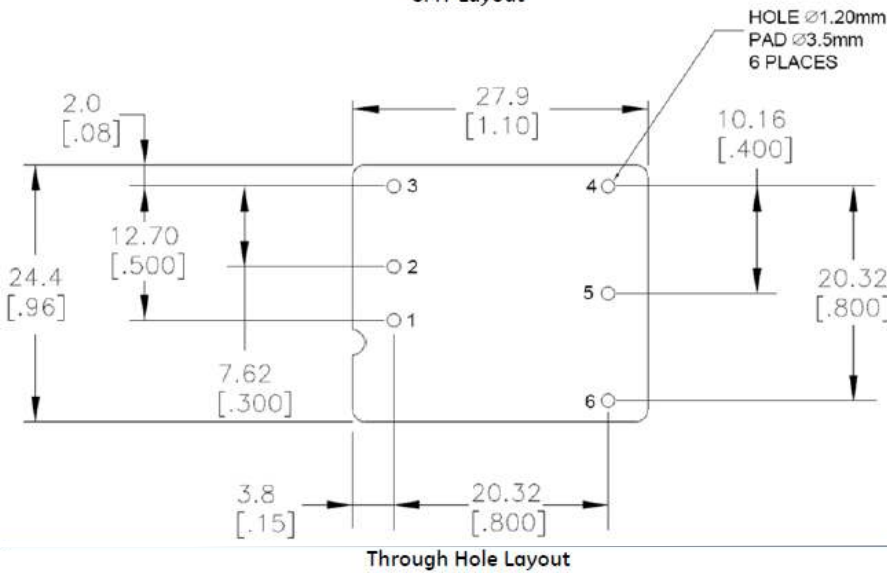

SHHN000A3 Series; DC-DC Converter Power Modules

9Vdc – 36Vdc input; +15V, -15V Dual Output, 0.3A 9W Output

Packaging Details

The SHHN000A3 series SMT versions are supplied in tape & reel as standard. Details of tape dimensions are shown below. Modules are shipped in quantities of 150 modules per reel.

Tape Dimensions

Dimensions are in millimeters and [inches].

Tolerances: x.x mm ± 0.5 mm [x.xx in. ± 0.02 in.] (unless otherwise indicated)

x.xx mm ± 0.25 mm [x.xxx in ± 0.010 in.]

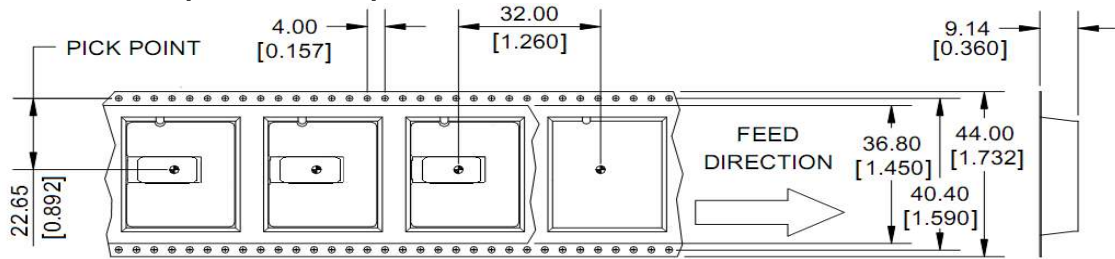

Reel Dimensions

Outside Diameter: 330.2 mm [13.00"]

Inside Diameter: 177.8 mm [7.00"]

Tape Width: 44.00 [1.732]

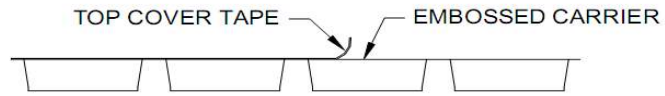

NOTE: CONFORMS TO EAI-481 REV. A STANDARD

The SHHN000A3 series Through Hole versions are supplied in trays as standard. Details of tray dimensions are shown below. Modules are shipped in quantities of 75 modules per box.

SHHN000A3 Series; DC-DC Converter Power Modules

9Vdc – 36Vdc input; +15V, -15V Dual Output, 0.3A 9W Output

Tray Dimensions

The SHHN000A3 - series Through Hole versions are supplied in trays as standard. Details of tray dimensions are shown below. Modules are shipped in quantities of 75 modules per box. Dimensions are in millimeters.

Tolerances: x.x mm ± 0.5 mm (unless otherwise indicated)

x.xx mm ± 0.25 mm



Material	PET (1mm)
Max surface resistivity	10 ⁹ -10 ¹¹ Ω/PET
Color	Clear
Capacity	25power modules
Min order quantity	75pcs (1 box of 3 full trays + 1 empty top tray)

SHHN000A3 Series; DC-DC Converter Power Modules

9Vdc – 36Vdc input; +15V, -15V Dual Output, 0.3A 9W Output

Ordering Information

Please contact your GE Sales Representative for pricing, availability and optional features.

Table 1. Device Codes

Device Code	Input Voltage Range	Output Voltage	Output Current	On/Off Logic	Surface Mount	Comcodes
SHHN000A3CL41-SRZ	9 – 36Vdc	+15V, -15V	0.3A	Negative	Yes	150031671
SHHN000A3CL4-SRZ	9 – 36Vdc	+15V, -15V	0.3A	Positive	Yes	150031675
SHHN000A3CL41Z	9 – 36Vdc	+15V, -15V	0.3A	Negative	No	150031070
SHHN000A3CL4Z	9 – 36Vdc	+15V, -15V	0.3A	Positive	No	150031672

-Z refers to RoHS compliant parts

Table 2. Device Options

	Characteristic	Character and Position	Definition	
Ratings	Form Factor	S	S = 1 x 1 Brick	
	Family Designator	HH	HH = Hammerhead* Series	
	Input Voltage	N	N = Wide Range, 9V-36V	
	Output Current	000A3	000A3 = 000.3 Amps Maximum Output Current	
	Output Voltage	CL	C = +15Volts, L = -15Volts	
Options	Pin Length	6 8	Omit = Default Pin Length shown in Mechanical Outline Figures 6 = Pin Length: 3.68 mm ± 0.25mm , (0.145 in. ± 0.010 in.) 8 = Pin Length: 2.79 mm ± 0.25mm , (0.110 in. ± 0.010 in.)	
	Action following Protective Shutdown	4	4 = Auto-restart following shutdown (Overcurrent/Overvoltage) Must be ordered	
	On/Off Logic	1	Omit = Positive Logic 1 = Negative Logic	
	Customer Specific	XY	XY = Customer Specific Modified Code, Omit for Standard Code	
	Mechanical Features		SF	Omit = Standard open Frame Module S = Surface Mount connections: R = Tape & Peel Packaging
		RoHS	Z	Omit = RoHS 5/6, Lead Based Solder Used Z = RoHS 6/6 Compliant, Lead free

Contact Us

For more information, call us at

USA/Canada:

+1 888 546 3243, or +1 972 244 9288

Asia-Pacific:

+86-21-53899666

Europe, Middle-East and Africa:

+49.89.878067-280

Go.ABB/Industrial



GE Critical Power reserves the right to make changes to the product(s) or information contained herein without notice, and no liability is assumed as a result of their use or application. No rights under any patent accompany the sale of any such product(s) or information.