

● Features:

1. Emitted Color : Green
2. Lens Appearance : Water Clear
3. Mono-color type.
4. 1.7x0.6x1.1mm standard package
5. Suitable for all SMT assembly methods.
6. Compatible with infrared and vapor phase reflow solder process.
7. Compatible with automatic placement equipment.
8. This product doesn't contain restriction Substance, comply ROHS standard.

● Applications:

1. Backlighting : LCDs, Key pads advertising.
2. Status indicators : Consumer & industrial electronics.
3. General use.

● Package Dimensions:

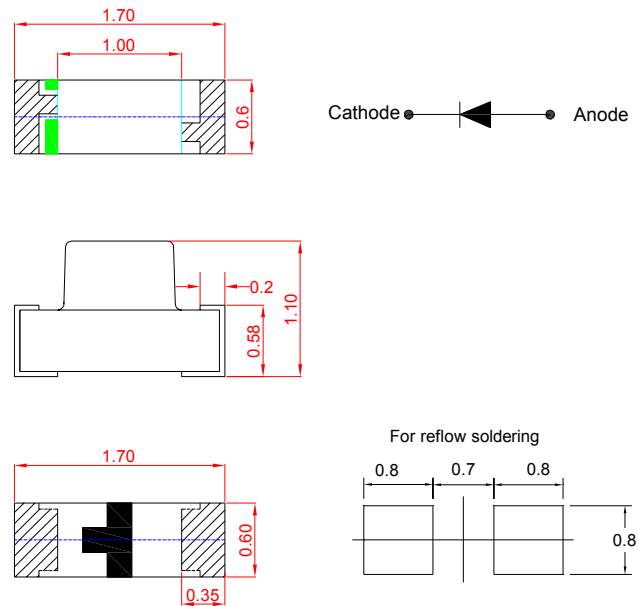

NOTES:

1. All dimensions are in millimeters
2. Tolerance is ± 0.10 mm unless otherwise specified.
3. Specifications are subject to change without notice.

● Absolute Maximum Ratings(Ta=25°C)

Parameter	Symbol	Rating	Unit
Power Dissipation	Pd	70	mW
Forward Current	I _F	20	mA
Peak Forward Current * 1	I _{FP}	100	mA
Reverse Voltage	V _R	5	V
Operating Temperature	Topr	-40°C ~85°C	-
Storage Temperature	Tstg	-40°C ~85°C	-
Soldering Temperature	Tsol	See Page6	-

* 1 Condition for I_{FP} is pulse of 1/10 duty and 0.1msec width.



● Electrical and optical characteristics(Ta=25°C)

Parameter	Symbol	Condition	Min.	Typ.	Max.	Unit
Forward Voltage	V _f	I _f =5mA	-	2.8	3.2	V
Luminous Intensity	I _v	I _f =5mA	94	210	-	mcd
Reverse Current	I _R	V _R =5V	-	-	1	μA
Peak Wave Length	λ _p	I _f =5mA	-	520	-	nm
Dominant Wave Length	λ _d	I _f =5mA	520	-	535	nm
Spectral Line Half-width	Δλ	I _f =5mA	-	30	-	nm
Viewing Angle	2θ _{1/2}	I _f =5mA	-	120	-	deg

● Typical Electro-Optical Characteristics Curves

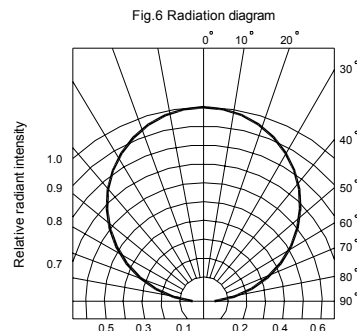
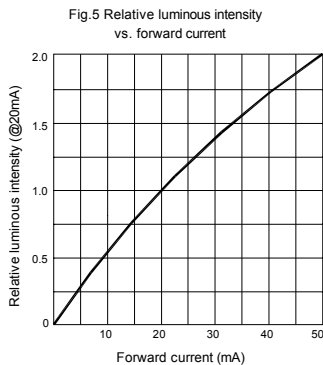
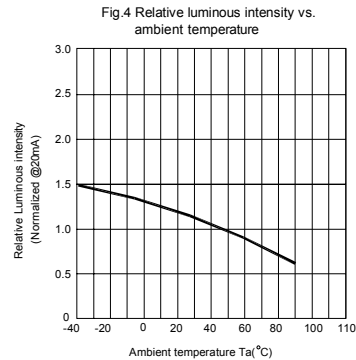
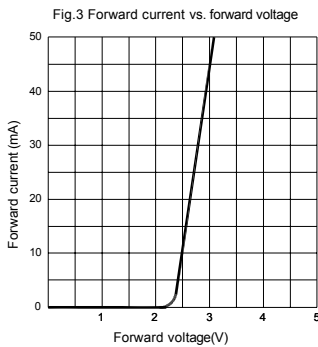
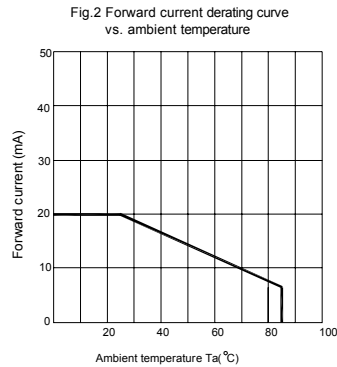
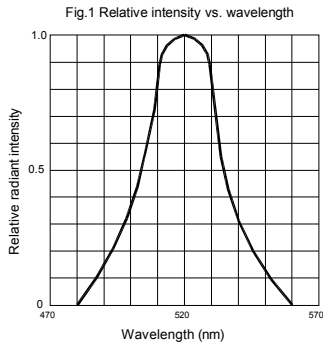

● Tapping and packaging specifications(Units: mm)

Quantity:4000PCS

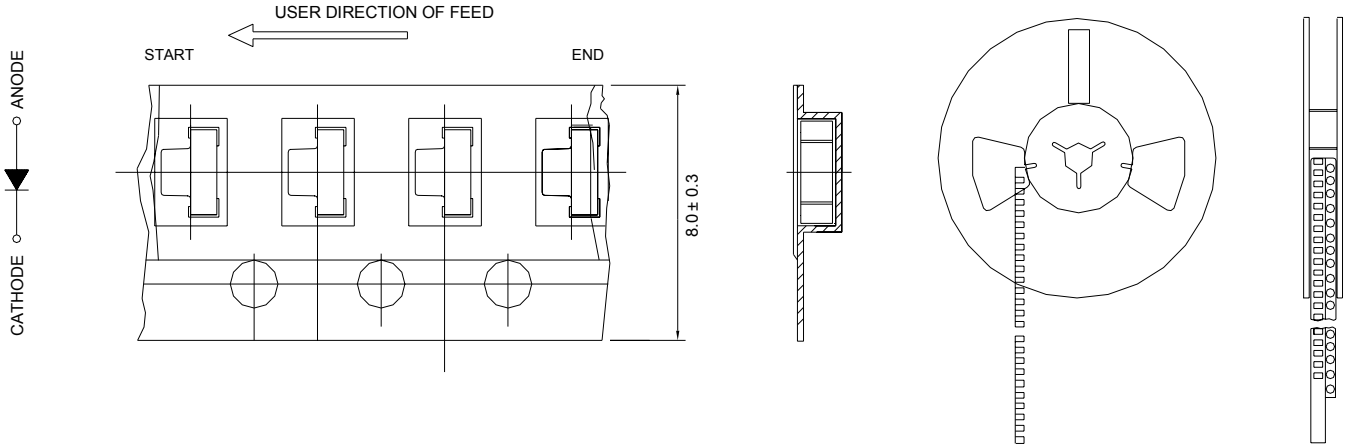

● Package Method:(unit:mm) Vacuum

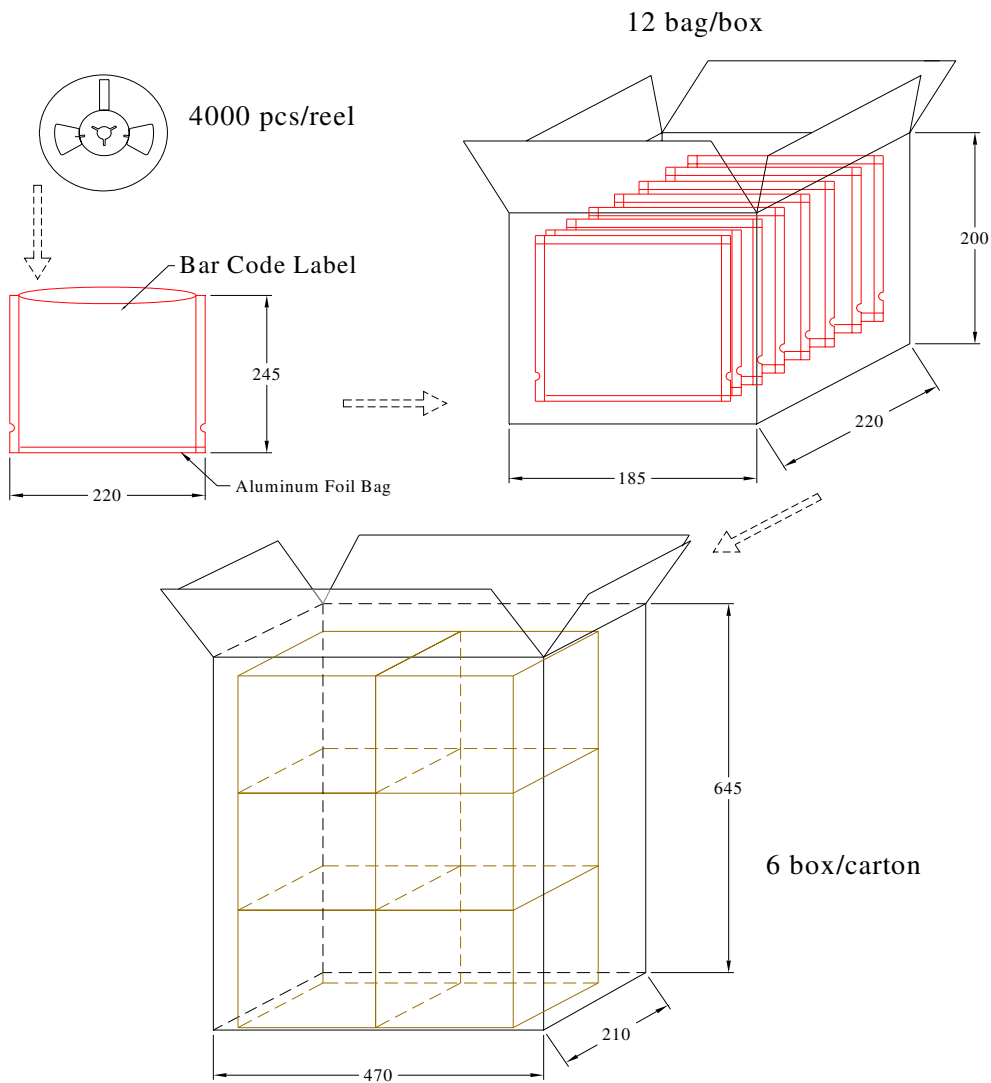



● **Bin Limits**

Intensity Bin Limits (At 5mA)

BIN CODE	Min. (mcd)	Max. (mcd)
Q	94	140
R	140	210
S	210	317
T	317	475

Tolerance for each Bin limit is $\pm 15\%$

Color Bin Limits (At 5mA)

BIN CODE	Min. (nm)	Max. (nm)
6	520	525
7	525	530
8	530	535

Tolerance for each Bin limit is $\pm 1\text{nm}$

V_F Bin Limits (At 5mA)

BIN CODE	Min.(v)	Max.(v)
E	2.4	2.6
F	2.6	2.8
G	2.8	3.0
H	3.0	3.2

Tolerance for each Bin limit is ± 0.05

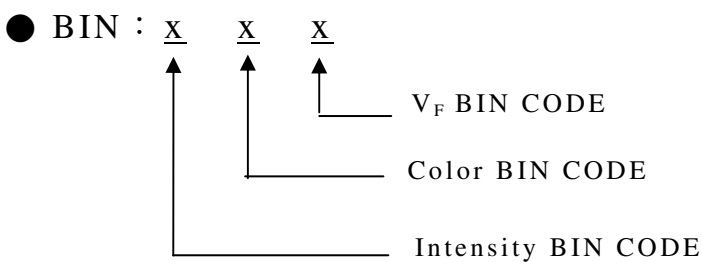



● Reliability Test

Classification	Test Item	Reference Standard	Test Conditions	Result
Endurance Test	Operation Life	MIL-STD-750D:1026 MIL-STD-883D:1005 JIS-C-7021 :B-1	Ta: Under room temperature Test time:1,000hrs IF=Product Recommended IF	0/32
	High Temperature High Humidity Storage	MIL-STD-202F:103B JIS-C-7021 :B-11	Ta:85±5°C RH:90%-95% Test time:240hrs	0/32
	High Temperature Storage	MIL-STD-883:1008 JIS-C-7021 :B-10	Ta:100±5°C Test time:1,000hrs	0/32
	Low Temperature Storage	JIS-C-7021 :B-11	Ta: -40±5°C Test time=1,000hrs	0/32
Environmental Test	Temperature Cycling	MIL-STD-202F:107D MIL-STD-750D:1051 MIL-STD-883D:1010 JIS-C-7021 :A-2	Ta:-35±5°C~25±5°C~85±5°C~25±5°C 30min 5min 30min 5min	0/32
	Thermal Shock	MIL-STD-202F:107D(1980) MIL-STD-750D:1051(95) MIL-STD-883D:1011(1991)	Ta:-40±5°C ~+85±5°C 10min 10 min Time: 20min/cycle 10cycle	0/32
	Wetting balance	MIL-STD-883:2003 MIL-STD-202F:208D MIL-STD-883D:2003	Ta:230±5°C Time:5±0.5s	0/32
	Solder Resistance	MIL-STD-202F:210A MIL-STD-883D:1011 JIS-C-7021 :A-1	Ta:260±10°C Time:10±1s	0/32

● Judgment criteria of failure for the reliability

Measuring items	Symbol	Measuring conditions	Judgement criteria for failure
Forward voltage	V_F (V)	$I_F=5mA$	Initial Level*1.1
Reverse current	$I_R(uA)$	$V_R=5V$	Over U*2
Luminous intensity	I_v (mcd)	$I_F=5mA$	Initial Level*0.7

Note: 1.U means the upper limit of specified characteristics.

2.Measurment shall be taken between 2 hours and after the test pieces have been returned to normal ambient conditions after completion of each test.

● IR-Reflow Soldering

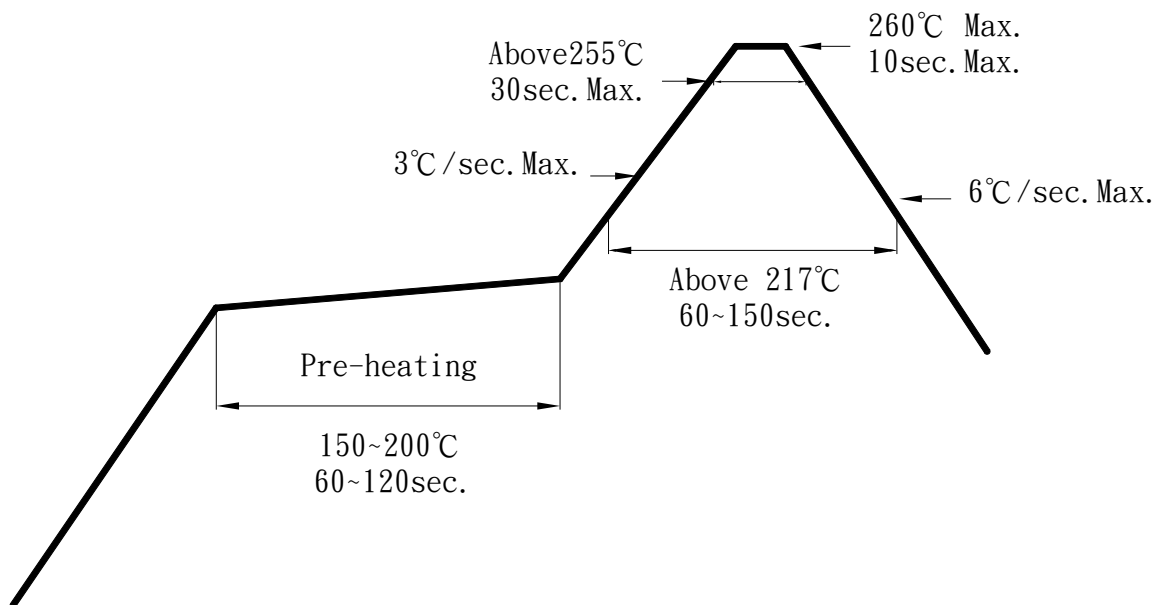

1. Avoid any external stress applied to the resin while the LEDs are at high temperature, especially during soldering .
2. Avoid rapid cooling or any excess vibration during temperature ramp-down process
3. Although the soldering condition is recommended above, soldering at the lowest possible temperature is feasible for the LEDs

● IRON Soldering

350°C Within 3 sec., One time only.



● Notes for designing:

Care must be taken to provide the current limiting resistor in the circuit so as to drive the BRIGHT LEDs within the rated figures. Also, caution should be taken not to overload BRIGHT LEDs with instantaneous voltage at the turning ON and OFF of the circuit.

When using the pulse drive care must be taken to keep the average current within the rated figures. Also, the circuit should be designed so as to be subjected to reverse voltage when turning off the BRIGHT LEDs.

● Storage:

In order to avoid the absorption of moisture, it is recommended to solder BRIGHT LEDs as soon as possible after unpacking the sealed envelope.

If the envelope is still packed, to store it in the environment as following:

- (1) Temperature : 5°C -30°C (41°F) Humidity : RH 60% Max.
- (2) After this bag is opened, devices that will be applied to infrared reflow, vapor-phase reflow, or equivalent soldering process must be:
 - a. Completed within 168 hours.
 - b. Stored at less than 30% RH.
- (3) Devices require baking before mounting, if:
 - (2) a or (2) b is not met.
- (4) If baking is required, devices must be baked under below conditions:
48 hours at 60°C±3°C.

● Package and Label of Products:

- (1) Package: Products are packed in one bag of 4000 pcs (one taping reel) and a label is attached on each bag.
- (2) Label:

