

AEDR-8400 Series

Reflective Surface Mount Optical Encoder

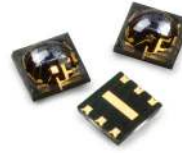

Data Sheet



Description

The AEDR-8400 encoder is the smallest optical encoder employing reflective technology for motion control purposes. The encoder houses an LED light source and a photo-detecting circuitry in a single package.

The AEDR-8400 encoder offers two-channel quadrature digital outputs. Being TTL compatible, the outputs of the AEDR-8400 encoder can be interfaced directly with most of the signal processing circuitries. Hence the encoder provides great design-in flexibility and easy integration into existing systems.

Features

- Reflective technology
- Surface mount leadless package
- Two channel quadrature digital outputs for direction sensing
- TTL compatible
- Single 2.8V supply
- -20°C to 85°C absolute operating temperature
- Encoding resolution:
 - 254 (lines/inch) or 10 (lines/mm)
 - 318 (lines/inch) or 12.5 (lines/mm)

Applications

Ideal for high volume applications:

- Printers
- Copiers
- Card readers
- Scanners
- Digital Still Cameras
- Camcorders
- Camera Phones
- Projectors
- Consumer Product Applications

Note: Avago Technologies encoders are not recommended for use in safety critical applications such as. ABS braking systems, power steering, life support systems and critical care medical equipment. Please contact our sales representative if clarification is needed.

Theory of Operation

The AEDR-8400 encoder combines an emitter and a detector in a single surface mount leadless package. When used with a codewheel or linear codestrip, the encoder translates rotary or linear motion into digital outputs. As seen in the block diagram, the AEDR-8400 consists of three major components: a light emitting diode (LED) light source, a detector IC consisting photodiodes and lens to focus light beam from the emitter as well as light falling on the detector.

Block Diagram of AEDR-8400 Encoder

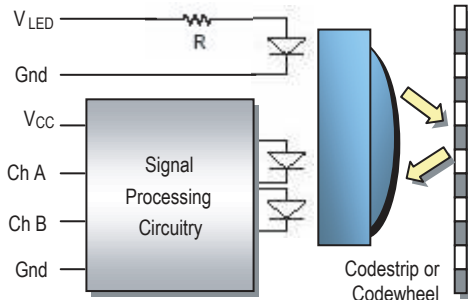

Note: Drawing not to scale.

The operation of the encoder is based on the principle of optics where the detector photodiodes sense the absence and presence of light. In this case, the rotary/linear motion of an object being monitored is converted to equivalent light pattern via the use of codewheel/codestrip. As shown in the above diagram, the reflective area (window) of the codewheel (or codestrip) reflects light back to the photodetector IC, whereas no light is reflected by the non-reflective area (bar). An alternating light and dark patterns corresponding to the window and bar fall on the photodiodes as the codewheel rotates. The moving light pattern is exploited by the detector circuitry to produce digital outputs representing the rotation of the codewheel. When the codewheel is coupled to a motor, the encoder outputs are then a direct representation of the motor rotation. The same concept applies to the use of a codestrip to detect linear motion.

Definitions

State Width (S): The number of electrical degrees between a transition in Channel A and the neighboring transition in Channel B. There are 4 states per cycle, each nominally 90°e.

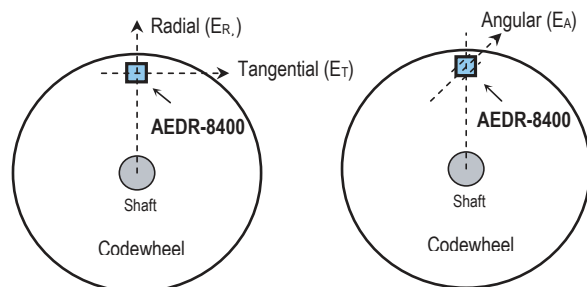

State Width Error (ΔS): The deviation of state width, in electrical degree, from its ideal value of 90°e.

Phase (ϕ): The number of electrical degrees between the center of high state of Channel A and the center of high state of Channel B. Nominally 90°e.

Phase Error ($\Delta\phi$): The deviation of phase, in electrical degree, from its ideal value of 90°e.

Pulse Width (P): The duration of high state of the output, in electrical degree, within one cycle. Nominally 180°e or half a cycle.

Pulse Width Error (ΔP): The deviation of pulse width, in electrical degree, from its ideal value of 180°e.

Count (N): The number of window and bar pair per revolution (CPR) of codewheel. For linear codestrip, defined as the number of window and bar pair per unit length (lines per inch [LPI] or lines per mm [LPmm]).

One Cycle (C): 360 electrical degrees (°e). Equivalent to one window and bar pair.

One Shaft Rotation: 360 mechanical degrees. Also equivalent to N counts (codewheel only).

Line Density: The number of window and bar pair per unit length, expressed in either lines per inch (LPI) or lines per mm (LPmm).

Optical radius (Rop): The distance between the codewheel center and the center of the encoder dome.

Gap (G): The distance from surface of the encoder to the surface of codewheel or codestrip.

Radial and Tangential Misalignment Error (E_R, E_T): For rotary motion, mechanical displacement in the radial and tangential directions relative to the nominal alignment.

Angular Misalignment Error (E_A): Angular displacement of the encoder relative to the tangential line.

Specular Reflectance (R_f): The amount of incident light reflected by a surface. Quantified in terms of the percentage of incident light. A spectrometer can be used to measure specular reflectance of a surface (contact factory for more information).

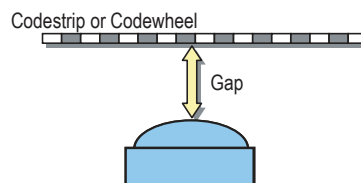

Note: Drawing not to scale

Output waveform

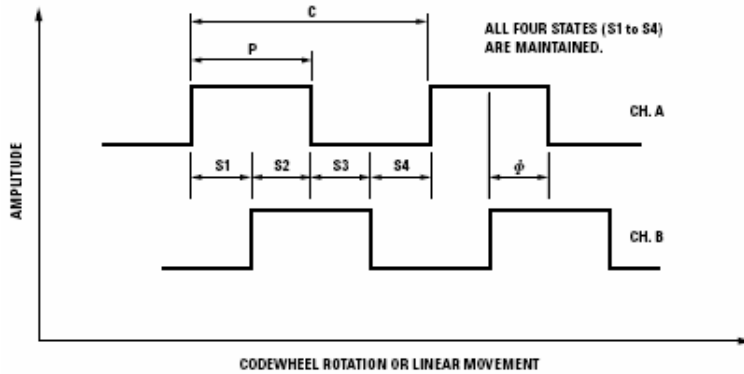

Absolute Maximum Ratings

Storage Temperature, T_S	-40°C to 85°C
Operating Temperature, T_A	-20°C to 85°C
Supply Voltage, V_{CC}	-0.5 V to 7 V
Output Voltage, V_O	-0.5 V to V_{CC}
Output Current per Channel, I_{OUT}	-1.0 mA to 8 mA
ESD	Human Body Model JESD22-A114-A Class 3A
	Machine Model JESD22-A115-A Class B

Notes:

- Exposure to extreme light intensity (such as from flashbulbs or spotlights) may cause permanent damage to the device.
- CAUTION: It is advised that normal static precautions should be taken when handling the encoder in order to avoid damage and/or degradation induced by ESD.
- Proper operation of the encoder cannot be guaranteed if the maximum ratings are exceeded.

Recommended Operating Conditions

Parameter	Symbol	Min.	Typ.	Max.	Units	Notes
Temperature	T_A	-20	25	85	°C	See note 1
Supply Voltage	V_{CC}	2.6	2.8	3.0	V	Ripple < 100mVp-p
LED Current	I_{LED}	5	6	8	mA	See note 2
Load Capacitance	C_L			100	pF	2.7 kΩ Pull-Up
Count Frequency ³	F			15	kHz	
Radial Misalignment	E_R			±0.2	mm	
Tangential Misalignment	E_T			±0.2	mm	
Angular Misalignment	E_A		0	±1.5	deg.	
Codewheel/strip Tilt	C_T		0	1	deg.	
Codewheel/strip Gap	G	0.23	0.43	0.63	mm	

Notes:

- Refer to AEDR-8400 Reliability Datasheet
- LED Current Limiting Resistor: Recommended series resistor = 121Ω (±1%) for 254 LPI and 255Ω (±1%) for 318 LPI.
- Count frequency = velocity (rpm) x N / 60.

Encoding Characteristics

Encoding characteristics over the recommended operating condition and mounting conditions.

Parameter	Symbol	Typical	Maximum	Unit
Pulse Width Error (Channel A)	ΔP	10	75	$^{\circ}e$
Pulse Width Error (Channel B)	ΔP	11	80	$^{\circ}e$
Phase Error	$\Delta\phi$	7	60	$^{\circ}e$

Note:

1. Typical values represent the encoder performance at typical mounting alignment, whereas the maximum values represent the encoder performance across the range of recommended mounting tolerance.

Electrical Characteristics

Characteristics over recommended operating conditions at 25°C.

Parameter	Symbol	Min.	Typ.	Max.	Unit	Notes
Detector Supply Current	I_{CC}		6.0	7.0	mA	
High Level Output Voltage	V_{OH}	2.4			V	$I_{OH} = -0.2mA$
Low Level Output Voltage	V_{OL}			0.4	V	$I_{OL} = 8.0mA$
Rise Time	t_r		400		ns	$C_L = 25pF$
Fall Time	t_f		120		ns	$R_L = 2.7k\Omega$

Recommended Codewheel and Codestrip Characteristics

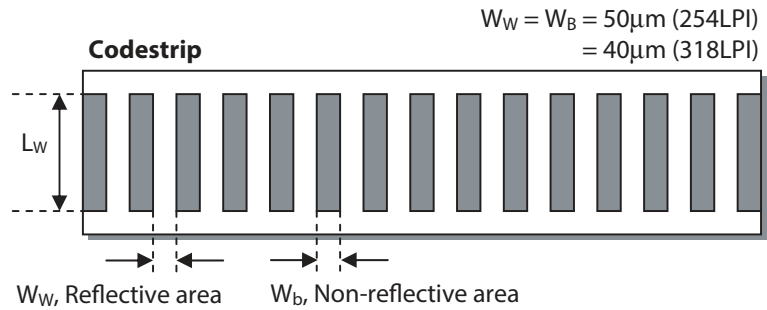
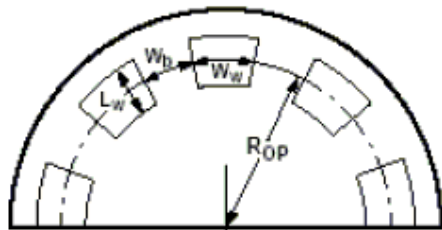

Parameter	Symbol	Min.	Max.	Unit	Notes
Window/bar Ratio	W_W/W_B	0.9	1.1		
Window/bar Length	L_W	1.80 (0.071)	2.31 (0.091)	mm (inches)	
Specular Reflectance	R_f	60	-		Reflective area. See note 1.
		-	10		Non reflective area
Line Density	LPmm (LPI)	10 (254) 12.5 (318)		lines/mm (inch)	
Optical radius	R_{op}	11	-	mm	Recommended $R_{op}=11.0mm$

Notes:

1. Measurements from SMS μ Scan System. Contact factory for more information.
2. Contact factory for more information on compatibility of codewheel/strip.

LED Current Limiting Resistor

A resistor to limit current to the LED is required. The recommended value is 121Ω ($\pm 1\%$) for 254 LPI and 255Ω ($\pm 1\%$) for 318 LPI. The resistor should be placed in series between the 2.8 V supply and pin 1 of the device (V_{LED}). This will result in an LED current of approximately 6mA.

Moisture Sensitive Level

The AEDR-8400 is specified to moisture sensitive level (MSL) 3.

Outline Drawing

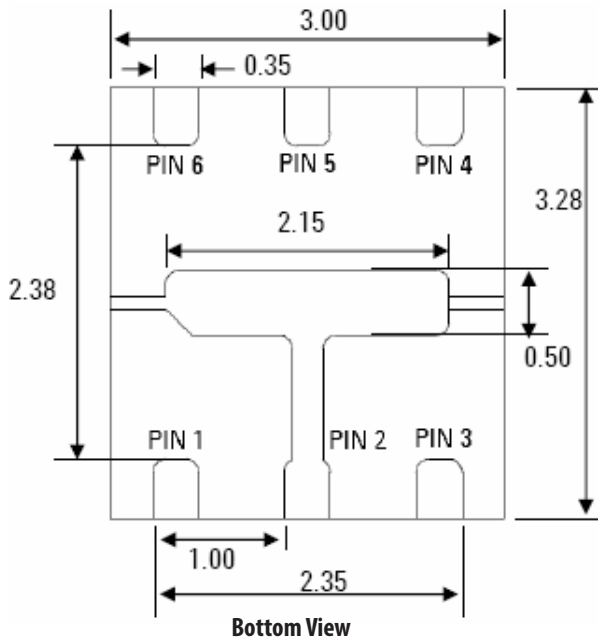

Pin 1 Indication (Top View):

- Refer to the incorporated chamfer, or
- Refer to the upper left pin closer to the emitter; as shown in the diagram.

* All dimensions in millimeter.
Tolerance $x.xx \pm 0.10$ mm.

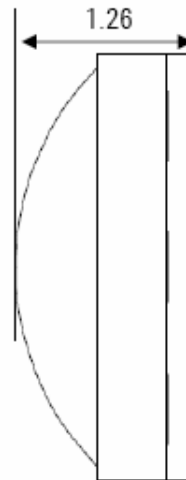
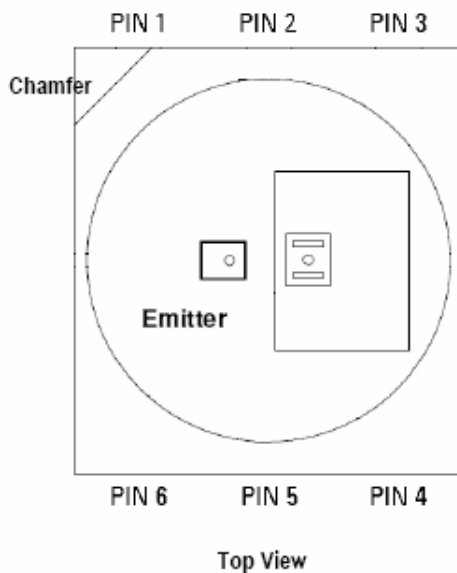

Encoder Pin Configuration

Encoder option	Pin 1	Pin2	Pin3	Pin4	Pin5	Pin6
AEDR-8400	VLED	Gnd	Ch B	Ch A	V _{CC}	Gnd _{LED}

Encoder Orientation

The AEDR-8400 is designed such that both the emitter and detector IC should be placed parallel to the window/bar orientation, as shown. As such, the encoder is tolerant against radial play of $\pm 0.20\text{mm}$.

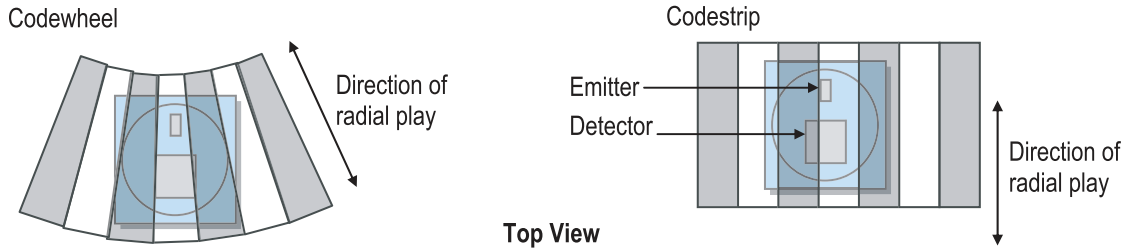

Note: Drawing not to scale.

Direction of Movement

With the emitter side of the encoder placed closer to the codewheel centre, Channel A leads Channel B when the codewheel rotates anti-clockwise and vice versa.

Rotation

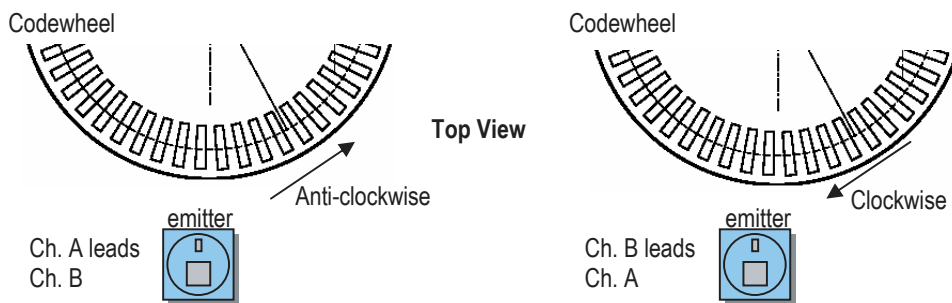

Note: Drawing not to scale.

Rotation

Linear Scale

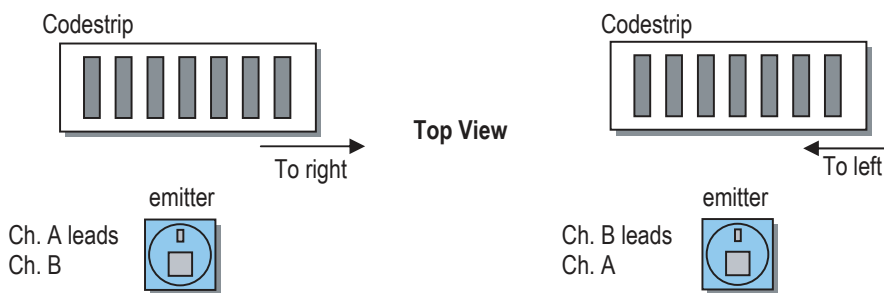

Note: Drawing not to scale.

Linear Scale

Recommended Land Pattern for AEDR-8400

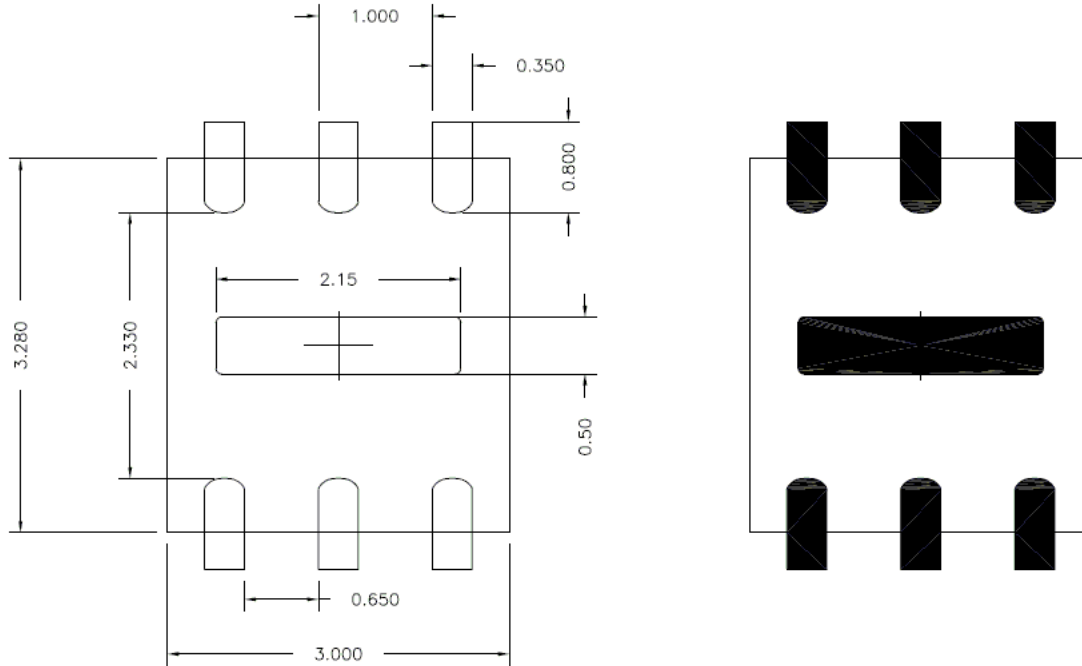

AEDR-8400 Pad Soldering

In order to provide adequate mechanical strength for the AEDR-8400 encoder, it is strongly recommended the all pin-outs need to be soldered including the encoder center pad. However, external circuitry routing on PCB / FPC could actually route pin 2, pin 6 and center pad together hence to have a common ground for the encoder. This could help to simplify the circuitry routing.

Likewise, the emitter input voltage supply (V_{LED}) could share a common voltage supply with detector IC voltage supply (V_{CC}) i.e. 2.8V typically. Note that a series resistor is necessary to prevent excess current from flowing through the emitter. Refer page 6.

Possible common ground routing:

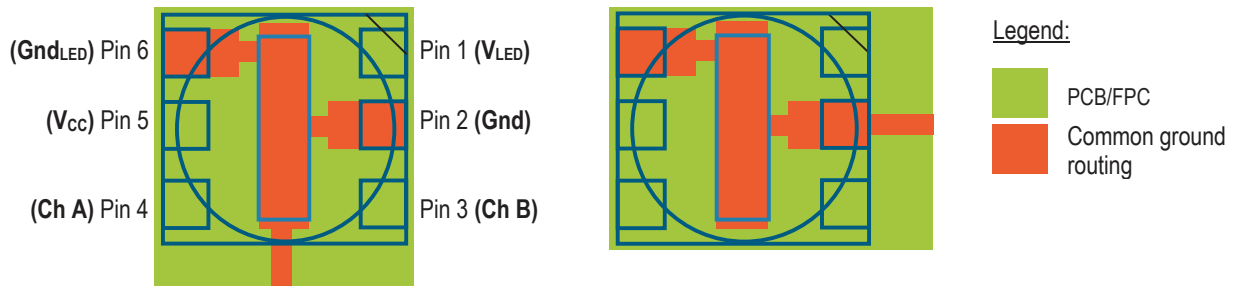

AEDR-8400 LED Specifications

The AEDR-8400 254 LPI is using the AlGaInP LED with typical wavelength at 624nm. The AEDR-8400 318 LPI is using the IR base LED with typical wavelength at 870nm.

Recommended Lead-free Reflow Soldering Temperature Profile

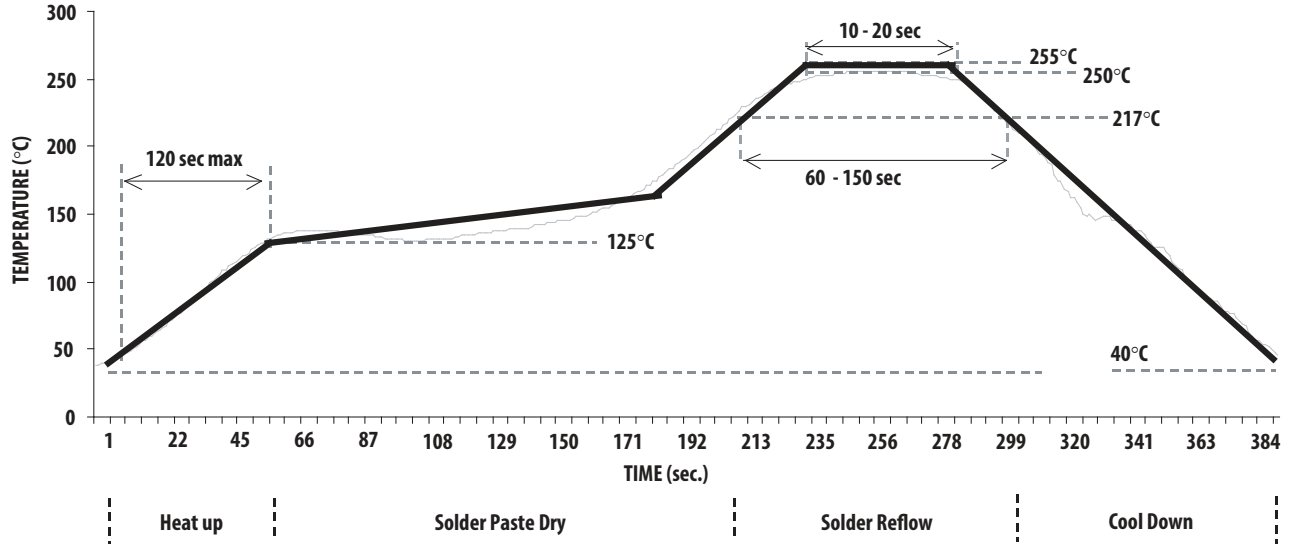

Preheat Temperature 40 °C to 125 °C = 120 sec max

Temperature maintain above 217 °C = 60 – 150 sec

Peak Temperature = 255 ± 5°C

Time above 250 °C = 10 – 20 sec

Note: Due to treatment of high temperature, AEDR-8400 compound may turn yellow after IR reflow.

Ordering Information

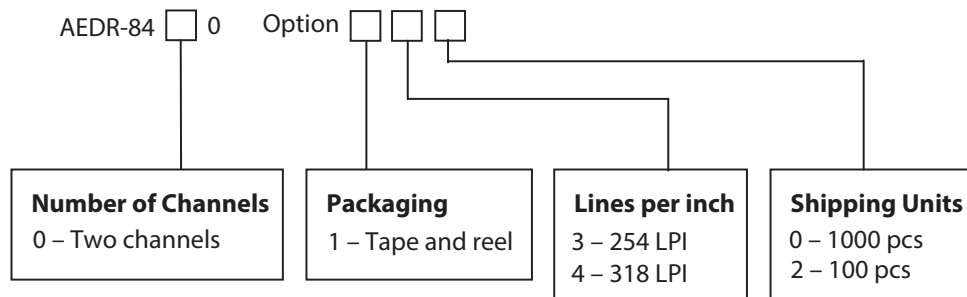

Note: Encoders are packed in tape of quantity 1000pcs or 100pcs

For product information and a complete list of distributors, please go to our web site: www.avagotech.com

Avago Technologies, and the A logo are trademarks of Avago Technologies in the United States and other countries. Data subject to change. Copyright © 2005-2015 Avago Technologies. All rights reserved. Obsoletes AV01-0142EN AV02-0262EN - October 27, 2015

