

Universal Input
85-264Vac or 110-340Vdc

OBSOLETE PRODUCT

Contact Factory for Replacement Model

FEATURES

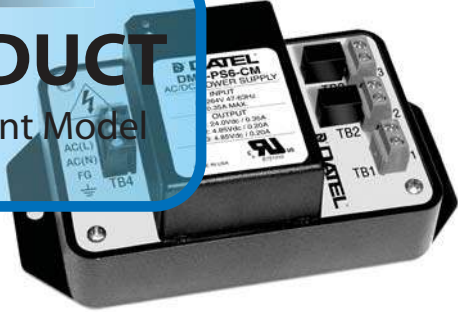

- Up to 80% efficient single, dual, and triple-output model
- Individual, fully-isolated outputs:
3000Vac on main
4000V double-isolation on auxiliaries
- Available with +5V, +12V, and +24V outputs
- Low noise: 40mVp-pk on main, 8mVp-pk on auxiliaries; Ideal for sensitive instrumentation
- Universal input: 85-264Vac @ 47-63Hz or 110-340Vdc
- Choice of 5, 10, or 16W models for minimal system power-consumption
- Standby power consumption as low as 0.6W
- Short-circuit protection on all outputs; OVP on main output
- Built-in ac mains fuse & 'Power On' indicator
- 5W models operate up to 5 LED-display DPM's
- Vibration-resistant, chassis-mount modular packages
- EMC compliant; UL/CSA recognized
- Low cost!

Murata Power Solution's DMS-PS-CM Series of high-efficiency, chassis mount AC/DC power supplies feature low noise (40mV on main, 8mV on auxiliaries), fully-isolated +24, +12V, and +5V outputs, making them perfect for powering today's complex instrumentation. A high-current main output is isolated from the AC line by 3000Vac. In dual- and triple-output models, the low-current auxiliary outputs are isolated from the main output by 1000Vdc, and from each other by 2000Vdc, effectively providing double isolation from the AC line! This unprecedented isolation eliminates ground loop problems in complex, multiple-instrument applications.

Full-load efficiencies of up to 80% and output-power ratings of 5, 10 or 16 Watts, combine to ensure minimal ac power consumption. For intermittent use or low-power applications, the 5-Watt model's no-load quiescent consumption with a nominal 120Vac input is a mere 0.6 Watts---that's nearly seven times less than a standard 4W

night light! These low cost, high-efficiency power supplies can significantly reduce long-term electricity costs in low (<5Watts) to medium (<16Watts) power applications.

All DMS-PSX-CM power supplies feature universal inputs of 85-264Vac 50/60Hz, built-in line fuses, and on-board 'Power On' LED indicators. At full rated load, hold-up time is typically 20ms at 120Vac, and 80ms at 230Vac. All outputs provide indefinite short-circuit protection and, for added reliability, the main high-current output also includes overvoltage protection. A rugged, vibration-proof, chassis mount package incorporates large, shock-resistant terminal blocks for all I/O connections.

Multiple outputs, low noise, low cost, high efficiency, double isolation, and rugged construction combine to make DMS-PSX-CM Series AC/DC power supplies the ideal choice for powering today's sensitive instrumentation, and any electronic device that requires a reliable dc voltage!

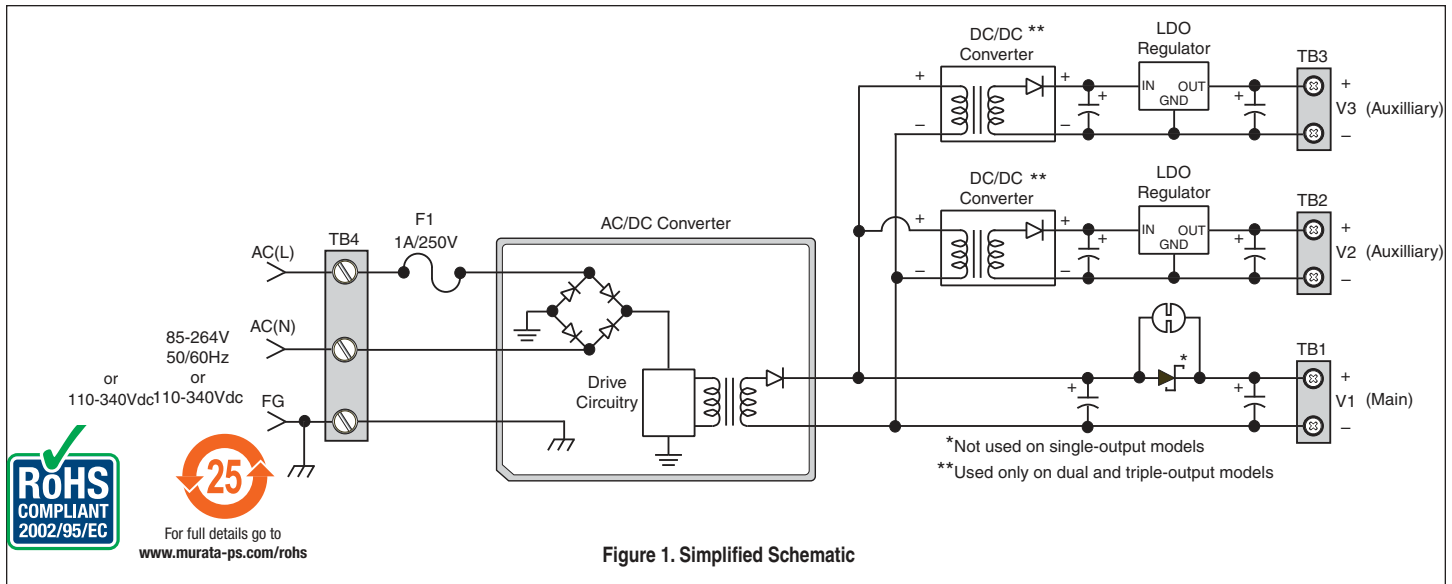

Figure 1. Simplified Schematic



For full details go to www.murata-ps.com/rohs

High Efficiency, AC/DC Instrumentation Power Supplies with Individually Isolated Outputs

Performance/Functional Specifications

Typical at $T_A = +25^\circ\text{C}$ and $V_{IN} = 85\text{-}264\text{V}$ @ 47-63Hz

AC Input	
Input Voltage Range, All models ^①	85-264V @ 47-63Hz
Input Current (115V/230V, typ.):	
5-Watt Models	0.15A/0.07A
10-Watt Models	0.3A/0.13A
16-Watt Models	0.33A/0.16A
Inrush Current (All models, typical peak):	
@ 115Vac	14.1A
@ 230Vac	32.5A
Isolation (Min.):	
Output V1 to AC Input	3000Vac
Outputs V2 & V3 to AC Input	3000Vac + 1000Vdc
AC Input to Frame Ground	1500Vac
Output V1 to Frame Ground	500Vac
Outputs V2 & V3 to Frame Ground	500Vac + 1000Vdc
Outputs V2 & V3 to Output V1	1000Vdc
Output V2 to Output V3	2000Vdc
Frame Ground Leakage Current (Max.):	
@ 115Vac	0.5mA
@ 230Vac	3.5mA
Switching Frequency (Typical):	
V1 (5W and 10W models)	75kHz
V1 (16W models)	83kHz
V2 & V3 (All models)	100kHz
Line Fuse (Built-in)	1A/250Vac, 5 x 20mm, meeting IEC60127-2, sheet 3 specification for time lag fuses (slow-blow)
AC Mains Terminal Block (TB4):	
Wire Size & Type	14-20AWG (2.5 to 0.5mm ²), solid or stranded
Insulation Strip Length	0.25 inches (6.4mm)
Screw Tightening Torque	4.4 pound-inches (0.5Nm)
Rated Voltage	630V (VDE 0110-V. Group 2); 250V (VDE 0110-V. Group 3)
EMI (All models)	Meets CISPR Pub. 22 & FCC Class B
Safety Approvals	Pending
DC Outputs	
Line Regulation (All outputs)	±0.1% (max)
Load Regulation: ^②	
V1 (All models)	±2%
V2 & V3 (All models)	±0.2% (max)
Output Accuracy (Max.):	
V1 (All models)	±2.0%
V2 & V3 (All models)	±2.5%
Hold-Up Time (47-63Hz):	
@ 115Vac	20mSec. typ.
@ 230Vac	80mSec. typ.
Noise & Ripple	
(All models, 20MHz bandwidth):	See Noise & Ripple graphs
V1	40mVp-pk (typ.)
V2 & V3	8mVp-pk (typ.)
Transient Response ^③	See Transient Response graphs

DC Outputs (continued)	
Efficiency (Typ. @ 120Vac, full load):	
Single Output Models	75%
Dual Output Models	73%
Triple Output Models	71%
DC-Output Terminal Blocks (TB1, TB2, TB3):	
Wire Size & Type	16-20AWG (1.5 to 0.5mm ²), solid or stranded
Insulation Strip Length	0.25 inches (6.4mm)
Screw Tightening Torque	3.6 pound-inches (0.4Nm)
Short Circuit Protection (All outputs)	Foldback, self-recovering
Overvoltage Protection V1 (max.)	134% x Vout
Environmental	
Operating Temperature	0 to +50°C @ full rated power; -25 to +70°C @ 50% rated power (see Figure 3)
Storage Temperature	-40 to +85°C
Cooling	Free air convection with derating (see Figure 3 and Technical Notes)
Humidity (Non-condensing)	0 to 85%
Physical	
Dimensions	See Mechanical Specifications
Weight:	
5 Watt Models	5.8 ounces (165 grams)
10 Watt Models	6.9 ounces (195 grams)
16 Watt Models	7.9 ounces (223 grams)
Case Materials:	
Outer Case	ABS, UL94 5VA
DC/DC Modules	Phenolic, UL94 V-0
AC/DC Modules	Plastic, UL94 V-1

- ① All models will also operate from a regulated and filtered 110 to 340Vdc input.
- ② Unless otherwise specified, load regulation is measured with the output under test undergoing a load change of 100% to 50% at nominal line input and, when applicable, with all other outputs operating at 50% of rated load.
- ③ Transient response is defined as the output returning to within its specified tolerance in 10ms or less, following a 90% load change.

Ordering Information and Selection Guide

MPS Part No.	Rated Power	Efficiency ①	V1 Output	V2 Output	V3 Output
DMS-PS1-CM	5 Watts	75%	5Vdc/1A	—	—
DMS-PS2-CM	5 Watts	73%	5Vdc/0.65A	4.85Vdc/0.2A	—
DMS-PS3-CM	5 Watts	71%	5Vdc/0.35A	4.85Vdc/0.2A	4.85Vdc/0.2A
DMS-PS4-CM	10 Watts	80%	24Vdc/0.45A	—	—
DMS-PS5-CM	10 Watts	75%	24Vdc/0.35A	4.85Vdc/0.2A	—
DMS-PS6-CM	10 Watts	73%	24Vdc/0.30A	4.85Vdc/0.2A	4.85Vdc/0.2A
DMS-PS7-CM	16 Watts	82%	24Vdc/0.70A	—	—
DMS-PS8-CM	16 Watts	76%	24Vdc/0.60A	4.85Vdc/0.2A	—
DMS-PS9-CM	16 Watts	74%	24Vdc/0.55A	4.85Vdc/0.2A	4.85Vdc/0.2A
DMS-PS10-CM	16 Watts	82%	12Vdc/1.35A	—	—

① Efficiency typical @120V/60Hz

TECHNICAL NOTES

IMPORTANT! To ensure safe and reliable operation, DMS-PS-CM power supplies must be installed and serviced by qualified personnel. Contact Murata Power Solutions if there is any doubt regarding their installation and/or operation. Please read all of the following technical and application notes BEFORE installing or making connections to DMS-PS-CM power supplies.

Warnings (Marking)



Caution, unit may become hot in normal operation, thereby creating a potential burn hazard. Disconnect ac mains and then allow unit to cool before servicing.
Reference document: IEC 417, No. 5041.



Dangerous, potentially lethal voltages are present during normal operation. Disconnect ac mains before servicing.
Reference document: IEC 417, No. 5036.



Caution, refer to accompanying documents for more information. Reference document: ISO 3864, No. B.3.1.

- Shock Hazard:** DMS-PS-CM Series power supplies feature touch-proof terminals blocks and fully-isolated plastic construction, thereby greatly reducing the risk of electrical shock. However, these are mains-powered devices whose operation is derived from hazardous and potentially lethal voltages.

All service and installation must be performed by qualified personnel, with the ac supply voltage de-energized. Before making connections to any of the unit's terminal blocks, use a digital voltmeter to verify that the ac supply is de-energized (off).

- AC Supply Fuse (F1):** All DMS-PS-CM Series power supplies are equipped with a built-in 1A/250V time-lag fuse. Replacement fuses must be of the same type and rating; please refer to the Functional Specifications section of this datasheet for more information. F1 is conservatively rated in order to reduce nuisance tripping which might occur during power-up or output overload conditions. However, F1 is primarily intended to provide protection in the event of catastrophic failure in the DMS-PS-CM's ac/dc converter.

- Fuse Replacement:** If any dc-output drops to zero volts, and no fault conditions exist within the external load circuitry or the ac mains, F1 may have failed. F1 is located on the circuit (etch) side of the pc-board. Fuse replacement is performed by first de-energizing and then disconnecting the ac mains from TB4. Next, disconnect all load wiring from TB1, TB2, and TB3. Lastly, remove the four screws that secure the pc-board to the plastic case. After making sure that the new fuse is securely attached to its mounting clips, re-assemble the unit using all four screws. Reconnect all input and output wiring and re-apply ac power.

If the unit still does not operate properly, and the ac supply at TB4 is measured to be within its specified operating range, the power supply is defective and must be replaced. Except for F1, DMS-PS-CM supplies contain no other user-serviceable components.

- Wire Gauges and Fusing:** All wiring connected to the DMS-PS-CM's terminal blocks must meet the requirements specified in the Functional Specifications section. All ac supply and load wiring must be rated for the voltages and currents they will conduct and must comply with any code or application-mandated requirements pertaining to the user's specific installation. Applications subject to vibration should include adequate strain reliefs on both input and output wiring. Install the strain reliefs within 2-3 inches (5-7.5cm) of the terminal blocks.

It is recommended that all wiring be rated for 600V and 105°C operation (UL1015 type, for example). Also, wire insulation must be stripped to within ±10% of the dimensions shown in Figure 2. All wires must be inserted into their respective terminal blocks such that the screw terminal does not pinch their insulation. **No more than two wires should be connected to any single terminal on TB1 through TB4.** If two wires are attached to a single terminal, be sure to use only two 20AWG (0.5mm²) wires on TB1, TB2, and TB3, and only two 18 or 20AWG (0.75 or 0.5mm²) wires on TB4.

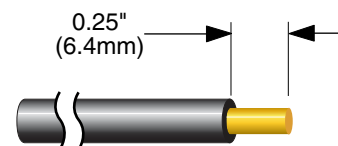

Figure 2. Insulation Strip Length

High Efficiency, AC/DC Instrumentation Power Supplies with Individually Isolated Outputs

The ac-mains circuit supplying power to DMS-PS-CM supplies must be fused according to the current rating of the wire gauge used, in accordance with applicable regulatory codes. The built-in 1ampere line fuse (F1) only protects the module itself from destructive over currents.

- 5. AC Mains Connections (TB4):** To ensure EMI-compliant operation, all three ac-supply inputs must be properly connected to TB4. Never operate any DMS-PS-CM power supply without a ground connection to TB4's 'FG' terminal.

On 120Vac 50/60Hz mains, connect the black or "hot" lead to 'AC(L)', the white or "neutral" lead to 'AC(N)', and the supply ground (earth) to 'FG' (Frame Ground). On 220V 50/60Hz ac mains with line and neutral conductor-designations, connect the line to AC(L), the neutral to AC(N), and the ground to 'FG'.

- 6. Connector Torque Ratings:** It is extremely important to tighten all input and output terminal blocks securely. TB4's screw terminals must be torqued to 4.4 pound-inches (0.5Nm). TB1, TB2, and TB3 must be torqued to 3.6 pound-inches (0.4Nm). Proper tightening will minimize losses and ensure safe, reliable operation.

- 7. 'Power On' LED:** The Power On LED indicates that the unit has ac-power applied and its V1 dc-output is operational. However, the power-on LED's illumination does not imply nor guarantee that the unit's dc-outputs are within their specified accuracy.

- 8. Output Adjustment:** The main output, V1, on all 5, 10, and 16W models is adjustable by approximately -10% to +15%. V1's adjustment potentiometer is accessed via a small hole located next to the Power-On LED. While not recommended, field adjustment of single-output models can be performed within the tolerance window noted above. However, keep in mind that the unit's maximum output power capability must not be exceeded. For example, increasing V1's output voltage by 10% produces a corresponding 10% reduction in V1's maximum output current.

On dual-and triple-output units, V1 is factory calibrated with all outputs simultaneously loaded to 100% of their rated current. On all dual- and triple output models, adjusting V1 under any condition other than those just noted (i.e., all outputs loaded to their full rated current) will

adversely affect the operation and stability of auxiliary outputs V2 and V3. On these models, V1 must be adjusted to within ±2 % of its nominal value (+5.0V, +12.0V, or +24.0V, depending on model).

- 9. Temperature Derating (See Figure 3):** All DMS-PS-CM supplies are specified to operate at their full rated power over the temp range of 0°C to +50°C in still air (convection cooling) without any thermal derating. For operation over +50°C in still air, derate the output power linearly by 2.5% per °C down to 50% rated power at +70°C. To operate the units at full rated power between +50°C and +70°C, a minimum forced-airflow of 100 LFM is required. For operation below 0°C, derate the output power linearly by 2.0% per °C down to 50% rated power at -25°C.

Unless forced air with the velocity noted above is employed, DMS-PS-CM supplies should never be mounted upside down (terminal blocks facing down). Also, always provide sufficient clearances in order to ensure adequate airflow around the supply.

- 10. V1 Peak Capabilities:** DMS-PS-CM power supplies have a maximum continuous output-current rating that's specified in the Ordering and Selection Guide. In addition, each model's V1 output can intermittently supply 120% of its continuous rated current for short periods of time if the duty cycle is less than 10%. Peak current ratings do not apply to the auxiliary outputs V2 or V3.

- 11. Isolated Outputs:** Unlike the majority of competitive ac/dc power supplies, all dual- and triple-output DMS-PS-CM power supplies feature fully-isolated outputs. This is an important feature when, for reasons of high common mode voltages, an instrument's input circuit must be isolated from the system ground. All V1 outputs are isolated from the ac mains by a minimum of 3000Vac, while auxiliary outputs V2 and V3 are isolated from one another by 2000Vdc, and from V1 by 1000Vdc. The low noise, double-isolated auxiliaries are ideal for powering sensitive instrumentation that requires low ac leakage-currents.

All ac/dc and dc/dc power components utilized in the construction of DMS-PS-CM power supplies are 100% hi-pot tested during their manufacturing processes. In addition, after final assembly by MPS, all models are subjected to an additional hi-pot testing consisting of 1000Vac sequentially applied between the ac mains input and each output, and between each output and all other outputs.

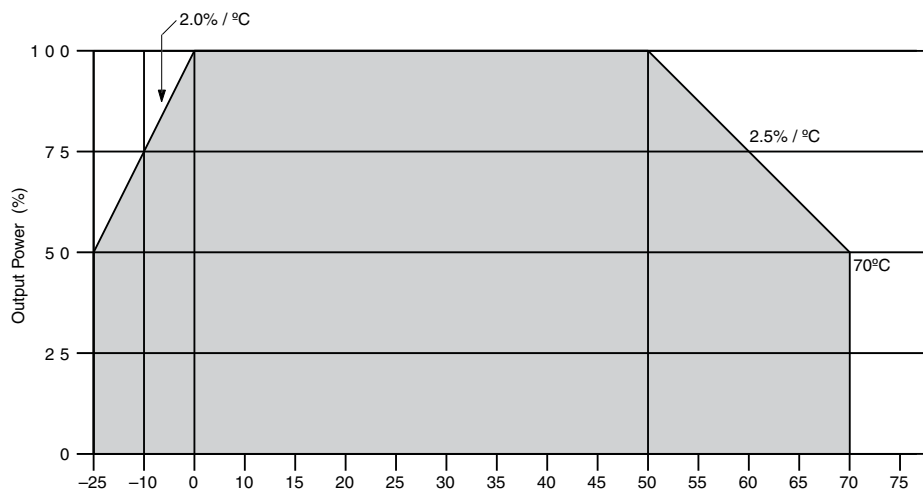

Figure 3. Temperature Derating

High Efficiency, AC/DC Instrumentation Power Supplies with Individually Isolated Outputs

Application Information

1. Chassis Mounting Considerations: In order to minimize self-heating, DMS-PS-CM power supplies should always be mounted in either a vertical or horizontal position. Avoid mounting units upside-down or in close proximity to other heat-generating devices. Also, be sure to use the mounting hardware described in Figure 4 below in order to ensure a secure, vibration-resistant installation.

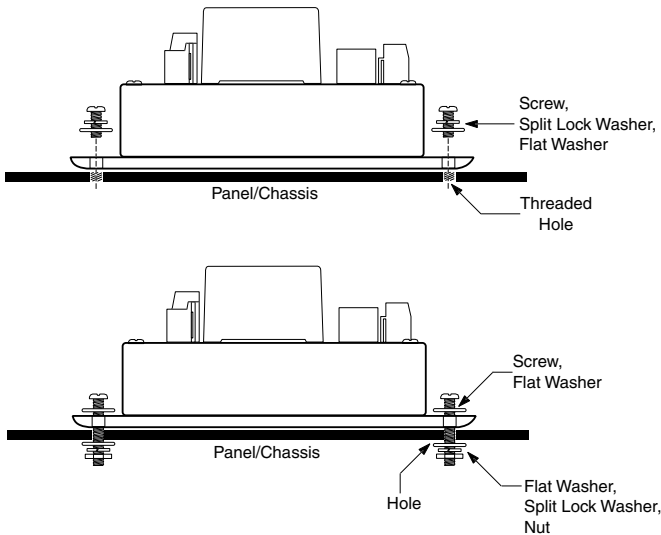

Figure 4. Chassis Mounting

2. Bipolar Operation (See Figure 5): DMS-PS-CM power supplies' fully isolated outputs allow for the generation of bipolar (positive and negative) supply voltages. Bipolar outputs can be used to power dual-supply operational amplifiers, as well as any other type of instrumentation that requires bipolar supply voltages. However, please keep in mind that when connecting and operating any two outputs in this fashion, each output retains its maximum current rating.

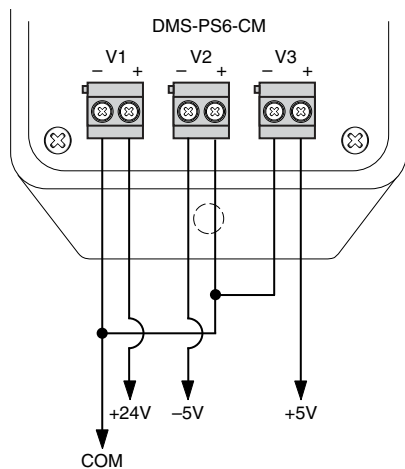

Figure 5. Bipolar Connections

3. Model Selection & Energy Conservation: In order to achieve the lowest possible energy consumption, be sure to determine your application's total current requirements. This is especially true when using DMS-PS-CM supplies to power DATEL's energy-efficient LED and/or LCD display digital panel meters (DPMs) and process monitors. In general, choose a power supply that will accommodate your maximum current consumption plus a 20% margin. Choosing the lowest-wattage model suitable for a given application will provide lower procurement costs and lower long-term operating costs.

When calculating total current requirements in installations employing three or more DMS-Series meters, it is acceptable practice to use each meter's typical current consumption rating. However, be sure to consult the relevant product datasheets for all instrumentation comprising your application.

For applications where DMS-PS-CM power supplies will be powering only Murata Power Solution's DPM's, a 5-Watt DMS-PS3-CM can power up to four, standard intensity ('-RS' suffix) red-LED DMS-30PC meters: two meters on V1, and one meter each on V2 and V3. The same DMS-PS3-CM could also be used to power over 40 low-power red DMS-30PC meters ('-RL' suffix), or over 800 DMS-30LCD non-backlit meters! Of course, these statements are made without regard to ground-loop problems that may be encountered when powering 800 DPM's from a single power supply.

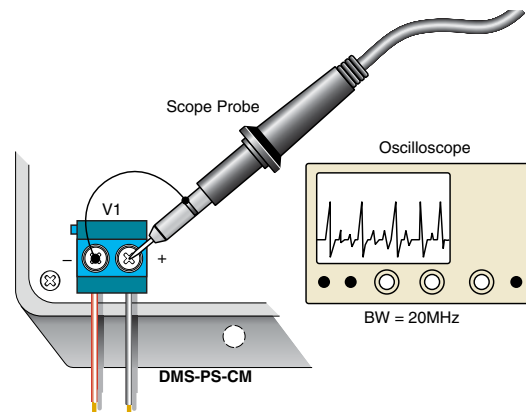
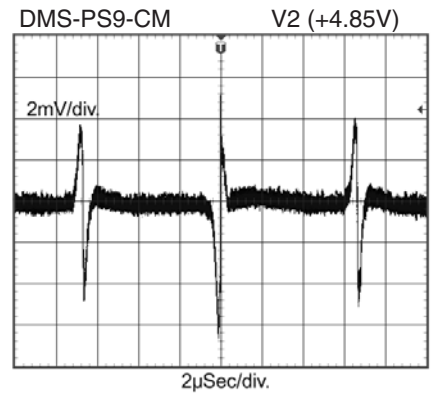
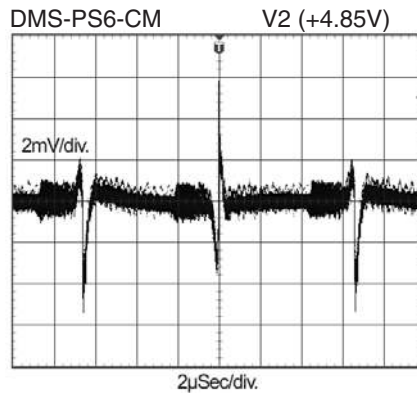
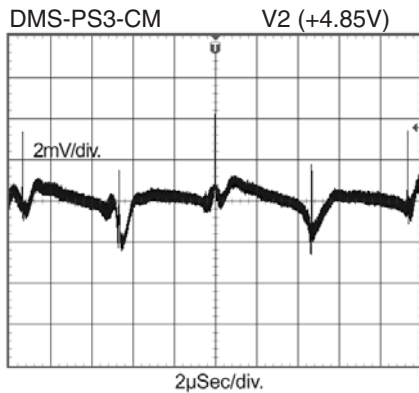
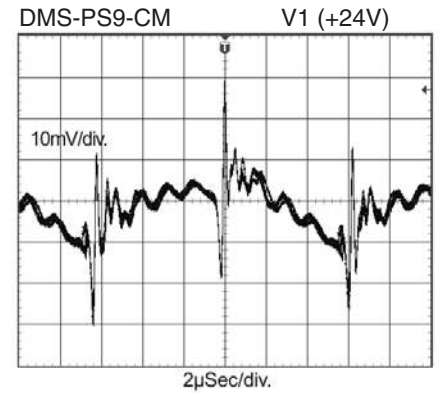
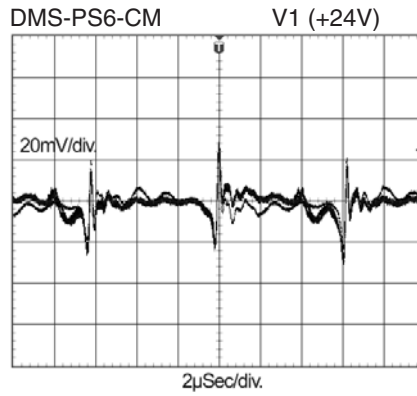
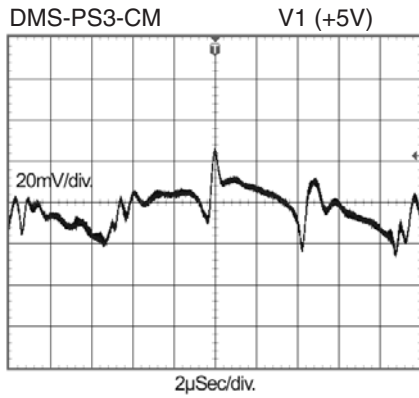

Figure 6. Measuring Ripple and Noise

Typical Performance Curves $T_A = +25^\circ\text{C}$, $V_{IN} = 120\text{V}$ @ 60Hz

Noise and Ripple - 100% Load, 20MHz Bandwidth



Typical Performance Curves $T_A = +25^{\circ}\text{C}$, $V_{IN} = 120\text{V}$ @ 60Hz

Transient Response - 10% to 100% Load Step

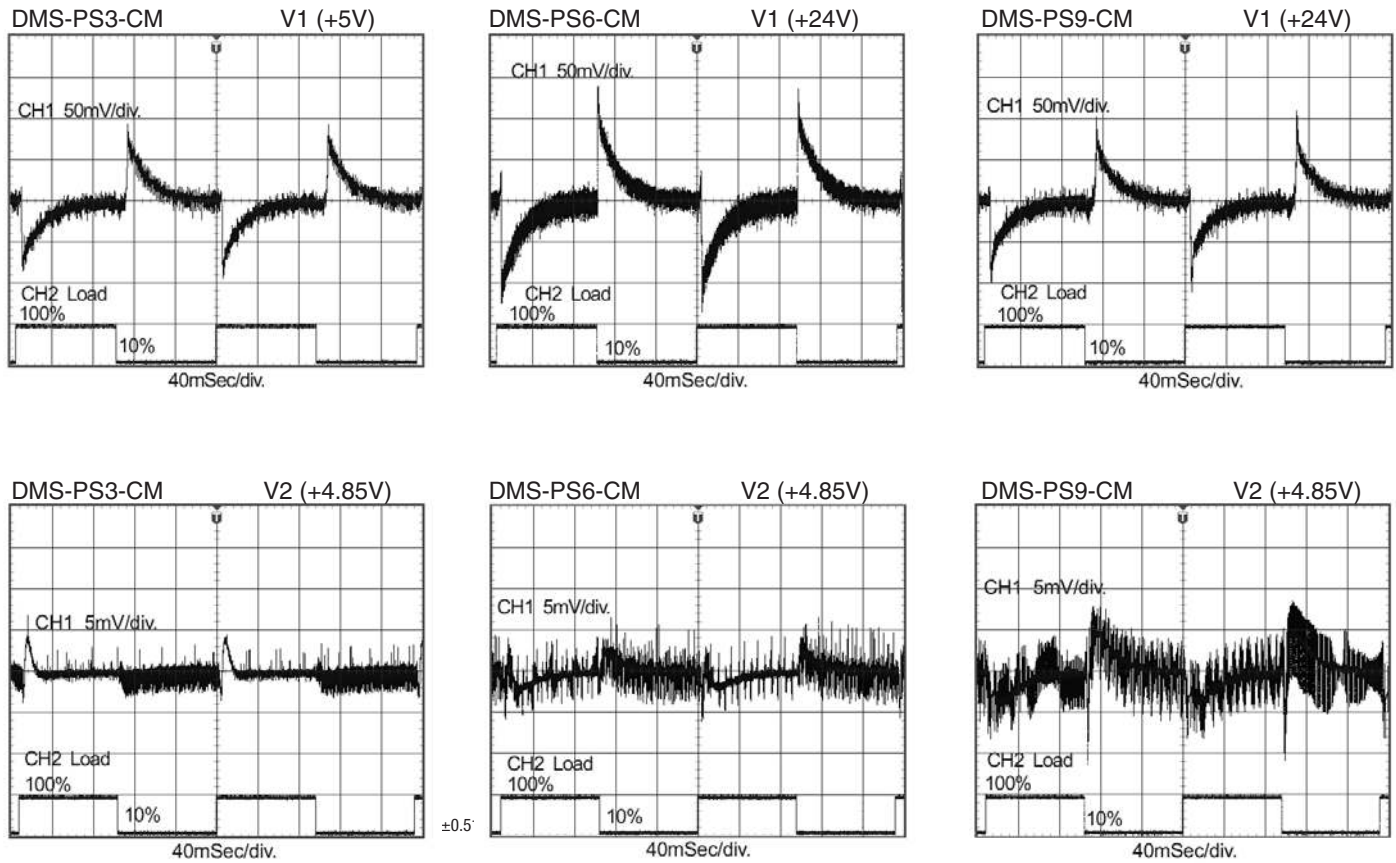

High Efficiency, AC/DC Instrumentation Power Supplies with Individually Isolated Outputs

Mechanical Specifications

MECHANICAL DIMENSIONS: Inches (mm)
 TOLERANCES: 2 PL DEC ±0.02 (±0.51)
 3 PL DEC ±0.010 (±0.254)

