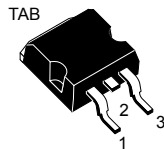
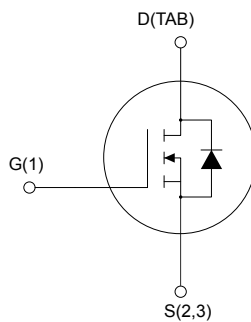


## Silicon carbide Power MOSFET 1200 V, 20 A, 189 mΩ (typ., $T_J=150\text{ °C}$ ), in an H<sup>2</sup>PAK-2 package


 H<sup>2</sup>PAK-2


NCHG1DTABS23



### Features

- Very tight variation of on-resistance vs. temperature
- Very high operating junction temperature capability ( $T_J = 175\text{ °C}$ )
- Very fast and robust intrinsic body diode
- Low capacitance

### Applications

- Solar inverters, UPS
- Motor drives
- High voltage DC-DC converters
- Switch mode power supplies

### Description

This silicon carbide Power MOSFET is produced exploiting the advanced, innovative properties of wide bandgap materials. This results in unsurpassed on-resistance per unit area and very good switching performance almost independent of temperature. The outstanding thermal properties of the SiC material allow designers to use an industry-standard outline with significantly improved thermal capability. These features render the device perfectly suitable for high-efficiency and high power density applications.

#### Product status link

[SCT20N120H](#)

#### Product summary

<b>Order code</b>	SCT20N120H
<b>Marking</b>	SCT20N120
<b>Package</b>	H <sup>2</sup> PAK-2
<b>Packing</b>	Tape and reel

# 1 Electrical ratings

**Table 1. Absolute maximum ratings**

Symbol	Parameter	Value	Unit
$V_{DS}$	Drain-source voltage	1200	V
$V_{GS}$	Gate-source voltage	-10 to 25	V
$I_D$	Drain current (continuous) at $T_C = 25\text{ °C}$	20	A
$I_D$	Drain current (continuous) at $T_C = 100\text{ °C}$	16	A
$I_{DM}^{(1)}$	Drain current (pulsed)	45	A
$P_{TOT}$	Total power dissipation at $T_C = 25\text{ °C}$	150	W
$T_{stg}$	Storage temperature range	-55 to 175	°C
$T_j$	Operating junction temperature range		°C

1. Pulse width limited by safe operating area.

**Table 2. Thermal data**

Symbol	Parameter	Value	Unit
$R_{thj-case}$	Thermal resistance junction-case	1	°C/W
$R_{thj-pcb}^{(1)}$	Thermal resistance junction-pcb	35	°C/W

1. When mounted on 1 inch<sup>2</sup> FR-4 board, 2 oz Cu.

## 2 Electrical characteristics

( $T_{CASE} = 25\text{ °C}$  unless otherwise specified).

**Table 3. On/off states**

Symbol	Parameter	Test conditions	Min.	Typ.	Max.	Unit
$I_{DSS}$	Zero gate voltage drain current	$V_{GS} = 0\text{ V}, V_{DS} = 1200\text{ V}$			100	$\mu\text{A}$
		$V_{GS} = 0\text{ V}, V_{DS} = 1200\text{ V}, T_J = 175\text{ °C}$		50		
$I_{GSS}$	Gate-body leakage current	$V_{DS} = 0\text{ V}, V_{GS} = -10\text{ to }22\text{ V}$			100	nA
$V_{GS(th)}$	Gate threshold voltage	$V_{DS} = V_{GS}, I_D = 1\text{ mA}$	2	3.5		V
$R_{DS(on)}$	Static drain-source on-resistance	$V_{GS} = 20\text{ V}, I_D = 10\text{ A}$		169	239	m $\Omega$
		$V_{GS} = 20\text{ V}, I_D = 10\text{ A}, T_J = 150\text{ °C}$		189		
		$V_{GS} = 20\text{ V}, I_D = 10\text{ A}, T_J = 175\text{ °C}$		203		

**Table 4. Dynamic**

Symbol	Parameter	Test conditions	Min.	Typ.	Max.	Unit
$C_{iss}$	Input capacitance	$V_{DS} = 400\text{ V}, f = 1\text{ MHz}, V_{GS} = 0\text{ V}$	-	650	-	pF
$C_{oss}$	Output capacitance		-	65	-	pF
$C_{rss}$	Reverse transfer capacitance		-	14	-	pF
$Q_g$	Total gate charge	$V_{DD} = 800\text{ V}, I_D = 10\text{ A}, V_{GS} = 0\text{ to }20\text{ V}$	-	45	-	nC
$Q_{gs}$	Gate-source charge		-	7	-	nC
$Q_{gd}$	Gate-drain charge		-	11.7	-	nC
$R_g$	Gate input resistance		$f=1\text{ MHz}, I_D = 0\text{ A}$	-	7	-

**Table 5. Switching energy (inductive load)**

Symbol	Parameter	Test conditions	Min.	Typ.	Max.	Unit
$E_{on}$	Turn-on switching energy	$V_{DD} = 800\text{ V}, I_D = 10\text{ A}, R_G = 6.8\text{ }\Omega, V_{GS} = -2\text{ to }20\text{ V}$	-	160	-	$\mu\text{J}$
$E_{off}$	Turn-off switching energy		-	90	-	$\mu\text{J}$
$E_{on}$	Turn-on switching energy	$V_{DD} = 800\text{ V}, I_D = 10\text{ A}, R_G = 6.8\text{ }\Omega, V_{GS} = -2\text{ to }20\text{ V}, T_J = 150\text{ °C}$	-	165	-	$\mu\text{J}$
$E_{off}$	Turn-off switching energy		-	100	-	$\mu\text{J}$

**Table 6. Switching times**

Symbol	Parameter	Test conditions	Min.	Typ.	Max.	Unit
$t_{d(on)V}$	Turn-on delay time	$V_{DD} = 800\text{ V}, I_D = 10\text{ A}, R_G = 0\text{ }\Omega, V_{GS} = 0\text{ to }20\text{ V}$	-	10	-	ns
$t_{f(V)}$	Fall time		-	17	-	ns
$t_{d(off)V}$	Turn-off delay time		-	27	-	ns

Symbol	Parameter	Test conditions	Min.	Typ.	Max.	Unit
$t_{r(V)}$	Rise time	$V_{DD} = 800 \text{ V}$ , $I_D = 10 \text{ A}$ , $R_G = 0 \text{ } \Omega$ , $V_{GS} = 0 \text{ to } 20 \text{ V}$	-	16	-	ns

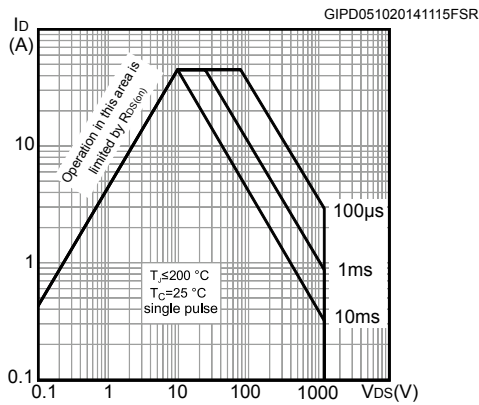
**Table 7. Reverse SiC diode characteristics**

Symbol	Parameter	Test conditions	Min.	Typ.	Max.	Unit
$V_{SD}$	Diode forward voltage	$I_F = 5 \text{ A}$ , $V_{GS} = -5 \text{ V}$	-	3.6	-	V
$t_{rr}$	Reverse recovery time	$I_{SD} = 10 \text{ A}$ , $V_{GS} = -5 \text{ V}$ , $V_R = 800 \text{ V}$ , $dif/dt = 1650 \text{ A}/\mu\text{s}$	-	15	-	ns
$Q_{rr}$	Reverse recovery charge		-	75	-	nC
$I_{rrm}$	Peak reverse recovery current		-	8	-	A

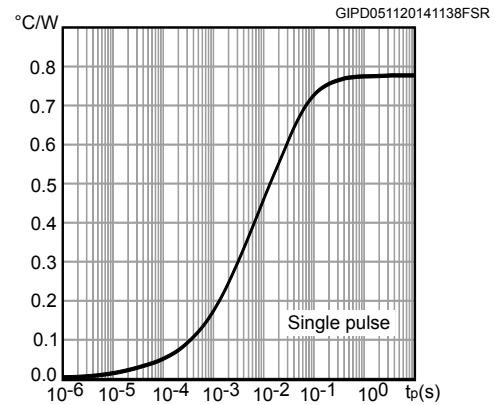
## 2.1 Electrical characteristics (curves)

Characteristic curves are based on SCT20N120 in HiP247 package option

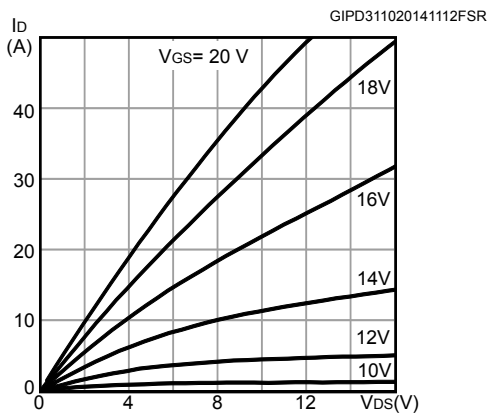
**Figure 1. Safe operating area**



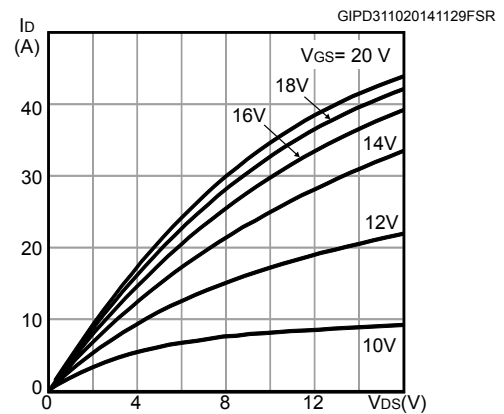
**Figure 2. Maximum transient thermal impedance**



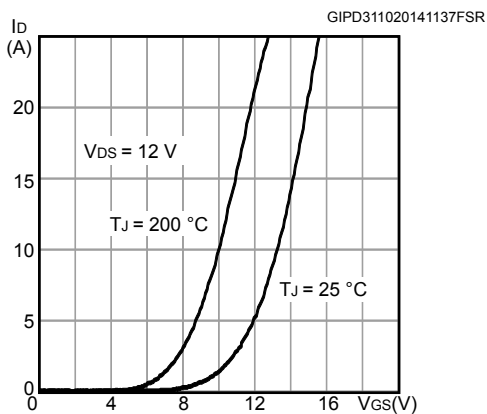
**Figure 3. Output characteristics @  $T_J = 25^\circ\text{C}$**



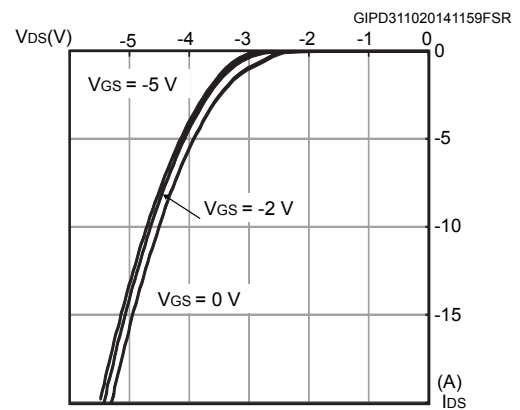
**Figure 4. Output characteristics @  $T_J = 200^\circ\text{C}$**



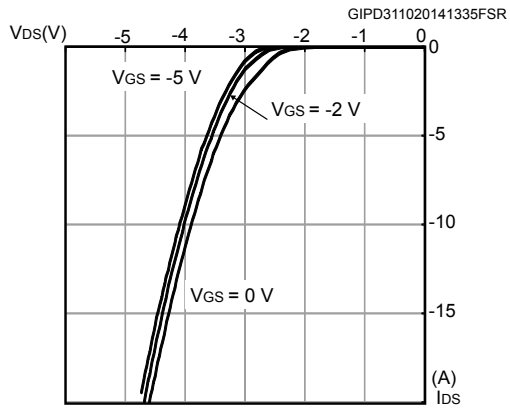
**Figure 5. Transfer characteristics**



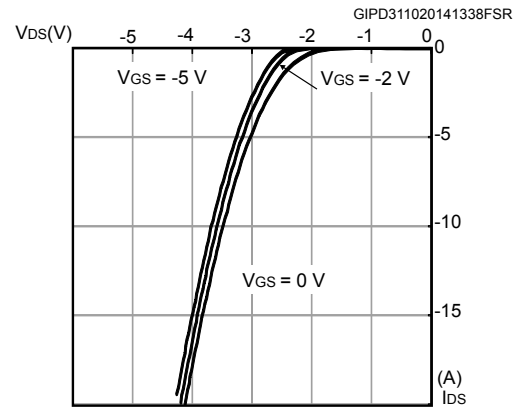
**Figure 6. Body diode characteristics @  $T_J = -50^\circ\text{C}$**



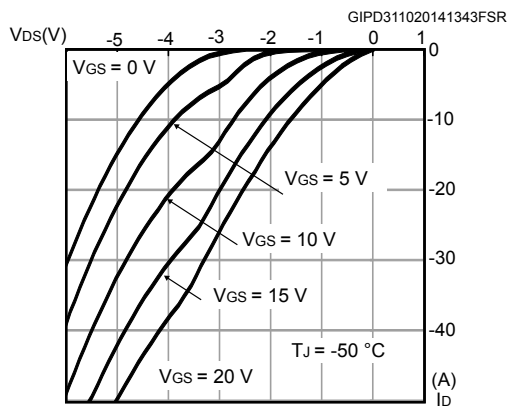
**Figure 7. Body diode characteristics @  $T_J = 25\text{ }^\circ\text{C}$**



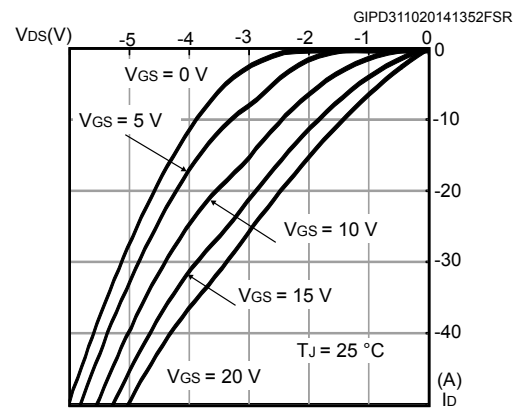
**Figure 8. Body diode characteristics @  $T_J = 150\text{ }^\circ\text{C}$**



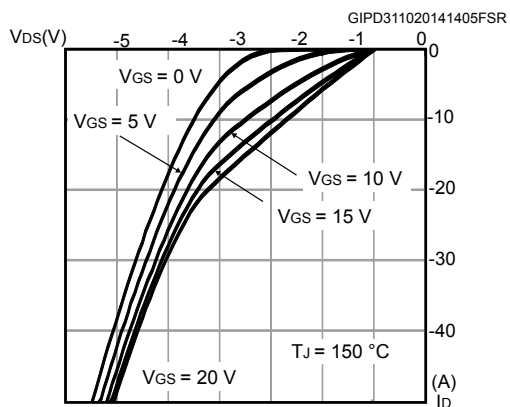
**Figure 9. 3<sup>rd</sup> quadrant characteristics @  $T_J = -50\text{ }^\circ\text{C}$**



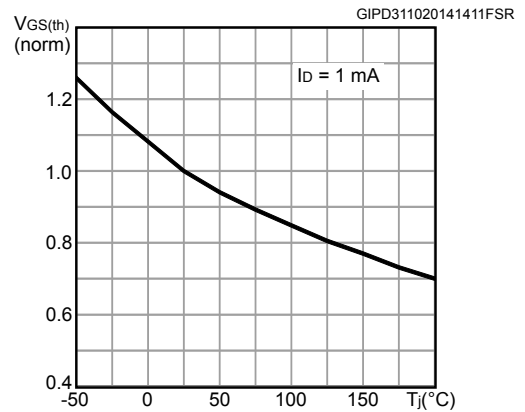
**Figure 10. 3<sup>rd</sup> quadrant characteristics @  $T_J = 25\text{ }^\circ\text{C}$**



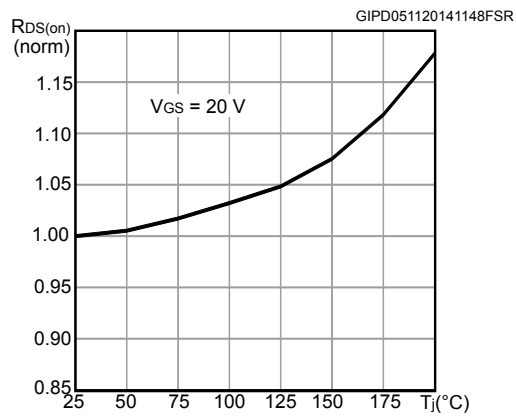
**Figure 11. 3<sup>rd</sup> quadrant characteristics @  $T_J = 150\text{ }^\circ\text{C}$**



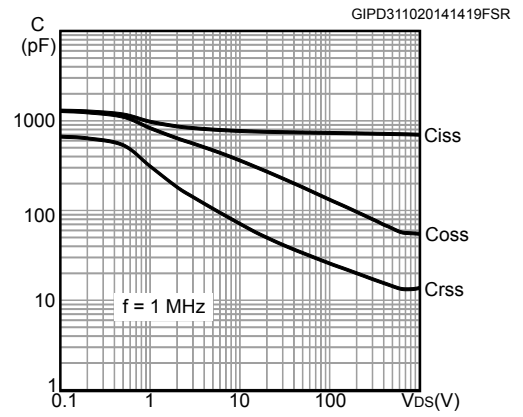
**Figure 12. Normalized gate threshold vs. temperature**



**Figure 13. Normalized  $R_{DS(on)}$  vs. temperature**

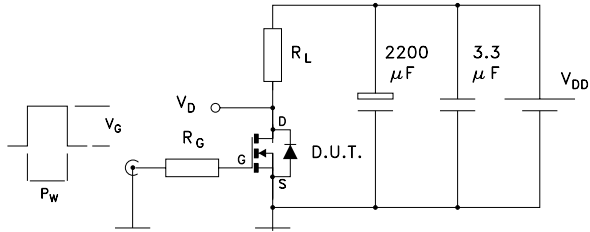


**Figure 14. Capacitances variation**



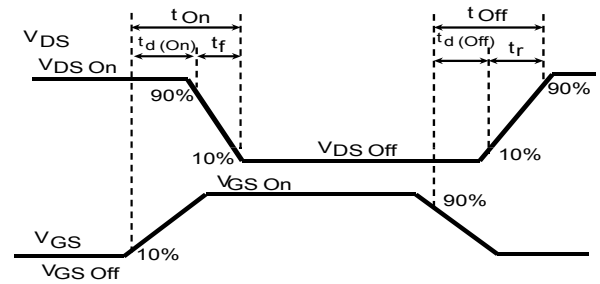
### 3 Test circuits

Figure 15. Switching test waveforms for transition times



GIPD101020141511FSR

Figure 16. Clamped inductive switching waveform



GIPD101020141502FSR



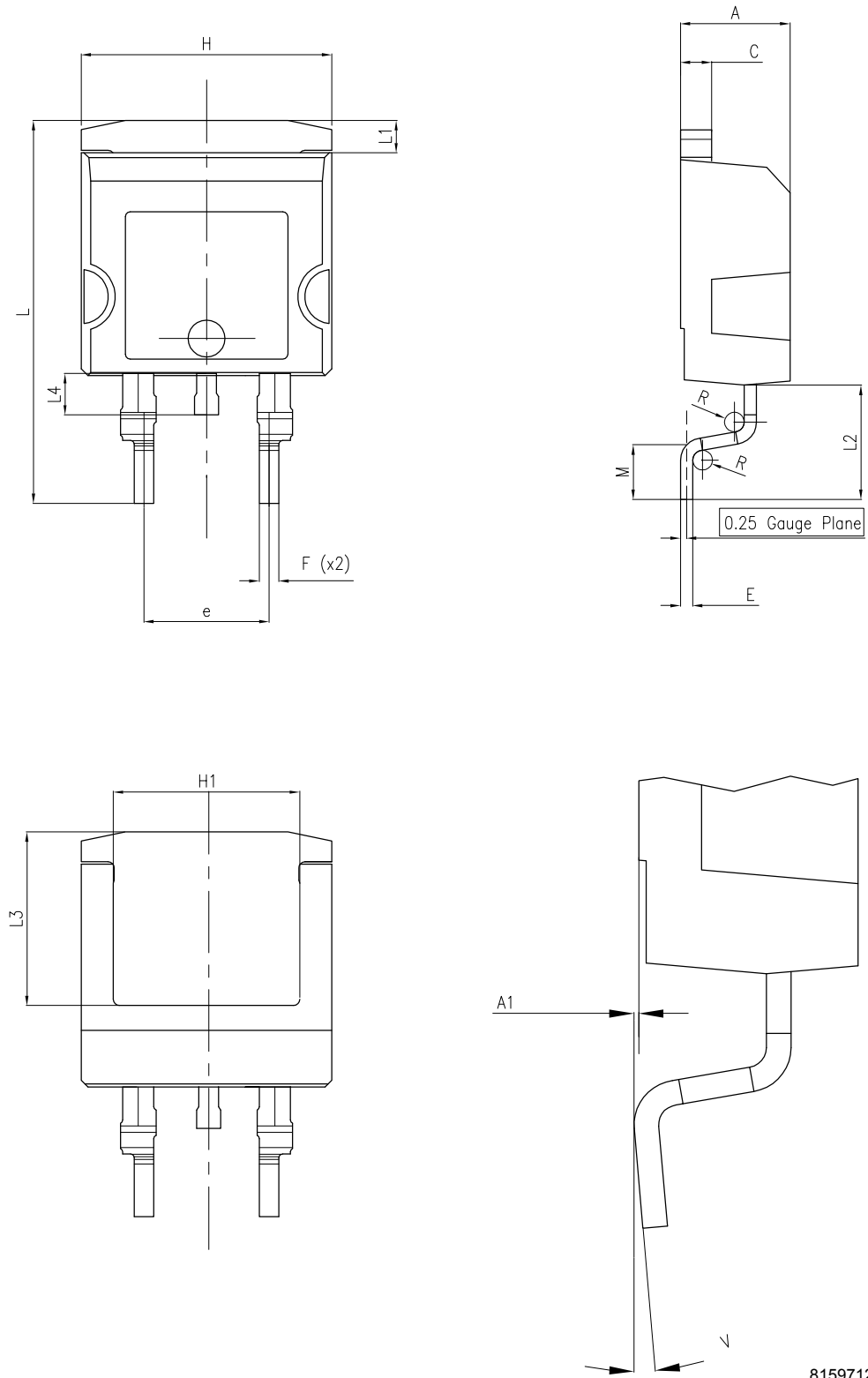
## 4 Package information

---

In order to meet environmental requirements, ST offers these devices in different grades of **ECOPACK** packages, depending on their level of environmental compliance. ECOPACK specifications, grade definitions and product status are available at: [www.st.com](http://www.st.com). ECOPACK is an ST trademark.

### 4.1 H<sup>2</sup>PAK-2 package information

Figure 17. H<sup>2</sup>PAK-2 package outline

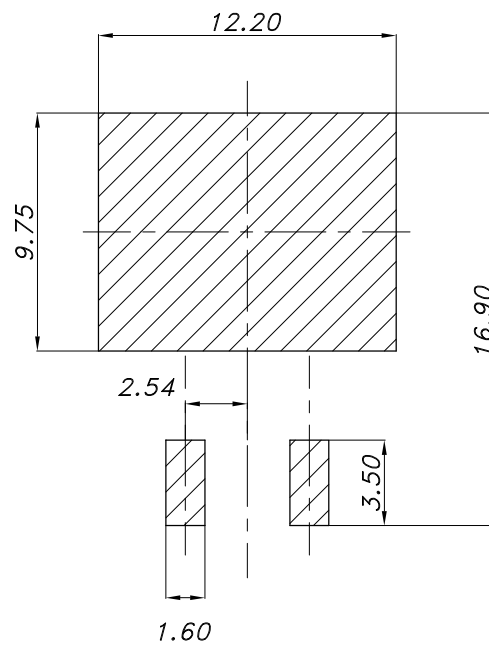


8159712\_8

**Table 8. H<sup>2</sup>PAK-2 package mechanical data**

Dim.	mm		
	Min.	Typ.	Max.
A	4.30		4.70
A1	0.03		0.20
C	1.17		1.37
e	4.98		5.18
E	0.50		0.90
F	0.78		0.85
H	10.00		10.40
H1	7.40		7.80
L	15.30		15.80
L1	1.27		1.40
L2	4.93		5.23
L3	6.85		7.25
L4	1.5		1.7
M	2.6		2.9
R	0.20		0.60
V	0°		8°

**Figure 18. H<sup>2</sup>PAK-2 recommended footprint**

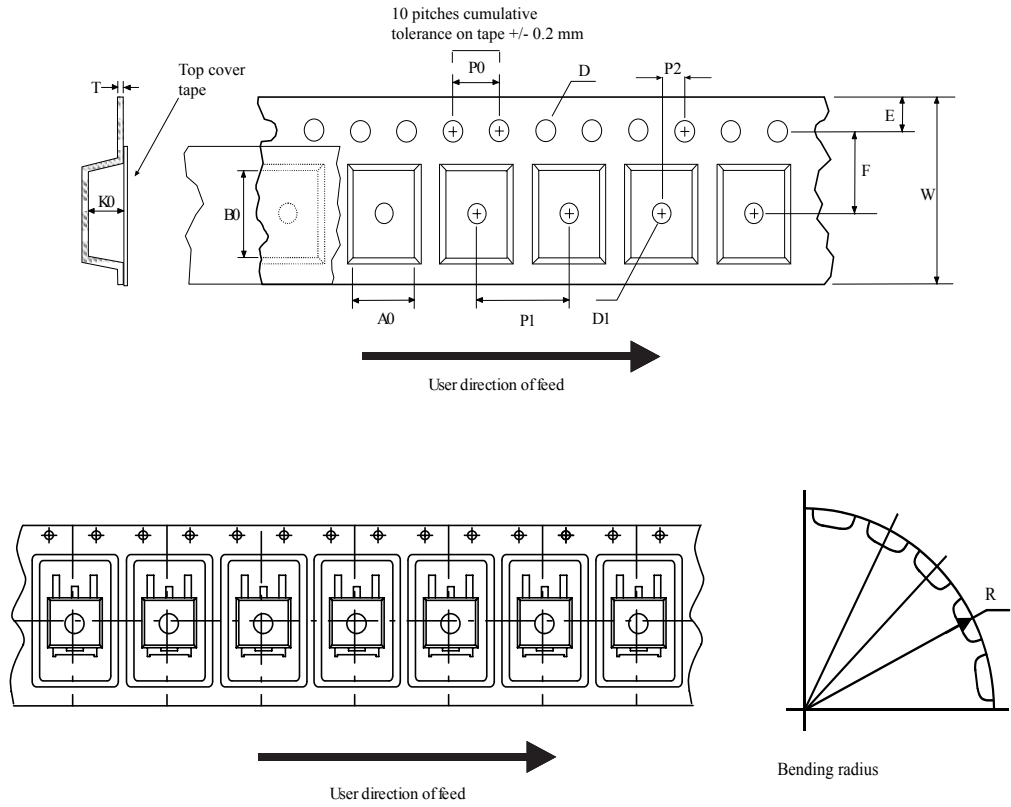


8159712\_8

*Note: Dimensions are in mm.*

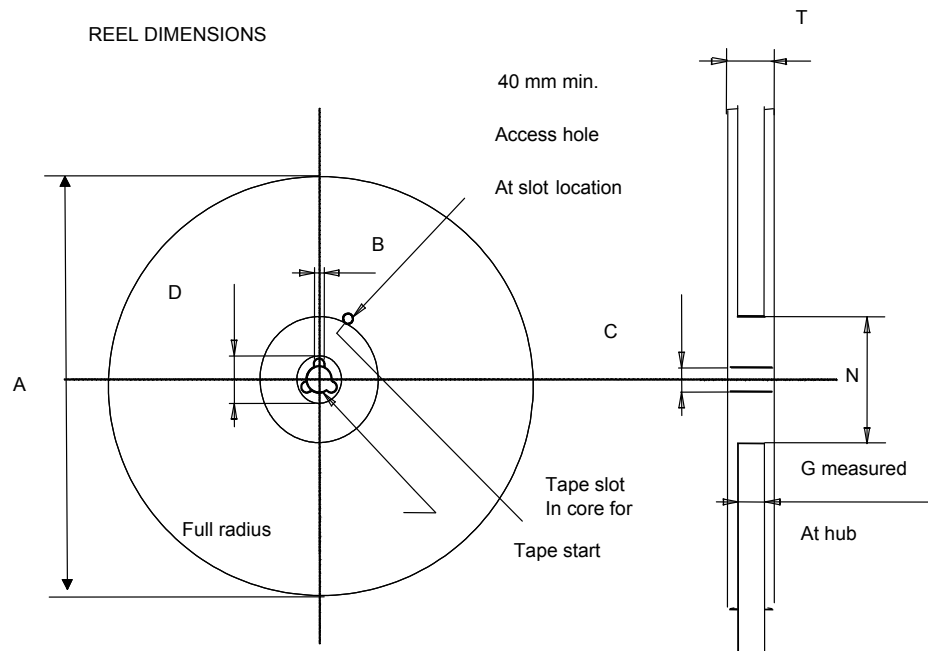
## 4.2 Packing information

Figure 19. Tape outline



AM08852v2

**Figure 20. Reel outline**



**Table 9. Tape and reel mechanical data**

Dim.	Tape		Dim.	Reel	
	mm			mm	
	Min.	Max.		Min.	Max.
A0	10.5	10.7	A		330
B0	15.7	15.9	B	1.5	
D	1.5	1.6	C	12.8	13.2
D1	1.59	1.61	D	20.2	
E	1.65	1.85	G	24.4	26.4
F	11.4	11.6	N	100	
K0	4.8	5.0	T		30.4
P0	3.9	4.1			
P1	11.9	12.1	Base quantity		1000
P2	1.9	2.1	Bulk quantity		1000
R	50				
T	0.25	0.35			
W	23.7	24.3			

## Revision history

**Table 10. Document revision history**

Date	Revision	Changes
11-Sep-2019	1	First release.
13-Dec-2019	2	Updated features in cover page, <a href="#">Table 1. Absolute maximum ratings</a> and <a href="#">On/off states</a> . Minor text changes.

## Contents

<b>1</b>	<b>Electrical ratings</b> .....	<b>2</b>
<b>2</b>	<b>Electrical characteristics</b> .....	<b>3</b>
<b>2.1</b>	Electrical characteristics (curves) .....	<b>5</b>
<b>3</b>	<b>Test circuits</b> .....	<b>8</b>
<b>4</b>	<b>Package information</b> .....	<b>9</b>
<b>4.1</b>	H <sup>2</sup> PAK-2 package information .....	<b>9</b>
<b>4.2</b>	Packing information .....	<b>11</b>
	<b>Revision history</b> .....	<b>14</b>

**IMPORTANT NOTICE – PLEASE READ CAREFULLY**

STMicroelectronics NV and its subsidiaries (“ST”) reserve the right to make changes, corrections, enhancements, modifications, and improvements to ST products and/or to this document at any time without notice. Purchasers should obtain the latest relevant information on ST products before placing orders. ST products are sold pursuant to ST’s terms and conditions of sale in place at the time of order acknowledgement.

Purchasers are solely responsible for the choice, selection, and use of ST products and ST assumes no liability for application assistance or the design of Purchasers’ products.

No license, express or implied, to any intellectual property right is granted by ST herein.

Resale of ST products with provisions different from the information set forth herein shall void any warranty granted by ST for such product.

ST and the ST logo are trademarks of ST. For additional information about ST trademarks, please refer to [www.st.com/trademarks](http://www.st.com/trademarks). All other product or service names are the property of their respective owners.

Information in this document supersedes and replaces information previously supplied in any prior versions of this document.

© 2019 STMicroelectronics – All rights reserved