

# LTE Industrial Router

# SmartFlex SR305

## USER MANUAL

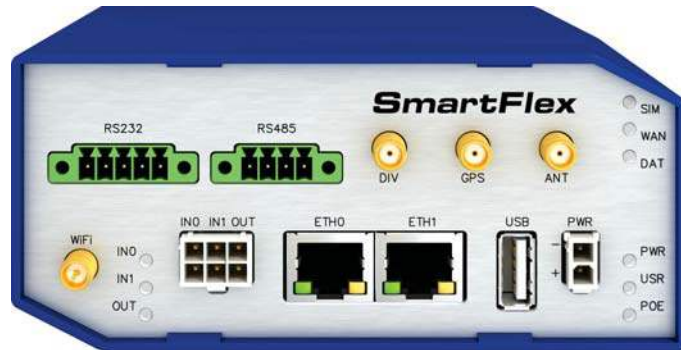
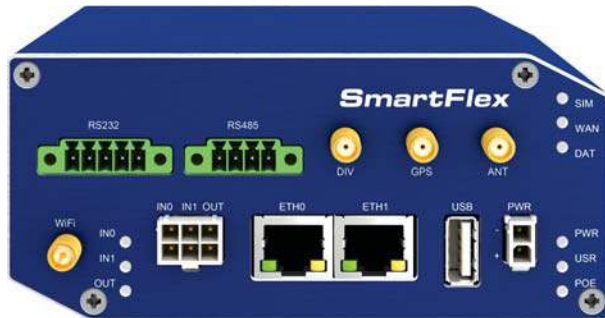

**B+B SMARTWORX**

Powered by

**ADVANTECH**

## **Advantech B+B SmartWorx – Americas**

**Advantech B+B SmartWorx**

707 Dayton Road  
Ottawa, IL 61350 USA

**Phone** +1 (815) 433-5100

**Fax** +1 (815) 433-5105

**Website**

[www.advantech-bb.com](http://www.advantech-bb.com)

## **Advantech B+B SmartWorx – Europe**

**Advantech B+B SmartWorx s.r.o.**

Sokolska 71  
562 04, Usti nad Orlici,  
Czech Republic

**Phone** +420 465 524 421

**Website**

[www.advantech-bb.com](http://www.advantech-bb.com)

© 2017 Advantech B+B SmartWorx s.r.o. No part of this publication may be reproduced or transmitted in any form or by any means, electronic or mechanical, including photography, recording, or any information storage and retrieval system without written consent. Information in this manual is subject to change without notice, and does not represent a commitment on the part of Advantech B+B SmartWorx.

Advantech B+B SmartWorx s.r.o. shall not be liable for incidental or consequential damages resulting from the furnishing, performance, or use of this manual.

All brand names used in this manual are the registered trademarks of their respective owners. The use of trademarks or other designations in this publication is for reference purposes only and does not constitute an endorsement by the trademark holder.

## Used symbols



*Danger* – Information regarding user safety or potential damage to the router.



*Attention* – Problems that can arise in specific situations.



*Information, notice* – Useful tips or information of special interest.

## GPL licence

Source codes under GPL licence are available free of charge by sending an email to:

[cellularsales@advantech-bb.com](mailto:cellularsales@advantech-bb.com).



# Contents

<b>1</b>	<b>Safety Instructions</b>	<b>2</b>
1.1	Hazardous Locations Installation Instructions . . . . .	2
1.2	Other Safety Instructions . . . . .	3
<b>2</b>	<b>Directives &amp; Statements</b>	<b>4</b>
2.1	Product Disposal Instructions . . . . .	4
2.2	FCC Compliance Statement . . . . .	4
<b>3</b>	<b>Router Description</b>	<b>6</b>
3.1	Usage of the Router . . . . .	7
<b>4</b>	<b>Contents of Package</b>	<b>10</b>
4.1	Recommended Accessories . . . . .	11
<b>5</b>	<b>Router Design</b>	<b>12</b>
5.1	Router versions . . . . .	12
5.2	Delivery identification . . . . .	14
5.3	Order codes . . . . .	15
5.4	Basic dimensions of the router box . . . . .	17
5.5	Mounting recommendations . . . . .	17
5.6	Removal of the DIN rail . . . . .	18
5.7	Description of the rear panel . . . . .	19
5.8	Description of the front panel . . . . .	19
5.8.1	Status indication . . . . .	20
5.8.2	Power connector PWR . . . . .	21
5.8.3	Antenna connector ANT, DIV, GPS and WiFi . . . . .	22
5.8.4	SIM card reader . . . . .	23
5.8.5	MicroSD card reader . . . . .	23
5.8.6	Ethernet Ports (ETH0 and ETH1) . . . . .	24
5.8.7	Power over Ethernet (PoE) . . . . .	25
5.8.8	USB Port . . . . .	27
5.8.9	I/O Port . . . . .	27
5.8.10	Reset . . . . .	30
5.9	Interfaces Description . . . . .	31
5.9.1	RS232-RS485/422 interface . . . . .	32
5.9.2	SWITCH interface . . . . .	35
5.9.3	RS232-RS485-ETH interface . . . . .	36
<b>6</b>	<b>First Use</b>	<b>39</b>

6.1	Connecting the router before first use . . . . .	39
6.2	Start . . . . .	40
6.3	Configuration . . . . .	40
6.3.1	Configuration by web browser . . . . .	40
<b>7</b>	<b>Technical Parameters</b>	<b>42</b>
7.1	Basic parameters . . . . .	42
7.2	Standards and regulations . . . . .	43
7.3	Type tests and environmental conditions . . . . .	44
7.4	Technical parameters of cellular module . . . . .	44
7.5	Technical parameters of GNSS . . . . .	45
7.6	Technical parameters of WiFi . . . . .	46
7.7	Technical parameters of I/O port . . . . .	46
7.8	Technical Parameters of Power over Ethernet (PoE) . . . . .	47
7.9	Other Technical Parameters . . . . .	47
<b>8</b>	<b>Recommended Literature</b>	<b>48</b>
<b>9</b>	<b>Troubleshooting</b>	<b>49</b>
9.1	FAQ . . . . .	49
<b>10</b>	<b>Customers Support</b>	<b>51</b>
10.1	Customer Support for NAM . . . . .	51
10.2	Customer Support for Europe . . . . .	51
10.3	Customer Support for Asia . . . . .	51

# List of Figures

1	Access to the Internet from LAN	7
2	Backed up access to the Internet	8
3	Using a VPN tunnel	8
4	Serial Gateway	9
5	Basic version (plastic)	12
6	Basic version with WiFi (plastic)	12
7	Basic version (metal)	12
8	Basic version with WiFi (metal)	12
9	Version SWITCH (plastic)	13
10	Version SWITCH with WiFi (plastic)	13
11	Version RS232-RS485 (plastic)	13
12	Ver. RS232-RS485 with WiFi (plastic)	13
13	Version RS232-RS485-ETH (plastic)	13
14	Version SWITCH (metal)	13
15	Version SWITCH with WiFi (metal)	13
16	Version RS232-RS485 (metal)	13
17	Ver. RS232-RS485 with WiFi (metal)	13
18	Version RS232-RS485-ETH (metal)	13
19	RS232-RS485-ETH & WiFi (plastic)	14
20	RS232-RS485-ETH & WiFi (metal)	14
21	Label examples	14
22	Basic dimensions of the router box	17
23	Default position of DIN holder	18
24	Removal of the DIN rail	18
25	SmartFlex front panel	19
26	Power connector	21
27	Connection of power supply	21
28	Connecting the antenna	22
29	SIM cards	23
30	MicroSD card	24
31	Ethernet connector	24
32	Connection of Ethernet cable	25
33	PoE PD usage	25
34	PoE PSE usage	26
35	USB connector	27
36	I/O connector	27
37	Binary inputs connection	28
38	Binary output connection	29
39	Router reset	30
40	Version with RS232-RS485/422 interface	32

41	RS232 connector . . . . .	32
42	RS485/422 connector . . . . .	33
43	Connection of jumpers . . . . .	34
44	Version with SWITCH board . . . . .	35
45	Version with RS232-RS485-ETH interface . . . . .	36
46	Ethernet connector . . . . .	36
47	RS485 connector . . . . .	37
48	RS232 connector . . . . .	37
49	Router connection . . . . .	39
50	Entering the IP address of the router . . . . .	40
51	Entering login information . . . . .	40
52	Router web interface . . . . .	41

# List of Tables

1	Router versions . . . . .	12
2	Delivery identification . . . . .	14
3	Order codes overview . . . . .	15
4	Power over Ethernet . . . . .	15
5	Type of router box . . . . .	16
6	Examples of order code . . . . .	16
7	Front panel description . . . . .	19
8	Status indication . . . . .	20
9	Connection of power connector . . . . .	21
10	Technical specifications of microSD card . . . . .	23
11	Connection of Ethernet connector . . . . .	24
12	Insulation strength of Ethernet ports . . . . .	25
13	Connection of USB connector . . . . .	27
14	Connection of I/O port . . . . .	27
15	Characteristics of inputs . . . . .	28
16	Description of router reset and restart . . . . .	30
17	Connection of RS232 connector . . . . .	32
18	Connection of RS485 connector . . . . .	33
19	Connection of RS422 connector . . . . .	33
20	Technical specification of RS232 and RS485 . . . . .	34
21	State indication of the SWITCH interface . . . . .	35
22	SWITCH interface parameters . . . . .	35
23	Connections of the Ethernet Connector . . . . .	36
24	Connections of Terminal Block Connector RS485 . . . . .	37
25	Connections of Terminal Block Connector RS232 . . . . .	37
26	State indication of the RS232-RS485-ETH interface . . . . .	38
27	Technical specification of RS232, RS485 and Ethernet . . . . .	38
28	Basic parameters . . . . .	42
29	Standards and regulations . . . . .	43
30	Type tests and environmental conditions . . . . .	44
31	Technical parameters of LTE module . . . . .	45
32	Technical parameters of GNSS . . . . .	45
33	Technical parameters of WiFi . . . . .	46
34	Characteristics of inputs . . . . .	46
35	PoE PD: parameters for opposite PSE . . . . .	47
36	PoE PSE parameters . . . . .	47
37	Other technical parameters . . . . .	47



# 1. Safety Instructions



*Please, observe the following instructions:*

## 1.1 Hazardous Locations Installation Instructions

These devices are open-type devices that are to be installed in an enclosure suitable for the environment and can only be accessed with the use of a tool or key.

This equipment is suitable for use in Class I, Division 2, Groups A, B, C, AND D OR non-hazardous locations only.

**WARNING** – EXPLOSION HAZARD – DO NOT DISCONNECT EQUIPMENT UNLESS POWER HAS BEEN REMOVED OR THE AREA IS KNOWN TO BE NON-HAZARDOUS.

**WARNING** – EXPLOSION HAZARD – SUBSTITUTION OF ANY COMPONENTS MAY IMPAIR SUITABILITY FOR CLASS I, DIVISION 2.

**WARNING** – EXPLOSION HAZARD – BATTERIES MUST ONLY BE CHANGED IN AN AREA FREE OF IGNITIBLE CONCENTRATION.

All antennas, antenna cables and wiring have not been evaluated as external wiring.

Cet équipement est convenable en Classe 1, Division 2, Groupes A, B, C, et D endroits dangereux OU endroits non dangereux seulement.

**AVERTISSEMENT** – RISQUE D'EXPLOSION – NE DÉCONNECTEZ PAS L'ÉQUIPEMENT, SAUF SI L'ALIMENTATION A ÉTÉ COUPÉE OU SI L'ENVIRONNEMENT EST CLASSÉ NON DANGEREUX.

**AVERTISSEMENT** – RISQUE D'EXPLOSION - SUBSTITUTION DE TOUTE COMPOSANTE RISQUERAIT LA QUALITÉ POUR CLASSE 1, DIVISION 2.

**AVERTISSEMENT** - RISQUE D'EXPLOSION - LES BATTERIES DOIVENT ÊTRE REMPLACÉES DANS UN ENDROIT EXEMPT DE CONCENTRATIONS INFLAMMABLES.

This equipment shall be mounted in an ATEX Zone 2 certified enclosure with a minimum ingress protection rating of at least IP54 (as defined in EN 60529) and used in an environment of not more than Pollution Degree 2 (as defined in EN 60664-1) when applied in Zone 2 environments. The enclosure must be accessible only by the use of a tool.

Provision shall be made to prevent the rated voltage from being exceeded by transient disturbances of more than 140 % of the rated voltage when applies in Zone 2 environments.

## 1.2 Other Safety Instructions

- The router must be used in compliance with all applicable international and national laws and in compliance with any special restrictions regulating the utilization of the router in prescribed applications and environments.
- To prevent possible injury and damage to appliances and to ensure compliance with all relevant provisions, use only the original accessories. Unauthorized modifications or the use of unapproved accessories may result in damage to the router and/or a breach of applicable regulations. Unauthorized modifications or use of unapproved accessories may void the warranty.
- The router can not be opened.
- Turn off the router and disconnect it from power supply before handling the SIM card.



- **Caution!** The SIM card could be swallowed by small children.
- Power supply must not exceed 60 V DC max.
- Do not expose the router to extreme ambient conditions. Protect the router against dust, moisture and high temperature.
- Only routers with appropriate certification and labelling should be used in locations where flammable and explosive materials are present, including gas stations, chemical plants, or locations in which explosives are used. We remind users of the duty to observe the restrictions concerning the utilization of radio devices at such places.
- Switch off the router when travelling by plane. Utilization of the router on a plane may endanger the operation of the plane or interfere with the mobile telephone network, and may be unlawful. Failure to observe these instructions may result in the suspension or cancellation of telephone services for the respective client and/or may result in legal sanctions.
- When using the router in close proximity to personal medical devices, such as cardiac pacemakers or hearing aids, you must proceed with heightened caution.
- The router may cause interference when used in close proximity to TV sets, radio receivers or personal computers.
- It is recommended that you create an appropriate copy or backup of all important settings that are stored in the memory of the device.

## 2. Directives and Statements

### 2.1 Product Disposal Instructions

The WEEE (Waste Electrical and Electronic Equipment: 2002/96/EC) directive was introduced to ensure that electrical/electronic products are recycled using the best available recovery techniques in order to minimize impact on the environment. This product contains high quality materials and components which can be recycled. At the end of its life this product **MUST NOT** be mixed with other commercial waste for disposal. Check the terms and conditions of your supplier for disposal information.

### 2.2 FCC Compliance Statement

This device complies with part 15 of the FCC Rules. Operation is subject to the following two conditions: (1) This device may not cause harmful interference, and (2) this device must accept any interference received, including interference that may cause undesired operation.

**Warning:** Changes or modifications to this unit not expressly approved by the party responsible for compliance could void the user's authority to operate the equipment.

This device complies with Industry Canada license-exempt RSS standard(s). Operation is subject to the following 2 conditions: (1) this device may not cause interference, and (2) this device must accept any interference, including interference that may cause undesired operation of the device.

This equipment has been tested and found to comply with the limits for a Class B digital device, pursuant to Part 15 of the FCC Rules. These limits are designed to provide reasonable protection against harmful interference in a residential installation. This equipment generates, uses, and can radiate radio frequency energy and, if not installed and used in accordance with the instructions, may cause harmful interference to radio communications. However, there is no guarantee that interference will not occur in a particular installation. If this equipment does cause harmful interference to radio or television reception, which can be determined by turning the equipment off and on, the user is encouraged to try to correct the interference by one or more of the following measures:

- Reorient or relocate the receiving antenna.
- Increase the separation between the equipment and receiver.
- Connect the equipment into an outlet on a circuit different from that to which the receiver is connected.
- Consult the dealer or an experienced radio/TV technician for help.

**Important:** Changes or modifications to this product not authorized by Advantech B+B SmartWorx could void the electromagnetic compatibility (EMC) and wireless compliance and negate your authority to operate the product. This product has demonstrated EMC compliance under conditions that included the use of compliant peripheral devices and shielded cables between system components. It is important that you use compliant peripheral devices and shielded cables between system components to reduce the possibility of causing interference to radios, televisions, and other electronic devices.

## 3. Router Description

SmartFlex SR305 is an industrial cellular router intended for the North American market (NAM). This router is an ideal device for wireless communication in mobile networks that make use of LTE, HSPA+, UMTS, EDGE or GPRS technology. Due to the high speed of data transfer (up to 100 Mbps download and up to 50 Mbps upload) this router is an ideal solution for specialized M2M devices and IoT as well as for wireless connection of traffic and security camera systems, individual computers, LAN networks, automatic teller machines (ATMs) and other self-service terminals.

The standard configuration includes two Ethernet 10/100 ports, one USB 2.0 Host port, two binary inputs and one output (I/O connector). The device also has two readers for 3 V and 1.8 V SIM cards, which are located on the rear panel of the router. The router also includes a microSD card port that supports up to 64 GB card storage (32 GB in the case of SDHC cards). The router can be equipped with a WiFi module, but this must be part of the initial configuration – it cannot be added to the router at later date.

The router can be equipped with PoE PD (Power over Ethernet – Powered Device), which allows the router to be powered via Ethernet. It can also be equipped with PoE PSE (Power over Ethernet – Power Source Equipment), which enables the router to power other devices via Ethernet. The SmartFlex can also be configured with a wide variety of port options. Options include SWITCH – three switched Ethernet ports; RS232-RS485/422 – combination of serial interfaces; RS232-RS485-ETH – combination of serial interfaces and an Ethernet port with higher insulation. The router can be supplied in either plastic or metal casing, depending on customer requirements.

The router can be configured using a password-protected Web interface. The Web interface provides detailed statistics about the router's activities, signal strength, detailed system logs etc. The router supports the creation of VPN tunnels using IPSec, OpenVPN and L2TP to ensure safe communication. DHCP, NAT, NAT-T, DynDNS, NTP, VRRP, control by SMS, primary connection backups and many other functions are also supported.

The router performs diagnostic functions including automatic monitoring of the PPP connection, automatic restart in case of connection losses, and a hardware watchdog that monitors the router status. It is possible to insert Linux scripts in order to perform various actions. It is also possible to create up to four different configurations for the same router. These configurations can be switched between at any via the Web interface, SMS or binary input status. The router can automatically upgrade its configuration and firmware from a central server, allowing for the mass reconfiguration of numerous routers at the same time.

The router also supports additional software such as R-SeeNet for permanent traffic monitoring of routers.



### Examples of possible applications

- mobile office
- fleet management
- security systems
- telematic
- telemetric
- remote monitoring
- vending and dispatcher machines

## 3.1 Usage of the Router

The router is primarily intended for these four basic situations:

### I. Access to the Internet from LAN

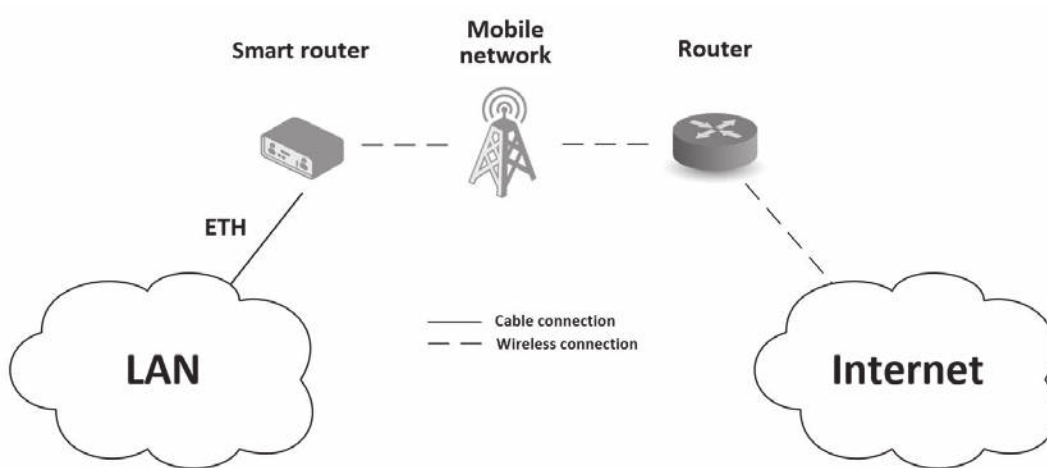

Figure 1: Access to the Internet from LAN

**II. Backed up access to the Internet (from LAN)**

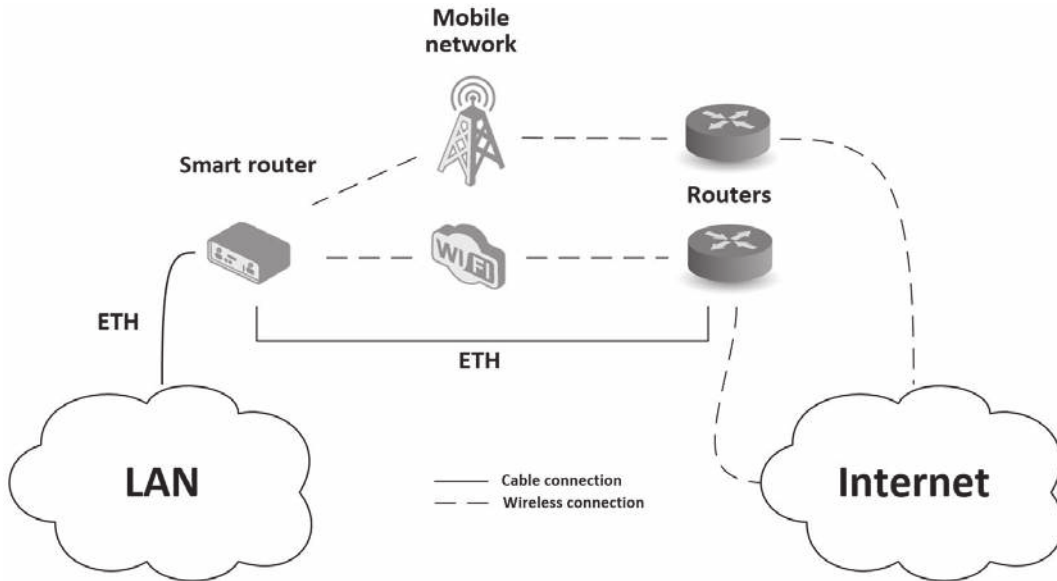

Figure 2: Backed up access to the Internet

**III. Secure networks interconnection or using VPN**

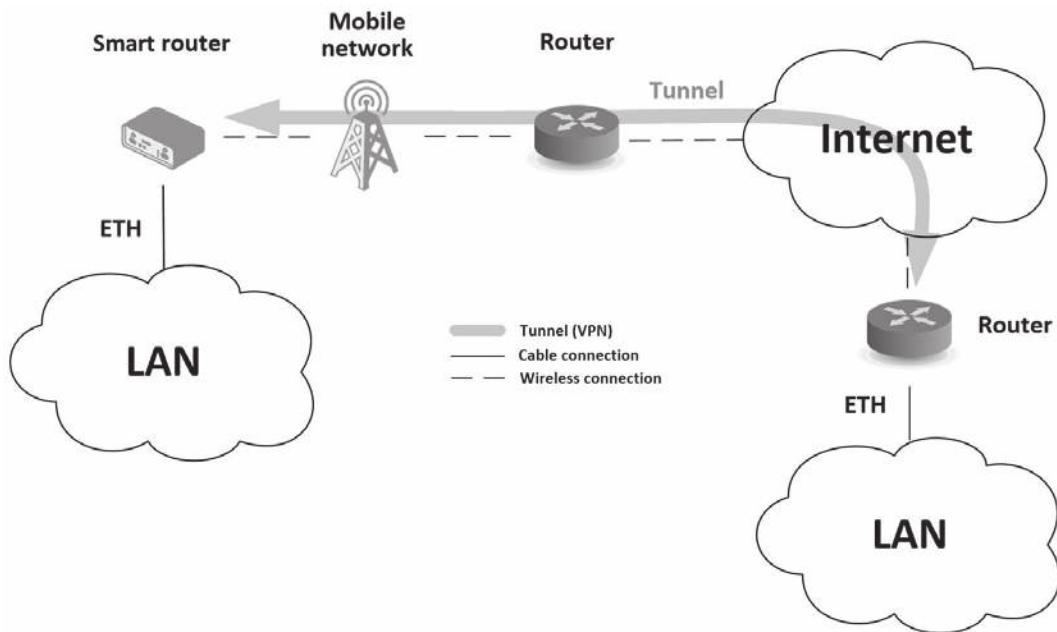

Figure 3: Using a VPN tunnel

#### IV. Serial Gateway

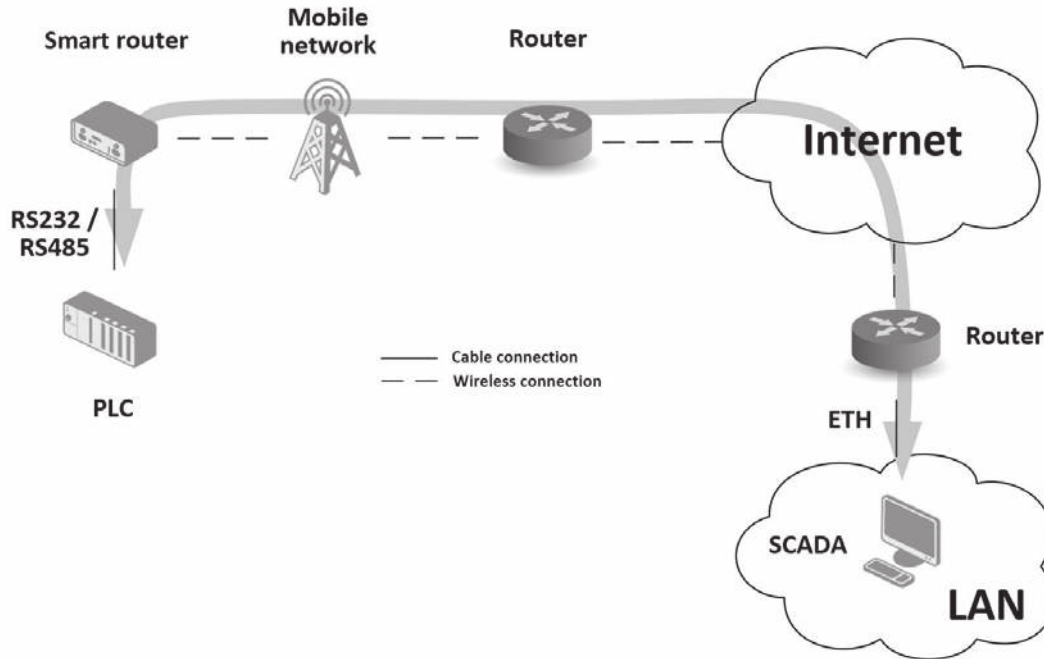

Figure 4: Serial Gateway



## 4. Contents of Package



The basic delivered router set includes:

- router,
- twin cable with power connector (BB-KN-v3-MO2-3),
- extra 6-pin I/O connector (+ 8 pins<sup>1</sup>),
- 4-pin and 5-pin terminal block for RS485 and RS232 (**only for version with interface RS232-RS485/422**),
- 3-pin and 4-pin terminal block for RS485 and RS232 (**only for version with interface RS232-RS485-ETH**),
- DIN rail clip,
- Start guide for SmartFlex routers.

---

<sup>1</sup>These pins are designed for cables with diameters from 0.2 to 0.8 mm<sup>2</sup>

## 4.1 Recommended Accessories

The following list contains recommended accessories. **These accessories are not included in the basic package!**

- LTE antennas:
  - Terminal antenna Taoglas TG.30.8113, order code: BB-TG.30.8113
- WiFi antenna:
  - Sectron, order code: BB-AW-A2458G-FSRPK
- Power supplies:
  - Regular power supply with universal set of power cords, order code: BB-RPS-v3-MO2-M
  - Power supply for use with PoE PSE versions with US power cord, order codes: BB-RPS-v3-PSE and BB-PWRCORD-US

# 5. Router Design

## 5.1 Router versions

The SmartFlex SR305 router is supplied in the following versions (see table below). All versions are available in plastic or metal casing according to customer requirements. All versions are available with PoE PD (Power over Ethernet – powered device) allowing the router to be powered using both ETH0 and ETH1 interfaces, or with PoE PSE (power source equipment) allowing the router to power other devices.

Router versions	SIM	BIN	BOUT	USB	SD	ETH	WiFi	232	485	SM IP
Basic version	2x	2x	1x	1x	1x	2x				
Basic version with WiFi	2x	2x	1x	1x	1x	2x	1x			
Version with SWITCH board	2x	2x	1x	1x	1x	5x				
Version with SWITCH board & WiFi	2x	2x	1x	1x	1x	5x	1x			
Version with RS232-RS485/422 board	2x	2x	1x	1x	1x	2x		1x	1x	
Version with RS232-RS485/422 & WiFi	2x	2x	1x	1x	1x	2x	1x	1x	1x	
Version with RS232-RS485-ETH board	2x	2x	1x	1x	1x	3x		1x	1x	
Version with RS232-RS485-ETH & WiFi	2x	2x	1x	1x	1x	3x	1x	1x	1x	

Table 1: Router versions



Figure 5: Basic version (plastic)



Figure 7: Basic version (metal)



Figure 6: Basic version with WiFi (plastic)



Figure 8: Basic version with WiFi (metal)



Figure 9: Version SWITCH (plastic)



Figure 14: Version SWITCH (metal)



Figure 10: Version SWITCH with WiFi (plastic)



Figure 15: Version SWITCH with WiFi (metal)



Figure 11: Version RS232-RS485 (plastic)



Figure 16: Version RS232-RS485 (metal)



Figure 12: Ver. RS232-RS485 with WiFi (plastic)



Figure 17: Ver. RS232-RS485 with WiFi (metal)



Figure 13: Version RS232-RS485-ETH (plastic)



Figure 18: Version RS232-RS485-ETH (metal)



Figure 19: RS232-RS485-ETH & WiFi (plastic)



Figure 20: RS232-RS485-ETH & WiFi (metal)

## 5.2 Delivery identification

Trade name	Product name	Description
SmartFlex SR305	SmartFlex	Router in a plastic or metal box

Table 2: Delivery identification



Figure 21: Label examples

### 5.3 Order codes

The table below shows an overview of order codes.

Product Name	Order code	Features – interfaces
SR305	BB-SR3050x0y0*	LTE module for NAM, 2x ETH, 1x USB, 2x BI, 1x BO, 1x microSD reader, 2x SIM reader
SR305	BB-SR3051x0y0*	LTE module for NAM, 2x ETH, 1x USB, 2x BI, 1x BO, 1x microSD reader, 2x SIM reader, WiFi
SR305	BB-SR3050x1y0*	LTE module for NAM, 5x ETH, 1x USB, 2x BI, 1x BO, 1x microSD reader, 2x SIM reader
SR305	BB-SR3051x1y0*	LTE module for NAM, 5x ETH, 1x USB, 2x BI, 1x BO, 1x microSD reader, 2x SIM reader, WiFi
SR305	BB-SR3050x3y0*	LTE module for NAM, 2x ETH, 1x USB, 2x BI, 1x BO, 1x microSD reader, 2x SIM reader, RS232, RS485
SR305	BB-SR3051x3y0*	LTE module for NAM, 2x ETH, 1x USB, 2x BI, 1x BO, 1x microSD reader, 2x SIM reader, WiFi, RS232, RS485
SR305	BB-SR3050x4y0*	LTE module for NAM, 3x ETH, 1x USB, 2x BI, 1x BO, 1x microSD reader, 2x SIM reader, RS232, RS485
SR305	BB-SR3051x4y0*	LTE module for NAM, 3x ETH, 1x USB, 2x BI, 1x BO, 1x microSD reader, 2x SIM reader, WiFi, RS232, RS485

Table 3: Order codes overview



\* Replace the letters "x" and "y" with the values from the following tables:

#### Letter "x" – Power over Ethernet (PoE)

Power over Ethernet (PoE)	Number "x" in code
Version without PoE	0
PoE PSE – Power Source Equipment – powers other devices	8
PoE PD – Powered Device – can be powered via Ethernet	9

Table 4: Power over Ethernet

**Letter "y" – type of the router box**

Type of box	Number "y" in code
Plastic	1
Metal	2

Table 5: Type of router box

Examples of complete order codes:

Order code	Features – interfaces	Box	Power supply
BB-SR30500010	LTE module for NAM, 2x ETH, 1x USB, 2x BI, 1x BO, 1x microSD reader, 2x SIM reader	plastic	None
BB-SR30510120	LTE module for NAM, 5x ETH, 1x USB, 2x BI, 1x BO, 1x microSD reader, 2x SIM reader, WiFi	metal	None

Table 6: Examples of order code

## 5.4 Basic dimensions of the router box

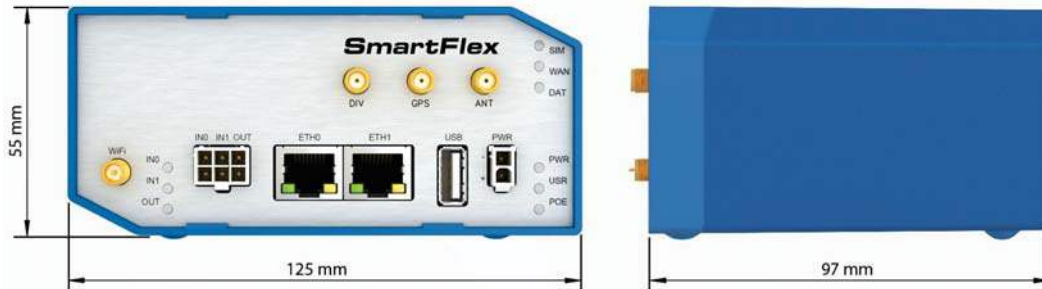

Figure 22: Basic dimensions of the router box

## 5.5 Mounting recommendations

- It is possible to place the router on a flat surface,
- DIN rail EN 60715 with the included plastic or metal clip.

For most applications with a built-in router within a switchboard it is possible to recognize two kinds of environments:

- A non-public, industry environment of low voltage with high interference,
- A public environment of low voltage and without high interference.

For both of these environments it is possible to mount router to a switchboard, after which there is no need to have examination immunity or issues in connection with EMC according to EN 61439-1:2011.



**Attention:** If the negative pole of the router is grounded, there is no protection against reversed polarity!



In compliance with the EN 61439-1:2011 specification it is necessary to observe the following assembly instructions for a router attached to a switchboard:

- For whip antennas it is recommended to observe a minimum distance of 6 cm from cables and metal surfaces on every side in order to avoid interference. When using an external antenna separate from the switchboard it is necessary to fit a lightning conductor.
- When mounting a router on sheet-steel we recommend using a "cable" antenna.
- For all cables we recommend to bind the bunch, and for this we recommend:



- The length of the bunch (combination of power supply and data cables) should be a maximum 1.5 m. If the length of data cables exceeds 1.5 m or if the cable is leading towards the switchboard, we recommend installing surge protectors.
- Data cables must not have a reticular tension of  $\sim 230$  V/50 Hz or  $\sim 120$  V/60 Hz.
- Sufficient space must be left between individual connectors for the handling of cables,
- To ensure correct functioning of the router we recommend the use of an earth-bonding distribution frame for the grounding of the power supply of the router, data cables and antenna within the switchboard.

### 5.6 Removal of the DIN rail

The DIN holder is suitable for a DIN rail according to EN 60715 standard only. The default position of of plastic or metal holder, which is used for mounting the router on a DIN rail, is shown in the following figure:

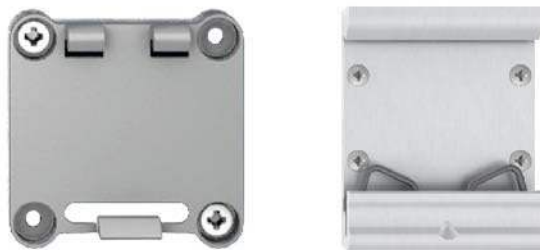

Figure 23: Default position of DIN holder

In order to remove the DIN rail it is necessary to lightly push the router upward so that the top part of the DIN holder hitched to the DIN rail comes out of this rail, then fold the top of the router away from the DIN rail.

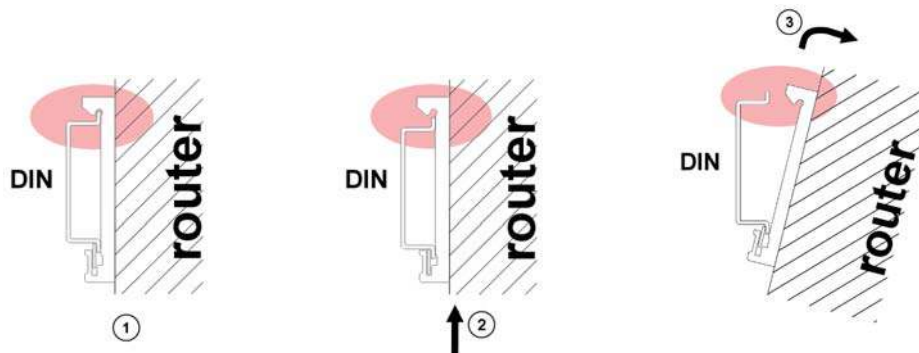

Figure 24: Removal of the DIN rail

### 5.7 Description of the rear panel

The rear panel contains two holders for SIM cards (*SIM1* and *SIM2*), a holder for microSD card (*SD*) and an *RST* button used to restore the default configuration and reboot the router.

### 5.8 Description of the front panel

On the front panel is the following:

Caption	Connector	Description
PWR	2-pin	Connector for the power supply
ETH0	RJ45	Connector for connection into the computer network, PoE (only for PoE PSE or PoE PD versions)
ETH1	RJ45	Connector for connection into the computer network, PoE (only for PoE PSE or PoE PD versions)
ANT	SMA	Connector for main antenna
DIV	SMA	Connector for diversity antenna
GPS	SMA	Connector for GPS antenna
WiFi	R-SMA	Connector for WiFi antenna ( <b>only for versions with WiFi module!</b> )
USB	USB-A 2.0 Host	Connector for connection of USB devices to the router. Supports devices with PL-2303 and FTDI USB/RS232 converters.
I/O	6-pin	Connector for connection of the binary inputs and output

Table 7: Front panel description

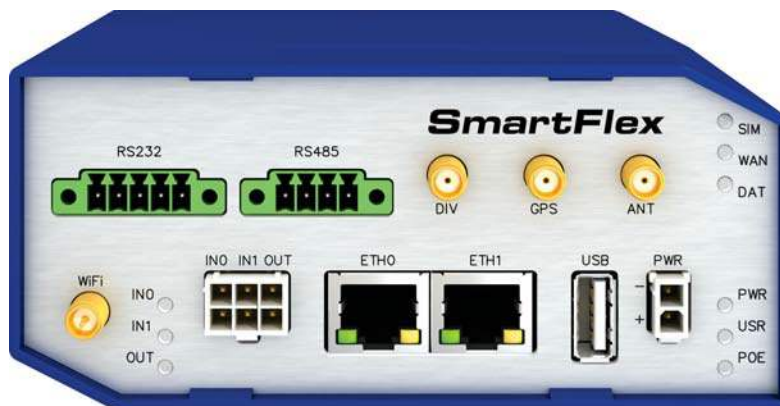

Figure 25: SmartFlex front panel

### 5.8.1 Status indication

There are nine LED indicators on the front panel to provide router status information. Each ETH port has two additional LEDs that provide information about the port status.

Caption	Color	State	Description
PWR	Green	Blinking On Fast blinking	Router is ready Starting of the router Updating firmware
USR	Yellow	—	Function of this LED diode can be selected by user
POE	Yellow	On Blinking	PSE: insufficient power supply via PWR connector PSE: overload (device takes much power)/short circuit*
	Green	On  Blinking Off	PoE PD versions: The voltage present in ETH port PSE: correct power supply via PWR connector PSE: The device is powered via one of the ETH ports PD: The voltage not present in ETH port PSE: disabled (not enabled on any of ETH ports)
SIM	Green	On (Green color)	The first SIM card is active
	Yellow	On (Yellow color)	The second SIM card is active
WAN	Yellow	LED goes out 1x per one sec.	Signal strength is from -50 dBm to -69 dBm
		LED goes out 1x per two sec.	Signal strength is from -70 dBm to -89 dBm or difference between neighbouring cells is exactly 3 dBm
		LED goes out 1x per five sec.	Signal strength is from -90 dBm to -113 dBm or difference between neighbouring cells is smaller than 3 dBm
DAT	Red	Blinking	Communication in progress on radio channel
IN0	Green	On	Binary input no. 0 is active
IN1	Green	On	Binary input no. 1 is active
OUT	Yellow	On	Binary output is active
ETH0	Green	On	Selected 100 Mbps
ETH1		Off	Selected 10 Mbps
ETH0	Yellow	On	The network cable is connected
ETH1		Blinking	Data transmission
ETH1		Off	The network cable is not connected

Table 8: Status indication

\* Additionally it can indicate a device without PoE support connected on the other side of the cable. In this case the indication is caused by low impedance (lower than 500 Ω) of the device without PoE support. This can be solved by disabling the PoE PSE feature on the relevant ETH port in the router's Web interface, see *Configuration manual* [2].



The status indication of the WAN LED is updated every 10 seconds.

### 5.8.2 Power connector PWR

Panel socket 2-pin.

Pin number	Signal mark	Description
1	GND(-)	Negative pole of DC supply voltage
2	VCC(+)	Positive pole of DC supply voltage (+10 to +60 V DC)

Table 9: Connection of power connector

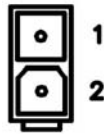

Figure 26: Power connector



Unit has to be supplied by a power supply specified as a Limited Power Source (LPS) according to clause 2.5 of IEC/UL 60950-1 or CEC/NEC Class 2 source of supply as defined in the Canadian Electrical Code, CSA C22.1 and National Electrical Code, ANSI/NFPA 70. If the power supply/cable provided with device is not used, always use the cables with minimum wire size (nominal cross section) 0.5 square mm for power supply.

The power supply for the router must be between +10 V to +60 V DC supply. Protection against reversed polarity without signaling is built into the router. **Note:** The protection against reversed polarity is lost if the negative pole is grounded!

The router can be put into low power mode using a special command `lpm`. It can then be awakened, for example, by an activity on binary input or using an internal timer.



Circuit example:

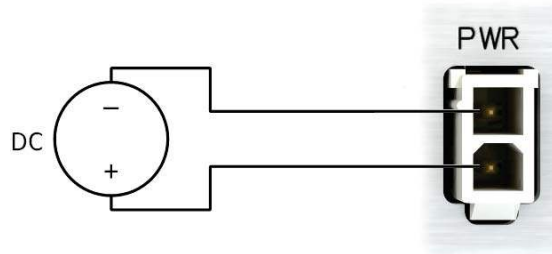

Figure 27: Connection of power supply



**Note for PoE:** See Chapter 5.8.7 for information on how PoE versions of the router impact the power supply usage. The power supply for a PoE PSE router has to meet other specific requirements.

### 5.8.3 Antenna connector ANT, DIV, GPS and WiFi

The main, diversity and GPS antennas are connected to the router using the SMA connector on the front panel. There is also an R-SMA antenna connector available, through which an additional antenna can be connected, if the router is equipped with a WiFi module.

The *ANT* connector is used to connect the main antenna to the router. To connect the diversity antenna, the second antenna connector *DIV* is used. The third connector (*GPS*) is intended for a GPS antenna (the router supports active GPS antennas). An R-SMA connector named *WiFi* is designed for the connection of a WiFi antenna (available only for versions with a WiFi module).



The router can not operate without a main antenna connected through the port marked as *ANT*!



An SMA connector is used for the connection of the antenna. The antenna is connected by screwing this antenna to the SMA connector on the front panel of the router (see figure below).

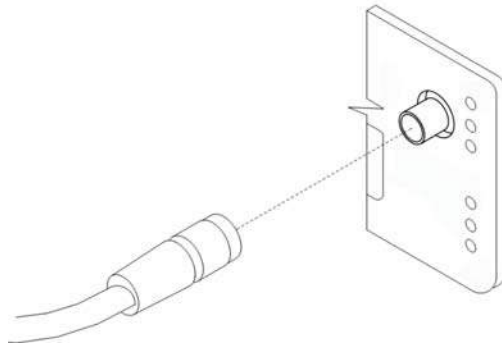

Figure 28: Connecting the antenna



A diversity antenna improves the radio capability of the router at low signal strength.

### 5.8.4 SIM card reader

Two SIM card readers for 3 V and 1.8 V SIM cards are located on the rear panel of the router. In order for the router to function, it is necessary to insert an activated SIM card with an unblocked PIN code. The SIM cards may have different adjusted APNs (Access Point Names).

#### Changing the SIM card:

- Always disconnect the router from power supply before handling the SIM card!
- Using a plastic opening tool, or your fingernail, press the SIM card slightly into its slot until you hear a click.
- After hearing this click, release the card and it will pop out of its slot.
- Remove the SIM card and push any other SIM card into the slot until it clicks into place.



Figure 29: SIM cards

### 5.8.5 MicroSD card reader

The microSD card reader is located on the rear panel of the router (the third slot). This card reader allows the router to operate with microSD memory cards. The technical specifications are stated in the table below.

Technical specifications of microSD card		
Supported technologies		SDHC, SDXC
Supported capacity	SDHC	up to 32 GB
	SDXC	from 32 GB to 64 GB
Supported microSD card filesystems		vfat, ext2, ext3, ext4

Table 10: Technical specifications of microSD card

**Changing the microSD card:**



- Using the flat end of a spudger, or your fingernail, press the microSD card slightly into its slot until you hear a click.
- After hearing this click, release the card and it will pop out of its slot.
- Remove the microSD card and push any other microSD card into the slot until it clicks into place.



Figure 30: MicroSD card

**5.8.6 Ethernet Ports (ETH0 and ETH1)**

Panel socket RJ45.

Pin	Signal mark	Description	Data flow direction
1	TXD+	Transmit Data – positive pole	Input/Output
2	TXD-	Transmit Data – negative pole	Input/Output
3	RXD+	Receive Data – positive pole	Input/Output
4	DC+	PoE power + (if it's equipped by PoE)	
5	DC+	PoE power + (if it's equipped by PoE)	
6	RXD-	Receive Data – negative pole	Input/Output
7	DC-	PoE power - (if it's equipped by PoE)	
8	DC-	PoE power - (if it's equipped by PoE)	

Table 11: Connection of Ethernet connector

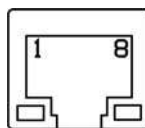

Figure 31: Ethernet connector

The crossover UTP cable (Ethernet cable) plugs into the RJ45 connector labeled as ETH0 or ETH1 (see figure below).

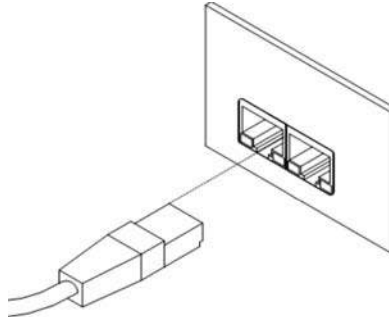

Figure 32: Connection of Ethernet cable



The insulation strength of Ethernet ports from each other and from the rest of the router (grounding) is dependent on the router version:

Router Version	Insul. Strength from Router	Insul. Strength between Ports
Without PoE	1.5 kV	1.5 kV
PoE PD	1.5 kV	none
PoE PSE	none	none

Table 12: Insulation strength of Ethernet ports

### 5.8.7 Power over Ethernet (PoE)

On the router models with PoE, the PoE+ standard IEEE 802.3at-2009 and PoE standard IEEE 802.3af-2003 are supported in both Ethernet ports (ETH0, ETH1). The PoE PD version allows the router to be powered over the Ethernet by another PoE PSE device. The PoE PSE version also allows the router to power other devices over the Ethernet.

#### PoE PD

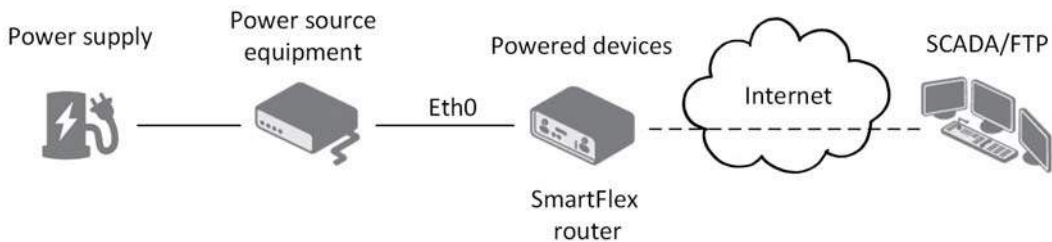

Figure 33: PoE PD usage



The PoE PD parameters can be found in Chapter 7.8. The POE LED on the front panel of the router lights up green when voltage is present in an Ethernet port so the user knows the router can be PoE powered. You can still power the router with this connector even if the router is powered with PoE (in PoE PD version), but the input voltage must be higher than 15 V DC. If the input voltage is lower than 15 V DC and the PoE voltage is present (PoE LED green on), the router will still be powered from the Ethernet connector via PoE.

**Note:** You can not power the router via the ETH2 ports on the SWITCH router version. The PoE PD is available on the ETH0 and ETH1 ports only.

### PoE PSE

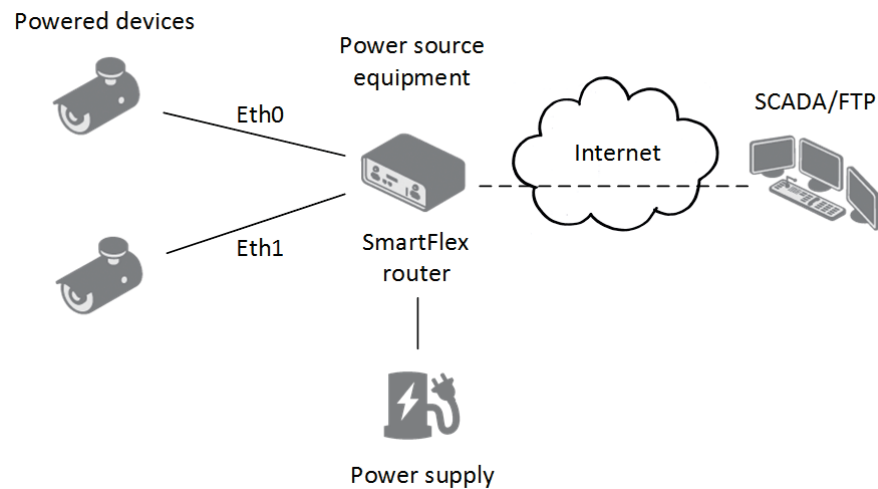

Figure 34: PoE PSE usage



The power supply used with the PoE PSE router has to provide voltage from 44 to 57 V DC and the output power has to be at least 65 W for full PoE+ use (Class 4) in both Ethernet ports (ETH0 and ETH1).

The PoE PSE parameters can be found in Chapter 7.8. The PoE state is indicated by the POE LED on the front panel of the router, see Chap. 5.8.1. When sufficient voltage (44 to 57 V) and power is available is indicated by the green light. A yellow POE LED indicates insufficient power or voltage through the PWR connector. When a device is being powered from the router, the POE LED is will show blinking green. Yellow blinking is shown for an overload (the powered device is using too much power) or a short circuit (incorrect wiring of the cable or of the device without PoE support).

You can enable or disable the PoE PSE feature separately on the ETH0 and ETH1 ports via the Web interface of the router. This can be found in the LAN configuration pages (*Primary* for ETH0, *Secondary* for ETH1). When PoE PSE is enabled, you can find the current, voltage, power and power class information on the *General* page of the router's Web interface. See the *Configuration manual* [2]. Via SSH or in scripts you can use the Shell command `pse`.

### 5.8.8 USB Port

Panel socket USB-A.

Pin	Signal mark	Description	Data flow direction
1	+5 V	Positive pole of 5 V DC supply voltage, 0.5 A	
2	USB data -	USB data signal – negative pole	Input/Output
3	USB data +	USB data signal – positive pole	Input/Output
4	GND	Negative pole of DC supply voltage	

Table 13: Connection of USB connector



Figure 35: USB connector

### 5.8.9 I/O Port

Panel socket 6-pin.

Pin	Signal mark	Description
1	IN0	Binary input 0
2	IN0	Binary input 0
3	IN1	Binary input 1
4	IN1	Binary input 1
5	OUT	Binary output
6	OUT	Binary output

Table 14: Connection of I/O port

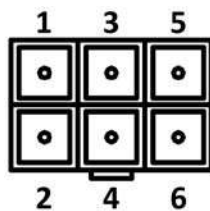

Figure 36: I/O connector

The I/O user Interface is designed for the processing of binary input and control (setting) of binary output. Binary output is open in the default configuration. The isolation strength is 1.5 kV. The pins are isolated from each other with the same strength.

The input circuits are bipolar and allow connection as needed with common plus or minus (according to the connection of an external voltage).

**Binary inputs**

- Characteristics of inputs:

logical 0 / 1*	Voltage	Current	Web interface status
log. 1 max	3 V	0.4 mA	Off
log. 0 min	5 V	0.7 mA	On
log. 0 type	12 V	2 mA	On
log. 0 max	60 V	7 mA	On

Table 15: Characteristics of inputs

\* The binary input status in the Shell is returned via `io get bin0` or `io get bin1`.

- Binary inputs connection example:

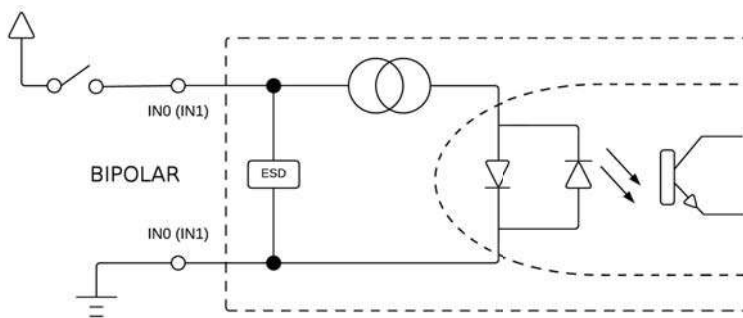

Figure 37: Binary inputs connection

### Binary output

- Binary output parameters:
  - 60 V AC / 300 mA
  - 60 V DC / 300 mA
- The current of the binary output is limited by a resettable fuse (300 mA).
- Binary output connection example:

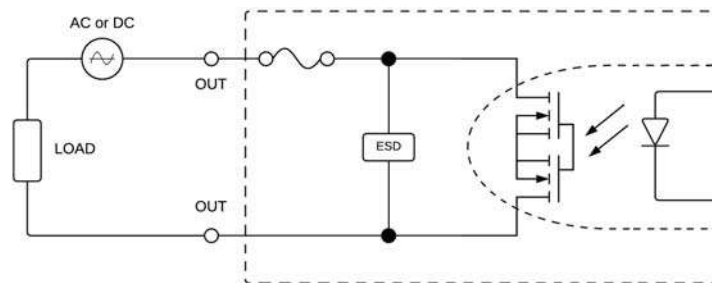

Figure 38: Binary output connection

### 5.8.10 Reset

When the *PWR* LED starts flashing on the front panel, it is possible to restore the default configuration of the router by pressing the *RST* button on the rear panel. After pressing this button the default configuration will be restored and the router will reboot (after which the green LED will be on).



In order to press the *RST* button it is necessary to use a narrow screwdriver or any other small tool.

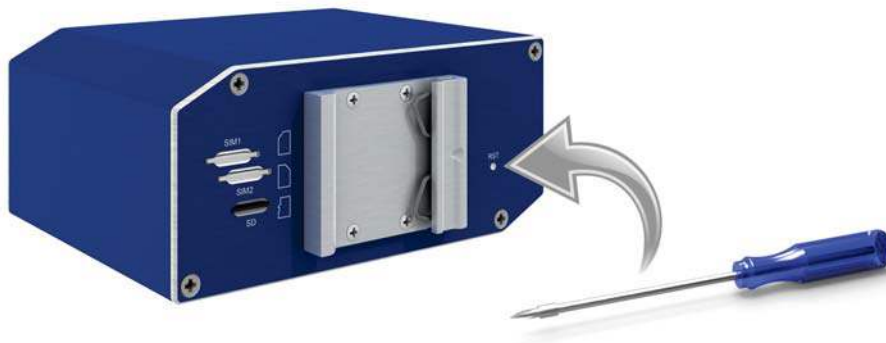

Figure 39: Router reset



Before resetting the router, it is recommended to back up the router configuration settings (see *Configuration manual*) because resetting the router will return all configuration settings to their default states.

It is important to distinguish between the router reset and reboot.

Action	Router behavior	Invoking events
Reboot	Turns off and then turns on the router	Disconnect and reconnect the power, press the <i>Reboot</i> button in the web configuration
Reset	Restores the default configuration and reboots the router	Press the <i>RST</i> button

Table 16: Description of router reset and restart

## **5.9 Interfaces Description**

Besides the basic version of the SmartFlex router there are other versions available with one of the following interfaces:

- RS232-RS485/422 interface
- SWITCH interface
- RS232-RS485-ETH interface

**5.9.1 RS232-RS485/422 interface**

These interfaces are physically connected through the 5-pin and 4-pin terminal block connectors. The insulation strength is up to 2.5 kV. **Attention, connectors are not isolated from each other!** No state indication is displayed for this interface. These router versions comply with the standards and temperature ranges stated in Chap. 7.1.

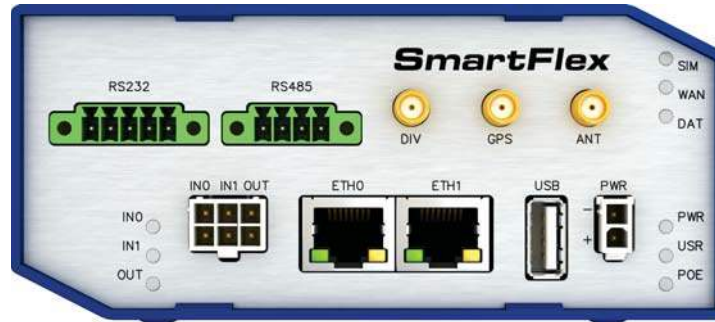

Figure 40: Version with RS232-RS485/422 interface



When connecting counterpart terminal block connectors (included in package with the router), use cables with nominal cross section 0.2 to 1.0 square mm (30 to 16 AWG). Recommended stripping length is 5 mm. For M2 captive screws the screw driver 0.5 x 3 mm is recommended. Tighten the screws with 0.3 Nm torque.

Connection of RS232 connector:

Pin	Signal	Description	Direction
1	CTS	Clear To Send	Output
2	RTS	Request To Send	Input
3	GND	Signal ground*	—
4	RXD	Receive Data	Input
5	TXD	Transmit Data	Output

Table 17: Connection of RS232 connector

\* Both connectors (RS232 and RS485/422) have a common ground connection.

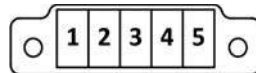

Figure 41: RS232 connector

Connection of RS485 connector:

Pin	Signal	Description	Direction
1	TxRx-	RS485 B (-)	Input/Output
2	TxRx+	RS485 A (+)	Input/Output
3	TxRx-	RS485 B (-)	Input/Output
4	TxRx+	RS485 A (+)	Input/Output

Table 18: Connection of RS485 connector

Connection of RS422 connector:

Pin	Signal	Description	Direction
1	RxD-	RS422 (-)	Output
2	RxD+	RS422 (+)	Output
3	TxD-	RS422 (-)	Input
4	TxD+	RS422 (+)	Input

Table 19: Connection of RS422 connector

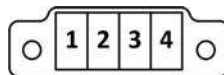

Figure 42: RS485/422 connector

The selection of either RS485 or RS422 can be performed by using jumpers on the board. The points where jumpers have to be mounted are shown on the port (see figure below). Three jumpers are required for the RS485 interface or one jumper for the RS422 interface. **The default configuration is RS485 with termination off.**



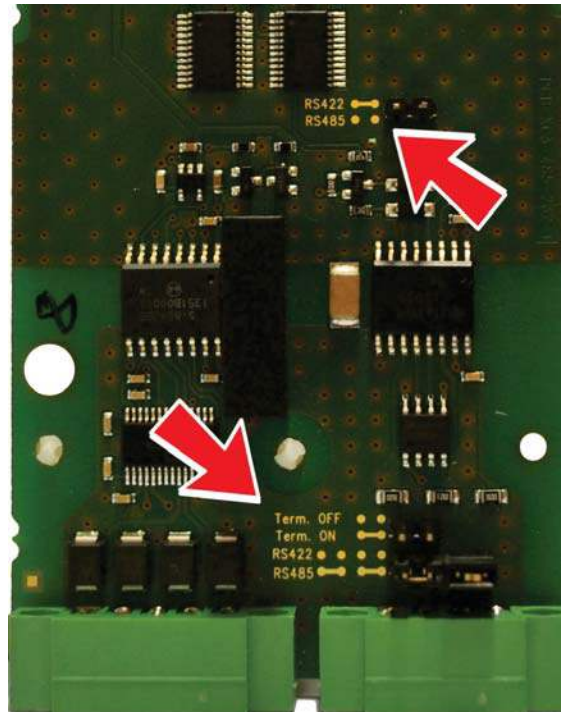

Figure 43: Connection of jumpers

Technical specification of RS232 and RS485 bus (EN 1434):

RS232 and RS485 interface	
Max. operating RS232 bus current	15 mA
Max. number of devices on RS485 bus (each 1,5 mA)	256
Max. data rate	230400 bps on RS232 230400 bps on RS485
Max. total cable length (300 Bd, 200 nF/km)	RS232 20 m, RS485 1200 m

Table 20: Technical specification of RS232 and RS485

### 5.9.2 SWITCH interface

The three LAN ports of the SWITCH interface for SmartFlex routers (RJ45 connectors for connecting Ethernet devices) act as a typical switch device. This means that the router reads Ethernet frames (data packets on an Ethernet link) from any port on the SWITCH interface and transmits them on other ports of the SWITCH interface. Each port can transmit frames independently on the other ports. State indication is displayed separately on each connector. These router versions comply with the standards and temperature ranges stated in Chap. 7.1 except for having a lower maximum operating temperature, which is +70 °C.

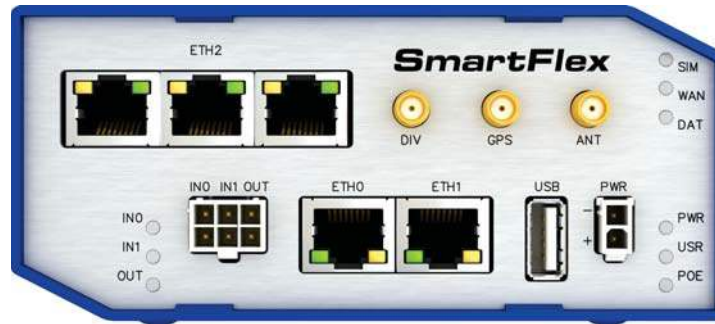

Figure 44: Version with SWITCH board

State indication of the interface:

Description of indication		
Green LED	On	Selected 100 Mbps
	Off	Selected 10 Mbps
Yellow LED	On	The network cable is connected
	Blinking	Data transmission
	Off	The network cable is not connected

Table 21: State indication of the SWITCH interface

Technical specification of Ethernet IEEE 802.3:

Ethernet interface, IEEE 802.3 standard	
Maximum data rate	100 Mbps
Max. total cable length (300 Bd, 200 nF/km)	100 m

Table 22: SWITCH interface parameters

### 5.9.3 RS232-RS485-ETH interface

This interface board includes a panel RJ45 connector for Ethernet connection (ETH2 in the figure), and four-pin and three-pin terminal block connectors for RS232 and RS485 connection. The insulation strength is up to 2.5 kV between the ETH2 and RS485 interfaces and from the rest of the router, too. The RS232 interface is not insulated from the rest of the router. State indication is displayed by LEDs above each connector, as shown in the table below. These router versions comply with the standards and temperature ranges stated in Chap. 7.1.



Figure 45: Version with RS232-RS485-ETH interface

Connection of ETH connector:

Pin	Signal	Description	Direction
1	TXD+	Transmit Data – positive pole	Input/Output
2	TXD-	Transmit Data – negative pole	Input/Output
3	RXD+	Receive Data – positive pole	Input/Output
4	—	—	—
5	—	—	—
6	RXD-	Receive Data – negative pole	Input/Output
7	—	—	—
8	—	—	—

Table 23: Connections of the Ethernet Connector

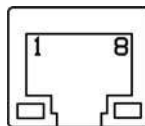

Figure 46: Ethernet connector



When connecting counterpart terminal block connectors (included in package with the router), use cables with nominal cross section 0.2 to 1.0 square mm (30 to 16 AWG). Recommended stripping length is 5 mm. For M2 captive screws the screw driver 0.5 x 3 mm is recommended. Tighten the screws with 0.3 Nm torque.

Connection of RS485 connector:

Pin	Signal	Description	Direction
1	GND	Signal ground*	—
2	TxRx-	RS485 B(-)	Input/Output
3	TxRx+	RS485 A(+)	Input/Output

Table 24: Connections of Terminal Block Connector RS485

\* Signal ground is isolated from the router's ground.

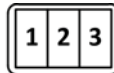

Figure 47: RS485 connector

Connection of RS232 connector:

Pin	Signal	Description	Direction
1	AUX	+5 V/500 mA	—
2	GND	Signal ground*	—
3	RXD	Receive Data	Input
4	TXD	Transmit Data	Output

Table 25: Connections of Terminal Block Connector RS232

\* Common with router's signal ground.

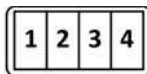

Figure 48: RS232 connector

State indication of the interface:

Description of indication		
ETH2 – green LED	On	Selected 100 Mbps
	Off	Selected 10 Mbps
ETH2 – Yellow LED	On	The network cable is connected
	Blinking	Data transmission
	Off	The network cable is not connected
RS485, RS232 – green LED		Indicates Receive data
RS485, RS232 – yellow LED		Indicates Transmit data

Table 26: State indication of the RS232-RS485-ETH interface

Technical specification of RS232 and RS485 bus (EN 1434) and Ethernet IEEE 802.3:

ETH2, RS485 and RS232 interface	
Max. operating RS232 bus current	15 mA
Max. number of devices on RS485 bus (each 1,5 mA)	256
Max. data rate	230400 bps on RS232 230400 bps on RS485 100 Mbps on ETH2
Max. total cable length (300 Bd, 200 nF/km)	RS232 20 m RS485 1200 m ETH2 100 m

Table 27: Technical specification of RS232, RS485 and Ethernet

## 6. First Use

### 6.1 Connecting the router before first use

Before putting the router into operation it is necessary to connect all of the components that are required to run your applications. Don't forget to insert a SIM card.



The router can not operate without a connected antenna, SIM card and power supply. If the antenna is not connected, the router may be damaged.

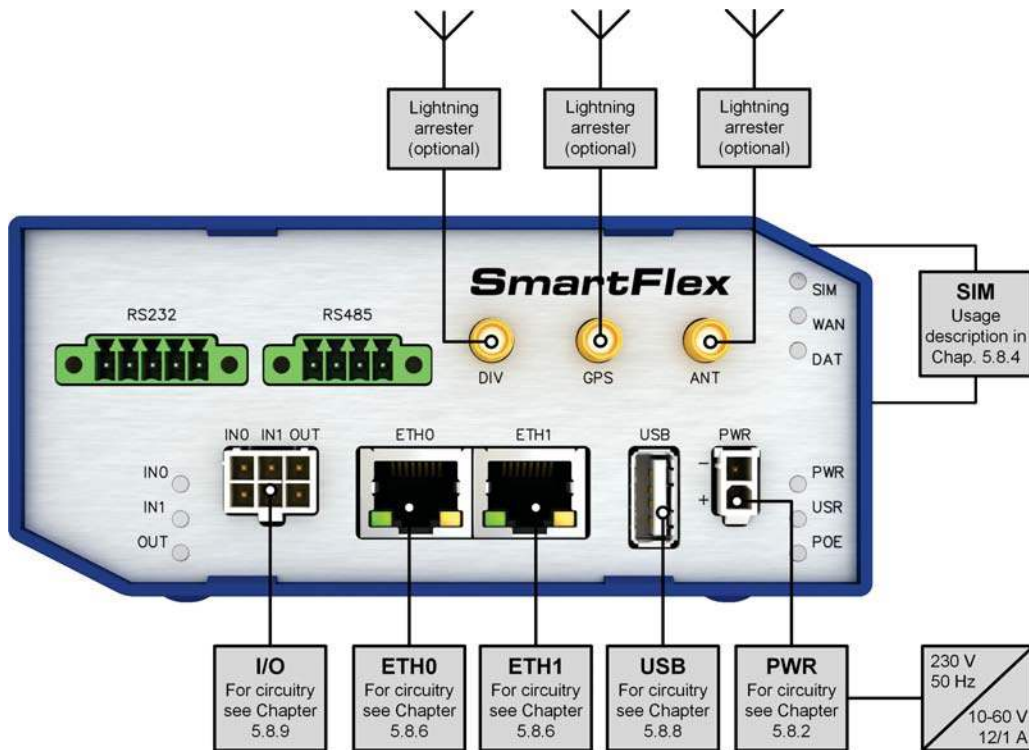

Figure 49: Router connection

## 6.2 Start

The router will start when a power supply is connected to the router. By default, the router will automatically start to log on to the default APN. The DHCP server will start to assign addresses for devices connected through the Ethernet port ETH0. These router behaviors can be changed via the web interface. This is described in detail in the *Configuration manual for SmartFlex routers*.

## 6.3 Configuration



**Attention!** If no SIM card is inserted in the router, it is not possible for the router to operate. Any inserted SIM card must have active data transmission.

### 6.3.1 Configuration by web browser

For status monitoring, configuration and administration of the router a web interface is available which can be accessed by entering the IP address of the router into the web browser. The default IP address of the router is 192.168.1.1. **Attention, it is necessary to use HTTPS protocol for secure communication over a network!**



Figure 50: Entering the IP address of the router

By default, configuration can only be performed with the default username "root" and default password "root".

Login	
Username	<input type="text"/>
Password	<input type="password"/>
<input type="button" value="Login"/>	

Figure 51: Entering login information

After successfully entering login information, the user will have access to the router web interface via their browser.

Status	General Status
<ul style="list-style-type: none"> <li>General</li> <li>Mobile WAN</li> <li>WiFi</li> <li>WiFi Scan</li> <li>Network</li> <li>DHCP</li> <li>IPsec</li> <li>DynDNS</li> <li>System Log</li> </ul>	<p><b>Mobile Connection</b></p> <p>SIM Card : Primary                      IP Address : 10.0.6.239                      Rx Data : 1.0 KB                      Tx Data : 3.3 KB                      Uptime : 0 days, 0 hours, 1 minute</p> <p>&gt; More Information &lt;</p> <p><b>Primary LAN</b></p> <p>IP Address : 192.168.1.1 / 255.255.255.0                      MAC Address : 7C:66:9D:35:8B:74                      Rx Data : 165.3 KB                      Tx Data : 431.7 KB</p> <p>&gt; More Information &lt;</p> <p><b>Secondary LAN</b></p> <p>IP Address : 192.168.2.1 / 255.255.255.0                      MAC Address : 7C:66:9D:35:8B:76                      Rx Data : 1.1 KB                      Tx Data : 7.9 KB</p> <p>&gt; More Information &lt;</p> <p><b>Tertiary LAN</b></p> <p>IP Address : 192.168.3.1 / 255.255.255.0                      MAC Address : 00:80:0F:11:70:00                      Rx Data : 0 B                      Tx Data : 0 B</p> <p>&gt; More Information &lt;</p> <p><b>WiFi</b></p> <p>IP Address : 192.168.4.1 / 255.255.255.0                      MAC Address : 84:B1:F7:21:2A:84                      Rx Data : 0 B                      Tx Data : 0 B</p> <p>&gt; More Information &lt;</p> <p><b>Peripheral Ports</b></p> <p>Expansion Port 1 : Ethernet Switch                      Expansion Port 2 : None                      Binary Input 1 : Off                      Binary Input 2 : Off                      Binary Output : Off</p> <p><b>System Information</b></p> <p>Firmware Version : 0.1.RC2 (2014-10-07) BETA                      Serial Number : N/A                      Profile : Standard                      Supply Voltage : 12.0 V                      Temperature : 45 °C                      Time : 2009-01-01 01:09:29                      Uptime : 0 days, 0 hours, 4 minutes</p>
<p><b>Configuration</b></p> <ul style="list-style-type: none"> <li>LAN</li> <li>VRRP</li> <li>Mobile WAN</li> <li>PPPoE</li> <li>WiFi</li> <li>WLAN</li> <li>Backup Routes</li> <li>Firewall</li> <li>NAT</li> <li>OpenVPN</li> <li>IPsec</li> <li>GRE</li> <li>LZTP</li> <li>PPTP</li> <li>DynDNS</li> <li>NTP</li> <li>SNMP</li> <li>SMTP</li> <li>SMS</li> <li>Expansion Port 1</li> <li>Expansion Port 2</li> <li>USB Port</li> <li>Startup Script</li> <li>Up/Down Script</li> <li>Automatic Update</li> </ul> <p><b>Customization</b></p> <ul style="list-style-type: none"> <li>User Modules</li> </ul> <p><b>Administration</b></p> <ul style="list-style-type: none"> <li>Remote Access</li> <li>Change Profile</li> <li><b>Change Password</b></li> <li>Add User</li> <li>Delete User</li> <li>Set Real Time Clock</li> <li>Set SMS Service Center</li> <li>Unlock SIM Card</li> <li>Send SMS</li> <li>Backup Configuration</li> <li>Restore Configuration</li> <li>Update Firmware</li> <li>Reboot</li> </ul>	

Figure 52: Router web interface



A detailed description of the router settings in the Web interface can be found in the *Configuration manual for SmartFlex routers*.



## 7. Technical Parameters

### 7.1 Basic parameters

SmartFlex Router		
Temperature range	Operating Storage	-40 °C to +75 °C -40 °C to +85 °C
Cold start	-35 °C -40 °C	Data transfers via mobile network are available immediately Data transfers via mobile network are available approximately five minutes after the start of the router. Everything else is functional immediately.
Humidity	Operating Storage	0 to 95 % relative humidity non condensing 0 to 95 % relative humidity non condensing
Altitude	Operating	2000 m / 70 kPa
Degree of protection		IP30
Supply voltage		10 to 60 V DC
Consumption	Idle Average Peak Sleep mode	2.5 W 4 W 11 W 10 mW
Dimensions		55 x 97 x 125 mm (DIN 35 mm, EN 60715)
Weight	Plastic box Metal box	approximately 170 g (depends on interface) approximately 375 g (depends on interface)
Antenna connectors		SMA – 50 Ω
User interface	2x ETH USB I/O	Ethernet (10/100 Mbps) USB 2.0 6-pin panel socket

Table 28: Basic parameters

## 7.2 Standards and regulations

The router complies with the following standards and regulations.

Standards and regulations	
Radio	ETSI EN 301 511 v9.0.2, ETSI EN 300 440-2 v1.4.1 ETSI EN 300 328 v1.8.1, ETSI EN 301 489-17 v2.2.1
Industrial	FCC 15.107 Class B, FCC 15.109 Class B FCC ID 2AIQR-SR305, Contains: FCC ID 2AIQR-PLS8-X, IC ID 7830A-PLS8X. WiFi versions contain FCC ID Z64-WL18DBMOD, IC ID 4511-WL18DBMOD. PTCRB ETSI EN 301 489-1 v1.9.2, IEC 61000-6-2:2005, IEC 61000-6-3:2006
Safety	EN 60950-1:2006 + A11:2009 + A1:2010 + A12:2011 + A2:2013, EN 62311:2008 UL 60950-1, 2nd ed. + am1 + am2 * CAN/CSA C22.2 No. 60950-1-07, 2nd ed. + am1 + am2 * UL E486108 * ATEX II 3 G Ex nA IIC T4 Gc, DEMKO 16 ATEX 1801X *
Carrier approvals	AT&T, Verizon

Table 29: Standards and regulations

\* Excluding versions with PoE PSE or RS232-RS485-ETH interface.

### 7.3 Type tests and environmental conditions

Phenomena	Test	Description	Test levels
ESD	EN 61000-4-2	Enclosure contact Enclosure air	± 6 kV (crit. A) ± 8 kV (crit. A)
RF field AM modulated	EN 61000-4-3	Enclosure	20 V/m (crit. A) (80 – 2700 MHz) 3 V/m (crit. A) (2700 – 6000 MHz)
Fast transient	EN 61000-4-4	Signal ports Power ports Ethernet ports	± 2 kV (crit. A) ± 2 kV (crit. A) ± 2 kV (crit. A)
Surge	EN 61000-4-5	Ethernet ports Power ports I/O ports	± 2 kV (crit. B), shielded cab. ± 0,5 kV (crit. B) ± 1 kV, L to L (crit. A) ± 2 kV, L to GND (crit. A)
RF conducted	EN 61000-4-6	All ports	10 V/m (crit. A) (0,15 – 80 MHz)
Radiated emission	EN 55022	Enclosure	Class B
Conducted emission	EN 55022	DC power ports Ethernet ports	Class B Class B
Power frequency magnetic field	EN 61000-4-8	Enclosure	160 A/m (crit. A)
Dry heat	EN 60068-2-2	+75 °C *, 40 % rel. humidity	
Cold	EN 60068-2-1	-40 °C *	
Dump heat	EN 60068-2-78	95 % rel. humidity (+40 °C)	

Table 30: Type tests and environmental conditions

\* The temperatures given are for the basic version of the router. These can vary for other versions.

### 7.4 Technical parameters of cellular module

Technical parameters of LTE module	
LTE features	Bit rate 100 Mbps (DL) / 50 Mbps (UL) 3GPP rel. 8 standard; UE CAT. 3 Output power: Class 3 (+23 dBm ±2 dB) Supported bandwidths: 5 MHz, 10 MHz, 20 MHz Supported frequencies: 700 (B13)/700 (B17)/850 (B5)/AWS (B4)/1900 MHz (B2)
HSPA+ features	Bit rate 42 Mbps (DL) / 5,76 Mbps (UL) 3GPP rel. 7 standard; UE CAT. 14, 24 Data compression 3GPP TS25.212 Supported frequencies: 850 (BV) / AWS (BIV) / 1900 MHz (BII)

Continued on next page

Continued from previous page

<b>Technical parameters of LTE module</b>	
UMTS features	PS bit rate 384 kbps (DL) / 384 kbps (UL) Output power: Class 3 (+24 dBm +1/-3 dB) Supported frequencies: 850 (BV) / AWS (BIV) / 1900 MHz (BII)
GPRS/EDGE features	Bit rate 237 kbps (DL) / 59,2 kbps (UL) GPRS multislot class 12, CS 1 to 4 EDGE multislot class 12, CS 1 to 4, MCS 1 to 9 Supported frequencies: 850 / 900 / 1800 / 1900 MHz
GPRS/EDGE power classes	EGSM 850 / 900: Class 4 (+33 dBm ±2 dB) GSM 1800 / 1900: Class 1 (+30 dBm ±2 dB) GSM 850 / 900: Class E2 (+27 dBm ±3 dB) GSM 1800 / 1900: Class E2 (+26 dBm +3/-4 dB)

Table 31: Technical parameters of LTE module

## 7.5 Technical parameters of GNSS

<b>GPS specifications</b>	
Antenna	50 Ohms – active
Protocols	NMEA 0183 v3.0
Frequency GPS	1575.42 MHz Typical
Frequency GLONASS	1597.551 MHz Min.; 1605.886 MHz Max.
Tracking Sensitivity * (Open sky)	Active antenna or LNA: -159 dBm Passive antenna: -156 dBm
Acquisition Sensitivity ** (Open sky)	Active antenna or LNA: -149 dBm Passive antenna: -145 dBm
Cold Start Sensitivity	-145 dBm
Acquisition time (TTFF)	Warm start: 29 s Max. Cold start: 32 s Max.

Table 32: Technical parameters of GNSS

\* Tracking sensitivity is the lowest GNSS signal level for which the device can still detect an in-view satellite 98 % of the time when in sequential tracking mode.

\*\* Acquisition sensitivity is the lowest GNSS signal level for which the device can still detect an in-view satellite 50 % of the time.

## 7.6 Technical parameters of WiFi

WiFi	
Antenna connector	R-SMA – 50 Ω
Supported WiFi band	2.4 GHz, 5 Ghz
Standards	802.11a, 802.11b, 802.11g, 802.11n
2.4 GHz supported channels	1, 2, 3, 4, 5, 6, 7, 8, 9, 10, 11
5 GHz supported channels	36, 40, 44, 48, 52, 56, 60, 64, 149, 153, 157, 161, 165
Type of device	Access point, station
Max. clients in AP mode	10
WiFi TX Output Power	17,3 dBm
WiFi RX Sensitivity	-96,3 dBm

Table 33: Technical parameters of WiFi

## 7.7 Technical parameters of I/O port

- Characteristics of inputs:

logical 0 / 1*	Voltage	Current	Web interface status
log. 1 max	3 V	0.4 mA	Off
log. 0 min	5 V	0.7 mA	On
log. 0 type	12 V	2 mA	On
log. 0 max	60 V	7 mA	On

Table 34: Characteristics of inputs

\* The binary input status in the Shell is returned via `io get bin0` or `io get bin1`.

- Binary output parameters:
  - 60 V AC / 300 mA
  - 60 V DC / 300 mA

## 7.8 Technical Parameters of Power over Ethernet (PoE)

Standards IEEE 802.3at-2009 (PoE+) and IEEE 802.3af-2003 (PoE) are supported. Cabling needed is Category 5, up to 12.5 Ω. It is possible to use a passive PoE injector.

<b>PoE PD: parameters for opposite PSE</b>	
Input voltage range	42.5 – 57 V
Power available	25.50 W
Maximum current	600 mA

Table 35: PoE PD: parameters for opposite PSE

<b>PoE PSE parameters</b>	
Power supply needed	44 – 57 V, 65 W
Power available	2x 25.50 W (ETH0, ETH1)

Table 36: PoE PSE parameters

## 7.9 Other Technical Parameters

<b>Other technical parameters</b>	
CPU power	2 DMIPS per MHz
Flash memory	256 MB
RAM	512 MB
M-RAM	128 kB

Table 37: Other technical parameters

## 8. Recommended Literature

- [1] Advantech B+B SmartWorx: **Start Guide for SmartFlex,**
- [2] Advantech B+B SmartWorx: **Configuration Manual for SmartFlex Routers.**

## 9. Troubleshooting

If you cannot connect to the router from your PC, your network card may be configured in such a way that it is not possible to connect to the router. Take one or more of the following steps in order to solve the problem:



- Set the communication rate to 10 MB/s in the properties of your network card.
- Connect the router to the PC via Switch.
- Connect the router to the PC, start the router first and then start the PC after the router's initialization.

### 9.1 FAQ

 **I have NAT enabled. My equipment is not connecting to the network.**

- *The device's gateway has to be configured the same as the router's.*

 **The router resets itself and the Ethernet connection fails.**

- *The router will not function without an antenna. Keep the antenna as far as possible from the power supply.*

 **I can't access the Web server over NAT.**

- *The remote HTTP access of the router has to be disabled, the default server address has to be your web server and the gateway of the web server has to be the IP of the router.*

 **Mobile WAN connection fails. (DAT LED off)**

- *Check the signal power. If the signal power is weak, you will have to use a better antenna. If the neighboring cells have a similar signal strength, you will need to use a directional antenna. For proper operation, the signal levels have to be within the range of -50 dBm to -90 dBm.*
- *It is necessary to set the router to ping, which will check the connection and, in the case of a failed ping, restart the connection.*

 **Mobile WAN connection cannot be established. (DAT LED off)**

- *Check the GPRS settings – APN, name, password and IP address.*
- *Try to enter the SIM card PIN – verify that the SIM card has the PIN code entered.*
- *In a private APN, switch the DNS server send off.*
- *Switch the system log on and observe to see where the error occurs.*



 **Ethernet connection fails or isn't establishing.**

- *It is possible to turn auto negotiation off and set a rate and duplex manually on the Ethernet interface of the router.*

 **DynDNS doesn't function.**

- *With private APN this is not functional.*
- *If the same IP address is recorded in your canonic name as a dynamically assigned address, it means that the operator is using NAT or a firewall.*
- *Verify NAT using ping to the static server address.*
- *Verify a Firewall by accessing remotely to the router's Web interface.*
- *The operator may not provide the address of DNS server and without DNS server's address it is impossible to connect to the dyndns.org server. The following messages will be shown in the system log:*
  - *DynDNS daemon started*
  - *Error resolving hostname: no such file or directory*
  - *Connect to DynDNS server failed*

 **L2TP or IPSec isn't establishing.**

- *Check the system log for error messages.*

 **I switched the router to offline mode by SMS message, but the router is in online mode after restart.**

- *SMS messages do not change the router configuration. They remain in effect only until the router is restarted.*

 **Serial communication is not functional.**

- *Verify that the router supports serial communications. Also verify the serial communication settings. To do so, open the router's configuration menu via the web browser, select the appropriate expansion port and verify the settings in the configuration menu.*

## 10. Customers Support

### 10.1 Customer Support for NAM

Phone: +1-800-346-3119 (Monday – Friday, 7 a.m. to 5:30 p.m. CST)  
Fax: +1-815-433-5109  
E-mail: [support@advantech-bb.com](mailto:support@advantech-bb.com)  
Web: [www.advantech-bb.com](http://www.advantech-bb.com)

### 10.2 Customer Support for Europe

Phone: +353 91 792444  
Fax: +353 91 792445  
E-mail: [techSupport@advantech-bb.com](mailto:techSupport@advantech-bb.com)  
Web: [www.advantech-bb.com](http://www.advantech-bb.com)

### 10.3 Customer Support for Asia

Phone: +886-2-2792-7818 #1299 (Monday – Friday, 9 a.m. to 5:30 p.m. UTC+8)  
Fax: +886-2-2794-7327  
E-mail: [icg.support@advantech.com.tw](mailto:icg.support@advantech.com.tw)  
Web: [www.advantech.com](http://www.advantech.com)



#### Upkeep-advice:

- The SIM-card must be handled carefully as with a credit card. Don't bend, don't scratch on this and do not expose to static electricity.
- During cleaning of the router do not use aggressive chemicals, solvents and abrasive cleaners!



Hereby, Advantech B+B SmartWorx s.r.o. company declares that the radio equipment narrated in this user's guide is in compliance with EU Directive **2014/53/EU**.

The full text of the EU Declaration of Conformity is available at the following internet address:  
[www.advantech-bb.cz/eudoc](http://www.advantech-bb.cz/eudoc)