

Cable gland - HC-B-GB-M20-ER-AL - 1414663

Please be informed that the data shown in this PDF Document is generated from our Online Catalog. Please find the complete data in the user's documentation. Our General Terms of Use for Downloads are valid (<http://phoenixcontact.com/download>)



Set consisting of: EVO metal adapter 1414256, metal screw connection with bending armor rod 1415182, M20



Key Commercial Data

Packing unit	1 pc
Weight per Piece (excluding packing)	220.0 g
Custom tariff number	85389099
Country of origin	Germany

Technical data

Dimensions

Wrench size, union nut	24 mm
Wrench size, support	24 mm
External cable diameter	6 mm ... 13 mm

Ambient conditions

Ambient temperature (operation)	-40 °C ... 100 °C
---------------------------------	-------------------

General

Cable gland material	Nickel-plated brass
Material, pressure screw	Nickel-plated brass
Thread type on connection side	Bayonet
Thread type on seal side	M20

Classifications

eCl@ss

eCl@ss 5.1	27143424
------------	----------

Cable gland - HC-B-GB-M20-ER-AL - 1414663

Classifications

eCl@ss

eCl@ss 6.0	27261207
------------	----------

ETIM

ETIM 5.0	EC000441
----------	----------

Approvals

Approvals

Approvals

EAC

Ex Approvals

Approvals submitted

Approval details

EAC

Drawings

Cable gland - HC-B-GB-M20-ER-AL - 1414663

Dimensional drawing

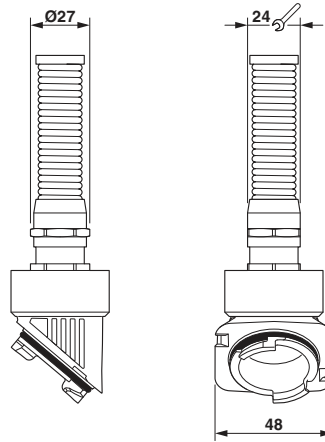

Dimensional drawing