

EMC-KT

EMC Grommets

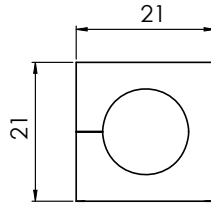

IP54



EMC-KT small

Product Description

The cable grommets type EMC-KT are made of a very conductive elastomer. Thus, faults are dissipated from the cable shield directly via the grommet, a frame and the flat gasket. This ensures full-area protection against field-bound interference!

Assembly















When installing the grommets, the flat side should be facing the middle of the frame. This allows the flat sides of adjacent grommets to match up and provide a secure seal.

Specifications

Material	Elastomer, conductive
Flame class	in accordance with UL94-HB
Colour	black
Operating temperature	-30°C to +80°C -22°F to +176°F
Properties	Halogen free, silicone free

Accessories

ST Plugs 53

Description	Type	Ordner No.	Clamping range	PU
	EMC-BTK	99473	blank grommet	5
	EMC-KT 3	99460	3 - 4 mm 0.118 - 0.157 "	5
	EMC-KT 4	99461	4 - 5 mm 0.157 - 0.197 "	5
	EMC-KT 5	99462	5 - 6 mm 0.197 - 0.236 "	5
	EMC-KT 6	99463	6 - 7 mm 0.236 - 0.276 "	5
	EMC-KT 7	99464	7 - 8 mm 0.276 - 0.315 "	5
	EMC-KT 8	99465	8 - 9 mm 0.315 - 0.354 "	5
	EMC-KT 9	99466	9 - 10 mm 0.354 - 0.394 "	5
	EMC-KT 10	99467	10 - 11 mm 0.394 - 0.433 "	5
	EMC-KT 11	99468	11 - 12 mm 0.433 - 0.472 "	5
	EMC-KT 12	99469	12 - 13 mm 0.472 - 0.512 "	5
	EMC-KT 13	99470	13 - 14mm 0.512 - 0.551 "	5
	EMC-KT 14	99471	14 - 15 mm 0.551 - 0.591 "	5
	EMC-KT 15	99472	15 - 16 mm 0.591 - 0.63 "	5

EMC-KT

EMC Grommets

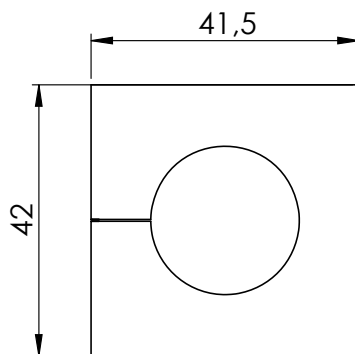

EMC-KT large

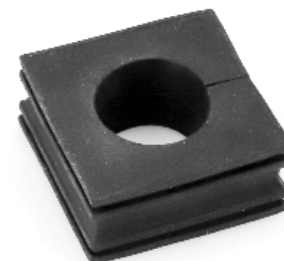

Description	Type	Ordner No.	Clamping range	PU
	EMC-BTG	99495	blank grommet	5
	EMC-KT 16	99475	16 - 17 mm 0.63 - 0.669 "	5
	EMC-KT 17	99476	17 - 18 mm 0.669 - 0.709 "	5
	EMC-KT 18	99477	18 - 19 mm 0.709 - 0.748 "	5
	EMC-KT 19	99478	19 - 20 mm 0.748 - 0.787 "	5
	EMC-KT 20	99479	20 - 21 mm 0.787 - 0.827 "	5
	EMC-KT 21	99480	21 - 22 mm 0.827 - 0.866 "	5
	EMC-KT 22	99481	22 - 23 mm 0.866 - 0.906 "	5
	EMC-KT 23	99482	23 - 24 mm 0.906 - 0.945 "	5
	EMC-KT 24	99483	24 - 25 mm 0.945 - 0.984 "	5

Product Description

The cable grommets type EMC-KT are made of a very conductive elastomer. Thus, faults are dissipated from the cable shield directly via the grommet, the frame and the flat gasket. This ensures full-area protection against field-bound interference!

Assembly

When installing the grommets, the flat side should be facing the middle of the frame. This allows the flat sides of adjacent grommets to match up and provide a secure seal.

Specifications

Material	Elastomer, conductive
Flame class	in accordance with UL94-HB
Colour	black
Operating temperature	-30°C to +80°C -22°F to +176°F
Properties	Halogen free, silicone free

Accessories

ST Plugs 53

4.2