



Ultrasonic sensors

Ultrasonic sensor disk, 7.000 x 0.195 mm, 50 pcs./ tube

Series/Type: Z070 D 0285 A121
Ordering code: B59070Z0285D121
Date: 2019-07-17

Applications

Piezo disk in radial oscillation mode for ultrasonic sensor applications e.g.

- Automotive applications:
 - Ultrasonic park assist systems
 - Interior monitoring and anti-theft systems
- Industrial applications:
 - Flow meters for gases
 - Level sensing for bulk materials
 - Collision avoidance systems

Dimensional drawings

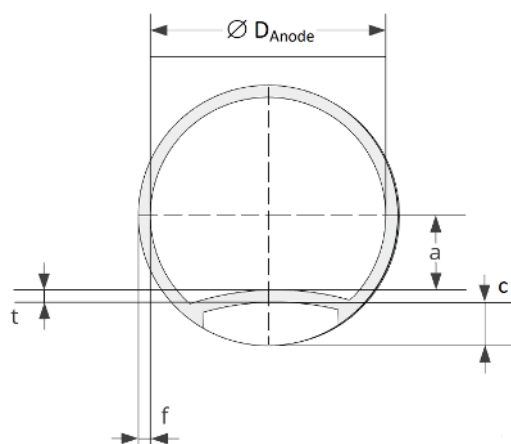

Features

- Silver metallization
- Wrap around metallization
- Temperature range -40 °C up to 160 °C
- RoHS-compatible

Options

- Other dimensions and ratings on request

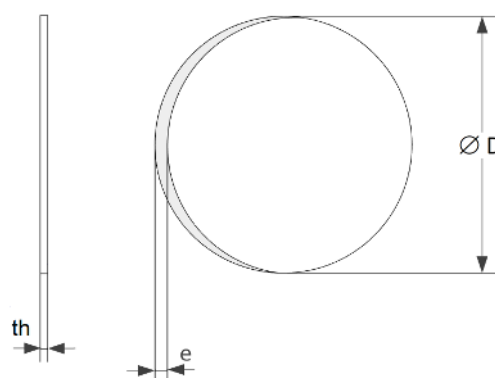

Delivery mode

- Packed in plastic tubes,
50 pcs./ tube

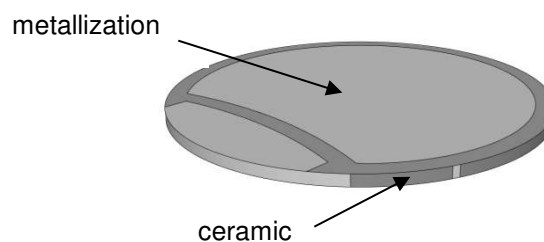

Wrap around metallization

Electrodes on top and bottom side are connected by wrap around metallization.

Dimensions

	Parameter	Symbol	Unit	Min.	Typical	Max.
1	Diameter of ceramics	$\varnothing D$	mm	6.80	7.00	7.20
2	Anode diameter	$\varnothing D_{\text{Anode}}$	mm	6.15	6.35	6.55
3	Thickness of ceramics	th	μm	175	195	215
4	Thickness of metallization	th _M	μm	-	8	-
5	Free zone on trench width side	f	mm	0.1	-	-
6	Trench width	t	μm	210	-	450
7	Free zone on bottom side	e	mm	-	-	0.50
8	Distance trench edge to piezo center	a	mm	1.80	2.00	2.20
9	Distance trench edge to piezo edge	c	mm	-	1.15	-

Electrical specification

	Parameter	Symbol	Unit	Min.	Typical	Max.
1	Capacitance	C	nF	-15%	2.00	+15%
2	Serial resonance frequency	f _s	kHz	-5%	285	+5%
3	Effective coupling	k _{eff}	-	0.48	-	-
4	Resistance of wrap around	R _{wa}	m Ω	-	-	500

Material parameters

	Parameter	Symbol	Unit	Min.	Typical	Max.
1	Curie temperature	T _c	$^{\circ}\text{C}$	-	340	-
2	Dielectric loss	tan δ	-	-	0.02	-
3	Density	δ	kg/m ³	-	7800	-
4	Piezoelectric constant	d ₃₃	pC/N	-	420	-
5	Elastic compliance	s ₃₃ E	m ² /N	-	19.6*10 ⁻¹²	-

Cautions and warnings

General

Some parts of this publication contain statements about the suitability of our products for certain areas of application. These statements are based on our knowledge of typical requirements that are often placed on our products in the areas of application concerned. We nevertheless expressly point out that such statements cannot be regarded as binding statements about the suitability of our products for a particular customer application. As a rule we are either unfamiliar with individual customer applications or less familiar with them than the customers themselves. For these reasons, it is always ultimately incumbent on the customer to check and decide whether a product with the properties described in the product specification is suitable for use in a particular customer application.

- Do not use TDK piezo components for purposes not identified in our specifications, application notes and data books.
- Ensure the suitability of a piezo component in particular by testing it for reliability during design-in. Always evaluate a piezo component under worst-case conditions.
- Pay special attention to the reliability of piezo devices intended for use in safety-critical applications (e.g. medical equipment, automotive, spacecraft, nuclear power plant).

Design notes

- Consider maximum power dissipation if a piezo device has insufficient time to cool down between a numbers of pulses occurring within operating time. The piezo device is only allowed to operate in non-continuous operating mode. Ensure that surface temperature does not increase above specified temperature range and that electrical characteristics do not degrade.
- Consider derating at higher operating temperatures.
- We also point out that in individual cases, a malfunction of electronic components or failure before the end of their usual service life cannot be completely ruled out in the current state of the art, even if they are operated as specified. In customer applications requiring a very high level of operational safety and especially in customer applications in which the malfunction or failure of an electronic component could endanger human life or health (e.g. in accident prevention or life-saving systems), it must therefore be ensured by means of suitable design of the customer application or other action taken by the customer (e.g. installation of protective circuitry or redundancy) that no injury or damage is sustained by third parties in the event of malfunction or failure of an electronic component.
- Specified values only apply to piezo components that have not been subject to prior electrical, mechanical or thermal damage.

Storage

- Only store piezo component devices in their original packaging. Do not open the package before storage.
- Storage conditions in original packaging: temperature $-25\text{ }^{\circ}\text{C}$ to $+45\text{ }^{\circ}\text{C}$, relative humidity $\leq 75\%$ annual average, maximum 95%, dew precipitation is inadmissible.
- Do not store piezo component devices where they are exposed to heat or direct sunlight. Otherwise the packaging material may be deformed or piezo components may stick together, causing problems during mounting.
- Avoid contamination of the piezo components surface during storage, handling and processing.
- Avoid storing piezo component devices in harmful environments where they are exposed to corrosive gases for example (SO_x, Cl).
- Use piezo components as soon as possible after opening factory seals such as polyvinyl sealed packages.
- Use piezo components within 12 months after delivery.

Handling

- Do not drop piezo components and allow them to be chipped.
- Do not touch piezo component devices with your bare hands - gloves are recommended.
- Avoid contamination of the piezo component surface during handling.
- Piezo components can be damaged by electrostatic discharge (ESD). When handling, care must be taken so that the devices are not damaged. Damage due to inappropriate handling is not covered by the warranty.

Mounting

- Make sure an electrode is not extensively scratched before, during or after the mounting process.
- Make sure contacts and housings used for assembly with piezo components are clean before mounting.
- The surface temperature of an operating piezo component device can be higher. Ensure that adjacent components are placed at a sufficient distance from a piezo component to allow proper cooling.
- Avoid contamination of the piezo component device surface during processing.

Operation

- Use piezo components only within the specified operating temperature range.
- Environmental conditions must not harm piezo component device. TDK piezo component components are mainly designed for encased applications. Under all circumstances avoid exposure to:
 - direct sunlight
 - rain, condensation or dewing
 - steam, saline spray
 - corrosive gases
 - atmosphere with reduced oxygen content (e.g. hydrogen or nitrogen atmosphere)
 - liquids and solvents

The following should be considered in circuit board design of SMD assembly

- Piezo elements must always be placed a sufficient minimum distance from the edge of the circuit board. High bending forces may be exerted there when the panels are separated and during further processing of the board (such as when incorporating it into a housing).
- Piezo elements (e.g. rectangular design) should always be placed parallel to the possible bending axis of the circuit board.
- Components should not be placed near screw holes. If screw connections are unavoidable, they must be cushioned (for instance by rubber pads).

The following should be considered in the placement process of SMD assembly

- Ensure correct positioning of the piezo element on the solder pad.
- Caution when using casting, injection-molded and molding compounds and cleaning agents, as these may damage the piezo element.
- Support the circuit board and reduce the placement forces.
- A board should not be straightened (manually) if it has been distorted by soldering.
- Separate panels with a peripheral saw, or better with a milling head (no dicing or breaking).
- Caution in the subsequent placement of heavy or leaded components (e.g. elements or snap-in components): danger of bending and fracture.
- When testing, transporting, packing or incorporating the board, avoid any deformation of the board not to damage the components.
- Avoid the use of excessive force when plugging a connector into a device soldered onto the board.

This listing does not claim to be complete, but merely reflects the experience of TDK Electronics.

Important notes

The following applies to all products named in this publication:

1. Some parts of this publication contain **statements about the suitability of our products for certain areas of application**. These statements are based on our knowledge of typical requirements that are often placed on our products in the areas of application concerned. We nevertheless expressly point out **that such statements cannot be regarded as binding statements about the suitability of our products for a particular customer application**. As a rule we are either unfamiliar with individual customer applications or less familiar with them than the customers themselves. For these reasons, it is always ultimately incumbent on the customer to check and decide whether a product with the properties described in the product specification is suitable for use in a particular customer application.
2. We also point out that **in individual cases, a malfunction of electronic components or failure before the end of their usual service life cannot be completely ruled out in the current state of the art, even if they are operated as specified**. In customer applications requiring a very high level of operational safety and especially in customer applications in which the malfunction or failure of an electronic component could endanger human life or health (e.g. in accident prevention or life-saving systems), it must therefore be ensured by means of suitable design of the customer application or other action taken by the customer (e.g. installation of protective circuitry or redundancy) that no injury or damage is sustained by third parties in the event of malfunction or failure of an electronic component.
3. **The warnings, cautions and product-specific notes must be observed.**
4. In order to satisfy certain technical requirements, **some of the products described in this publication may contain substances subject to restrictions in certain jurisdictions (e.g. because they are classed as hazardous)**. Useful information on this will be found in our Material Data Sheets on the Internet (www.tdk-electronics.tdk.com/material). Should you have any more detailed questions, please contact our sales offices.
5. We constantly strive to improve our products. Consequently, **the products described in this publication may change from time to time**. The same is true of the corresponding product specifications. Please check therefore to what extent product descriptions and specifications contained in this publication are still applicable before or when you place an order.

We also **reserve the right to discontinue production and delivery of products**. Consequently, we cannot guarantee that all products named in this publication will always be available. The aforementioned does not apply in the case of individual agreements deviating from the foregoing for customer-specific products.

6. Unless otherwise agreed in individual contracts, **all orders are subject to our General Terms and Conditions of Supply**.
7. **Our manufacturing sites serving the automotive business apply the IATF 16949 standard**. The IATF certifications confirm our compliance with requirements regarding the quality management system in the automotive industry. Referring to customer requirements and customer specific requirements ("CSR") TDK always has and will continue to have the policy of respecting individual agreements. Even if IATF 16949 may appear to support the acceptance of unilateral requirements, we hereby like to emphasize that **only requirements mutually agreed upon can and will be implemented in our Quality Management System**. For clarification purposes we like to point out that obligations from IATF 16949 shall only become legally binding if individually agreed upon.

Important notes

8. The trade names EPCOS, CeraCharge, CeraDiode, CeraLink, CeraPad, CeraPlas, CSMP, CTVS, DeltaCap, DigiSiMic, ExoCore, FilterCap, FormFit, LeaXield, MiniBlue, MiniCell, MKD, MKK, MotorCap, PCC, PhaseCap, PhaseCube, PhaseMod, PhiCap, PowerHap, PQSine, PQvar, SIFERRIT, SIFI, SIKOREL, SilverCap, SIMDAD, SiMic, SIMID, SineFormer, SIOV, ThermoFuse, WindCap are **trademarks registered or pending** in Europe and in other countries. Further information will be found on the Internet at www.tdk-electronics.tdk.com/trademarks.

Release 2018-10