

## RF CHARACTERISTICS

Frequency range : **0 - 18 GHz**  
Impedance : **50 Ohms**

Frequency (GHz)	DC - 3	3 - 8	8 - 12.4	12.4 - 18
VSWR max	<b>1.20</b>	<b>1.30</b>	<b>1.40</b>	<b>1.50</b>
Insertion loss max	<b>0.20 dB</b>	<b>0.30 dB</b>	<b>0.40 dB</b>	<b>0.50 dB</b>
Isolation min	<b>80 dB</b>	<b>70 dB</b>	<b>60 dB</b>	<b>60 dB</b>
Average power (*)	<b>240 W</b>	<b>150 W</b>	<b>120 W</b>	<b>100 W</b>

## ELECTRICAL CHARACTERISTICS

Actuator : **FAILSAFE**  
Nominal current \*\* : **205 mA**  
Actuator voltage (Vcc) : **28V (24 to 30V)**  
Terminals : **solder pins (250°C max. / 30 sec.)**  
Indicator rating : **1 W / 30 V / 100 mA**

## MECHANICAL CHARACTERISTICS

Connectors : **SMA female per MIL-C 39012**  
Life : **2 million cycles**  
Switching Time\*\*\* : **< 10 ms**  
Construction : **Splashproof**  
Weight : **< 100 g**

## ENVIRONMENTAL CHARACTERISTICS

Operating temperature range : **-40°C to +85°C**  
Storage temperature range : **-55°C to +85°C**

(\* Average power at 25°C per RF Path)

(\*\* At 25° C ±10%)

(\*\*\* Nominal voltage ; 25° C)



PAGE 2/2

ISSUE 09-03-21

SERIE : SPDT ZC

PART NUMBER : R585423230

**DRAWING**

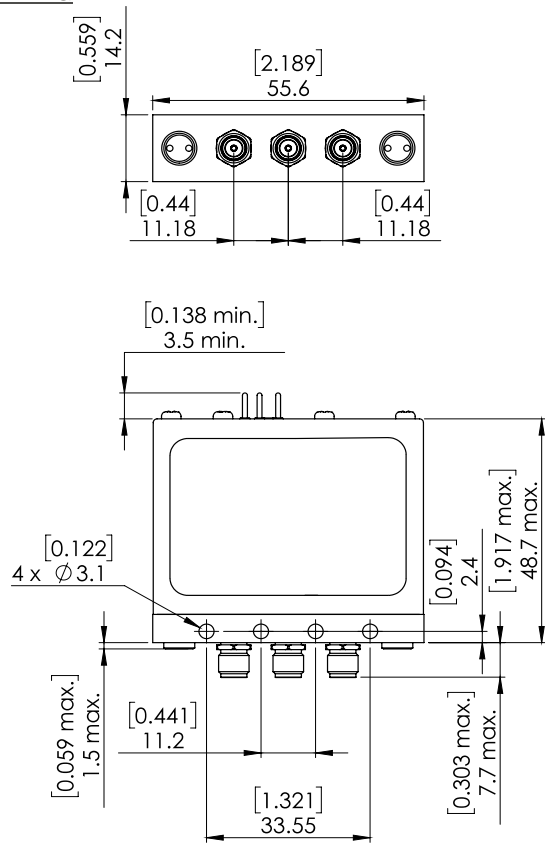

**LABEL**

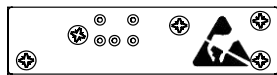
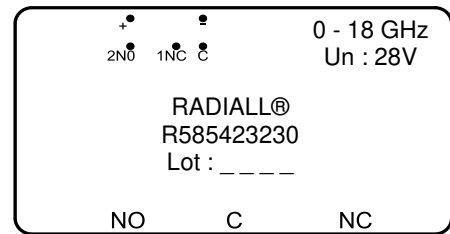

General tolerances : ±0,5 mm [0,02 in]

**SCHEMATIC DIAGRAM**

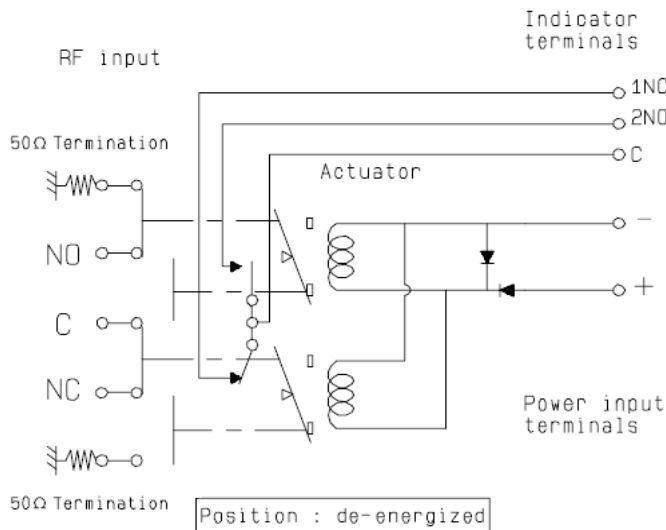

Position	RF Continuity	Indicator
De-energized	C↔NC / NO↔50Ω	C.1NC
energized	C↔NO / NC↔50Ω	C.2NO