



**X-Strobe™ Series
MACHINE VISION STROBES**

OPERATION MANUAL

*Excelitas Technologies Corp.
35 Congress St., Salem, MA 01970 USA
Phone: (978)745-3200 FAX: (978)745-0894
Toll Free: (800)950-3441 in USA only
Website <http://www.excelitas.com>*



WARNING!

The X-Strobe™ produces lethal voltages. Ensure that input power is disconnected and storage capacitors have been discharged before beginning any inspection or internal adjustment.

WARNUNG!

Das X-Strobe™ erzeugt lebensgefährliche Spannungen. Es muss deshalb darauf geachtet werden, dass der ankommende Strom ausgeschaltet ist und die Ladekondensatoren entladen sind, bevor Kontrollen oder Regelungen am Gerät unternommen werden!

ATTENTION!

Le X-Strobe™ fournit des tensions dangereuses. Veuillez vérifier que la prise de courant est déconnectée et les condensateurs d'accumulation sont déchargés avant d'entreprendre des inspections ou des réglages sur l'appareil.



WARNING!

The output voltage of the X-Strobe™ MUST be limited to match the specifications of those components to which it is connected. Exposing any system component to voltage (or any other operating condition) that exceeds its rating can result in damage to the unit and personal injury.



WARNUNG!

Die Ausgangsspannung des X-Strobe™ muss der Leistung aller damit verbundenen Komponenten angepasst werden. Systemelemente Spannungen (oder anderen Betriebsbedingungen) auszusetzen, die die Leistungswerte jener Komponenten übertreffen, ist gefährlich und kann zu Schäden und Verletzungen führen.

ATTENTION!

Il faut que la tension fournie par le X-Strobe™ soit limitée aux caractéristiques des composants auxquels il sera mis en contact. En exposant un composant quelconque à une tension (ou à d'autres conditions de fonctionnement), qui en dépasse la limite on pourrait endommager l'appareil ou provoquer des blessures.



WARNING!

Do not exceed the specified rates for voltage and flashrate. Do not operate at more than 43 watts of average output power.

WARNUNG!

Bitte, die vorgegebenen Grenzwerte bei der Spannung und Blitzfrequenz nicht überertreffen. Leistungen höher als 43 Watt sind nicht zulässig.

ATTENTION!

Eviter de dépasser les valeurs limits inscrites pour la tension et la fréquence d'éclat. Eviter aussi des puissances au dessus de 43 Watt.

TABLE OF CONTENTS

	PAGE
1.0 INTRODUCTION _____	2
1.1. DESCRIPTION _____	2
1.2. UNPACKING _____	2
2.0 SPECIFICATION TABLES _____	3
3.0 INSTALLATION _____	4
3.1. MOUNTING _____	4
3.2. SAFETY REQUIREMENTS _____	4
4.0 OPERATION _____	4
4.1. OUTPUT CONNECTIONS _____	4
4.2. INPUT CONNECTIONS _____	5
4.2.1. TRIGGER CONTROL _____	5
4.2.2. Vref INPUT _____	5
4.3. INTENSITY ADJUSTMENT (INTERNAL MODE) _____	6
4.4. VOLTAGE SETTING VERSUS LAMP LIFE _____	6
5.0 MAINTENANCE _____	6
5.1. REPAIRS _____	6
5.2. FLASHLAMP MODULE REPLACEMENT _____	7
5.3. CLEANING _____	7
5.4. REPACKING AND STORAGE _____	7
6.0 DECLARATION OF CONFORMITY _____	8

FIGURES

FIGURE 1. OUTLINE AND MOUNTING DIMENSIONS _____	2
FIGURE 2: SIGNAL INPUT CONNECTOR (J2) _____	5
FIGURE 3: INPUT TRIGGER CIRCUIT _____	5

TABLES

TABLE 1: OPTICAL SPECIFICATIONS _____	3
TABLE 2: ELECTRICAL SPECIFICATIONS _____	3
TABLE 3: ENVIRONMENTAL SPECIFICATIONS _____	3
TABLE 4: NOSEPIECES _____	4
TABLE 5: FIBER OPTIC BUNDLES _____	4
TABLE 6: SIGNAL INPUT CONNECTOR - J2 _____	5

1.0 INTRODUCTION



1.1. DESCRIPTION

Machine Vision Strobes (hereafter referred to as the "X-Strobe™ Series") are sources of short duration, high intensity light pulses for industrial vision applications. The X-Strobe™ is supplied complete with an input power cable and a connector for a control input cable. The light source is a Excelitas Technologies high power xenon flashlamp. The light output is focused on a port configured to accept a fiber-optic cable (optional; see Table 4) so that light can be transmitted to an area remote from the instrument.

The X-Strobe™ Series can be used for a wide variety of industrial robotics production applications, including: sorting, package integrity verification, counting, label reading, component orientation, motion sensing, edge detection, contaminant detection, part recognition, color differentiation and quality assurance.

For operation, the X-Strobe™ Series unit requires a TTL input pulse from the camera system to initiate a flash, and connection to a 100-240V AC, 50/60Hz line, single phase with ground.

Please read and follow all safety precautions, such as:

 <p>WARNING! Any unauthorized modifications could Void CE Certification.</p>	 <p>WARNING! Strobe lights have been known to trigger seizures in people with photosensitive epilepsy.</p>
 <p>WARNING! Avoid looking directly at the high intensity light flash, whether at the unit itself or at the end of a fiber-optic cable, as this can result in damage to the eyes. A fiber-optic nosepiece is hot after continuous use. Handle with care.</p>	

1.2. UNPACKING

If the condition of the outer packaging suggests mishandling has occurred, examine the X-Strobe™ Series strobe for any signs of breakage during shipment. The Xenon Flashlamp is particularly vulnerable to rough treatment during shipment. Although the utmost care is taken to preserve the integrity of this item, its fragile nature makes it susceptible to breakage if the container is mishandled in transit. If there are any obvious signs of damage, contact the carrier immediately and do not proceed with the installation. It is recommended that the packaging material be retained and stored in the event that the unit has to be reshipped.

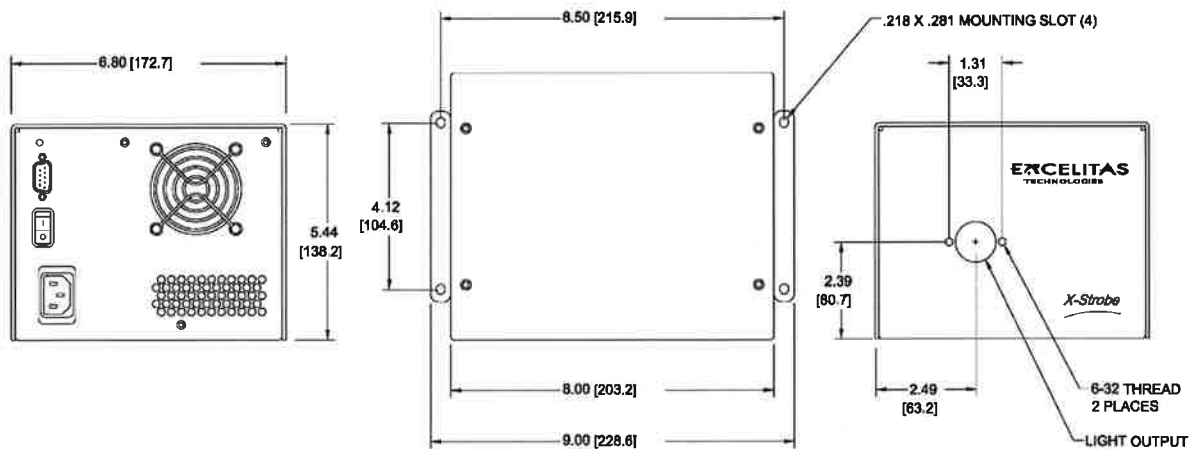

DIMENSIONS ARE IN INCHES (MILLIMETERS)

Figure 1. Outline and Mounting Dimensions

2.0 SPECIFICATION TABLES

Table 1: Optical Specifications	X1500	X1200	X400
Spectral bandwidth	250-1100+nm	250-1100+nm	250-1100+nm
Flash rate @ 600V**	16Hz max.	20 Hz max.	60 Hz max.
Fiber bundle outside diameter	1.0 inch (25 mm) max.		

*Approximate light output measured through a 1/2" aperture at the light output port (@600VDC).

** Flash rate is voltage dependent. [$f_{max} = 43/E$ and $Energy = 1/2 \text{ Capacitance} \times \text{Voltage}^2 (E = \frac{1}{2} CV^2)$]

Table 2: Electrical Specifications	X1500	X1200	X400
Input voltage	100-240 VAC $\pm 10\%$, 50/60Hz		
Maximum Output Power	43W		
Input Current (RMS)	1.5A @ 115 VAC		
Trigger input	+5V, 20mA, 10-100 μ sec pulse (into an opto-isolator with internal 150 ohms nominal series resistor)		
Flashlamp voltage (factory set)	500V		
Discharge capacitor	15 μ F	12 μ F	4 μ F
Input energy per flash @ 600V	2.70 joules	2.16 joules	0.72 joules
Delay between flash command and light output	10 μ sec (typ)		
Ext ref. Voltage*	3.5 to 6.0 volts dc ($V_0 = V_{ref} \times 100$)		

*-10 and -14 units have a 60 : 1 Vref ratio (5.8-10.0V) ($V_0 = V_{ref} \times 60$).

Table 3: Environmental Specifications

Operating temperature	0 to +40 °C (+32 to +104 °F)
Storage temperature	-40 to +95 °C (-40 to +194 °F)
Humidity	0% to 85% Non-Condensing



WARNING!

Because this product is only one component of a system, and, once sold is exclusively under the control of the user, it has the potential of being used in a manner outside the intended purpose of Excelitas Technologies Corp. design.



It is essential that the operating specifications and parameters described in Excelitas Technologies literature and those accompanying other manufacturer's components be observed and not be exceeded under any conditions.

To install or operate this product in a manner for which it is not intended may cause personal injury or **death**, as well as severe damage to the product and/or other system components.

3.0 INSTALLATION

3.1. MOUNTING

Four holes in the base of the X-Strobe™ Series enclosure are available for mounting the unit (see Figure 1). Mounting hardware is user-supplied. Position the unit so that the AC receptacle is accessible as a means of disconnect. Keep the air intake and exhaust areas at the rear of the unit free of obstructions. Provide sufficient space behind the unit to prevent recirculation of exhaust air.

3.2. SAFETY REQUIREMENTS

The X-Strobe™ has features related to safety, such as:

To prevent the possibility of injury from *flashlamp breakage*, leave either the **plastic cap plug** or a **fiber-optic cable** in place at all times. *Do not operate the unit with the cap plug in place.* See flashlamp replacement warning on page 10.

Use the **AC Receptacle** (on the right) as a disconnect device to remove any possibility of electrical input, particularly, when accessing the unit's interior.

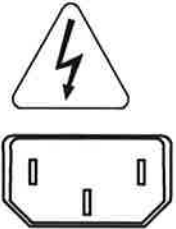

4.0 OPERATION

4.1. OUTPUT CONNECTIONS

Use a nosepiece (Table 4) or a nosepiece with adapter to connect a fiber-optic cable (Table 5) to the unit's light output port.* Position the cable to distribute light to the desired area.

Table 4: Nosepieces

TYPE	DESCRIPTION
MVS-22	Fostec Special 1" dia. Nosepiece
MVS-23	Fostec Standard 0.72" dia. Nosepiece
MVS-24	Volpi Standard 0.59" dia. Nosepiece
MVS-25	Dolan Jenner Standard 1.0" dia. Nosepiece (used with 1.0" O.D. Adapter)

Table 5: Fiber Optic Bundles
(by Excelitas Technologies Corp.)¹

TYPE	DESCRIPTION
MVS-7 Single	Illuminates a small area from one direction; 40 in. (102cm) long.
MVS-7D Dual	Reduces shadows by illuminating from two directions; 40 in. (102cm) long.
MVS-8 Ring Light	Illuminates an area of 2 in. with working distance of 4 in.; dependent on distance from light source and illumination plane; 36.5 in. (93cm) long.
MVS-12 Backlight ²	2x2 in. area; uniformity is ±5% over usable working area; 37 in. (94cm) long.
MVS-13 Backlight ²	4x5 in. area; uniformity is ±5% over usable working area; 37 in. (94cm) long.

¹See Excelitas Technologies Corp. Data Sheet, *Machine Vision Strobe, Fiber Optic Bundles*.

²Caution: High intensity may damage *PLASTIC* fiber optic bundles. Contact manufacturer for temperature limits and use IR filter to reduce heat.

*Note: Be sure to remove the safety cover from the output port before operating the unit.

4.2. INPUT CONNECTIONS

Use the input power cable supplied and connect to the IEC receptacle on the rear of the unit.

The 9-Pin D-Sub connector, J2, is used for trigger and Vref input. A female mating connector is supplied. Use a shielded cable, 90% coverage or better, 360 terminated to the back of the shell.

4.2.1. TRIGGER CONTROL

To trigger the strobe, a +5V TTL pulse (10-100 μsec, > 20 mA) is required. The strobe will flash on the rising edge of the pulse. A Trigger Test Module (MVS-105) at a fixed flash rate of 6 Hz is available through Excelitas Technologies to test the X-Strobe™. This module plugs into J2 and can be used to verify operation of the X-Strobe™.

4.2.2. Vref INPUT

The Vref input is used to externally control the intensity of the X-Strobe™. On standard units 4.0-6.0 Vdc reference voltage is connected to pin 3 (Vref) and pin 9 (Vref return). This results in a flash lamp voltage that is 100 times the reference voltage, or 400V to 600V ($V_{out} = V_{ref} \times 100$). On -10 and -14 units a 5.8 – 10.0 reference voltage is connected to pin 3 and pin 9. This resulted in a flash lamp voltage 60 times the reference.

In order for the Vref to be active, the SW3 slide switch must be set to EXT. This SW3 slide switch is located on the Power Supply inside the X-Strobe™. The X-Strobe™ is shipped with the SW3 set in the INT position. Changing SW3 requires opening the enclosure for internal access.

Please read the follow all safety precautions:

1. Switch off the unit and allow to cool.
2. Disconnect the AC power cord from the unit.
3. Wait at least 60 seconds to allow all capacitors to discharge.
4. Remove eight screws that hold on the cover, and remove the cover.
5. Be careful not to touch any components inside the unit.
6. SW3 is located on the main power supply at the top edge of the PC board. The silkscreen on the PC board indicates INT and EXT.
7. Place the cover on the unit and install the eight screws before reconnecting the AC power cord.

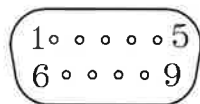

Figure 2: Signal Input Connector (J2)

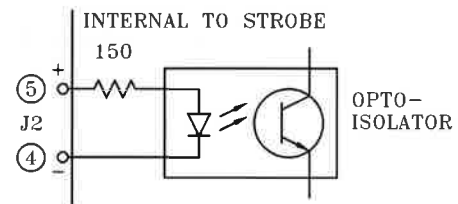

Figure 3: Input Trigger Circuit

Table 6: Signal Input Connector - J2

Pin 1	No connection
Pin 2	Internal Vref output
Pin 3	External Vref input
Pin 4	- Trigger: opto-isolator trigger return
Pin 5	+Trigger: opto-isolator trigger input;
Pin 6	No connection
Pin 7	Chassis ground
Pin 8	Chassis ground
Pin 9	Vref return

4.3. INTENSITY ADJUSTMENT (INTERNAL MODE)

The user can change the intensity of the strobe by adjusting a potentiometer through an opening in the rear of the case marked "INTERNAL V-REF ADJUST". Switch SW3 located on the edge of the main power supply PC board must be set to the INT position and the cover must be installed in order to use the X-Strobe™ internal adjustment.

By adjusting the internal pot using a small screwdriver, the user can vary the voltage on the main discharge capacitors from 400 VDC to 600 VDC. Rotating the POT clockwise increases the voltage. The intensity or energy per flash will vary as $\frac{1}{2}$ capacitance x (voltage)² (or $E = \frac{1}{2}CV^2$). The voltage has been factory set at 500 VDC. For reliable flashing over the life of the lamp, it is not recommended to operate the strobe at less than 400 VDC.

The actual output voltage setting (400-600 VDC) can be measured by monitoring the internal Vref setting (4.0-6.0 VDC) through the signal input connector J2. By disengaging the 9 pin D-connector, the user can measure the DC voltage between Pin 2 and Pin 9. The output voltage is 100 times the reference signal ($V_{out} = V_{ref} \times 100$). On -10 and -14 units ($V_{out} = V_{ref} \times 60$).

4.4. VOLTAGE SETTING VERSUS LAMP LIFE

Lamp life is dependent on the energy per flash. For maximum lamp life lower the lamp voltage to a minimum, that will allow sufficient light output for your application. However, for reliable flashing over the life of the lamp, it is not recommended to operate the strobe at less than 400 VDC.

5.0 MAINTENANCE



WARNING!

The X-Strobe™ Series strobe produces lethal voltages. Ensure that input power is disconnected and storage capacitors have been discharged before beginning any inspection

5.1. REPAIRS

The X-Strobe™ Series has no user servicable parts. No routine maintenance or repair is suggested, except for replacement of the flashlamp module.

In the event that the unit fails to operate properly (other than flashlamp replacement), it is strongly suggested that no attempt be made to troubleshoot. Field repairs and customer modifications are not authorized, and, if attempted, will void the warranty. Repairs must be made only by factory-trained personnel.

5.2. FLASHLAMP MODULE REPLACEMENT



WARNING!

The flashlamp is a high-pressure, gas-filled device. Wear safety glasses when replacing it. Avoid touching it with bare hands as fingerprints will burn into the glass and affect the life of the lamp.



Over a period of time (depending on usage), the xenon flashlamp may deteriorate and have to be replaced. The entire flashlamp-reflector module (P/N 302-9000) is to be replaced at the same time.

FLASHLAMP-REFLECTOR MODULE REMOVAL:

1. Switch off the unit and allow to cool.
2. Disconnect the AC power cord from the unit.
3. Wait at least 60 seconds to allow all capacitors to discharge.
4. Remove eight screws that hold on the cover, and remove the cover.
5. Be careful not to touch any components inside the unit.
6. Remove the two screws that secure the flashlamp PC board to the capacitor PC board.
7. Carefully lift the flashlamp PC board out of the unit.
8. Unplug the connector from the rear of the flashlamp PC board.
(Twisted brown/orange J103).
9. Unscrew the acorn nut that secures the lamp-reflector module to the flashlamp PC board and remove the lamp-reflector module.
Note: The lamp is simply placed inside the reflector - it is not attached to the reflector.
10. Disconnect the flashlamp cathode lead from J100.

FLASHLAMP-REFLECTOR MODULE INSTALLATION:

1. Unscrew the acorn nut from the new flashlamp, discard the spacer, but keep the flashlamp inside the reflector. Taking care not to touch the flashlamp or the inside of the reflector.
2. Insert the threaded lug of the flashlamp into the flashlamp PC board matching the "D-shape" of the lamp with the "D-shape" of the hole.
3. Secure the lamp-reflector module to the PC board with the acorn nut.
4. Connect the new flashlamp cathode lead to J100.
5. Plug in the connector to the rear of the flashlamp PC board.
(Twisted brown/orange J103.)
6. Carefully insert the flashlamp PC board into the two slots in the bottom of the unit.
7. Install the two screws to the two standoffs on the capacitor PC board.
8. Place the cover on the unit and install the eight screws before reconnecting the AC power cord.

5.3. CLEANING

After disconnecting power from the unit, clean with a soft cloth dampened with a mild, non-abrasive cleaner and wipe dry. *Never immerse the unit in water or any other liquid.* Cover light output port before cleaning.

5.4. REPACKING AND STORAGE

If the X-Strobe™ Series strobe is to be stored for a prolonged period, shipped to another location, or returned to the factory for repair, it should be repacked in the original packaging material. If this material has been discarded, the unit should be repacked so as to prevent movement within the container and damage from improper handling. A storage area should be dry, at a temperature of 40 °C to +90 °C (-40 °F to +194 °F).

6.0 DECLARATION OF CONFORMITY

MANUFACTURER:

Excelitas Technologies Corp.
35 Congress Street
Salem, Massachusetts 01970 U.S.A.

EUROPEAN REPRESENTATIVE

Excelitas Technologies GmbH:
Wenzel-Jaksch-Str. 31
D-65199 Wiesbaden Germany

Part Number	Model Number	Product Description
302-9004	X-Strobe X400	Machine Vision Strobe (60Hz, 4uF, 600V)
302-9004-04	X-Strobe X400-04	
302-9004-10	X-Strobe X400-10	
302-9004-14	X-Strobe X400-14	
302-9012	X-Strobe X1200	Machine Vision Strobe (20Hz, 12uF, 600V)
302-9012-04	X-Strobe X1200-04	
302-9012-05	X-Strobe X1200-05	
302-9012-10	X-Strobe X1200-10	
302-9012-14	X-Strobe X1200-14	
*302-9012-15	X-Strobe X1200-15	
302-9015	X-Strobe X1500	Machine Vision Strobe (16Hz, 15uF, 600V)
302-9015-04	X-Strobe X1500-04	
302-9015-10	X-Strobe X1500-10	

* This product is a custom product for VISTEC. Once safety panel is removed they will maintain CE.

We, Excelitas Technologies Corp., at 35 Congress Street, Salem, Massachusetts, U.S.A., declare that the product described above is in conformity with **EU EMC Directive 89/336/EEC Essential Health and Safety Requirements Relating to Electromagnetic Compatibility** using the relevant sections of the following standards and other normative documents:

- EN55011 (1991) Class A, Group 1
Radiated and Conducted Electronic Emissions for Industrial, Scientific, and Medical Equipment
- EN61000-4-2 (1996)
Electrostatic Discharge Immunity
- EN61000-4-3 (1997) / ENV 50204 (1996)
Radiated Electromagnetic Field Immunity
- EN61000-4-4 (1995)
Electric Fast Transient Burst Immunity
- EN61000-4-5 (1995)
Surge Immunity
- EN61000-4-6 (1995)
Radio-Frequency Common Mode Immunity
- EN61000-4-11 (1994)
Voltage Dip and Interrupt Immunity

This product also complies with **EU Low Voltage Directive 73/23/EEC** using the relevant sections of the following standards and other normative documents:

- EN61010-1: 2001
Safety requirements for electrical equipment for measurement, controls and laboratory use.

This product has been manufactured in compliance with Excelitas Technologies Corp. I.S. EN ISO 9001: 2008, Quality System, Registration Number M1312.

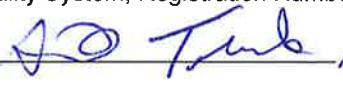
Stewart Tuttle, Quality Assurance