

DM74ALS125 Quad 3-STATE Buffer

General Description

This device contains four independent gates each of which performs a non-inverting buffer function. The outputs have the 3-STATE feature. The 3-STATE circuitry contains a feature that maintains the buffer outputs in 3-STATE (high impedance state) during power supply ramp-up or ramp-down. This eliminates bus glitching problems that arise during power-up and power-down. To minimize the possibility that two outputs will attempt to take a common bus to opposite logic levels, the disable time is shorter than the enable time of the outputs.

Features

- Advanced low power oxide-isolated ion-implanted Schottky TTL process
- Functional and pin compatible with the 74LS counterpart
- Switching response specified into 500Ω and 50 pF load
- Switching response specifications guaranteed over full temperature and V_{CC} supply range
- PNP input design reduces input loading
- Low level drive current: 74ALS = 24 mA

Connection Diagram

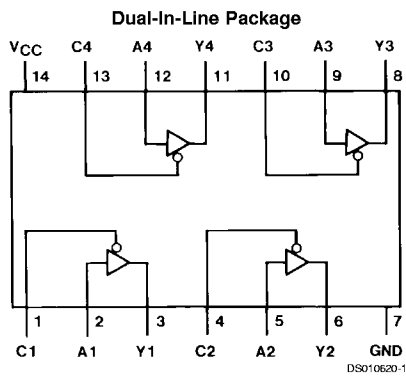

Order Number
DM74ALS125N or DM74ALS125M
See Package Number M14A or N14A

Functional Table

Y = A

Input		Output
A	C	Y
L	L	L
H	L	H
X	H	Hi-Z

H = High Logic Level
L = Low Logic Level
X = Either Low or High Logic Level
Hi-Z = 3-STATE (Outputs are disabled)

Absolute Maximum Ratings (Note 1)

Supply Voltage, V_{CC}	7V
Input Voltage	7V
Voltage Applied to Disabled Output	5.5V
Operating Free Air Temperature Range	0 to +70°C
DM74ALS	

Storage Temperature Range -65°C to +150°C

Typical θ_{JA}	
N Package	78.0°C/W
M Package	111.0°C/W

Recommended Operating Conditions

Symbol	Parameter	DM74ALS125			Units
		Min	Typ	Max	
V_{CC}	Supply Voltage	4.5	5	5.5	V
V_{IH}	High Level Input Voltage	2			V
V_{IL}	Low Level Input Voltage			0.8	V
I_{OH}	High Level Output Current			-15	mA
I_{OL}	Low Level Output Current			24	mA
T_A	Operating Free-Air Temperature	0		70	°C

Note 1: The "Absolute Maximum Ratings" are those values beyond which the safety of the device cannot be guaranteed. The device should not be operated at these limits. The parametric values defined in the "Electrical Characteristics" table are not guaranteed at the absolute maximum ratings. The "Recommended Operating Conditions" table will define the conditions for actual device operation.

Electrical Characteristics

over recommended operating free air temperature (unless otherwise specified)

Symbol	Parameter	Conditions	DM74ALS125			Units
			Min	Typ	Max	
V_{IK}	Input Clamp Voltage	$V_{CC} = 4.5V, I_I = -18\text{ mA}$			-1.5	V
V_{OH}	High Level Output Voltage	$V_{CC} = 4.5V\text{ to }5.5V$	$I_{OH} = -0.4\text{ mA}$	$V_{CC} - 2$		V
		$V_{CC} = 4.5V$	$I_{OH} = -3\text{ mA}$	2.4		V
			$I_{OH} = \text{Max}$	2		V
V_{OL}	Low Level Output Voltage	$V_{CC} = 4.5V$	$I_{OL} = 12\text{ mA}$	0.25	0.4	V
			$I_{OL} = 24\text{ mA}$	0.35	0.5	V
I_I	Input Current at Max Input Voltage	$V_{CC} = 5.5V, V_I = 7V$			0.1	mA
I_{IH}	High Level Input Current	$V_{CC} = 5.5V, V_I = 2.7V$			20	μA
I_{IL}	Low Level Input Current	$V_{CC} = 5.5V, V_{IL} = 0.4V$			-0.1	mA
I_O	Output Drive Current	$V_{CC} = 5.5V, V_O = 2.25V$	-30		-112	mA
I_{OZH}	High Level 3-STATE Output Current	$V_{CC} = 5.5V, V_O = 2.7V$			20	μA
I_{OZL}	Low Level 3-STATE Output Current	$V_{CC} = 5.5V, V_O = 0.4V$			-20	μA
I_{CC}	Supply Current	$V_{CC} = 5.5V$	Outputs High	7	10	mA
			Outputs Low	10	14	mA
			3-STATE	13.5	18	mA

Switching Characteristics

over recommended operating free-air temperature range (Note 2)

Symbol	Parameter	From (Input)	To (Output)	Conditions	DM74ALS125		Units
					Min	Max	
t_{PLH}	Propagation Delay Time Low to High Level Output	A	Y	$V_{CC} = 4.5V$ to $5.5V$, $C_L = 50$ pF, $R1 = 500\Omega$, $R2 = 500\Omega$, $T_A = \text{Min to Max}$	3	10	ns
t_{PHL}	Propagation Delay Time High to Low Level Output	A	Y		2	10	ns
t_{PZH}	Output Enable Time to High Level Output	C	Y		2	13	ns
t_{PZL}	Output Enable Time to Low Level Output	C	Y		2	12	ns
t_{PHZ}	Output Disable Time from High Level Output	C	Y		1	8	ns
t_{PLZ}	Output Disable Time from Low Level Output	C	Y		2	13	ns

Note 2: See Section 1 for test waveforms and output load.

Logic Diagram

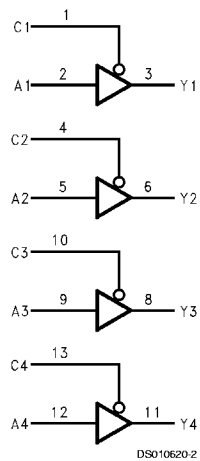

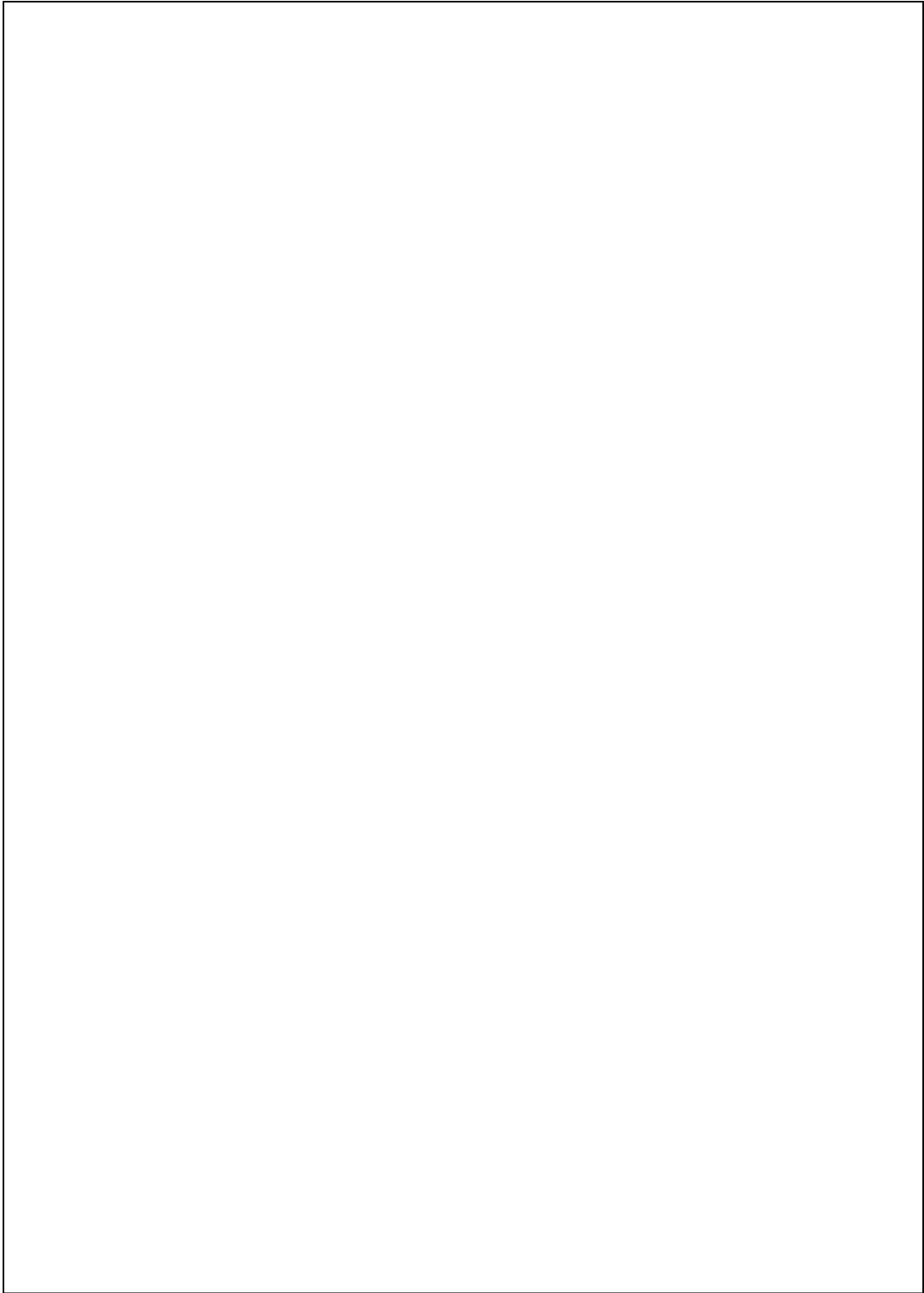

Physical Dimensions inches (millimeters) unless otherwise noted

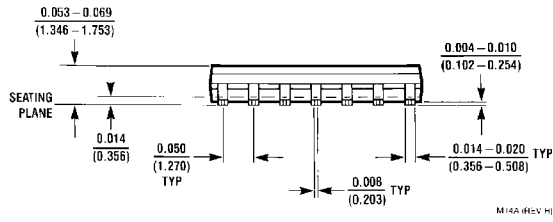
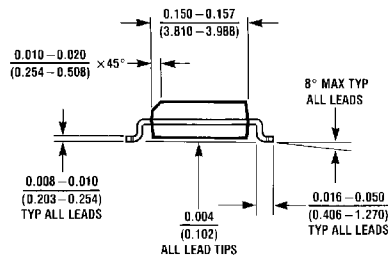
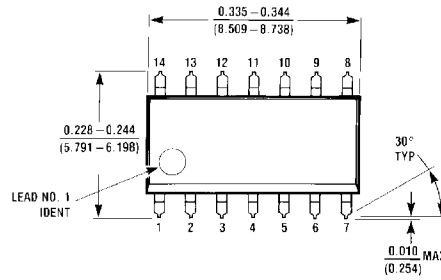

M14A (REV. H)

Small Outline Package (M)
Order Number 74ALS125M
Package Number M14A

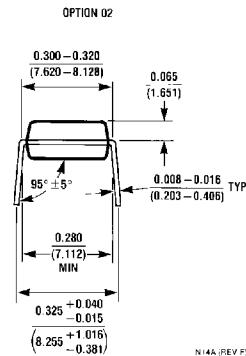
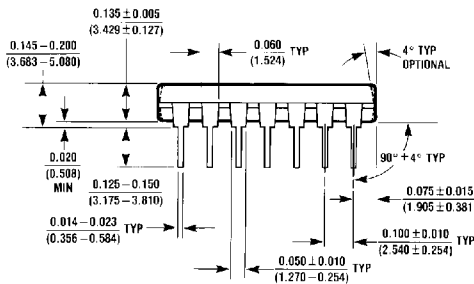
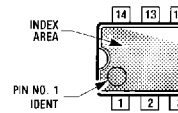
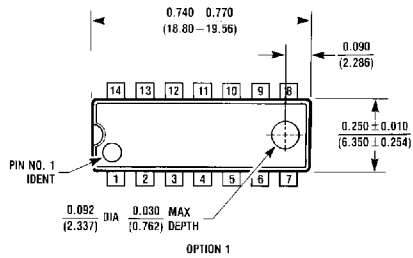

N14A (REV. F)

Molded Dual-In-Line Package (N)
Order Number 74ALS125N
Package Number N14A