

SPECIFICATION

BHS2612-11S-08H06 LF

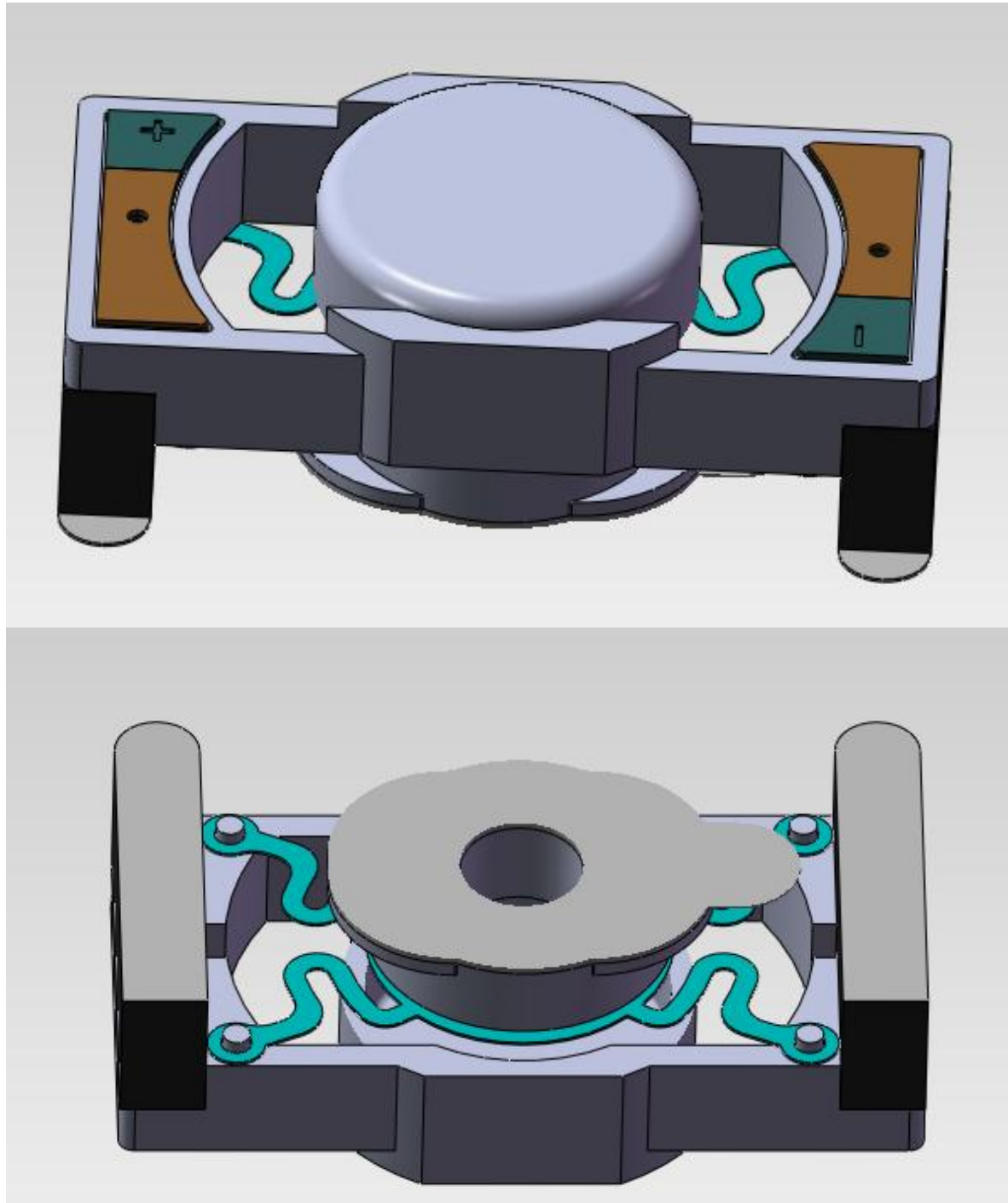



SPECIFICATION FOR DYNAMIC LOUDSPEAKER

TOTAL PAGE

8

www.bestargroups.com

RoHS

Preliminary Specification

Customer		Model Name	BHS2612-11S-08H06 LF
Customer P/N		Product No.	260102
Date	Mar22.16	Issue No.	BS/TES01.1280A
Page	02 of 08	Issue Date	2016/03/22

Approval:

- 1.Characteristics
- 2.Drawing
- 3.Reliability Test
- 4.Packing
- 5.History Change Record

Drawn by	Checked by	Approved by	Customer approved
魏春欢	汪凤声	徐金国	

BESTAR HOLDING CO.,LTD

No.199 HuangHe West Road,New district,ChangZhou,JiangSu Province,P.R.China

Tel: +86 519 88222567

Fax: +86 519 88222551

E-mail:wu@be-star.com

<http://www.bestargroups.com>

BHS2612-11S-08H06 LF



1.Characteristics

1.1 Electrical and Mechanical Characteristics

No.	Item	Specification
1.	Dimension	26 ×12×6 (mm)
2.	AC Impedance	8 Ω ± 20%(at 1KHz)
3.	Rated Input Power	1W
4.	Maximum Input Power	2W
5.	Resonance Frequency	500Hz ±20%
6.	Frequency Response	F0~15KHz
7.	THD (1w/0.1m)	≤5% (at 1KHz/1W)
8.	Buzzes & Rattles	Must be normal at sine wave 2.83Vrms
9.	Polarity	Positive voltage to (+),Diaphragm moves forward
10.	Operating Temperature	- 40~+ 85°C
11.	Storage Temperature	-40~+85 °C

1.2 Test Method

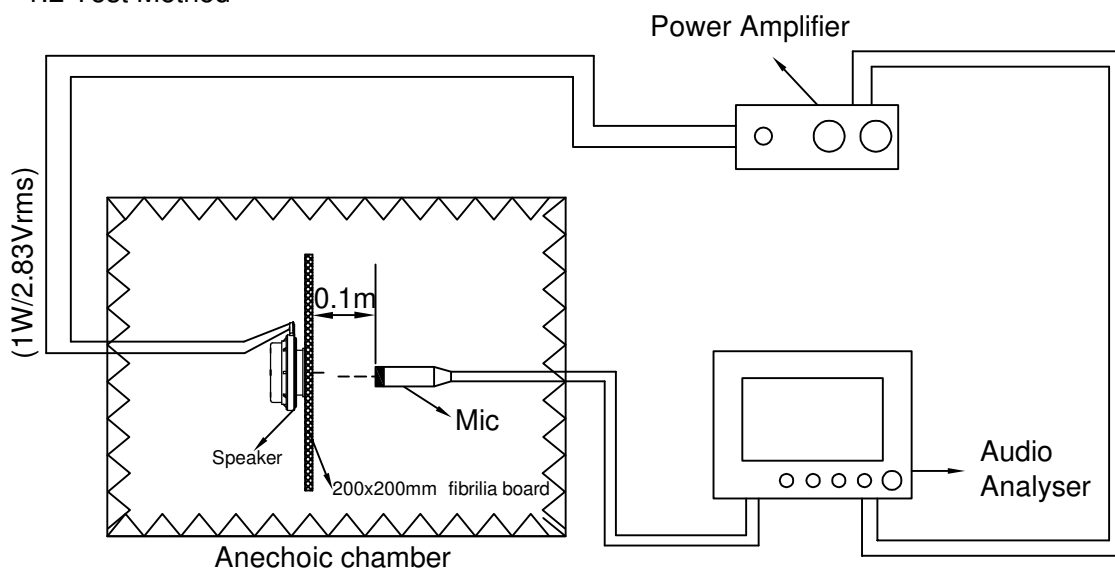

Date: 2016/03/22

BHS2612-11S-08H06 LF

Drawn by: 魏春欢

Checked by: 汪风声

Approved by: 徐金国

Speaker

BESTAR HOLDING CO.,LTD

www.bestargroups.com wu@be-star.com

DRG NO: BS/TES01.1280A

Page:03 of 08

BHS2612-11S-08H06 LF

1.3 Impedance Curve (only for reference)

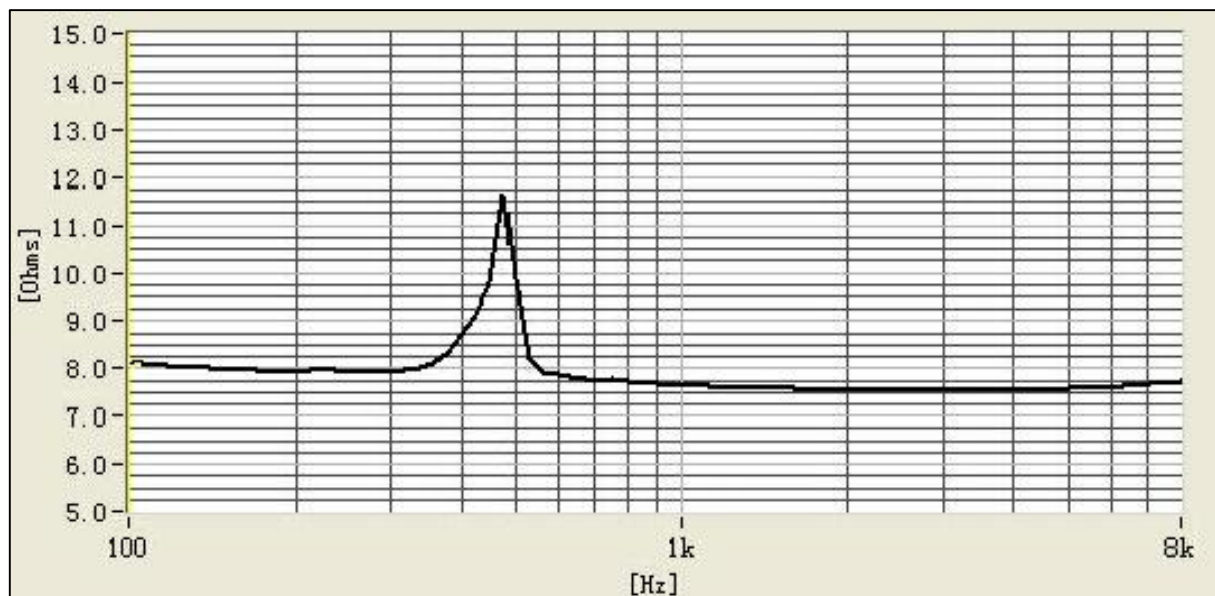

1.4 Total Harmonic Distortion Curve (only for reference)

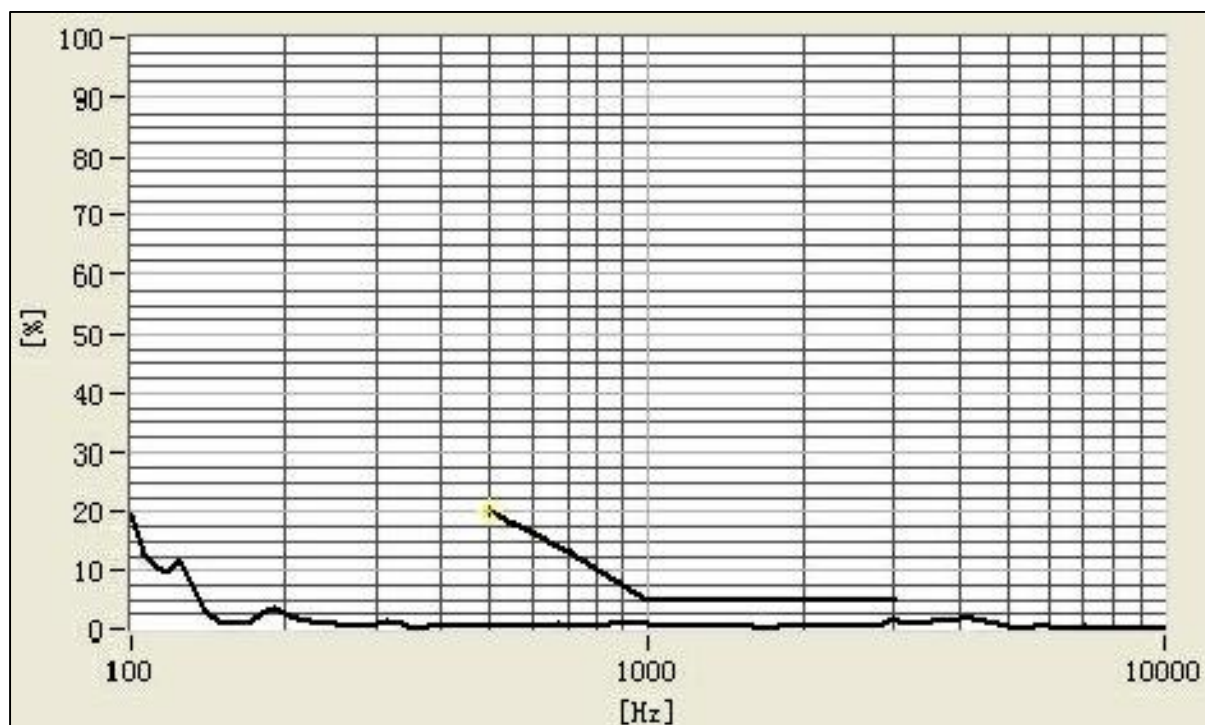

This print and information there in are proprietary to BeStar Holding Co., Ltd. and shall not be used in whole or in part without its written content

				Date:	2016/03/22	BHS2612-11S-08H06 LF
				Drawn by:	魏春欢	
A	2016/03/22	魏春欢		Checked by:	汪风声	Speaker
Rev.	Date	Drawn	Note	Approved by:	徐金国	
BESTAR HOLDING CO.,LTD						DRG NO: BS/TES01.1280A
www.bestargroups.com wu@be-star.com						Page:04 of 08

BHS2612-11S-08H06 LF

2.Drawing

unit:mm
tolerance:±0.2

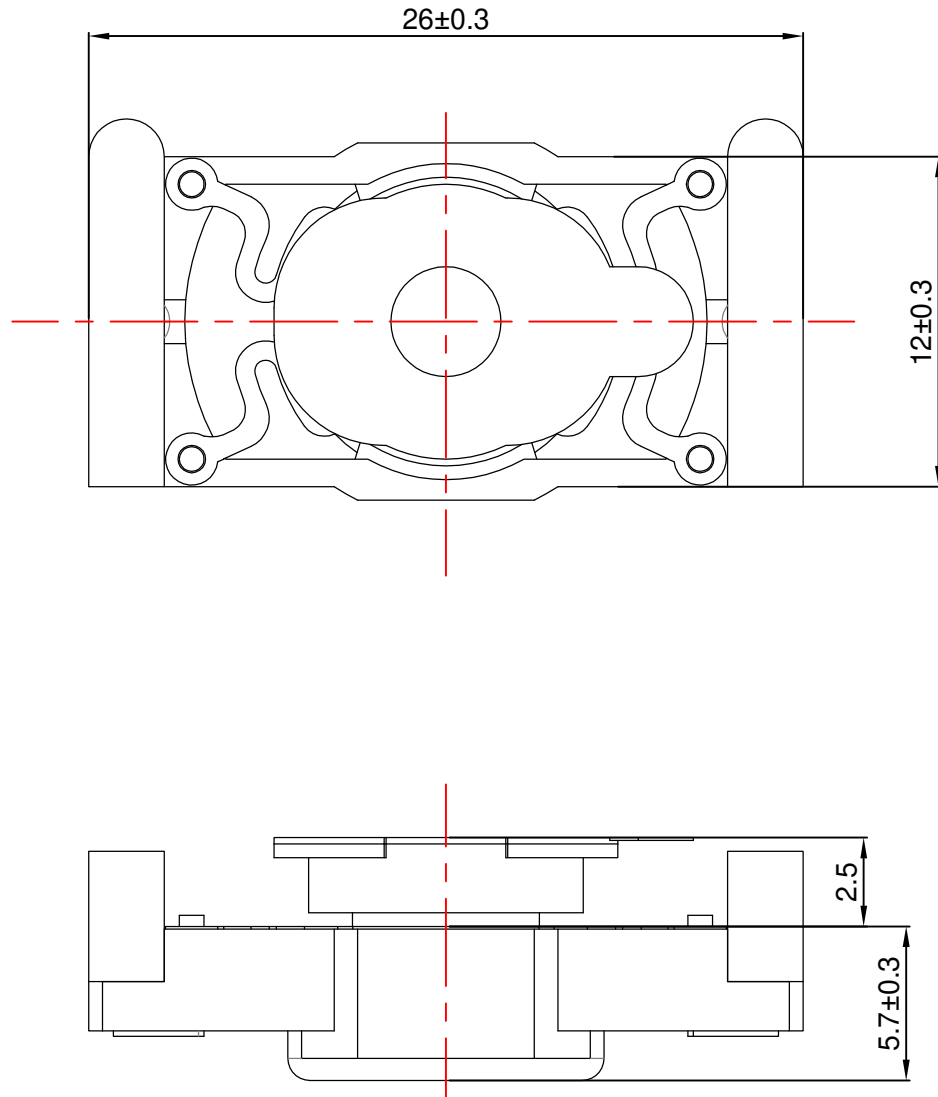

This print and information there in are proprietary to BeStar Holding Co., Ltd. and shall not be used in whole or in part without its written content

				Date:	2016/03/22	BHS2612-11S-08H06 LF	
				Drawn by:	魏春欢		
A	2016/03/22	魏春欢		Checked by:	汪风声	Speaker	
Rev.	Date	Drawn	Note	Approved by:	徐金国		
BESTAR HOLDING CO.,LTD						DRG NO: BS/TES01.1280A	Page:05 of 08
www.bestargroups.com wu@be-star.com							

BHS2612-11S-08H06 LF

3. Reliability Test

3.1 Load Test

Power (Nom)
Duration

1W(white noise)
96hrs

3.2 High Temperature Test

Temperature
Duration

+85±2°C
96hrs

3.3 Low Temperature Test

Temperature
Duration

-40±2°C
96hrs

3.4 Damp Heat

Temperature
Relative Humidity
Duration

40±2°C
90%-95%RH
96hrs

3.5 Temperature change(shock)

Low Temperature
High Temperature
Dwell time each temperature
Transfer time from lower to upper temperature
Cycles

-40± 3°C
+85± 3°C
30min
<10s
96

This print and information there in are propriety to BeStar Holding Co., Ltd. and shall not be used in whole or in part without its written content

				Date:	2016/03/22	BHS2612-11S-08H06 LF
				Drawn by:	魏春欢	
A	2016/03/22	魏春欢		Checked by:	汪风声	Speaker
Rev.	Date	Drawn	Note	Approved by:	徐金国	
BESTAR HOLDING CO.,LTD					www.bestargroups.com	DRG NO: BS/TES01.1280A
					wu@be-star.com	Page:06 of 08

BHS2612-11S-08H06 LF

4. Packing

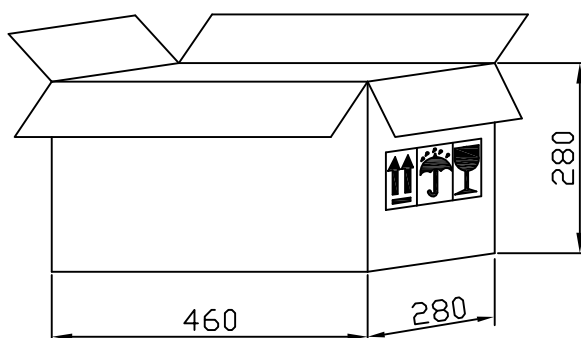
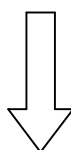
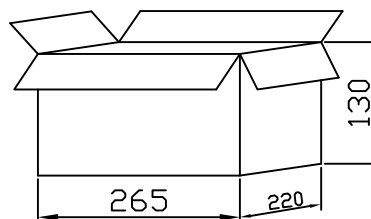
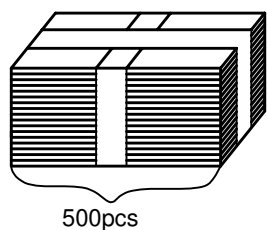
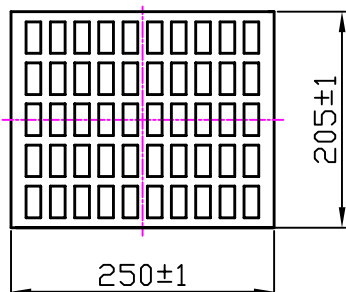

Remark:
 50 pcs per tray
 10 trays for unit
 500 pcs per carton
 4 cartons per box
 Total 2000 pcs per box
 Size: 44×28×28(cm)

This print and information there in are proprietary to BeStar Holding Co., Ltd. and shall not be used in whole or in part without its written content.

				Date:	2016/03/22	BHS2612-11S-08H06 LF	
				Drawn by:	魏春欢		
A	2016/03/22	魏春欢		Checked by:	汪风声	Speaker	
Rev.	Date	Drawn	Note	Approved by:	徐金国		
BESTAR HOLDING CO.,LTD						DRG NO: BS/TES01.1280A	Page:07 of 08
www.bestargroups.com wu@be-star.com							

