

3A Low Dropout Linear Regulator

Features

- Low Dropout Voltage: Typical 1.3V at 3A
- Current Limiting and Thermal Protection
- Output Current: 3A
- Current Limit: 4.5A
- Operating Junction Temperature: 0 to 125°C
- Line Regulation: 0.015% (Typical)
- Load Regulation: 0.1% (Typical)
- Available in RoHS Compliant, Lead Free Packaging

TO-220

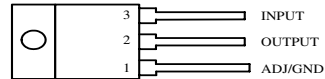

Applications

- High Efficiency Linear Regulators
- Battery Charger
- Post Regulation for Switching Supplies
- Microprocessor Supply
- Mother Board Power Supplies
- DVD - Video Player
- Telecom Equipment
- Set Top Boxes and Web Box Modular Supplies

General Description

The SP1085 is a series of low dropout positive voltage regulators with a maximum dropout of 1.5V at 3A of load current. The series features on-chip thermal shutdown. It also includes a bandgap reference and a current limiting circuit. The SP1085 is available in 1.5V, 1.8V, 2.5V, 2.85V, 3.3V, 5.0V and adjustable versions. The fixed versions integrate the adjust resistors. The adjustable version can set the output voltage with two external resistors. The SP1085 series is available in standard packages of TO-263-3L, TO-220 and TO-252.

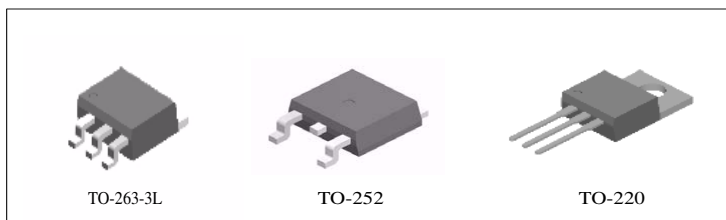

Figure 1. Package Types of SP1085

Pin Configuration

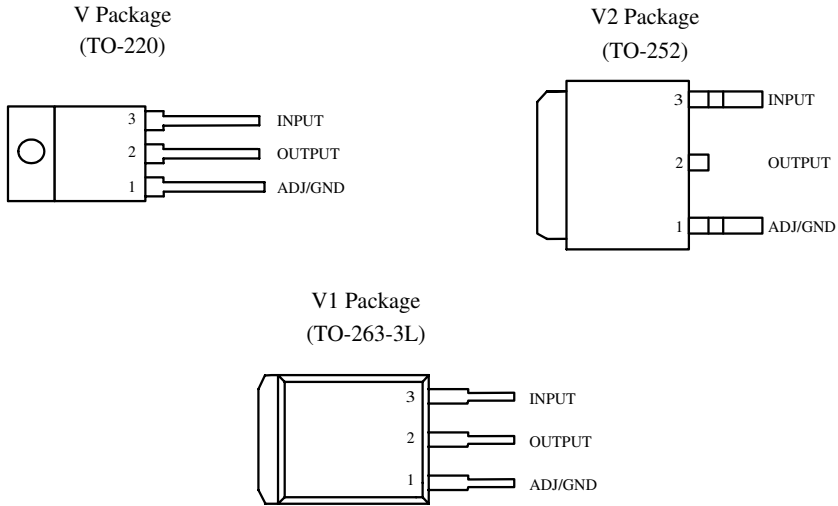

Figure 2. Pin Configuration of SP1085 (Top View)

Functional Block Diagram

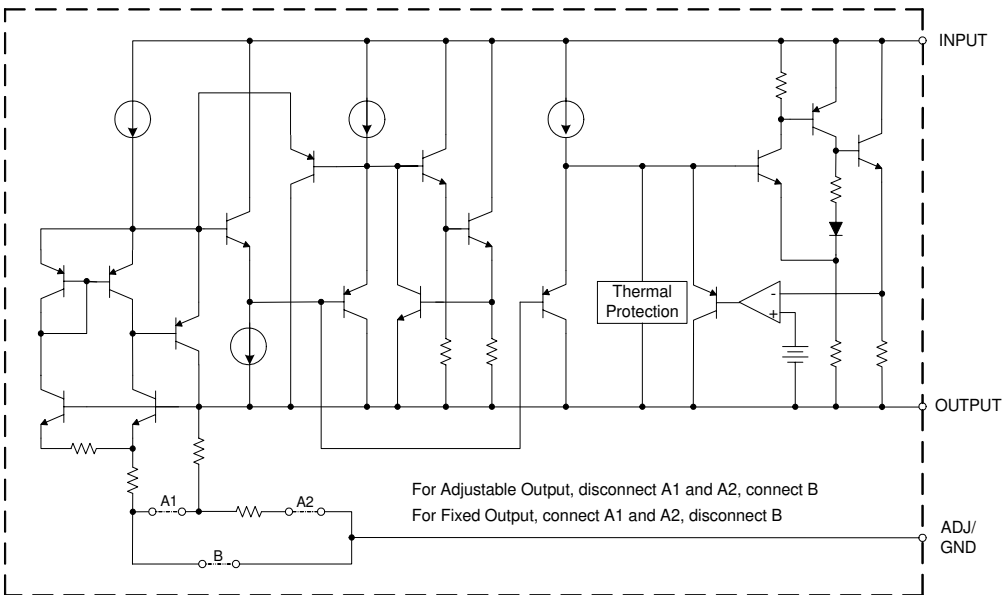

Figure 3. Functional Block Diagram of SP1085

Absolute Maximum Ratings (Note 1)

Parameter	Symbol	Min	Max	Unit
Operating Junction Temperature	T_J		150	°C
Storage Temperature	T_S	-65	150	°C
Lead Temperature (Soldering, 10 sec.)	T_{LEAD}		300	°C
ESD (Human Body Model)	ESD		2000	V

Note 1: Stresses greater than those listed under "Absolute Maximum Ratings" may cause permanent damage to the device. These are stress ratings only, and functional operation of the device at these or any other conditions beyond those indicated under "Recommended Operating Conditions" is not implied. Exposure to "Absolute Maximum Ratings" for extended periods may affect device reliability.

Recommended Operating Conditions

Parameter	Symbol	Min	Max	Unit
Input Voltage	V_{IN}		12	V
Operating Junction Temperature Range	T_J	0	125	°C

Electrical Characteristics

Typicals and limits appearing in normal type apply for $T_J = 25^\circ\text{C}$. Limits appearing in **Boldface** type apply over the entire operating junction temperature range 0 to 125°C .

Parameter	Symbol	Conditions	Min	Typ	Max	Unit
Reference Voltage	V_{REF}	SP1085-ADJ, $I_{OUT}=10\text{mA}$, $V_{IN} - V_{OUT} = 3\text{V}$, $T_J = 25^\circ\text{C}$, $10\text{mA} \leq I_{OUT} \leq 3\text{A}$, $1.5\text{V} \leq V_{IN} - V_{OUT} \leq 5\text{V}$	1.238 1.225	1.250 1.250	1.262 1.275	V
Output Voltage	V_{OUT}	SP1085-1.5, $I_{OUT}=0\text{mA}$, $V_{IN} = 4.5\text{V}$, $T_J = 25^\circ\text{C}$, $10\text{mA} \leq I_{OUT} \leq 3\text{A}$, $3.1\text{V} \leq V_{IN} \leq 6\text{V}$	1.485 1.47	1.5 1.5	1.515 1.53	V
		SP1085-1.8, $I_{OUT} = 0\text{mA}$, $V_{IN} = 4.8\text{V}$, $T_J = 25^\circ\text{C}$, $10\text{mA} \leq I_{OUT} \leq 3\text{A}$, $3.4\text{V} \leq V_{IN} \leq 7\text{V}$	1.782 1.764	1.8 1.8	1.818 1.836	V
		SP1085-2.5, $I_{OUT} = 0\text{mA}$, $V_{IN} = 5.5\text{V}$, $T_J = 25^\circ\text{C}$, $10\text{mA} \leq I_{OUT} \leq 3\text{A}$, $4.1\text{V} \leq V_{IN} \leq 7\text{V}$	2.475 2.45	2.5 2.5	2.525 2.55	V
		SP1085-2.85, $I_{OUT} = 0\text{mA}$, $V_{IN} = 6\text{V}$, $T_J = 25^\circ\text{C}$, $10\text{mA} \leq I_{OUT} \leq 3\text{A}$, $4.5\text{V} \leq V_{IN} \leq 8\text{V}$	2.821 2.793	2.85 2.85	2.879 2.907	V
		SP1085-3.3, $I_{OUT} = 0\text{mA}$, $V_{IN} = 6.3\text{V}$, $T_J = 25^\circ\text{C}$, $10\text{mA} \leq I_{OUT} \leq 3\text{A}$, $4.9\text{V} \leq V_{IN} \leq 8\text{V}$	3.267 3.234	3.3 3.3	3.333 3.366	V
		SP1085-5.0, $I_{OUT} = 0\text{mA}$, $V_{IN} = 8\text{V}$, $T_J = 25^\circ\text{C}$, $10\text{mA} \leq I_{OUT} \leq 3\text{A}$, $6.6\text{V} \leq V_{IN} \leq 10\text{V}$	4.95 4.9	5 5	5.05 5.1	V
Line Regulation	ΔV_{OUT}	SP1085-ADJ, $I_{OUT} = 10\text{mA}$, $2.85\text{V} \leq V_{IN} \leq 10\text{V}$		0.015 0.035	0.2 0.2	%
		SP1085-1.5, $I_{OUT} = 10\text{mA}$, $3.1\text{V} \leq V_{IN} \leq 10\text{V}$		0.5 1	6 6	mV
		SP1085-1.8, $I_{OUT} = 10\text{mA}$, $3.4\text{V} \leq V_{IN} \leq 10\text{V}$		0.5 1	6 6	mV
		SP1085-2.5, $I_{OUT} = 10\text{mA}$, $4.1\text{V} \leq V_{IN} \leq 10\text{V}$		0.5 1	6 6	mV
		SP1085-2.85, $I_{OUT} = 10\text{mA}$, $4.5\text{V} \leq V_{IN} \leq 10\text{V}$		0.5 1	6 6	mV
		SP1085-3.3, $I_{OUT} = 10\text{mA}$, $4.9\text{V} \leq V_{IN} \leq 10\text{V}$		0.5 1	6 6	mV

Electrical Characteristics (Continued)

Typicals and limits appearing in normal type apply for $T_J = 25^\circ\text{C}$. Limits appearing in **Boldface** type apply over the entire operating junction temperature range 0 to 125°C .

Parameter	Symbol	Conditions	Min	Typ	Max	Unit
		SP1085-5.0, $I_{\text{OUT}} = 10\text{mA}$, $6.6\text{V} \leq V_{\text{IN}} \leq 10\text{V}$		0.5 1	10 10	mV
Load Regulation	ΔV_{OUT}	SP1085-ADJ, $0\text{mA} \leq I_{\text{OUT}} \leq 3\text{A}$, $V_{\text{IN}} - V_{\text{OUT}} = 3\text{V}$		0.1 0.2	0.3 0.4	%
		SP1085-1.5, $0\text{mA} \leq I_{\text{OUT}} \leq 3\text{A}$, $V_{\text{IN}} - V_{\text{OUT}} = 3\text{V}$		3 7	15 20	mV
		SP1085-1.8, $0\text{mA} \leq I_{\text{OUT}} \leq 3\text{A}$, $V_{\text{IN}} - V_{\text{OUT}} = 3\text{V}$		3 7	15 20	mV
		SP1085-2.5, $0\text{mA} \leq I_{\text{OUT}} \leq 3\text{A}$, $V_{\text{IN}} - V_{\text{OUT}} = 3\text{V}$		3 7	15 20	mV
		SP1085-2.85, $0\text{mA} \leq I_{\text{OUT}} \leq 3\text{A}$, $V_{\text{IN}} - V_{\text{OUT}} = 3\text{V}$		3 7	15 20	mV
		SP1085-3.3, $0\text{mA} \leq I_{\text{OUT}} \leq 3\text{A}$, $V_{\text{IN}} - V_{\text{OUT}} = 3\text{V}$		3 7	15 20	mV
		SP1085-5.0, $0\text{mA} \leq I_{\text{OUT}} \leq 3\text{A}$, $V_{\text{IN}} - V_{\text{OUT}} = 3\text{V}$		5 10	20 35	mV
Dropout Voltage		$I_{\text{O}} = 3\text{A}$, ΔV_{REF} , $\Delta V_{\text{OUT}} = 1\%$		1.3	1.5	V
Current Limit	I_{LIMIT}	$V_{\text{IN}} - V_{\text{OUT}} = 3\text{V}$,	3.2	4.5		A
Minimum Load Current		$V_{\text{IN}} = 10\text{V}$ (SP1085-ADJ)		3	10	mA
Quiescent Current		$V_{\text{IN}} = 10\text{V}$ (SP1085)		5	10	mA
Ripple Rejection		$f_{\text{RIPPLE}} = 120\text{Hz}$, $C_{\text{OUT}} = 25\mu\text{F}$ Tantalum, $I_{\text{OUT}} = 3\text{A}$, $V_{\text{IN}} - V_{\text{OUT}} = 3\text{V}$	60	72		dB
Adjust Pin Current		$V_{\text{IN}} = 4.25\text{V}$, $I_{\text{OUT}} = 10\text{mA}$		55	120	μA
Adjust Pin Current Change		$10\text{mA} \leq I_{\text{OUT}} \leq 3\text{A}$, $1.5\text{V} \leq V_{\text{IN}} - V_{\text{OUT}} \leq 6\text{V}$		0.2	5	μA
Long Term Stability		$T_A = 125^\circ\text{C}$, 1000Hrs		0.5		%
Temperature Stability		$I_{\text{OUT}} = 10\text{mA}$, $V_{\text{IN}} - V_{\text{OUT}} = 1.5\text{V}$		0.5		%
RMS Noise (% of V_{OUT})		$T_A = 25^\circ\text{C}$, $10\text{Hz} \leq f \leq 10\text{kHz}$		0.003		%
Thermal Resistance Junction-to-Case	θ_{JC}	TO-263 TO-220 TO-252		3 3 4		$^\circ\text{C} / \text{W}$

Typical Performance Characteristics

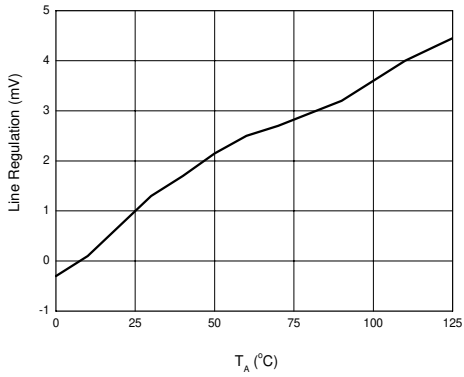

Figure 4. Line Regulation vs. Temperature

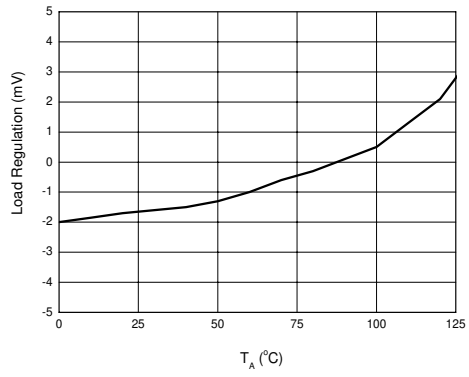

Figure 5. Load Regulation vs. Temperature

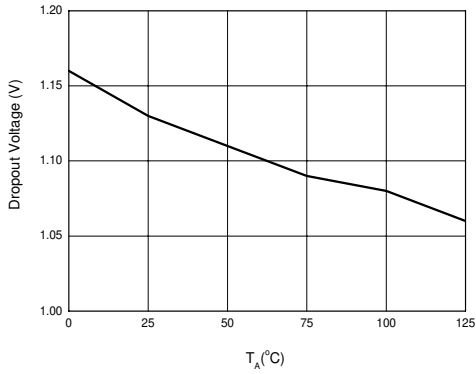

Figure 6. Dropout Voltage vs. Temperature

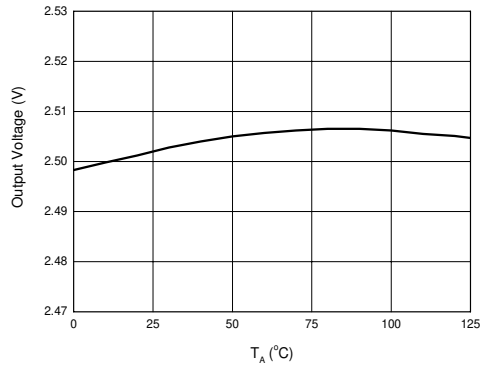

Figure 7. Output Voltage vs. Temperature

Typical Performance Characteristics (Continued)

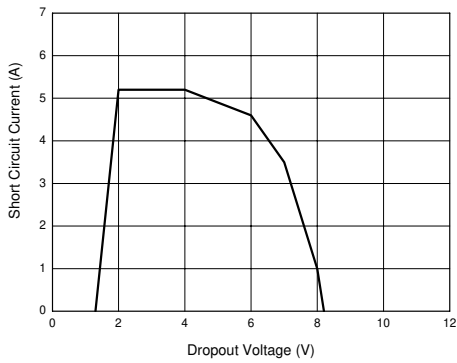

Figure 8. Short Circuit Current vs. Dropout Voltage

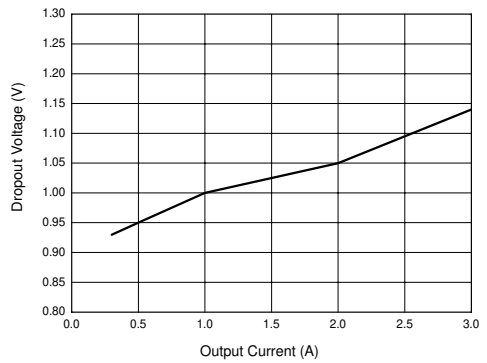

Figure 9. Dropout Voltage vs. Output Current

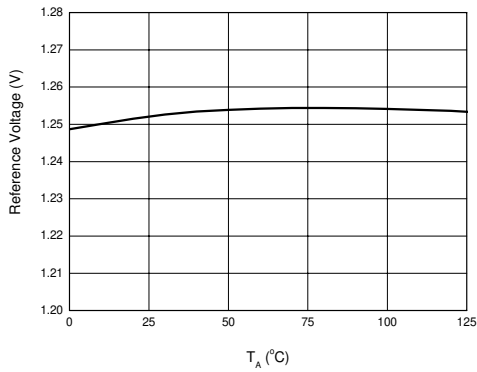

Figure 10. Reference Voltage vs. Temperature

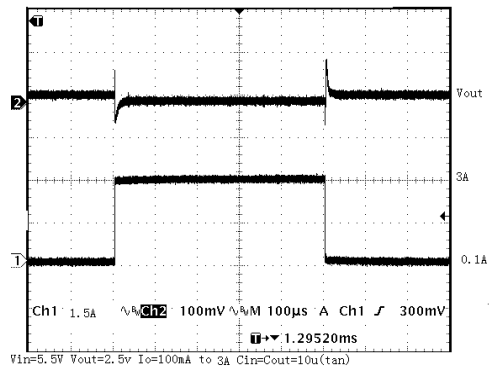

Figure 11. Load Transient Response

Typical Performance Characteristics (Continued)

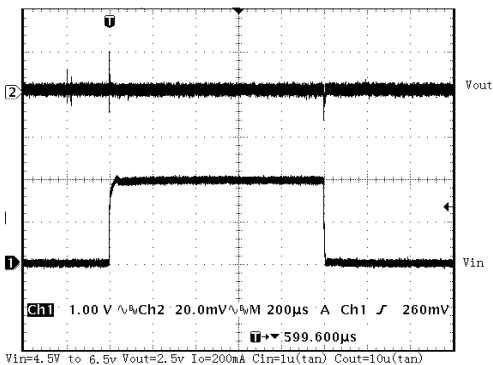

Figure 12. Line Transient Response

Typical Application

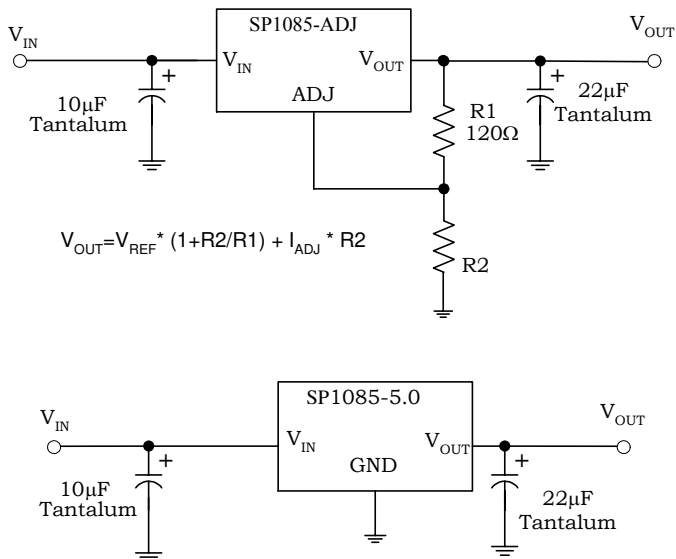
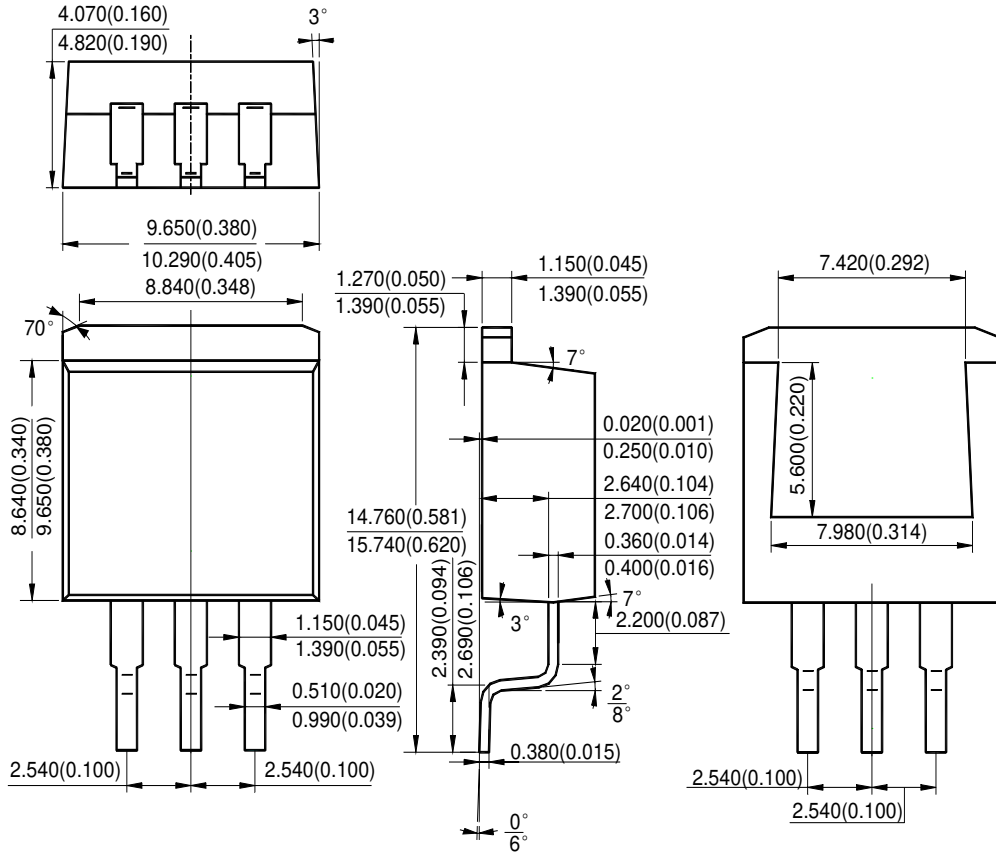

Figure 13. Typical Applications of SP1085

Mechanical Dimensions (Continued)

TO-263-3L

Unit: mm(inch)



Mechanical Dimensions (Continued)

TO-252

Unit: mm(inch)

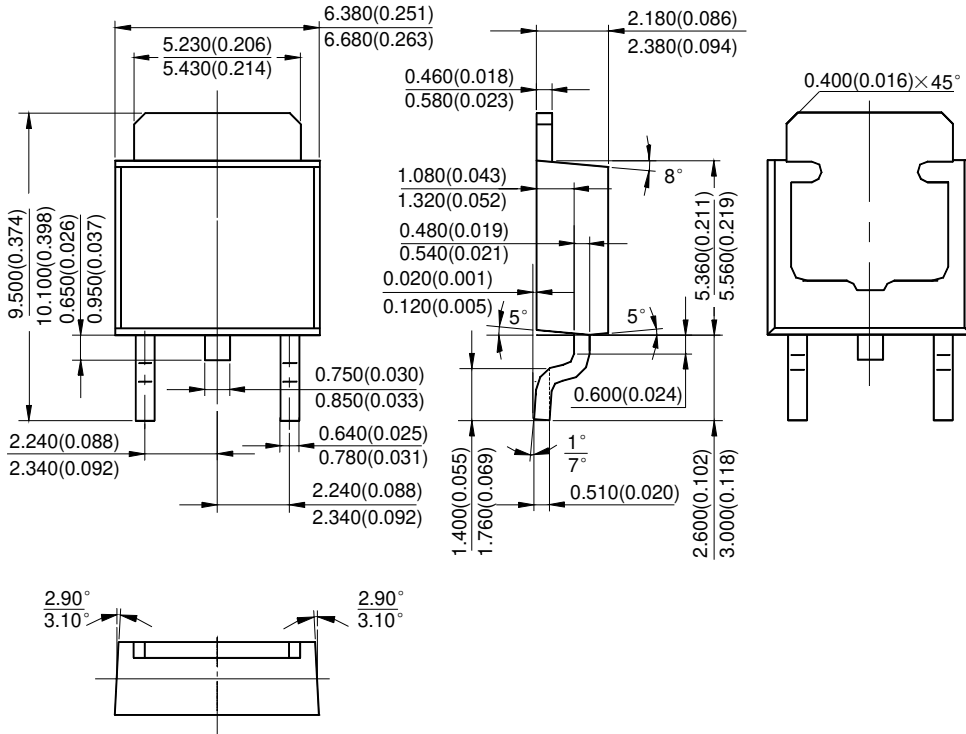

Mechanical Dimensions

TO-220

Unit: mm(inch)

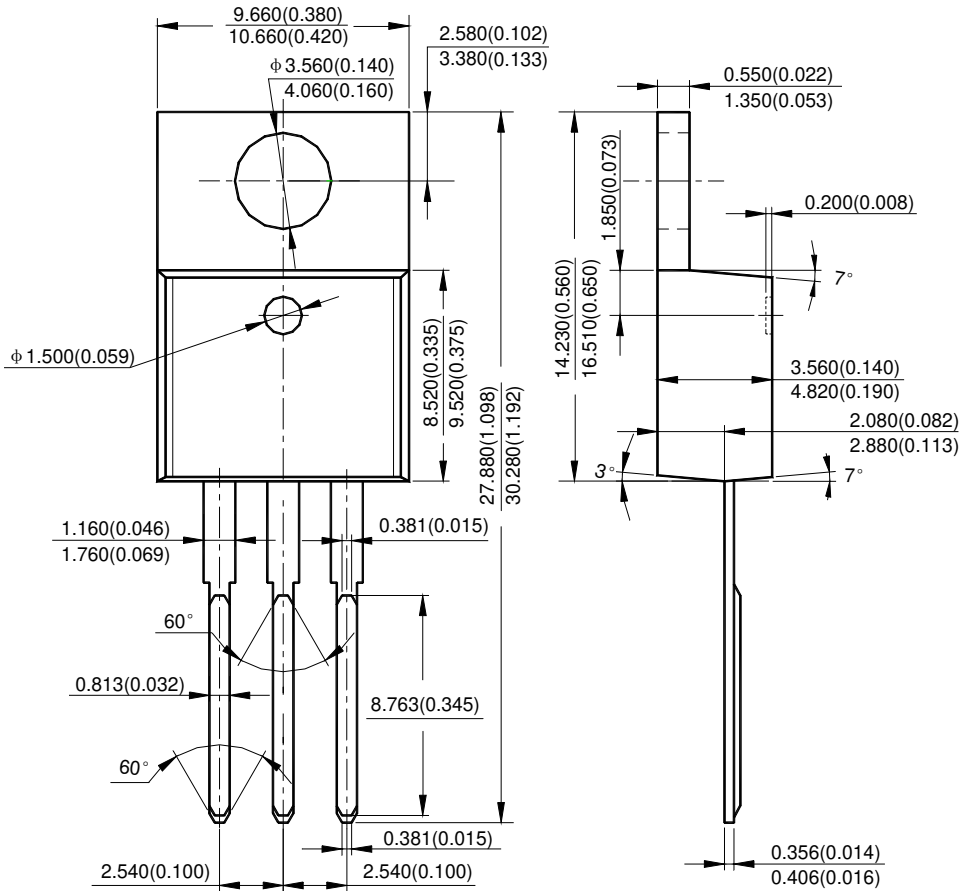

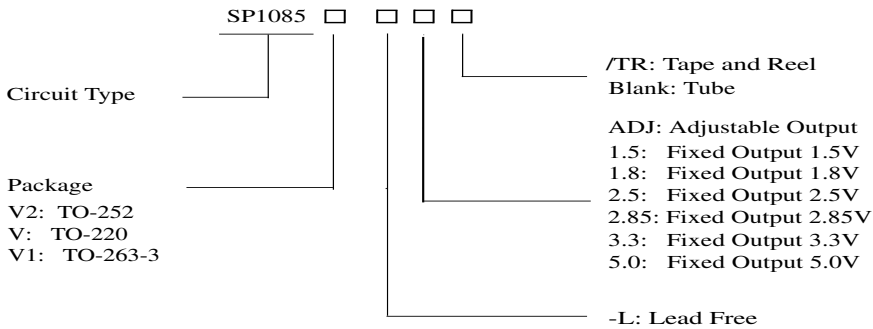

Part Number	Voltage Range	Voltage Accuracy	Temperature Range	Package	Pin Count	Pack Qty
SP1085V2-L/TR	Adj	±2%	0°C to +125°C	TO-252	3	2,500/TR
SP1085V2-L-1-5/TR	1.5V	±2%	0°C to +125°C	TO-252	3	2,500/TR
SP1085V2-L-1-8/TR	1.8V	±2%	0°C to +125°C	TO-252	3	2,500/TR
SP1085V2-L-2-5/TR	2.5V	±2%	0°C to +125°C	TO-252	3	2,500/TR
SP1085V2-L-2-85/TR	2.85V	±2%	0°C to +125°C	TO-252	3	2,500/TR
SP1085V2-L-3-3/TR	3.3V	±2%	0°C to +125°C	TO-252	3	2,500/TR
SP1085V2-L-5-0/TR	5V	±2%	0°C to +125°C	TO-252	3	2,500/TR
SP1085V1-L/TR	Adj	±2%	0°C to +125°C	TO-263	3	800/TR
SP1085V1-L-1-5/TR	1.5V	±2%	0°C to +125°C	TO-263	3	800/TR
SP1085V1-L-1-8/TR	1.8V	±2%	0°C to +125°C	TO-263	3	800/TR
SP1085V1-L-2-5/TR	2.5V	±2%	0°C to +125°C	TO-263	3	800/TR
SP1085V1-L-2-85/TR	2.85V	±2%	0°C to +125°C	TO-263	3	800/TR
SP1085V1-L-3-3/TR	3.3V	±2%	0°C to +125°C	TO-263	3	800/TR
SP1085V1-L-5-0/TR	5V	±2%	0°C to +125°C	TO-263	3	800/TR
SP1085V-L	Adj	±2%	0°C to +125°C	TO-220	3	50/TUBE
SP1085V-L-1-5	1.5V	±2%	0°C to +125°C	TO-220	3	50/TUBE
SP1085V-L-1-8	1.8V	±2%	0°C to +125°C	TO-220	3	50/TUBE
SP1085V-L-2-5	2.5V	±2%	0°C to +125°C	TO-220	3	50/TUBE
SP1085V-L-2-85	2.85V	±2%	0°C to +125°C	TO-220	3	50/TUBE
SP1085V-L-3-3	3.3V	±2%	0°C to +125°C	TO-220	3	50/TUBE
SP1085V-L-5-0	5V	±2%	0°C to +125°C	TO-220	3	50/TUBE



Sipex Corporation

Headquarters and Sales Office

233 South Hillview Drive
Milpitas, CA 95035
TEL: (408) 934-7500
FAX: (408) 935-7600

Sipex Corporation reserves the right to make changes to any products described herein. Sipex does not assume any liability arising out of the application or use of any product or circuit described herein; neither does it convey any license under its patent rights nor the rights of others.