

926868-1 ✓ ACTIVE

MATE-N-LOK | Universal MATE-N-LOK

TE Internal #: 926868-1

Power Contacts, Contact, Tin, 16 – 13 AWG Wire Size, 1.5 – 2.5 mm² Wire Size, Wire & Cable, Crimp, Power, Pin, Brass, Tin, Universal MATE-N-LOK

[View on TE.com >](#)



Connectors > Power Connectors > Power Contacts

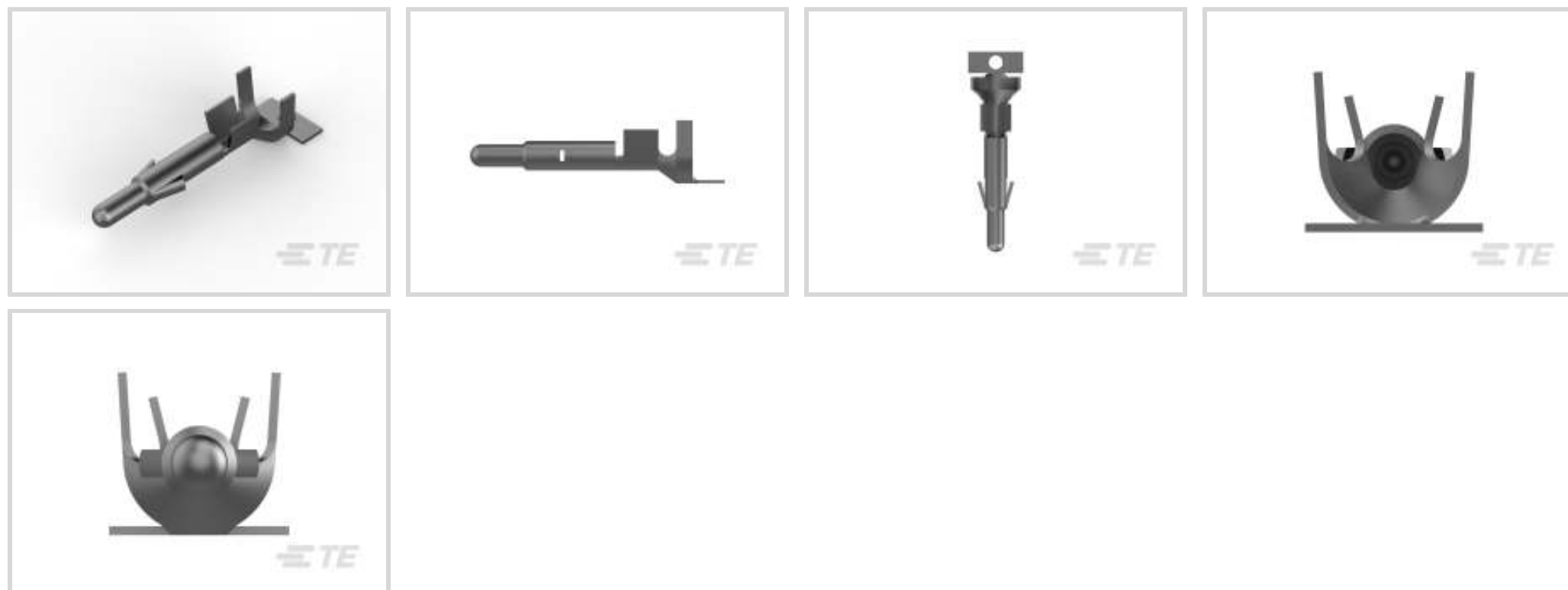

Power Contact Type: **Contact**

Contact Mating Area Plating Material: **Tin**

Wire Size: **1.5 – 2.5 mm²**

Connector & Contact Terminates To: **Wire & Cable**

Features

Product Type Features

Compatible With Discrete Wire Type	Stranded
Power Contact Type	Contact
Connector & Contact Terminates To	Wire & Cable

Contact Features

Contact Mating Area Plating Material	Tin
Contact Type	Pin
Contact Retention Within Housing	With
Mating Pin Diameter	2.06 mm[.081 in]
Contact Base Material	Brass
Wire Contact Termination Area Plating Material	Tin
Wire Contact Termination Area Plating Material Finish	Bright
Contact Orientation	Straight

Termination Features

Termination Method to Wire & Cable	Crimp
------------------------------------	-------



Mechanical Attachment

Contact Retention Type Within Housing	Locking Lance
Wire Insulation Support	Without

Dimensions

Wire Size	1.5 – 2.5 mm ²
Compatible Insulation Diameter Range	3.3 – 5.08 mm [.13 – .2 in]

Operation/Application

Circuit Application	Power
---------------------	-------

Industry Standards

CSA Rating	Certified, LR 16455
UL Rating	Recognized
Agency/Standard	CSA, UL, VDE

Packaging Features

Packaging Quantity	2500
Packaging Method	Reel

Product Compliance

[For compliance documentation, visit the product page on TE.com>](#)

EU RoHS Directive 2011/65/EU	Compliant
EU ELV Directive 2000/53/EC	Compliant
China RoHS 2 Directive MIIT Order No 32, 2016	No Restricted Materials Above Threshold
EU REACH Regulation (EC) No. 1907/2006	Current ECHA Candidate List: JUNE 2023 (235) Candidate List Declared Against: JAN 2023 (233) Does not contain REACH SVHC
Halogen Content	Low Halogen - Br, Cl, F, I < 900 ppm per homogenous material. Also BFR/CFR/PVC Free
Solder Process Capability	Not applicable for solder process capability

Product Compliance Disclaimer

This information is provided based on reasonable inquiry of our suppliers and represents our current actual knowledge based on the information they provided. This information is subject to change. The part numbers that TE has identified as EU RoHS compliant have a maximum concentration of 0.1% by weight in homogenous materials for lead, hexavalent chromium, mercury, PBB, PBDE, DBP, BBP, DEHP, DIBP, and 0.01% for cadmium, or qualify for an exemption to these limits as defined in the Annexes of Directive 2011/65/EU (RoHS2). Finished electrical and electronic equipment products will be CE marked as required by Directive 2011/65/EU. Components may not be CE marked. Additionally, the part

numbers that TE has identified as EU ELV compliant have a maximum concentration of 0.1% by weight in homogenous materials for lead, hexavalent chromium, and mercury, and 0.01% for cadmium, or qualify for an exemption to these limits as defined in the Annexes of Directive 2000/53/EC (ELV). Regarding the REACH Regulation, the information TE provides on SVHC in articles for this part number is based on the latest European Chemicals Agency (ECHA) 'Guidance on requirements for substances in articles' posted at this URL: <https://echa.europa.eu/guidance-documents/guidance-on-reach>

Compatible Parts





Also in the Series | Universal MATE-N-LOK

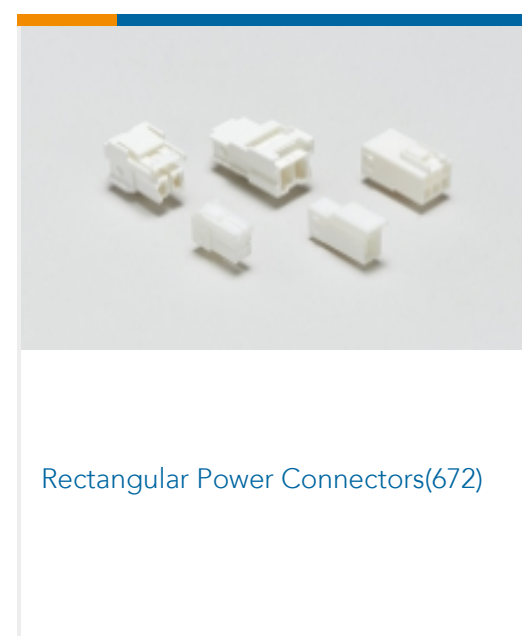
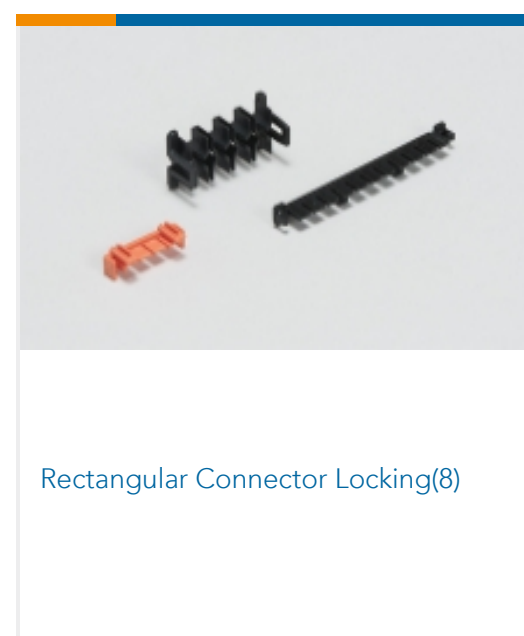
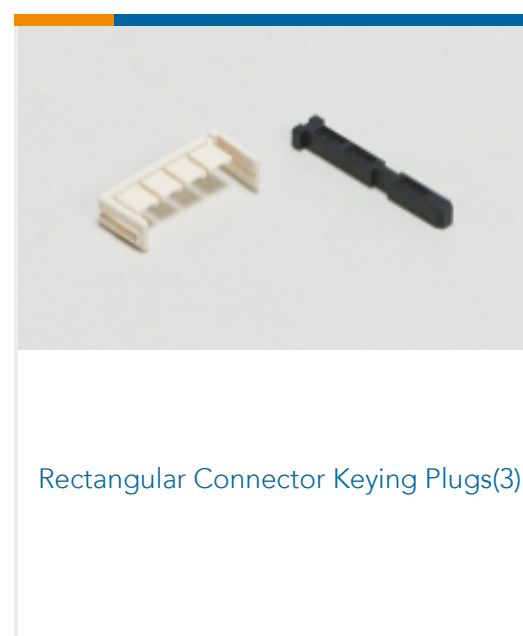
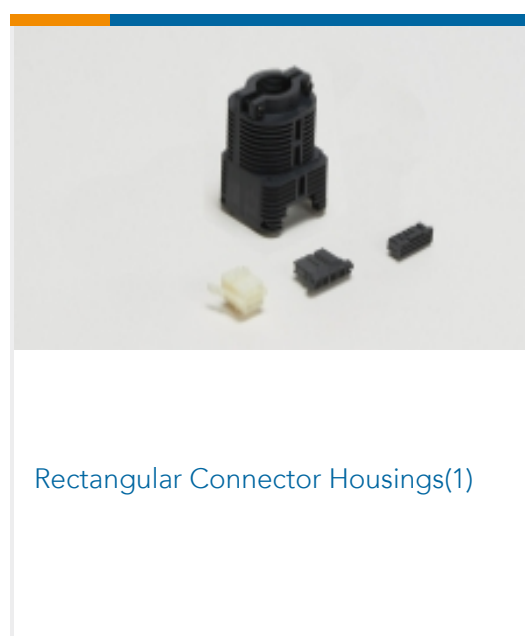
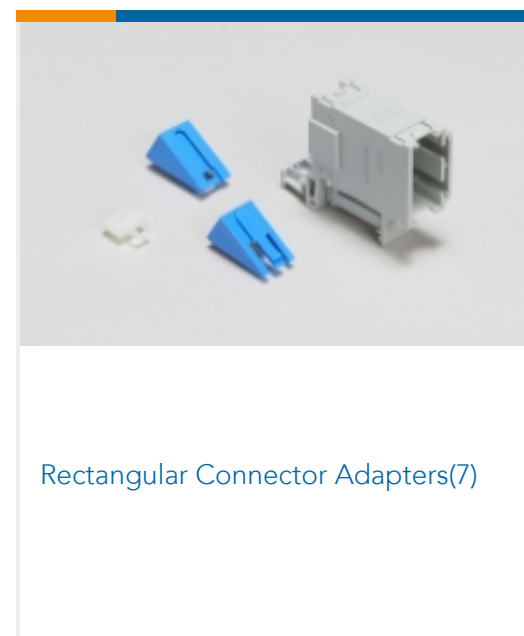
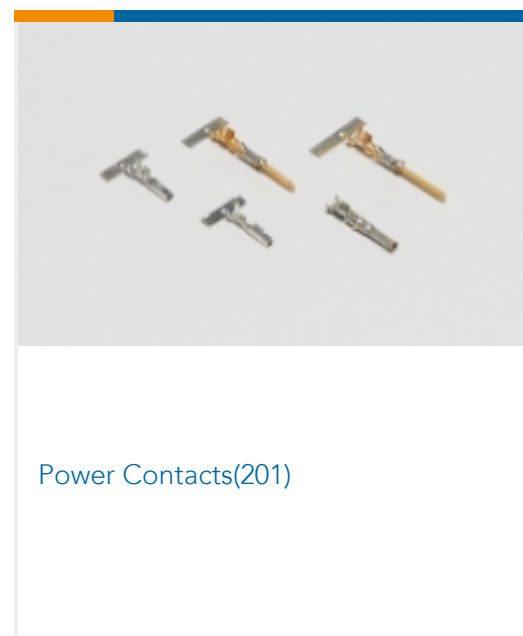
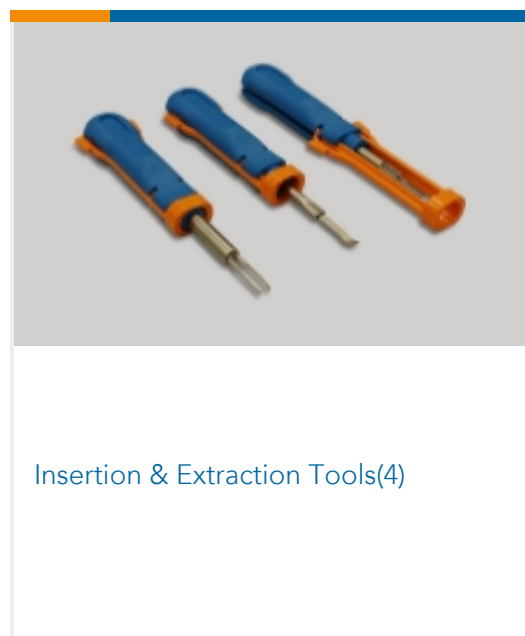
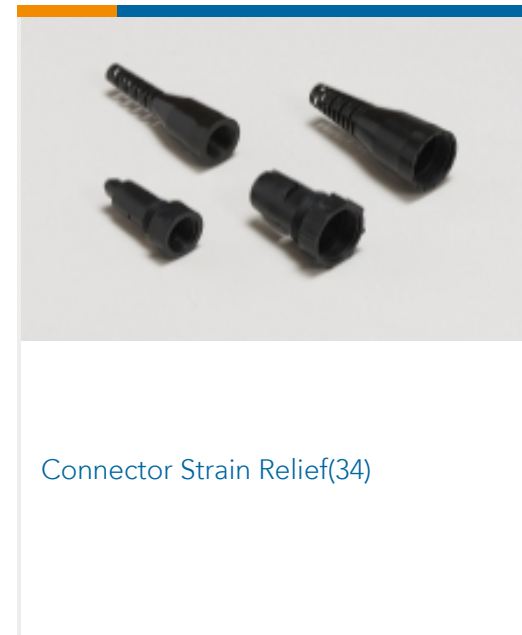
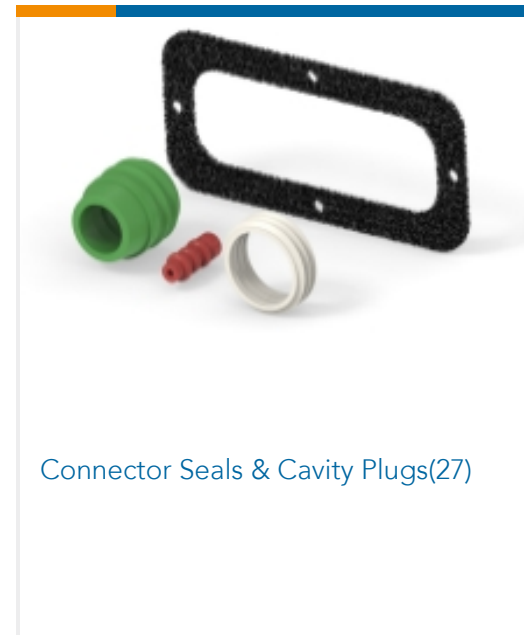
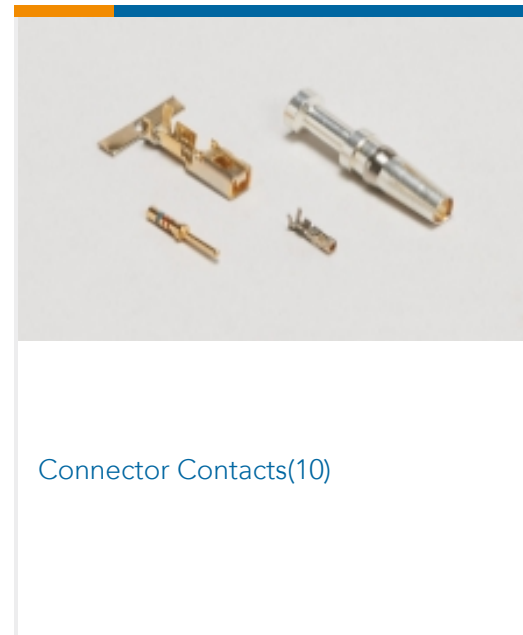
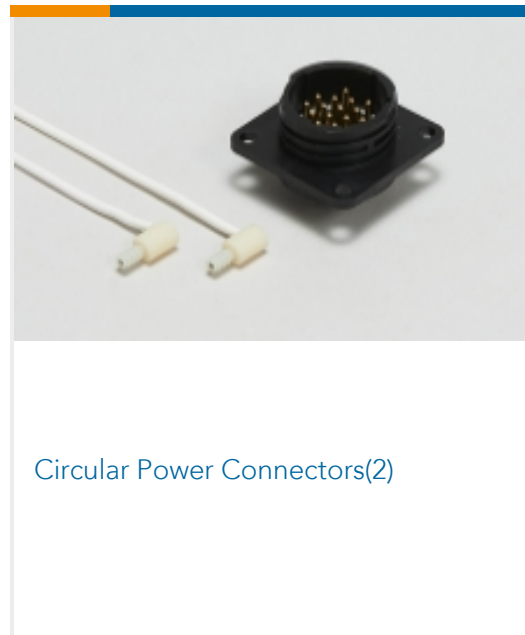

Customers Also Bought

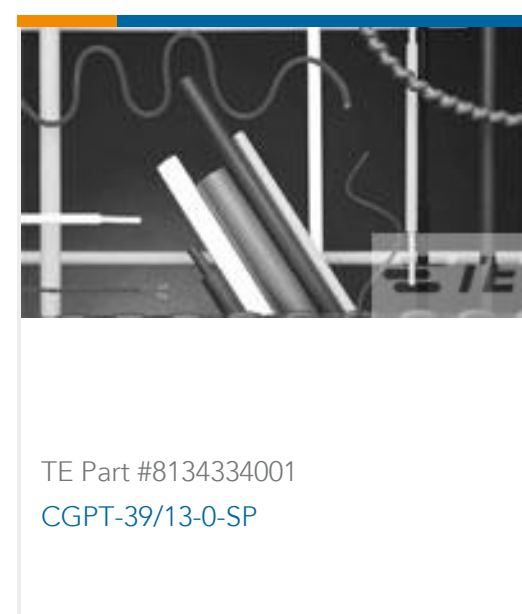

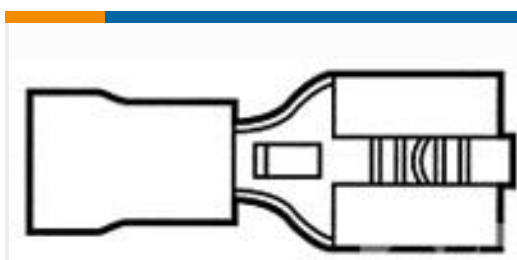

TE Part #5-160583-2
250 PIDG FASTON REC



TE Part #770901-1
MINI UMNL PIN 26-22 AWG SN



TE Part #1-1534415-3
DUOPL POW FEM CON3P

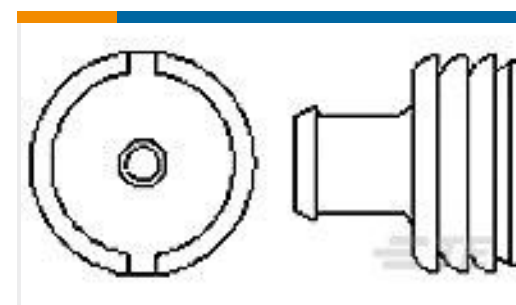

TE Part #967610-1
MPQ EINZELLEITDICHT



TE Part #CD14273001
FLCW0219-0.75-45(B011)

Documents

Product Drawings

[UNIV.M-N-L.PIN](#)

English

CAD Files

Customer View Model

[ENG_CVM_926868-1_G.3d_igs.zip](#)

English

Customer View Model

[ENG_CVM_926868-1_G.3d_stp.zip](#)

English

Customer View Model

[ENG_CVM_926868-1_G.2d_dxf.zip](#)

English

3D PDF

English

3D PDF

3D

Customer View Model

[ENG_CVM_CVM_926868-1_F.2d_dxf.zip](#)

English

Customer View Model

[ENG_CVM_CVM_926868-1_F.3d_igs.zip](#)

English

Customer View Model

[ENG_CVM_CVM_926868-1_F.3d_stp.zip](#)

English



By downloading the CAD file I accept and agree to the [Terms and Conditions](#) of use.

Product Specifications

Application Specification

English

Product Environmental Compliance

Product Compliance

English

Product Compliance

English

Agency Approvals

VDE Certificate

English