

AN-REF-ICL8201_Single End Cap T8

18W 270mA Single Stage Floating Buck LED (Single End Cap T8) Converter with ICL8201 & IPS65R1K5CE

About this document

Scope and purpose

This document is a 18W 270mA average current controlled single stage, cascade structure for floating bulk topology Single End Cap T8 LED lamp reference design using Infineon LED driver ICL8201 (SOT23-6-1) and CoolMOS™ IPS65R1K5CE (IPAK). It has high efficiency, high PFC and various modes of protections with very low external component count. ICL8201 concept supports simple buck inductor without auxiliary winding.

Intended audience

This document is intended for users of ICL8201 who wish to design very low cost, high efficiency and power factor in Single End Cap T8 form factor LED lamp.

Table of Contents

Table of Contents.....	2
1 Introduction.....	3
2 Reference board.....	3
3 Specification	3
4 Schematic	4
5 Single End Cap T8 reference board layout	5
6 Bill of material and transformer specification.....	5
6.1 Bill of material	5
6.2 Transformer specification.....	6
7 Single stage power factor correction	6
8 Protection functions	7
9 Reference board set up, test waveforms and results	8
9.1 Input and output	8
9.2 Start up	8
9.3 Switching waveform.....	9
9.4 Output waveform	10
9.5 Input waveform	11
9.6 Protection waveforms and results (Short output, Open output, Short winding, and Thermal performance & Intelligent over temperature protection)	12
9.6.1 Short output protection.....	12
9.6.2 Open output protection.....	13
9.6.3 Short winding protection.....	14
9.6.4 Intelligent over temperature protection.....	15
9.7 Test results (Power factor, Total Harmonic Distortion (THD), Efficiency, Regulation & Conducted Emissions).....	16
9.7.1 Power Factor and Total Harmonics Distortion	17
9.7.2 Output current regulation	17
9.7.3 Efficiency	18
9.7.4 Conducted emissions (EN55015).....	19
9.7.5 Lightning Surge (EN61000-4-5).....	20
10 References	21
Revision History	21

Introduction

1 Introduction

This application note is an engineering report of Single End Cap T8 LED lamp reference design for High Line input 18W 66V converter. The converter is using ICL8201 (SOT23-6-1), average current controlled, non-isolated single stage buck topology in cascade structure LED driver and IPS65R1K5CE (IPAK), a CE series of high voltage power CoolMOS™. The distinguishing features of this reference design are high efficiency and power factor with single stage design, critical conduction operation mode with single choke (without auxiliary winding), truly regulated output current over a wide output voltage range, good EMI performance and various modes of protections for high reliability with small form factor which can be easily fit into single end cap of standard T8 LED lamp.

2 Reference board

This document contains the list of features, the power supply specification, schematic, bill of material and the transformer construction documentation. Typical operating characteristics such as performance curve and scope waveforms are shown at the rear of the report.

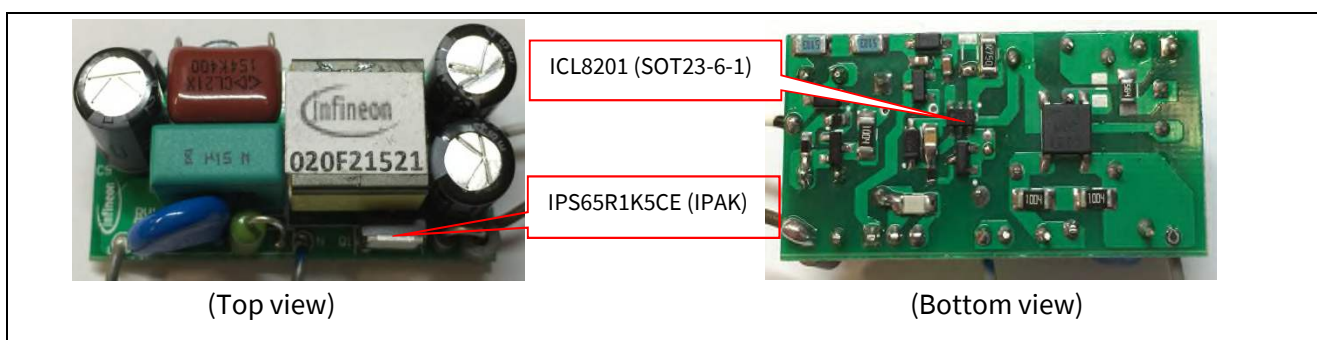

Figure 1 REF-ICL8201_T8 [Size(L x W x H): 42mm x 20mm x 15mm]

3 Specification

Table 1 Specification of REF-ICL8201_T8

Input voltage & frequency	170V _{AC} ~277 V _{AC} (50Hz)
Output voltage, current & power	55V~75V, 270mA, 18W
Power factor	>0.95
THD	< 20%
Efficiency	>90%
Conducted emissions (EN55015)	>10dB margin

Schematic

4 Schematic

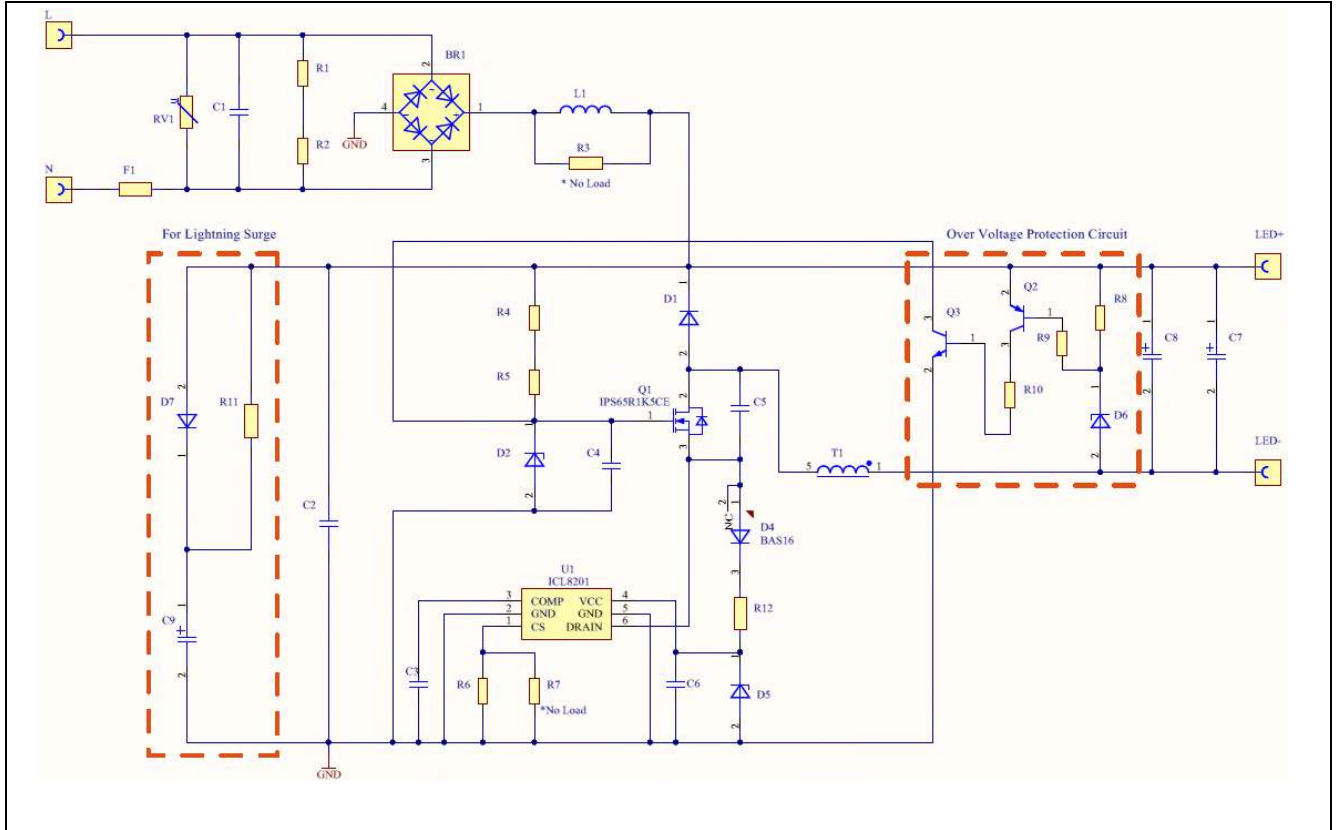

Figure 2 Schematic of REF-ICL8201_T8

5 Single End Cap T8 reference board layout

The reference board has double layers PCB with dimension of 42x20mm and thickness of 1mm is used. The maximum height of the demo board is 15mm. With its compact form factor, this reference board is able to fit into Single End Cap T8 lamp.

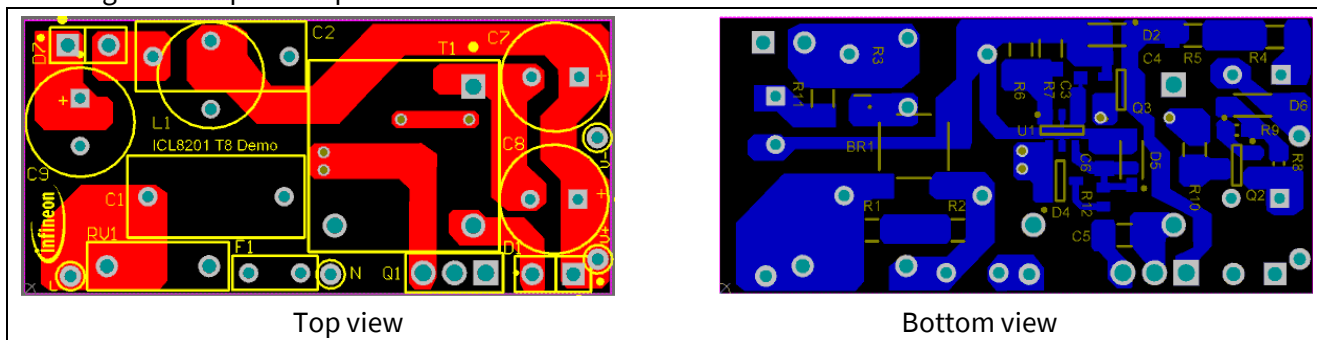

Figure 3 Top and bottom view

6 Bill of material and transformer specification

6.1 Bill of material

Table 2 Bill of material

No.	Designator	Manufacturer	Part Number	Description	Qty
1	F1	Littlefuse	0263003.MXL	FUSE, PCB, 3A, 250V, VERY FAST ACTING	1
2	RV1	EPCOS	B72210S0301K101	VARISTOR 423V 2.5KA DISC 10MM	1
3	BR1	Micro Commercial	LMB6S-TP	BRIDGE RECTIFIER 0.8A 600V LMBS-1	1
4	L1	Bourns	RL875-222K-RC	INDUCTOR, 2.2mH, ±10%, 180mA, DCR=6.25Ω	1
5	D1	ON Semi	MUR260G	DIODE, RECTIFIER, 2A, 600V, DO-15	1
6	D2,D5	ON Semi	MMSZ5245BT1G	DIODE ZENER 15V 500MW SOD123	2
7	D4	Infineon	BAS 16 E6327	DIODE SWITCH 80V 0.25A SOT23	1
8	D6	ON Semi	MMSZ5268BT1G	DIODE, ZENER, 82V, 500mW, SOD-123	1
9	D7	MULTICOMP	1N4007G	DIODE, STANDARD, 1A, 1000V, DO41	1
10	C1	Kemet	F861AP154M310L	CAP FILM 0.15UF 630VDC RADIAL (P=10mm)	1
11	C2	Faratronic	C222G154K40	CAP FILM 0.15UF 400VDC 10% RADIAL	1
12	C3	Murata	GRM188R71A225KE15D	CAP CER 2.2uF 10V 10% X7R 0603	1
13	C4	Yageo	CC0603KRX7R8BB103	CAP CER 10nF 25V 10% X7R 0603	1
14	C5	Yageo	CC1206JRNPOBBN220	CAP CER 22pF 500V 5% NPO 1206	1
15	C6	Murata	GRM21BR71E225KA73L	CAP CER 2.2uF 25V 10% X7R 0805	1
16	C7, C8	RUBYCON	100ZLJ33M8X11.5	CAP ALU 100V, 33uF, ±20%, 10,000hrs @ 105	2
17	C9	Rubycon	400PX2R2MEFC8X11.5	CAP, ALU ELEC, 2.2UF, 400V, RAD	1
18	R1, R2, R10	Yageo	RC1206FR-071ML	RES 1.00M OHM 1/4W 1% 1206 SMD	3
19	R4, R5	KOA Spear	RK73H2BTDD5103F	RES 510K OHM 1/4W 1% 1206 SMD	2
20	R6	Vishay	RCWE1206R750FKEA	RES 0.75R OHM 1/2W 1% 1206 SMD	1
21	R8	Yageo	RC0603FR-071KL	RES 1K OHM 1/10W 1% 0603 SMD	1
22	R9	Yageo	RC0603FR-0710KL	RES 10K OHM 1/10W 1% 0603 SMD	1
23	R11	Yageo	RC0805JR-07560KL	RES 560K OHM 1/8W 5% 0805 SMD	1
24	R12	Yageo	RC0603JR-074R7L	RES 4.7 OHM 1/10W 5% 0603 SMD	1
25	T1	Würth	750342737	EP13, 850uH, ±10%	1
26	Q1	Infineon	IPS65R1K5CE	MOSFET, 650V, 3.1A, 1.5Ω, IPAK	1
27	Q2	NXP	PBHV9050T	TRANS PNP 500V 150MA SOT23	1
28	Q3	Infineon	SMBT3904	TRANS NPN 40V 150MA SOT23	1
29	U1	Infineon	ICL8201	LED Buck Controller, SOT23-6-1	1
30	Ferrite Bead Core	KEMET	B-20F-38	FERRITE CORE, CYLINDRICAL, 1.5MM X 4.3MM	1
31	PCB			FR4, 2 Layer, 1oz, Soldermask, 42x20x15 mm	1

18W 270mA Single Stage Floating Buck LED (Single End Cap T8) Converter with ICL8201 & IPS65R1K5CE



Transformer Specification and PFC

6.2 Transformer specification

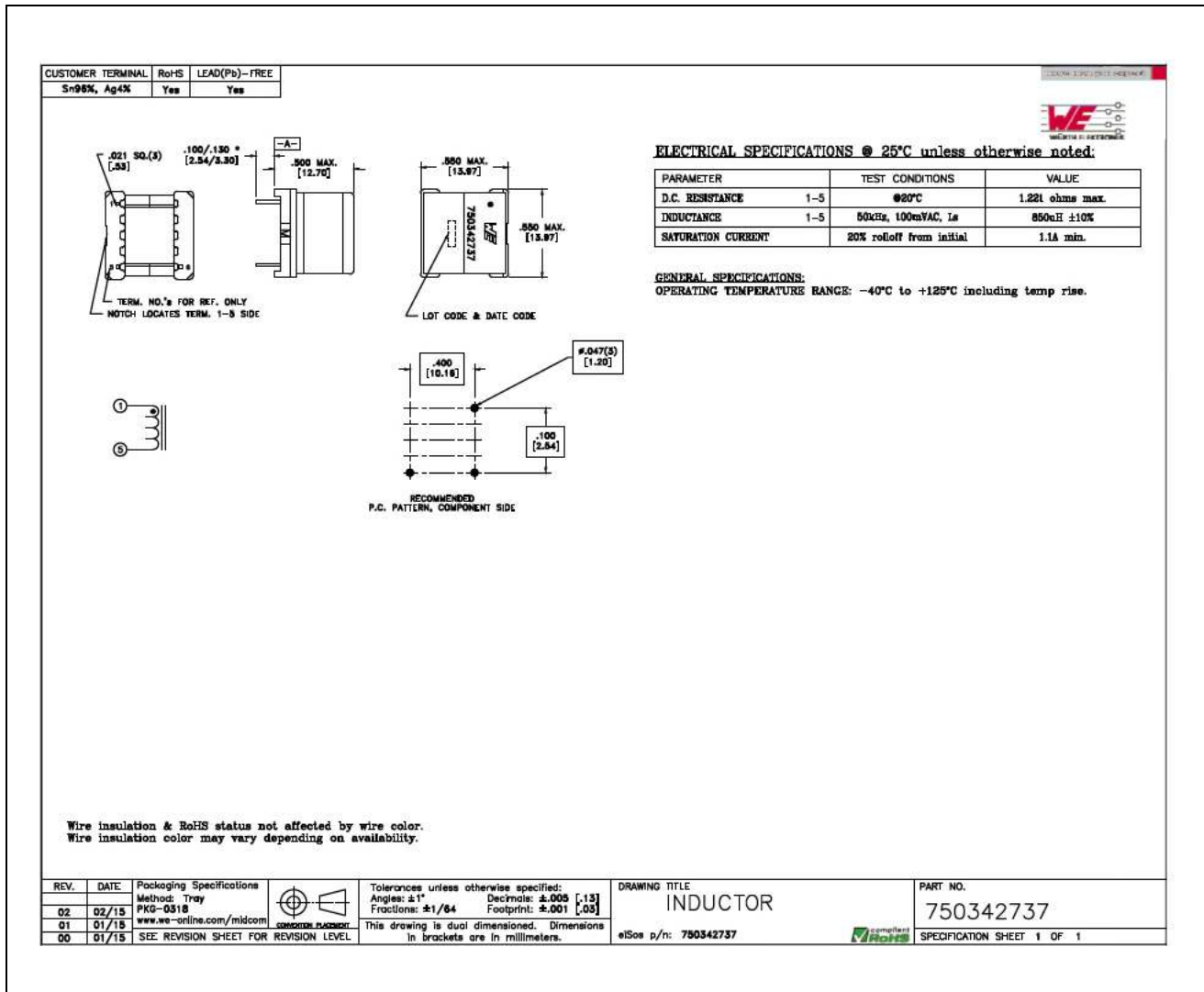

Figure 4 Transformer structure

7 Single stage power factor correction

Single stage power factor correction (PFC) zero current detection bulk helps realising highly efficient, cost effective and compact LED driver design. In this reference board, ICL8201 achieves the single stage power factor correction by fixing on time over half AC sinusoidal cycle waveform.

As can be noted from below picture, the averaged input current is shaped to be approximately sinusoidal and thus high power factor is achieved with input current harmonics fulfilling the requirements of EN 61000-3-2 standard.

Protection functions

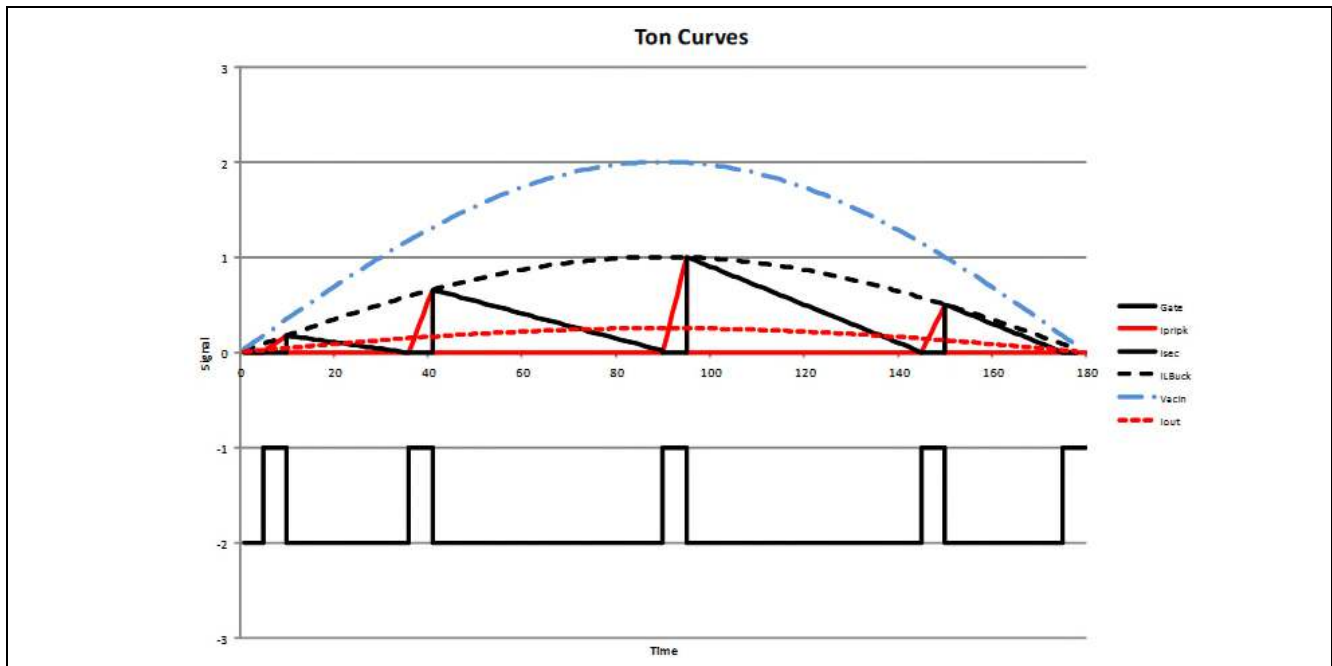

Figure 5 Voltage and current waveforms in half AC cycle

8 Protection functions

The protection functions of ICL8201 are listed below.

Table 3 ICL8201 protection functions

VCS Short (Pin 1) to GND	Latch
VCS Open (Pin 1)	Latch
VCon Short (PIN 3) to GND	Latch
VCon OPEN (PIN 3)	Latch
Short OUTPUT	Latch
Short Winding (Main Choke)	Latch
Intelligent Over Temperature Protection (iOTP)	Latch

Note: Over voltage protection circuit (shown in Figure 2) is externally added in this reference board and it is auto restart mode.

9 Reference board set up, test waveforms and results

9.1 Input and output

The input of REF-ICL8201_T8 is Live (L) and Neutral (N) wires and its operating input AC voltage range is $170V_{AC} \sim 277V_{AC}$.

The output of REF-ICL8201_T8 is V+ and V- wires which can supply 66V, 270mA to the LED module.

Attention: As this is a non-isolated design, high voltage exists at the output! An isolated transformer is advised to be used during evaluating of this reference board.

9.2 Start up

When the AC input voltage is applied to the reference board, V_{CC} capacitor will be charged through external LED module, Buck choke (T1), external power switch (Q1) and V_{CC} diode (D4). Once the V_{CC} voltage reaches 7.5V, the IC will start switching with a digital soft start and enter into normal operation.

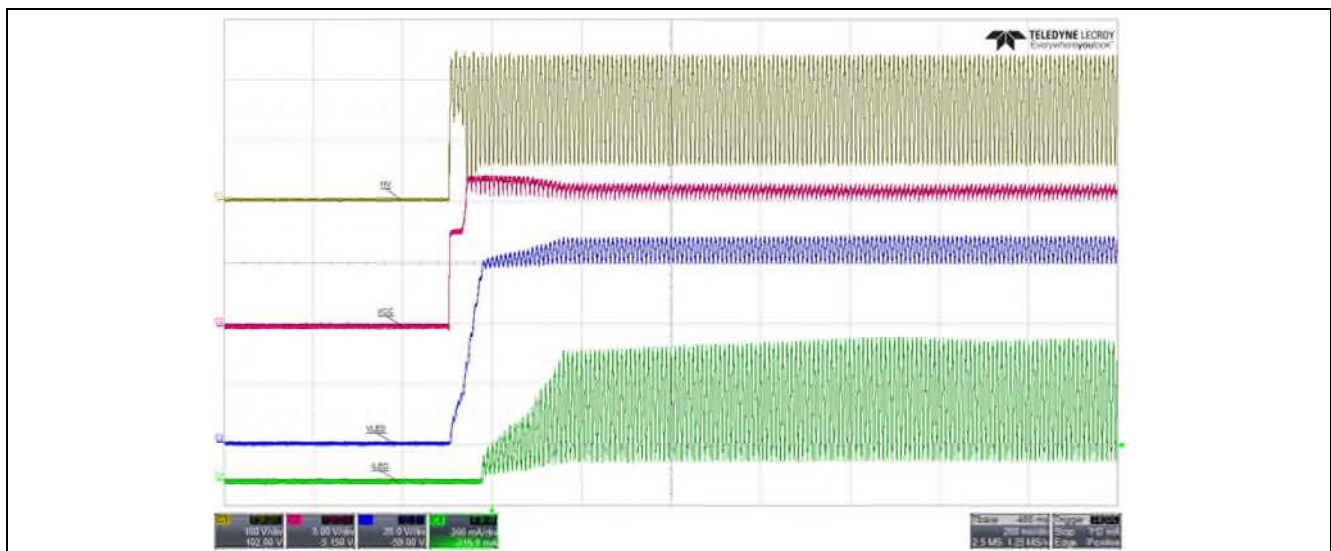

- C1(Yellow) : Bulk voltage (V_{Bulk})
- C2(Red) : Supply voltage (V_{CC})
- C3(Blue) : LED module voltage (V_{LED})
- C4(Green) : LED module current (I_{LED})

Figure 6 Startup waveform

9.3 Switching waveform

The current mode controller, ICL8201 uses zero current switching technique without zero crossing detection winding but by sensing the drain pin voltage of the controller. This helps to simplify the structure of the buck choke without auxiliary winding and improve both EMI and efficiency performance. Typical switching waveform of ICL8201 is as shown below.

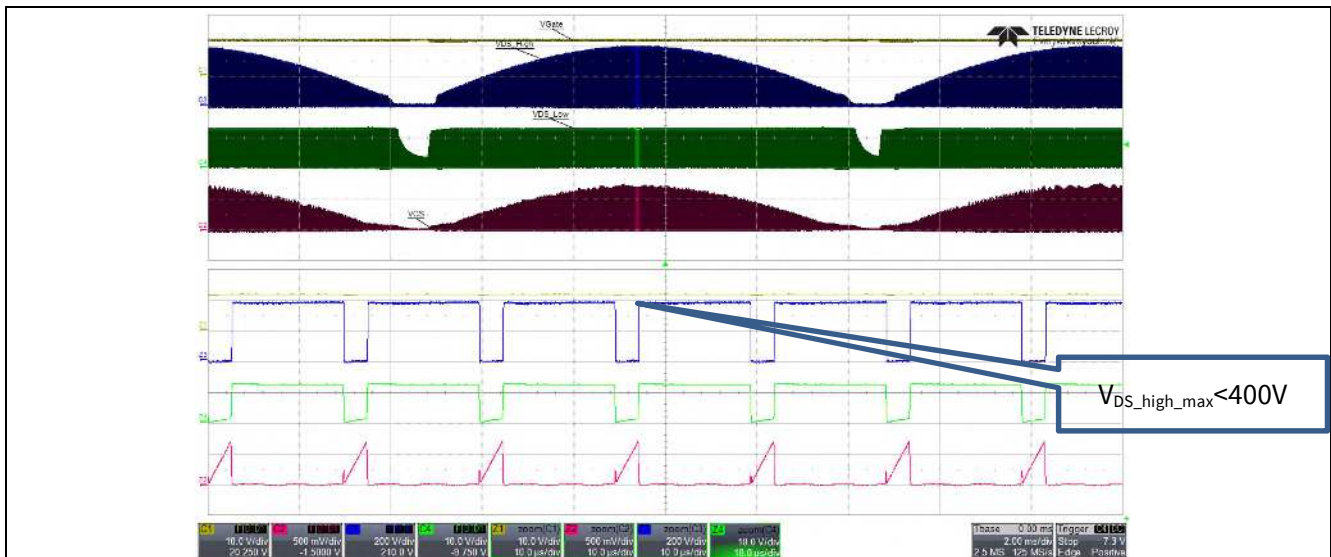

- C1 (Yellow) : Gate voltage of high-side MOSFET (V_{Gate_High})
- C2 (Red) : Current sense voltage (V_{CS})
- C3 (Blue) : Drain to source voltage of high-side MOSFET (V_{DS_High})
- C4 (Green) : Drain voltage of low-side MOSFET (V_{D_Low})

Figure 7 Switching waveform @ 277 V_{AC}

9.4 Output waveform

The output capacitor is sized for an output current ripple which exhibits no visible light modulation. The following figure shows the measured waveform of output voltage and current during normal operation at 230V_{AC} and full load.

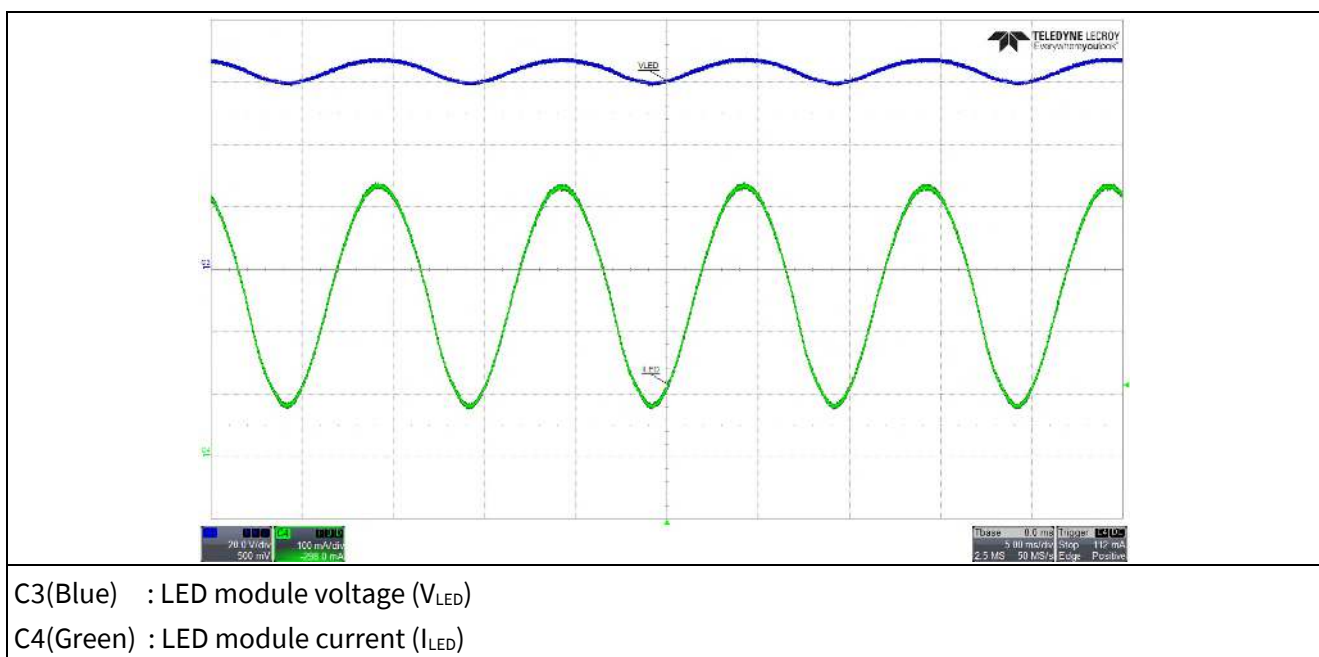
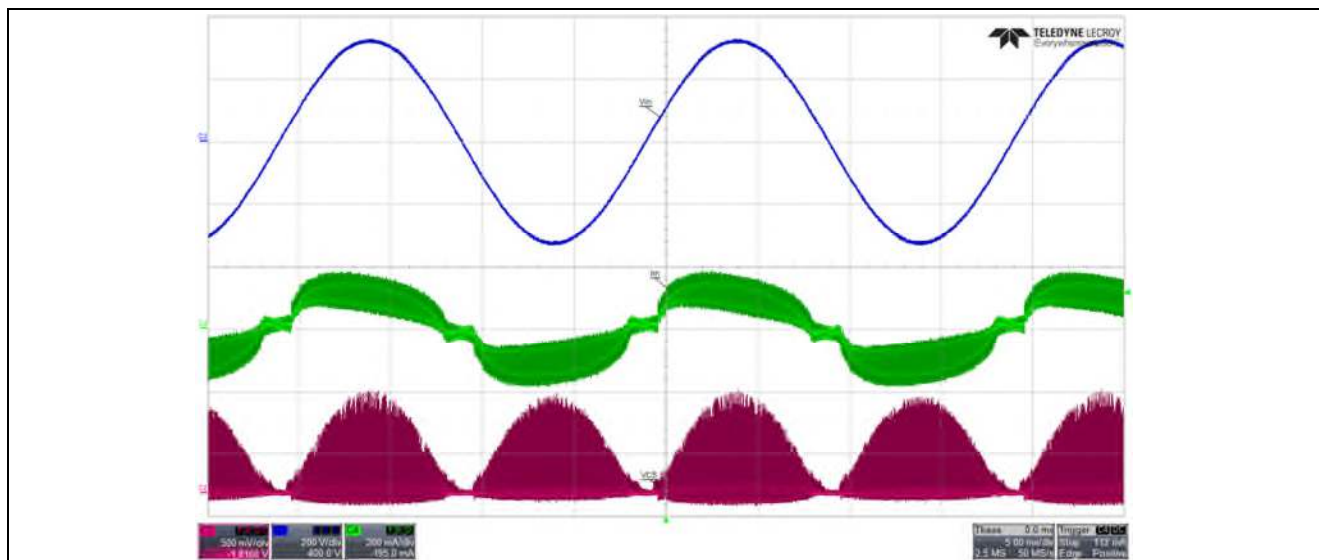

Figure 8 Output voltage and current @ 230V_{AC}

9.5 Input waveform

Below figure shows the waveform of input voltage, current and the current sense pin voltage during normal operation at 230V_{AC} and full load.



C2(Red) : Current sense voltage (V_{CS})

C3(Blue) : Input AC voltage (V_{in})

C4(Green) : Input AC current (I_{in})

Figure 9 Input voltage and current @ 230V_{AC}

9.6 Protection waveforms and results (Short output, Open output, Short winding, and Thermal performance & Intelligent over temperature protection)

9.6.1 Short output protection

The tested waveform at StartUp mode and Run Mode is shown as below, the system board enters to latch mode, and the power consumption is 0.26W @ $V_{in}=230V_{ac}/50Hz$.

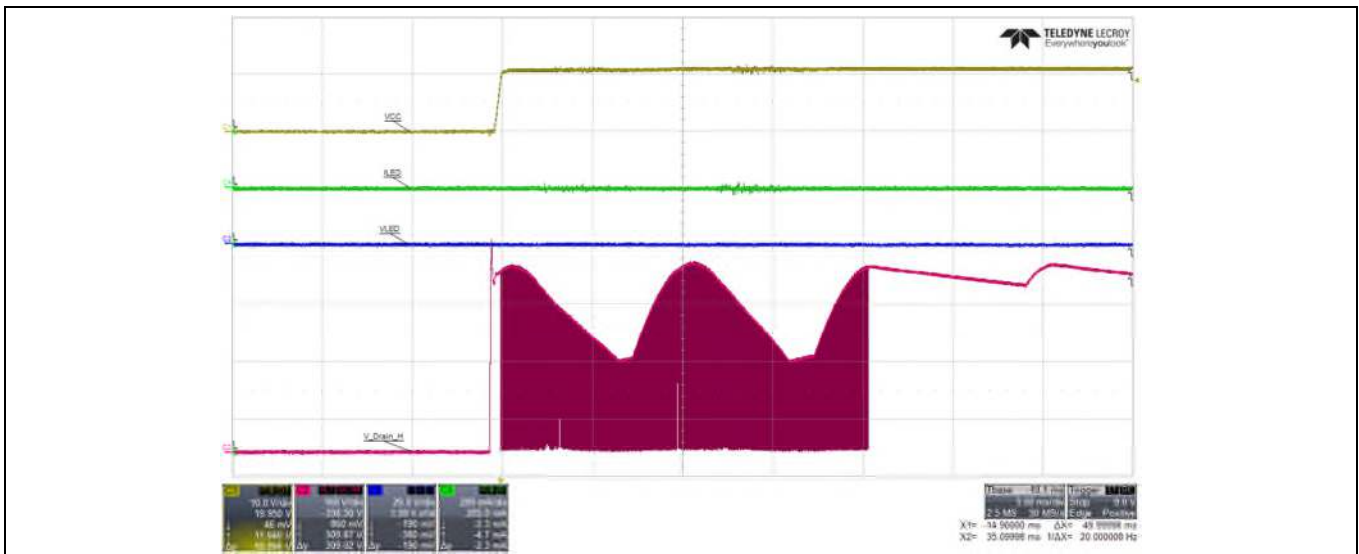

C1 (Yellow) : Vcc voltage (V_{CC})	C3 (Blue) : LED module voltage (V_{LED})
C2 (Red) : High side MOSFET Drain voltage (V_{Drain_H})	C4 (Green) : LED module current (I_{LED})

Figure 10 Waveform of StartUp Mode (66V, 270mA LED load@ $V_{in}=230V_{AC}/50Hz$)

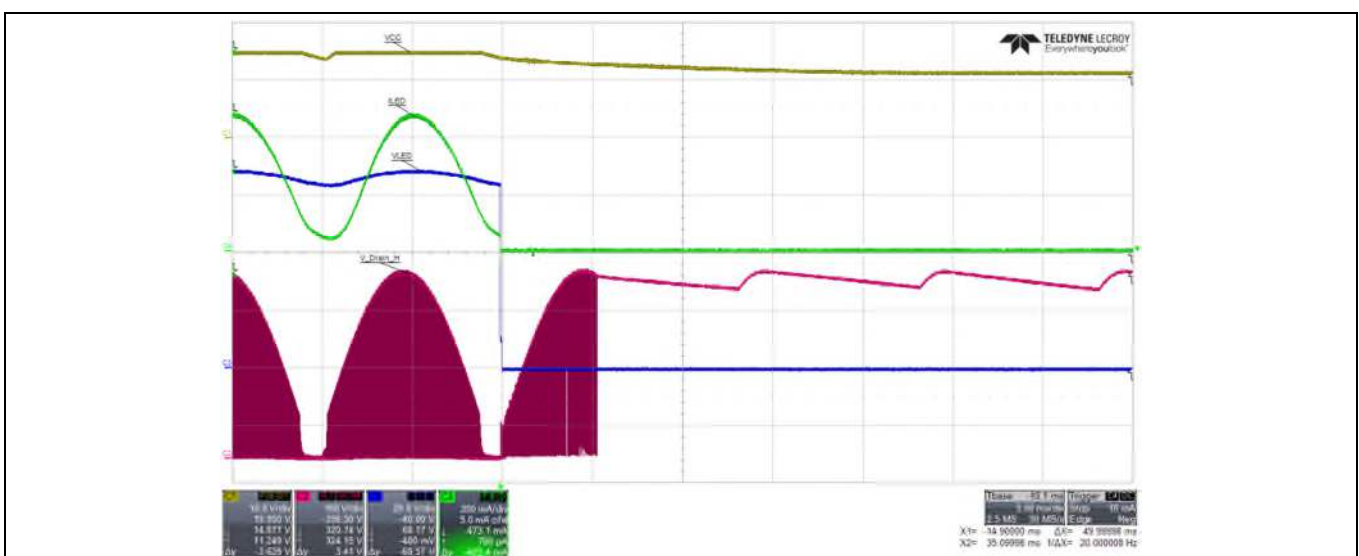

C1 (Yellow) : Vcc voltage (V_{CC})	C3 (Blue) : LED module voltage (V_{LED})
C2 (Red) : High side MOSFET Drain voltage (V_{Drain_H})	C4 (Green) : LED module current (I_{LED})

Figure 11 Waveform of Run Mode (66V, 270mA LED load@ $V_{in}=230V_{AC}/50Hz$)

9.6.2 Open output protection

With adding external OVP circuit, this reference design can achieve output open protection. The tested waveform at StartUp mode and Run Mode is shown as below, the system board enters to auto restart mode, the power consumption is 0.3W and the V_{LED} is clamped to 78V@ $V_{in}=230V_{AC}/50Hz$.

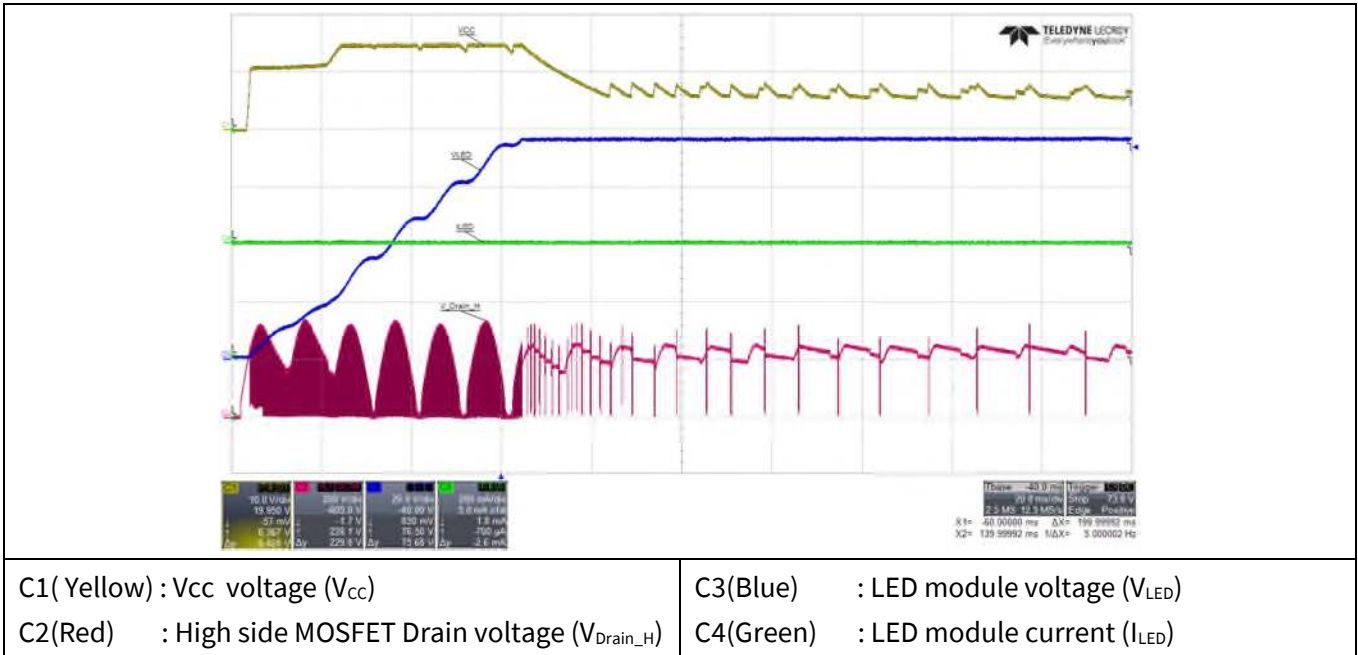

Figure 12 Waveform of StartUp Mode (66V, 270mA LED load@ $V_{in}=230V_{AC}/50Hz$)

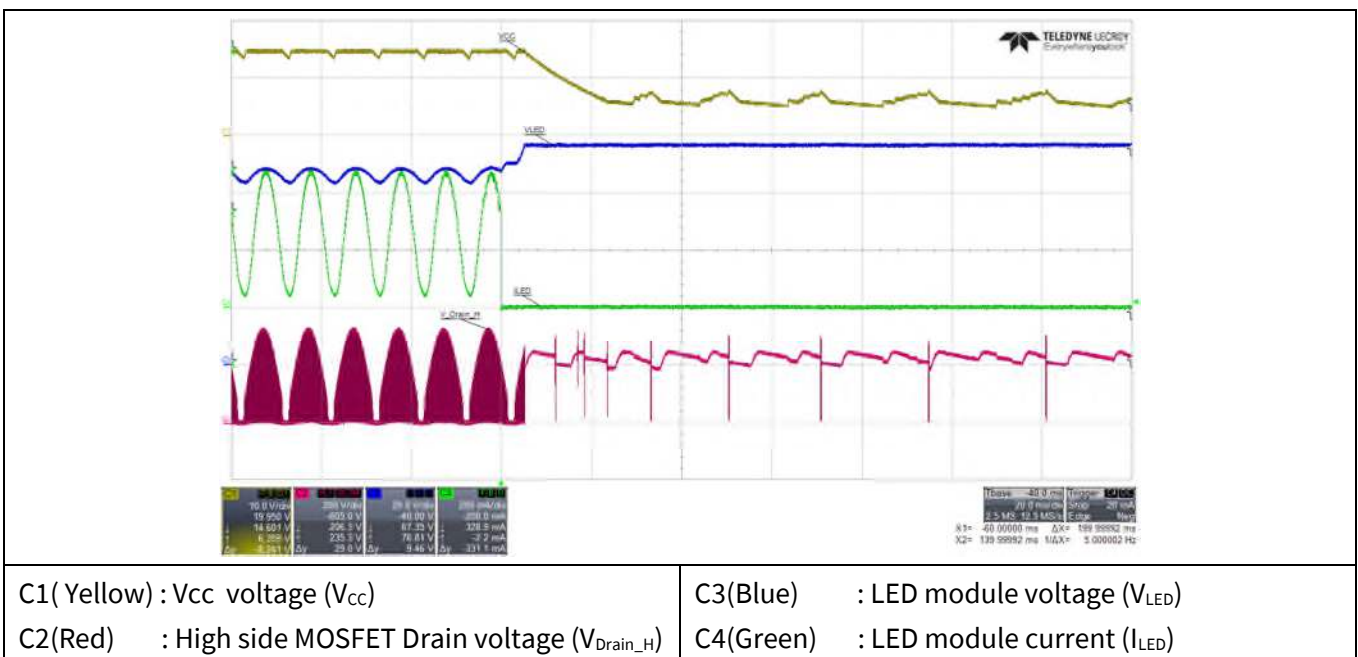
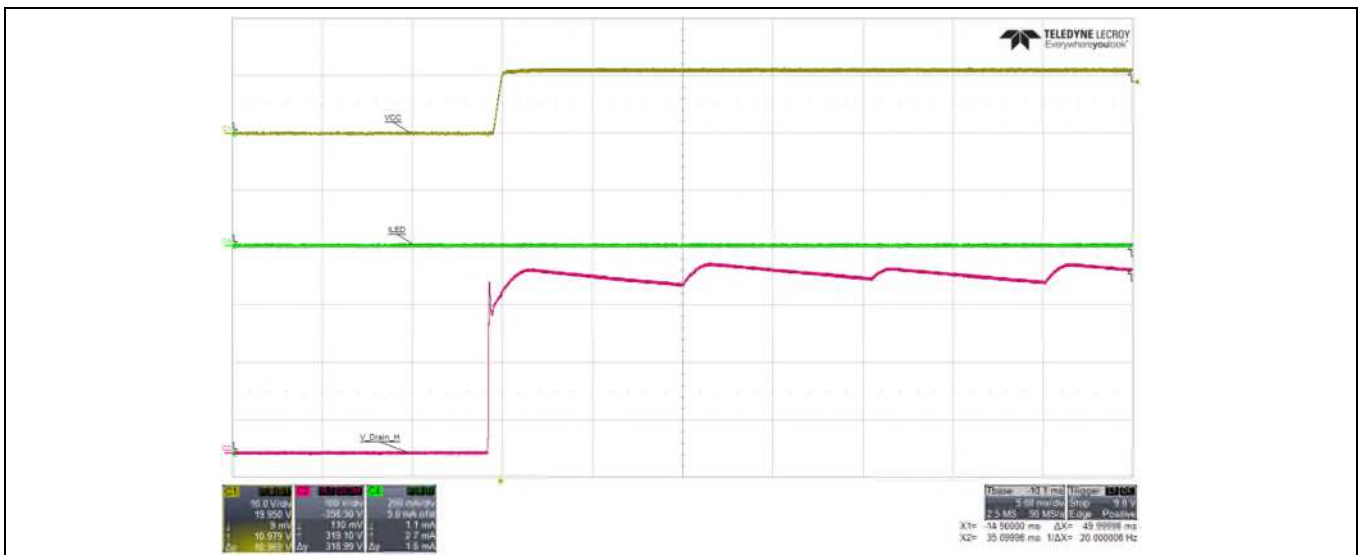

Figure 13 Waveform of Run Mode (66V, 270mA LED load@ $V_{in}=230V_{AC}/50Hz$)

9.6.3 Short winding protection

Below figures show the waveforms of V_{CC} , LED output current and the Drain of high side MOSFET voltage during the short winding protection under StartUp and Run Mode. The system board enters to latch mode and the power consumption is 0.23W @ $V_{in} = 230V/50Hz$.



- C1(Yellow) : V_{CC} voltage (V_{CC})
- C2(Red) : High side MOSFET Drain voltage (V_{Drain_H})
- C4(Green) : LED module current (I_{LED})

Figure 14 Waveform of StartUp Mode (66V, 270mA LED load@ $V_{in}=230V_{AC}/50Hz$)

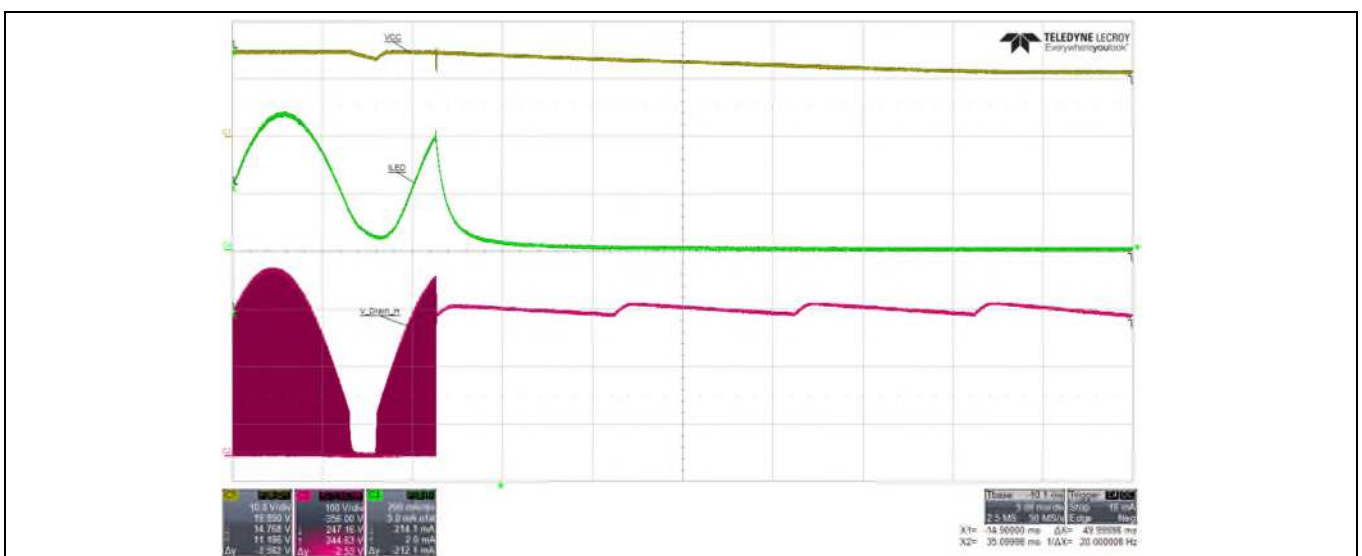

- C1(Yellow) : V_{CC} voltage (V_{CC})
- C2(Red) : High side MOSFET Drain voltage (V_{Drain_H})
- C4(Green) : LED module current (I_{LED})

Figure 15 Waveform of Run Mode (66V, 270mA LED load@ $V_{in}=230V_{AC}/50Hz$)

9.6.4 Thermal performance and Intelligent over temperature protection

Below Image show the thermal of IC and power MOSFET after running for >30 minutes under conditions of open frame board and 25°C Ambient temperature.



Figure 16 Bottom Side. U1=57.2°C; Q1=66.7°C (66V, 270mA LED load@Vin=230V_{AC}/50Hz)

ICL8201 has Intelligent over temperature protection shown as below (Figure 17). It reduces the output current in 7 digital steps down to 50% of target value of I_{LED} in the event of overheating IC (T_j>150°C). If the temperature continues to increase and exceeds T_j > 160 °C, the IC will enter LATCH OFF mode.

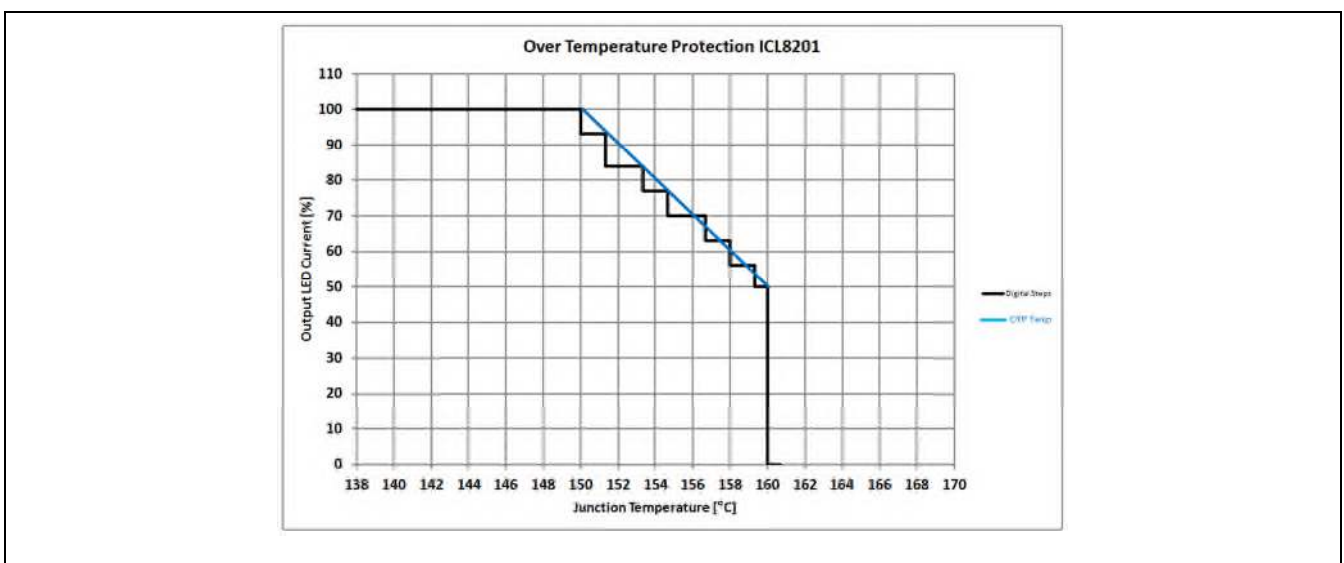

Figure 17 Standard curve of Intelligent Over-Temperature Protection (iOTP)

18W 270mA Single Stage Floating Buck LED (Single End Cap T8) Converter with ICL8201 & IPS65R1K5CE



Reference board set up, test waveforms and results

9.7 Test results (Power factor, Total Harmonic Distortion (THD), Efficiency, Regulation & Conducted Emissions)

Table 4 Power Factor, THD, Efficiency & Regulation

66V, 270mA LED load

V _{in} @ 50Hz (V _{AC})	P _{in} (W)	PF	THD	V _{out} (V _{DC})	I _{out} (mA)	P _{out} (W)	ΔI _{out} (%)	Efficiency (%)	Average Efficiency (%)
170	19.30	0.98	13.47	66.34	268	17.78	-0.74	92.12	91.69
200	19.28	0.98	12.48	66.35	267	17.72	-1.11	91.89	
230	19.34	0.97	12.88	66.38	267	17.72	-1.11	91.64	
265	19.46	0.96	14.13	66.40	268	17.80	-0.74	91.45	
277	19.48	0.95	14.62	66.40	268	17.80	-0.74	91.35	

75V, 270mA LED load

V _{in} @ 50Hz (V _{AC})	P _{in} (W)	PF	THD	V _{out} (V _{DC})	I _{out} (mA)	P _{out} (W)	ΔI _{out} (%)	Efficiency (%)	Average Efficiency (%)
170	21.65	0.98	15.48	74.60	268	19.99	-0.74	92.35	91.99
200	21.61	0.98	13.20	74.65	267	19.93	-1.11	92.23	
230	21.64	0.98	12.68	74.65	267	19.93	-1.11	92.11	
265	21.75	0.96	13.29	74.67	267	19.94	-1.11	91.66	
277	21.77	0.96	13.64	74.67	267	19.94	-1.11	91.58	

55V, 270mA LED load

V _{in} @ 50Hz (V _{AC})	P _{in} (W)	PF	THD	V _{out} (V _{DC})	I _{out} (mA)	P _{out} (W)	ΔI _{out} (%)	Efficiency (%)	Average Efficiency (%)
170	16.16	0.98	12.12	55.30	267	14.77	-1.11	91.37	90.71
200	16.17	0.98	12.76	55.30	267	14.77	-1.11	91.31	
230	16.22	0.96	14.08	55.30	266	14.71	-1.48	90.69	
265	16.33	0.94	15.80	55.36	266	14.73	-1.48	90.18	
277	16.36	0.93	16.34	55.36	266	14.73	-1.48	90.01	

Reference board set up, test waveforms and results

9.7.1 Power Factor and Total Harmonics Distortion

The measured power factor and total harmonics distortion (THD) at different input voltages is as shown below. The power factor is above 0.95 and THD is less than 15% over the whole input voltage range.

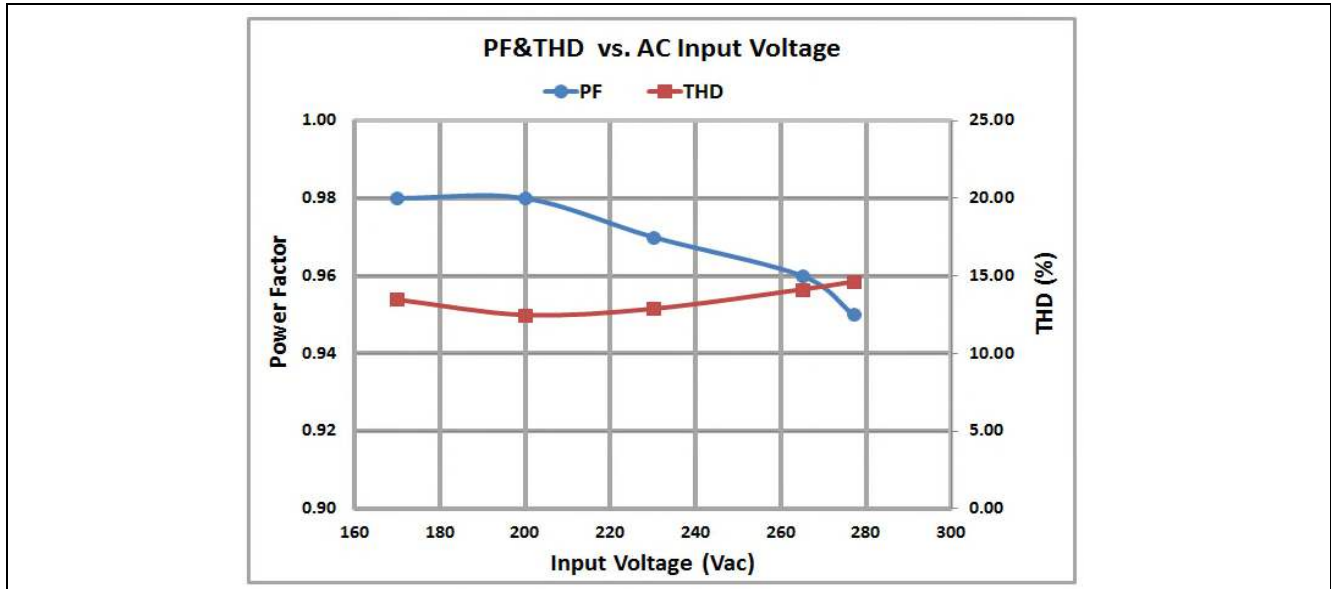

Figure 18 Power Factor and THD versus AC line voltage (66V, 270mA LED load)

9.7.2 Output current regulation

Below figure shows the LED output current versus line voltage. The output current is regulated within $\pm 2\%$ over the whole input voltage range.

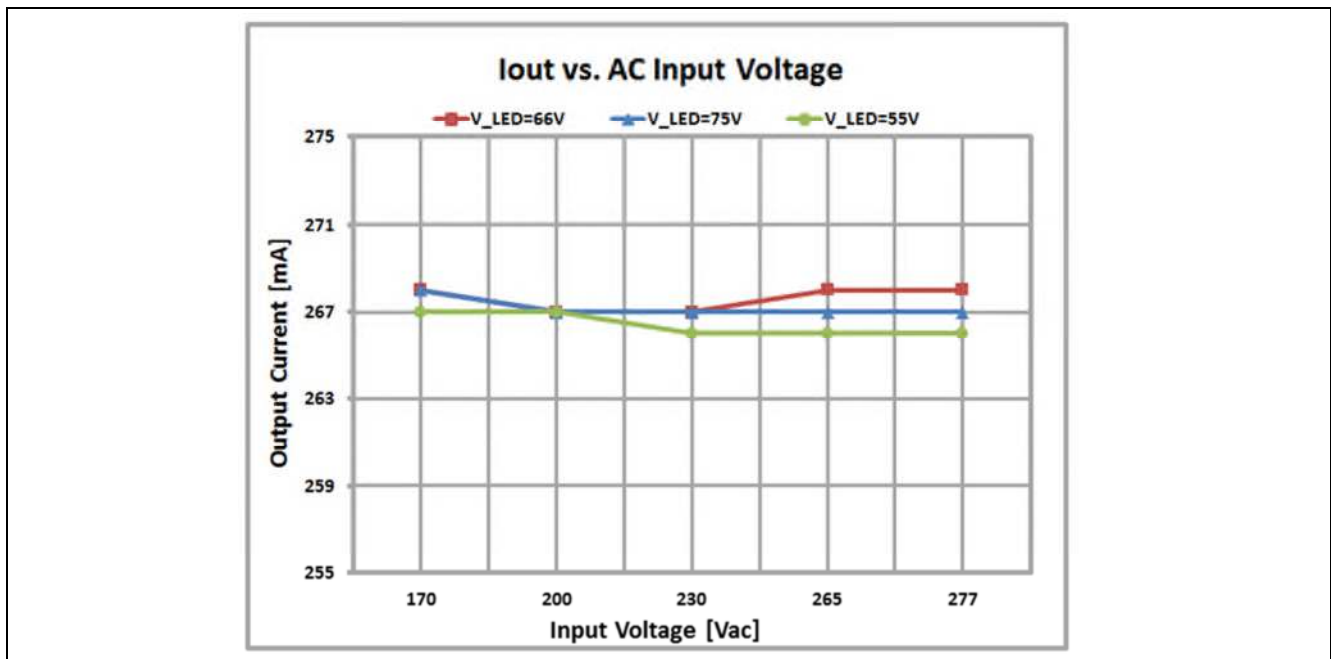

Figure 19 Output current versus AC line voltage

Reference board set up, test waveforms and results

The following figure shows the LED output current versus output voltage (LED module’s forward voltage). With the number of different LED changes, which corresponding to forward voltage of 55V, 66V and 75V, the output current is regulated within $\pm 2\%$.

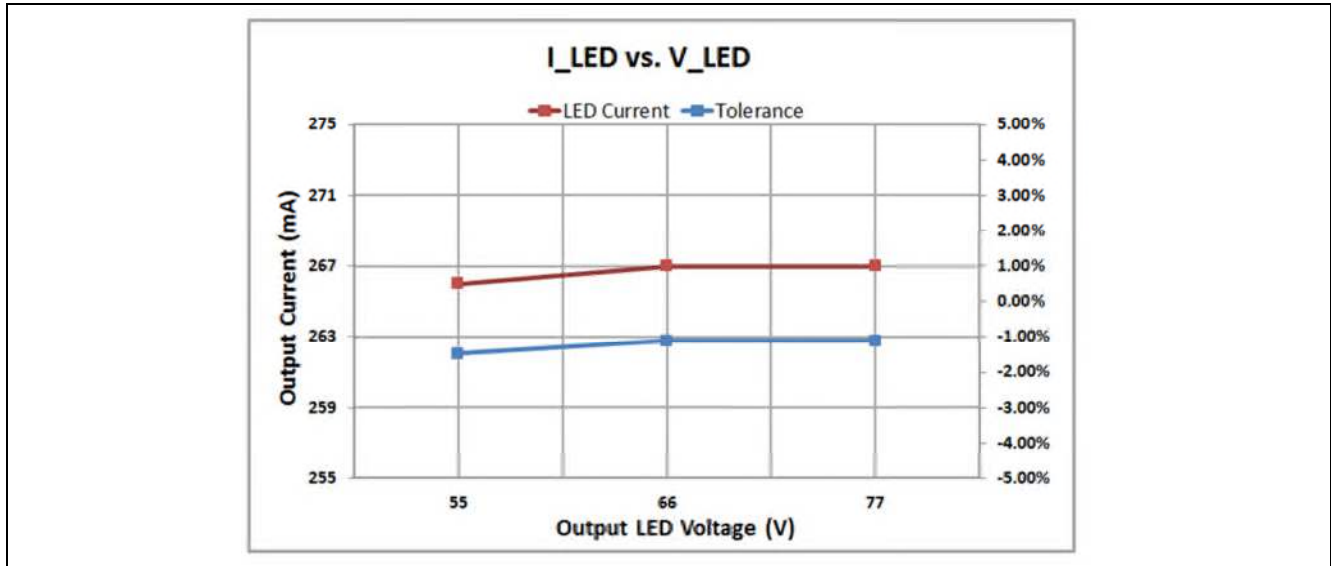

Figure 20 Output current versus output voltage ($V_{in}=230V_{AC}$, 50Hz)

9.7.3 Efficiency

The following figure shows the efficiency verses AC line voltage which exhibits $>90\%$ over the whole AC input range due to quasi resonant operation.

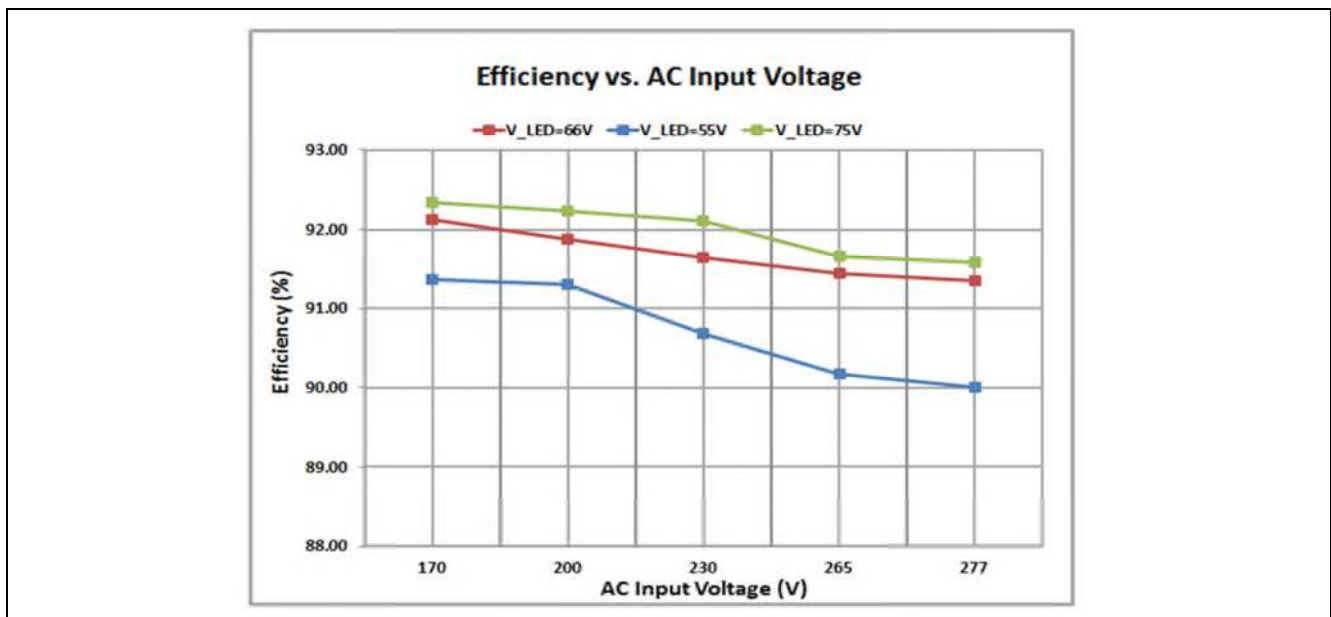

Figure 21 Efficiency versus AC line voltage

Reference board set up, test waveforms and results

9.7.4 Conducted emissions (EN55015)

The conducted emissions test was performed at 230V_{AC}, 50Hz with full load and there is approximately 10dB margin observed for both line and neutral measurements.

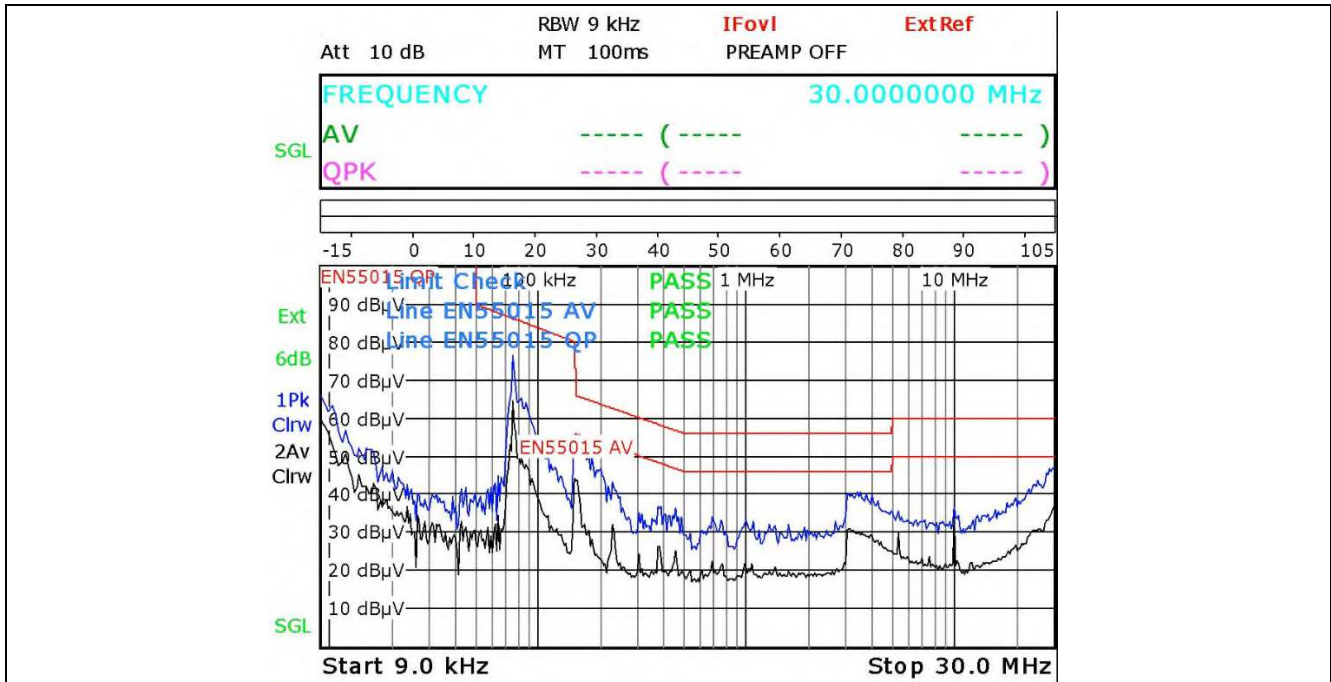

Figure 22 Conducted emissions(Line) at 230 V_{AC}, 50Hz & full load

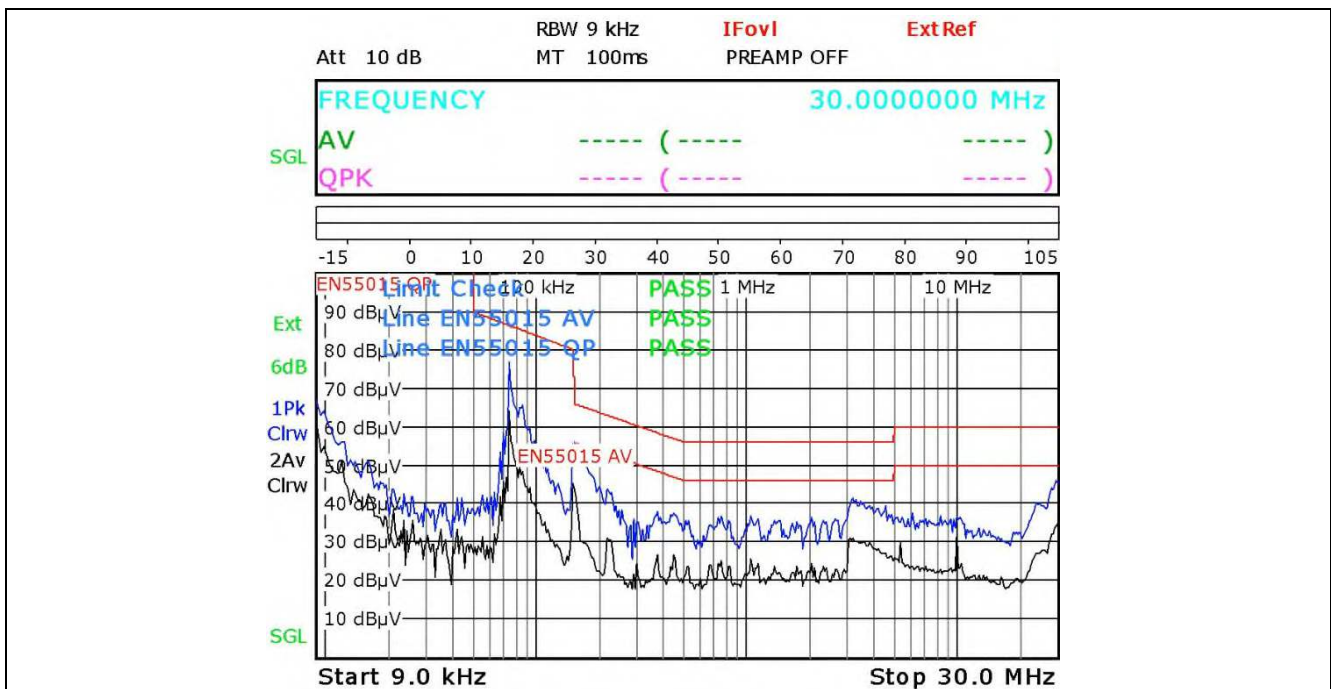

Figure 23 Conducted emissions(Neutral) at 230 V_{AC}, 50Hz & full load

9.7.5 Lightning Surge (EN61000-4-5)

The Board was subjected to $\pm 1\text{KV}$ differential mode combination wave surge at 230Vac and full load using 5 strikes at each condition, thanks to the external lightning surge improvement circuit (shown in **Figure 2**) and Infineon 650V CE MOSFET (IPS65R1K5CE), there was not any nonrecoverable interruption of output requiring supply repair or recycling of input voltage.

Table 5 Testing Results

Level (V)	Input Voltage (V)	Injection Location	Injection Phase (°)	Type	Test Results (Pass /Fail)
+1000V	230	L, N	0	Surge (2 Ω)	PASS
-1000V	230	L, N	0	Surge (2 Ω)	PASS
+1000V	230	L, N	90	Surge (2 Ω)	PASS
-1000V	230	L, N	90	Surge (2 Ω)	PASS
+1000V	230	L, N	180	Surge (2 Ω)	PASS
-1000V	230	L, N	180	Surge (2 Ω)	PASS
+1000V	230	L, N	270	Surge (2 Ω)	PASS
-1000V	230	L, N	270	Surge (2 Ω)	PASS

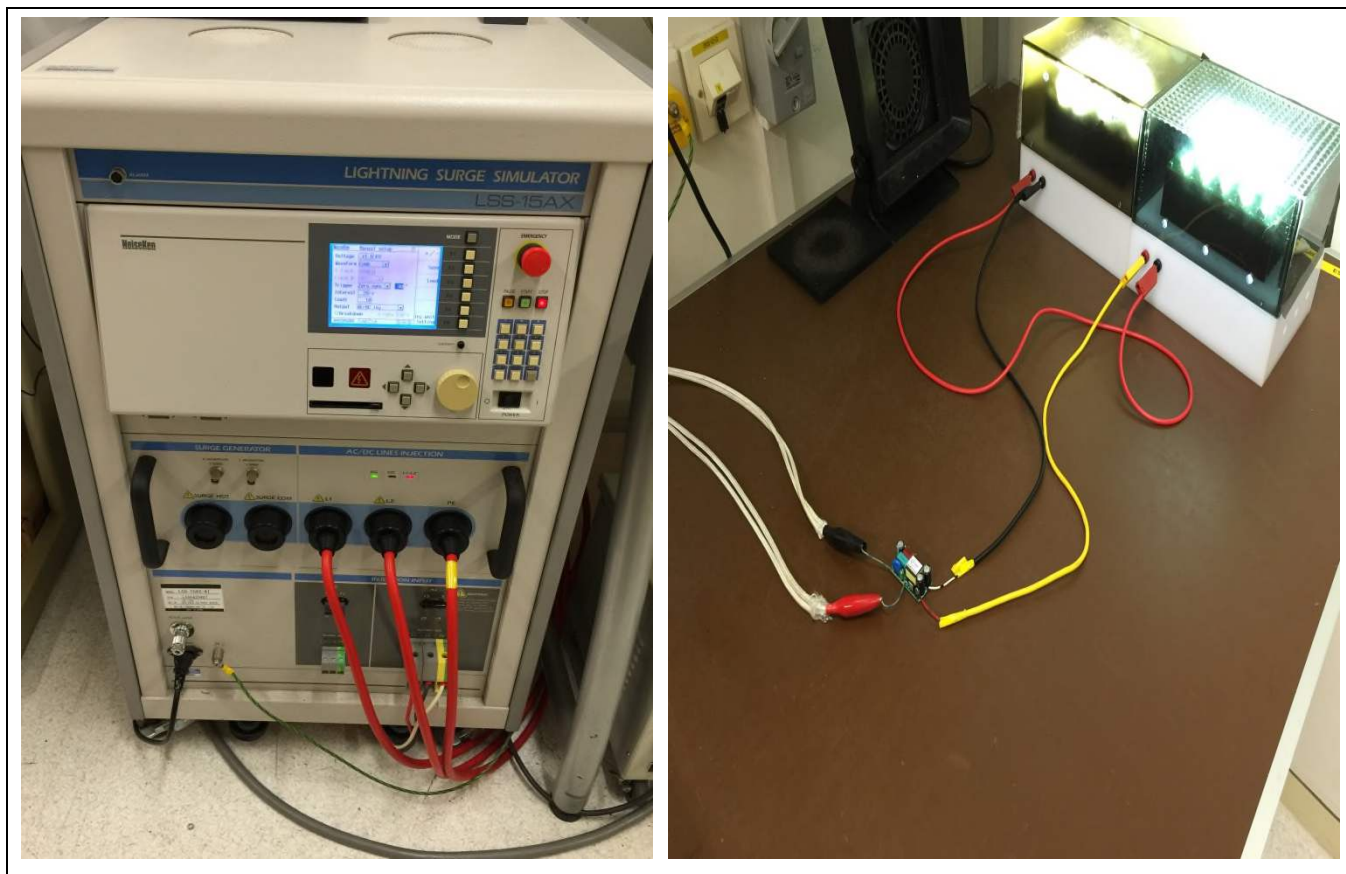

Figure 24 Testing Setup



References

10 References

- [1] ICL8201 data sheet, Infineon Technologies AG

Revision History

Major changes since the last revision

Page or Reference	Description of change

Trademarks of Infineon Technologies AG

AURIX™, C166™, CanPAK™, CIPOS™, CIPURSE™, CoolMOS™, CoolSET™, CORECONTROL™, CROSSAVE™, DAVE™, DI-POL™, EasyPIM™, EconoBRIDGE™, EconoDUAL™, EconoPIM™, EconoPACK™, EiceDRIVER™, eupec™, FCOS™, HITFET™, HybridPACK™, I²RF™, ISOFACE™, IsoPACK™, MIPAQ™, ModSTACK™, my-d™, NovalithIC™, OptiMOS™, ORIGA™, POWERCODE™, PRIMARION™, PrimePACK™, PrimeSTACK™, PRO-SIL™, PROFET™, RASIC™, Reversave™, SatRIC™, SIEGET™, SINDRION™, SIPMOS™, SmartLEWIS™, SOLID FLASH™, TEMPFET™, thinQ™, TRENCHSTOP™, TriCore™.

Other Trademarks

Advance Design System™ (ADS) of Agilent Technologies, AMBA™, ARM™, MULTI-ICE™, KEIL™, PRIMECELL™, REALVIEW™, THUMB™, μVision™ of ARM Limited, UK. AUTOSAR™ is licensed by AUTOSAR development partnership. Bluetooth™ of Bluetooth SIG Inc. CAT-iq™ of DECT Forum. COLOSSUS™, FirstGPS™ of Trimble Navigation Ltd. EMV™ of EMVCo, LLC (Visa Holdings Inc.). EPCOS™ of Epcos AG. FLEXGO™ of Microsoft Corporation. FlexRay™ is licensed by FlexRay Consortium. HYPERTERMINAL™ of Hilgraeve Incorporated. IEC™ of Commission Electrotechnique Internationale. IrDA™ of Infrared Data Association Corporation. ISO™ of INTERNATIONAL ORGANIZATION FOR STANDARDIZATION. MATLAB™ of MathWorks, Inc. MAXIM™ of Maxim Integrated Products, Inc. MICROTREC™, NUCLEUS™ of Mentor Graphics Corporation. MIPI™ of MIPI Alliance, Inc. MIPS™ of MIPS Technologies, Inc., USA. muRata™ of MURATA MANUFACTURING CO., MICROWAVE OFFICE™ (MWO) of Applied Wave Research Inc., OmniVision™ of OmniVision Technologies, Inc. Openwave™ Openwave Systems Inc. RED HAT™ Red Hat, Inc. RFMD™ RF Micro Devices, Inc. SIRIUS™ of Sirius Satellite Radio Inc. SOLARIS™ of Sun Microsystems, Inc. SPANSION™ of Spansion LLC Ltd. Symbian™ of Symbian Software Limited. TAIYO YUDEN™ of Taiyo Yuden Co. TEAKLITE™ of CEVA, Inc. TEKTRONIX™ of Tektronix Inc. TOKO™ of TOKO KABUSHIKI KAISHA TA. UNIX™ of X/Open Company Limited. VERILOG™, PALLADIUM™ of Cadence Design Systems, Inc. VLYNQ™ of Texas Instruments Incorporated. VXWORKS™, WIND RIVER™ of WIND RIVER SYSTEMS, INC. ZETEX™ of Diodes Zetex Limited.

Last Trademarks Update 2011-11-11

www.infineon.com

Edition 2015-01-23

Published by

Infineon Technologies AG

81726 Munich, Germany

© 2015 Infineon Technologies AG.

All Rights Reserved.

Do you have a question about any aspect of this document?

Email: erratum@infineon.com

Document reference

ANREF_201504_PL21_018

Legal Disclaimer

THE INFORMATION GIVEN IN THIS APPLICATION NOTE (INCLUDING BUT NOT LIMITED TO CONTENTS OF REFERENCED WEBSITES) IS GIVEN AS A HINT FOR THE IMPLEMENTATION OF THE INFINEON TECHNOLOGIES COMPONENT ONLY AND SHALL NOT BE REGARDED AS ANY DESCRIPTION OR WARRANTY OF A CERTAIN FUNCTIONALITY, CONDITION OR QUALITY OF THE INFINEON TECHNOLOGIES COMPONENT. THE RECIPIENT OF THIS APPLICATION NOTE MUST VERIFY ANY FUNCTION DESCRIBED HEREIN IN THE REAL APPLICATION. INFINEON TECHNOLOGIES HEREBY DISCLAIMS ANY AND ALL WARRANTIES AND LIABILITIES OF ANY KIND (INCLUDING WITHOUT LIMITATION WARRANTIES OF NON-INFRINGEMENT OF INTELLECTUAL PROPERTY RIGHTS OF ANY THIRD PARTY) WITH RESPECT TO ANY AND ALL INFORMATION GIVEN IN THIS APPLICATION NOTE.

Information

For further information on technology, delivery terms and conditions and prices, please contact the nearest Infineon Technologies Office (www.infineon.com).

Warnings

Due to technical requirements, components may contain dangerous substances. For information on the types in question, please contact the nearest Infineon Technologies Office. Infineon Technologies components may be used in life-support devices or systems only with the express written approval of Infineon Technologies, if a failure of such components can reasonably be expected to cause the failure of that life-support device or system or to affect the safety or effectiveness of that device or system. Life support devices or systems are intended to be implanted in the human body or to support and/or maintain and sustain and/or protect human life. If they fail, it is reasonable to assume that the health of the user or other persons may be endangered.