

51864-1 ✓ ACTIVE



PIDG

TE Internal #: 51864-1

Ring Terminals & Spade Terminals, Ring Tongue, 16 – 14 AWG

Wire Size, 1.31 – 2.08 mm² Wire Size, 2050 – 5180 CMA Wire Size,

Stud Size M4 / #8, PIDG

[View on TE.com >](#)

Terminals & Splices > Ring Terminals & Spade Terminals > PIDG Ring Tongue Terminals

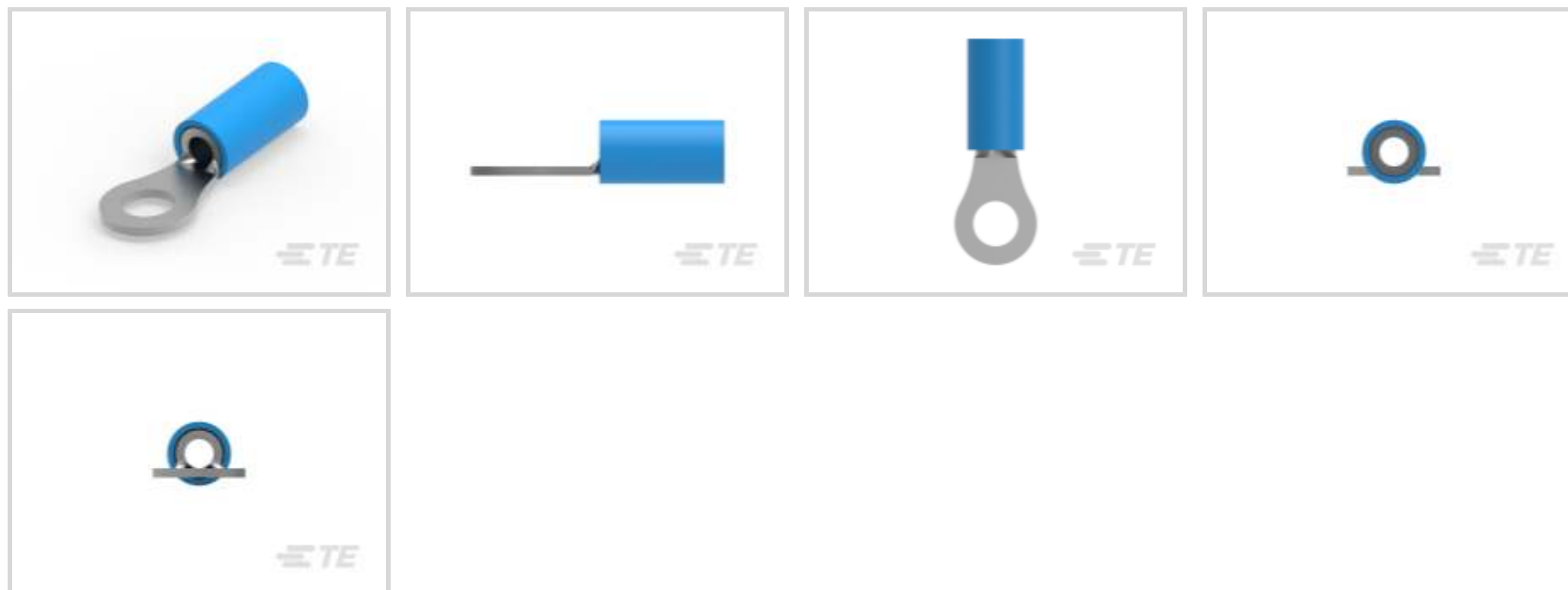

Ring & Spade Terminal Type: **Ring Tongue**

Wire Size: **2050 – 5180 CMA**

Stud Size: **#8, M4**

[All PIDG Ring Tongue Terminals \(421\)](#)

Features

Product Type Features

Stud Size	#8, M4
Sealable	No
Wire Insulation Support Retention Type	Insulation Support

Configuration Features

Number of Holes	1
-----------------	---

Electrical Characteristics

Voltage Rating	300 V
----------------	-------

Body Features

Product Weight	.986 g
Insulation Sleeve Color	Blue
Stripe Color	Blue

Contact Features

Military Part Class	Class I
---------------------	---------

Ring & Spade Terminal Type	Ring Tongue
----------------------------	-------------

Barrel Type	Closed
-------------	--------

Terminal Orientation	Straight
----------------------	----------

Terminal Plating Material	Tin
---------------------------	-----

Mechanical Attachment

Wire Insulation Support	With
-------------------------	------

Dimensions

Wire Size	2050 – 5180 CMA
-----------	-----------------

Stud Diameter	4.34 mm[.171 in]
---------------	------------------

Tongue Thickness	.79 mm[.031 in]
------------------	-----------------

Product Length	21.44 mm[.844 in]
----------------	-------------------

Compatible Insulation Diameter (Max)	3.81 mm[.15 in]
--------------------------------------	-----------------

Compatible Insulation Diameter Range	2.67 – 3.81 mm[.105 – .15 in]
--------------------------------------	-------------------------------

Usage Conditions

Insulation Option	Partially Insulated
-------------------	---------------------

Operating Temperature Range	105 °C[221 °F]
-----------------------------	----------------

Operation/Application

Compatible With Wire Base Material	Copper
------------------------------------	--------

Compatible With Wire Plating Material	Tin
---------------------------------------	-----

Industry Standards

Government Qualified Terminal	Yes
-------------------------------	-----

Packaging Features

Packaging Quantity	1000
--------------------	------

Packaging Method	Loose Piece
------------------	-------------

Product Compliance

[For compliance documentation, visit the product page on TE.com>](#)

EU RoHS Directive 2011/65/EU	Compliant
------------------------------	-----------

EU ELV Directive 2000/53/EC	Compliant
-----------------------------	-----------

China RoHS 2 Directive MIIT Order No 32, 2016	No Restricted Materials Above Threshold
-----------------------------------------------	-----------------------------------------

EU REACH Regulation (EC) No. 1907/2006	Current ECHA Candidate List: JUNE 2023 (235)
----------------------------------------	----------------------------------------------



Candidate List Declared Against: JUNE 2023 (235)

Does not contain REACH SVHC

Halogen Content

Low Halogen - Br, Cl, F, I < 900 ppm per homogenous material. Also BFR/CFR/PVC Free

Solder Process Capability

Not applicable for solder process capability

Product Compliance Disclaimer

This information is provided based on reasonable inquiry of our suppliers and represents our current actual knowledge based on the information they provided. This information is subject to change. The part numbers that TE has identified as EU RoHS compliant have a maximum concentration of 0.1% by weight in homogenous materials for lead, hexavalent chromium, mercury, PBB, PBDE, DBP, BBP, DEHP, DIBP, and 0.01% for cadmium, or qualify for an exemption to these limits as defined in the Annexes of Directive 2011/65/EU (RoHS2). Finished electrical and electronic equipment products will be CE marked as required by Directive 2011/65/EU. Components may not be CE marked. Additionally, the part numbers that TE has identified as EU ELV compliant have a maximum concentration of 0.1% by weight in homogenous materials for lead, hexavalent chromium, and mercury, and 0.01% for cadmium, or qualify for an exemption to these limits as defined in the Annexes of Directive 2000/53/EC (ELV). Regarding the REACH Regulation, the information TE provides on SVHC in articles for this part number is based on the latest European Chemicals Agency (ECHA) 'Guidance on requirements for substances in articles' posted at this URL: <https://echa.europa.eu/guidance-documents/guidance-on-reach>

Compatible Parts



TE Part # 58433-3
PRO CR ASSY, RBY IS9252



TE Part # 59250
T-HEAD PIDG 26-14 ASSY



TE Part # 47387
DAHT PG PIDG 20-14 ASSY



TE Part # 58423-1
DIE, RBY IS9252



TE Part # 47387-7
DAHT PG PIDG 16-12 ASSY



TE Part # 59824-1
TETRA-CRIMP PIDG PG FASTON 22-10 ASSY



TE Part # 525691
DAHT PG PIDG 16-14 ASSY



TE Part # 539691-2
ERGO DIE R.B.Y

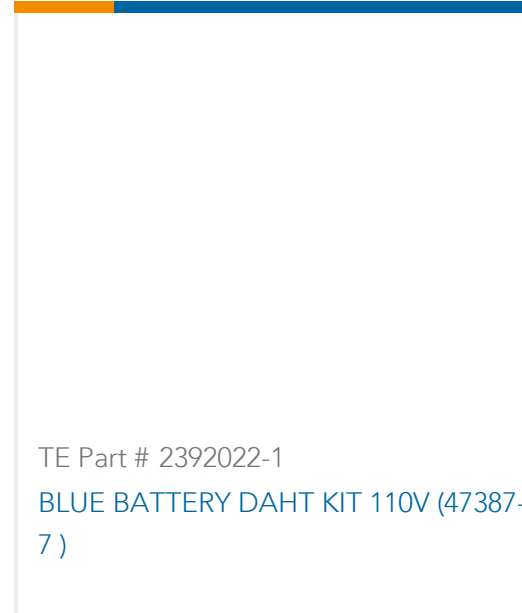
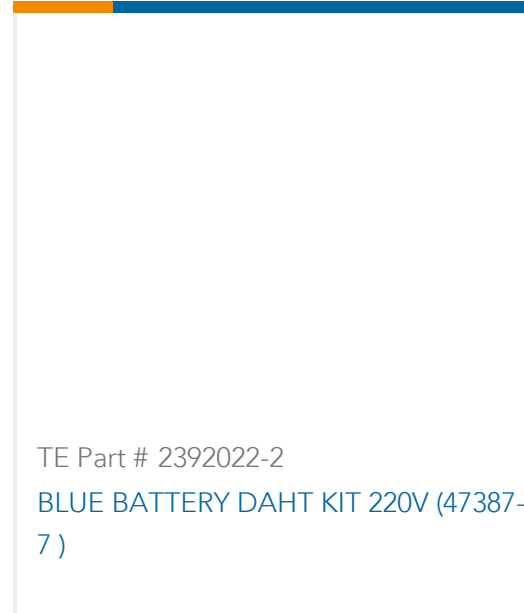
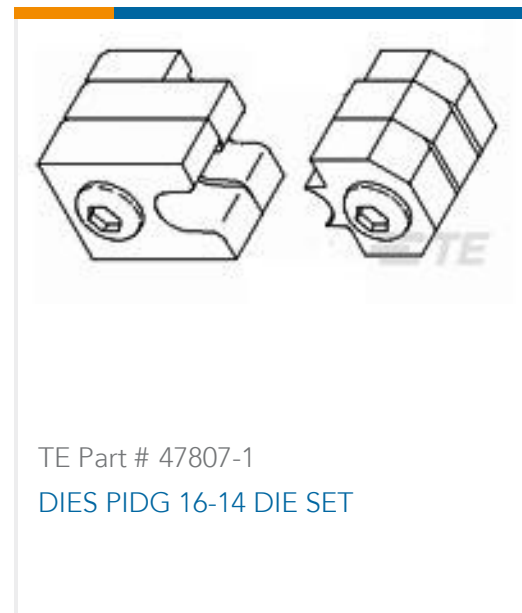

Also in the Series | PIDG

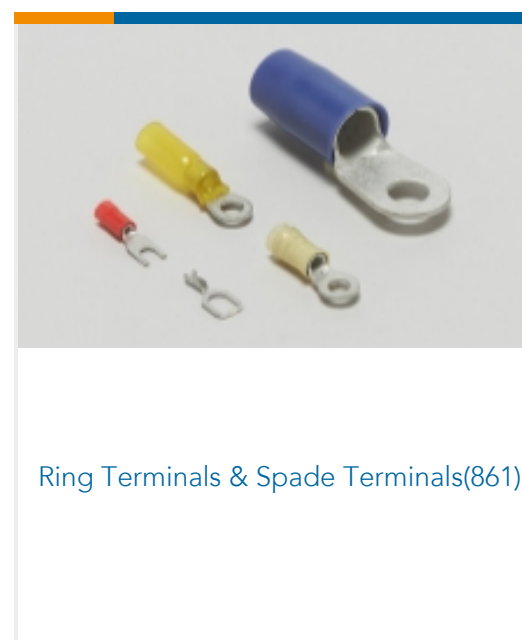
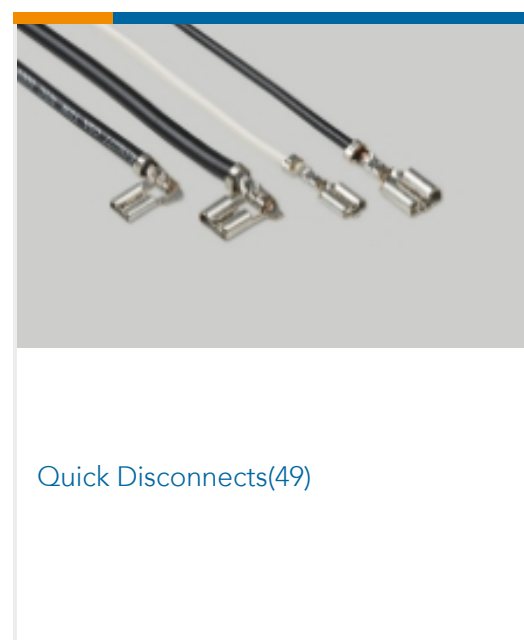
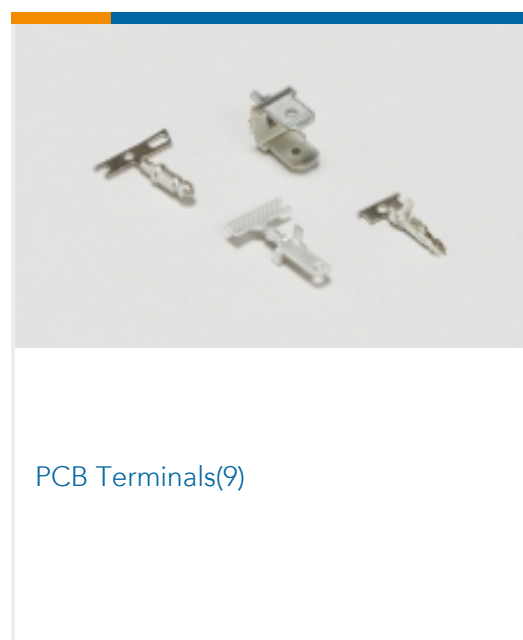
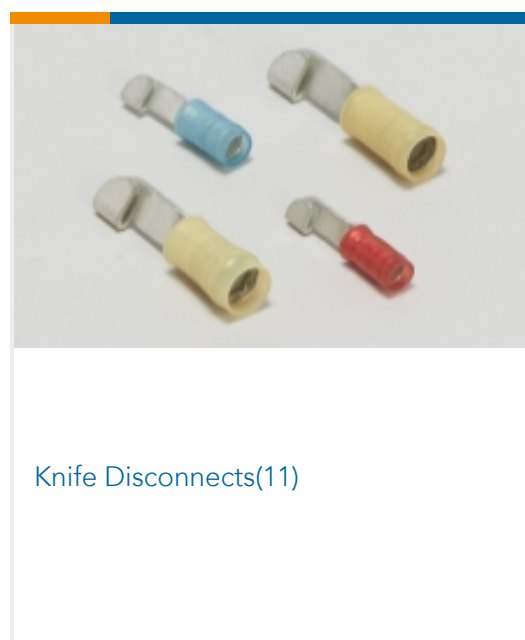
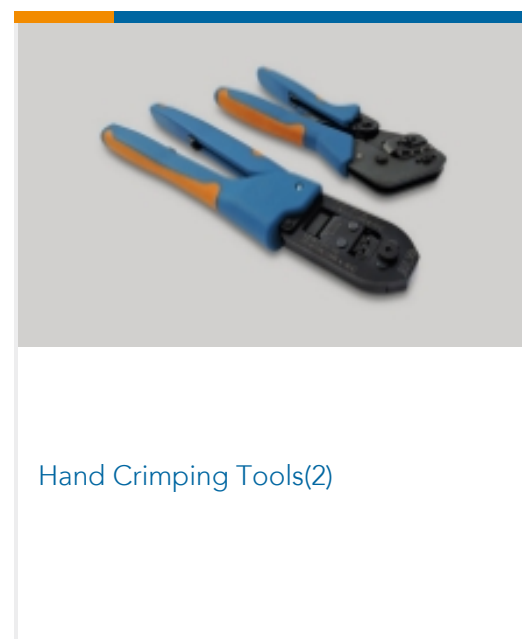
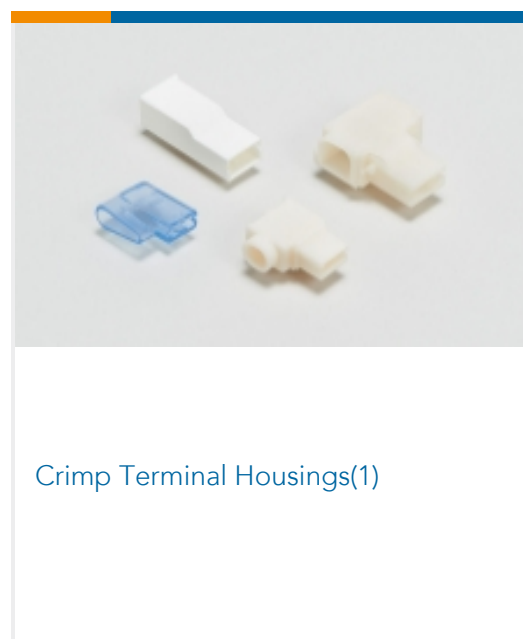
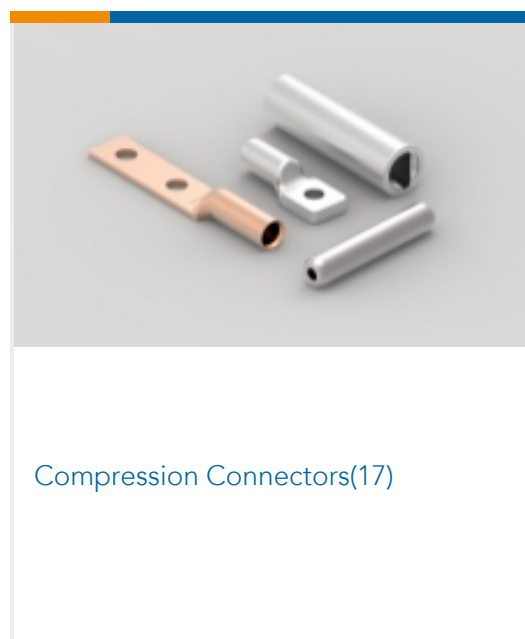

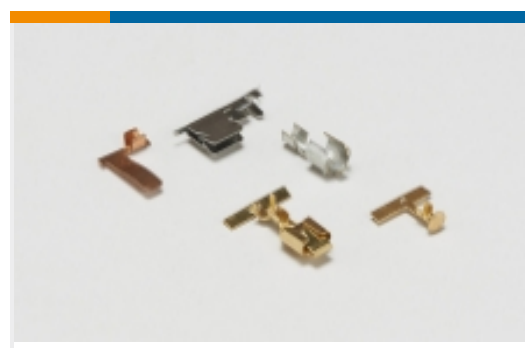

Special Purpose Terminals(1)



Splices(47)

Customers Also Bought

TE Part #320563
PIDG Ring Tongue TerminalsTE Part #A21720-000
DWP-125-3/8-2-50MMTE Part #189721-1
HAND NON-LOGIC POWER UNITTE Part #49592
DAHT SOLIS 14-12 ASSY

Documents

Product Drawings

TERM, RT, PIDG, 16-14, #8

English

CAD Files

3D PDF

3D

Customer View Model

ENG_CVM_CVM_51864-1_AF.2d_dxf.zip

English

Customer View Model

ENG_CVM_CVM_51864-1_AF.3d_igs.zip

English

Customer View Model

ENG_CVM_CVM_51864-1_AF.3d_stp.zip

English

By downloading the CAD file I accept and agree to the [Terms and Conditions](#) of use.

Datasheets & Catalog Pages

PIDG TERMINALS & SPLICES Quick Reference Guide

English

Product Specifications

Application Specification

English



Product Environmental Compliance

[MD_51864-1_05042018652_dmtec](#)

English

[MD_51864-1_05042018652_dmtec](#)

English

Agency Approvals

[UL Report](#)

English