



TAOGLAS®



Datasheet

Part No:
AGPSF.36C.07.0100C

Description:

Embedded Active GPS L1/L2 Stacked Patch Antenna
with 100mm 1.37 coax cable and IPEX MHFHT

Features:

Covers:

- GPS/QZSS (L1/L2)
- Galileo (E1/E5b)

Low Noise Figure

Excellent Out-Of-Band Rejection

Low Axial Ratio

2 Stage LNA and SAW filter

Cable: 100mm 1.37 Coaxial Cable

Connector: IPEX MHFHT (U.FL Compatible)

Dimensions: 35*35*11.1mm

RoHS and REACH Compliant

1. Introduction	3
2. Specifications	4
3. Antenna Characteristics	6
4. Radiation Patterns	18
5. Field Test Results	20
6. Mechanical Drawing	21
7. Packaging	22
8. Application Note	23
<hr/>	
Changelog	24

Taoglas makes no warranties based on the accuracy or completeness of the contents of this document and reserves the right to make changes to specifications and product descriptions at any time without notice. Taoglas reserves all rights to this document and the information contained herein. Reproduction, use or disclosure to third parties without express permission is strictly prohibited.



1. Introduction



The Taoglas AGPSF.36C, with Taoglas Sure Technology, is an active, embedded stacked patch, GPS antenna supporting both L1 and L2 bands. It is a high performance, economical solution for the highest accuracy centimeter-level tracking applications.

Typical applications include:

- UAVs and Robotics
- E-Mobility and E-Scooters
- Precision Agriculture
- Navigation

This compact antenna exhibits excellent radiation patterns on both L1 and L2 bands and with a low noise figure to preserve signal quality helps minimize time to first fix. It also features excellent out-of-band rejection to prevent out-of-band signals from overdriving or damaging its LNAs.

The AGPSF.36C features very tight Phase Centre Offset (PSO) at just $\pm 2\text{cm}$ at the L1 Band and $\pm 5\text{cm}$ at the L2. The precision of antenna phase center directly affects the accuracy of GNSS positioning systems and can ensure that the accuracy of the receiver really is cm level. See section 3.1.2 for more information and results.

This antenna has been tuned and tested on a 70 X 70 mm ground plane, working at GPS L1, 1575.42 MHz and L2, 1227.6MHz, with a 2 stage LNA ensuring good signal strength. It can operate with an input voltage ranging from 1.8 to 5 volts.

Cables and connectors are customizable. Patch antennas can also be tuned to customer-specific device environments, subject to NRE and MOQ. Contact your regional Taoglas customer support team to request these services or additional support to integrate and test this antenna's performance in your device.

2. Specifications

GNSS Frequency Bands Covered						
GPS	L1	L2	L5			
	■	■	□			
GLONASS	G1	G2	G3			
	□	□	□			
Galileo	E1	E5a	E5b	E6		
	■	□	■	□		
BeiDou	B1	B2a	B2b	B3		
	□	□	□	□		
QZSS (Regional)	L1	L2C	L5	L6		
	■	■	□	□		
IRNSS (Regional)	L5					
	□					
SBAS	L1/E1/B1	L5/B2a/E5a	G1	G2	G3	
	■	□	■	□	□	

■ GNSS Frequency Bands Covered. □ GNSS Frequency Bands Not Covered.

*SBAS systems: WASS(L1/L5), EGNOS(E1/E5a), SDCM(G1/G2/G3), SNAS(B1,B2a), GAGAN(L1/L5), QZSS(L1/L5), KAZZ(L1/L5).

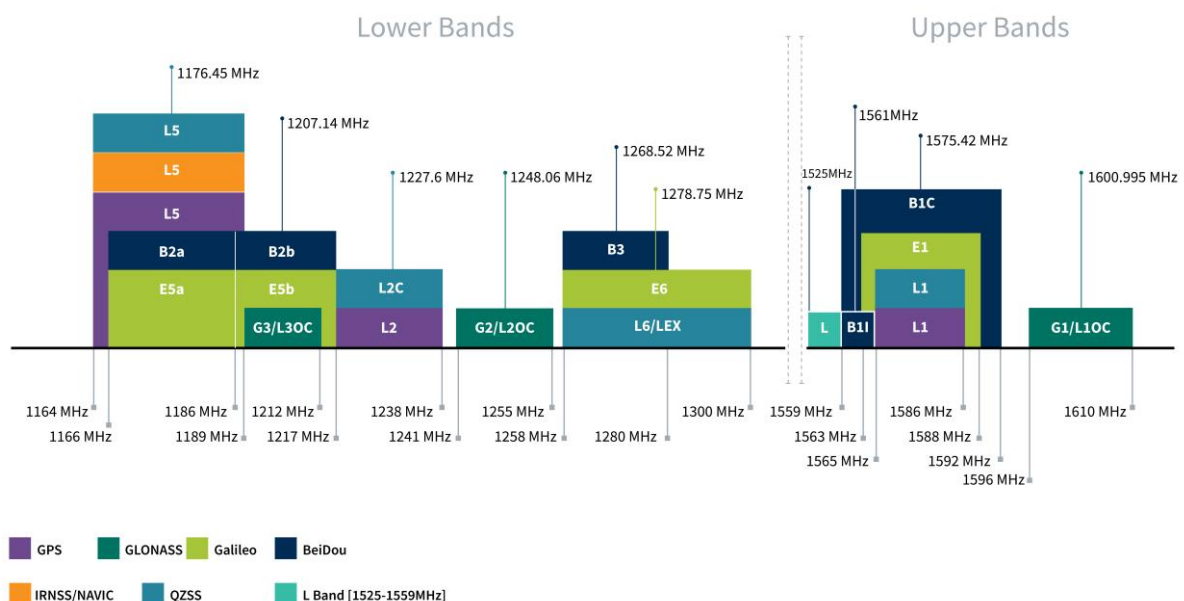

GNSS Bands and Constellations

GPS L1 & L2 Antenna		
	GPS L1	GPS L2
Center Frequency	1575.42MHz	1226.7MHz
Return loss (dB)	<-10	<-10
Efficiency (%)	68.74	64.16
Peak Gain (dBi)	3.57	2.73
Axial Ratio at Zenith	<1.5dB	<5dB
Group Delay	12	20
PCO (cm)	5	4.5
PCV (cm)	0.07	4.5
Impedance	50 Ω	
Polarization	RHCP	

*Tested on 70x70 cm ground plane

LNA and Filter Electrical Properties	
Center Frequency	GPS L1 :1575.42±1.023 MHz GPS L2:1226.7±1.023MHz
Pout 1dB gain Compression point	+2dBm Typ. (1575.42MHz) -2dBm Typ. (1226.7MHz)
Output Impedance	50 Ohm
Return loss (dB)	<-10 dB

LNA Gain, Power Consumption and Noise Figure					
		1.8V (Min)	3V (Typ.)	5.5V (Max)	
LNA Gain	L2	20dB	20dB	20dB	
	L1	21dB.	21dB	21dB	
Noise Figure	L1	2.6dB	2.6dB	2.6dB	
	L2	3.0dB	3.0dB	3.0dB	
Current Consumption		16mA	16mA	16mA	
Outer Band Attenuation		100MHz~1180MHz	40dB		
		1280MHz~1520MHz	30dB		
		1620MHz~6000MHz	45dB		

Mechanical	
Dimensions	35x35x11mm
Cable	Coaxial Cable Ø1.37, length 100mm
Connector	IPEX MHFI (U.FL)
Weight	32g

Environmental	
Operation Temperature	-40°C to 85°C
Storage Temperature	-40°C to 85°C
Humidity	Non-condensing 40°C 95% RH
RoHS Compliant	Yes
REACH Compliant	Yes

3. Antenna Characteristics

3.1 Block Diagram (Active Antenna)

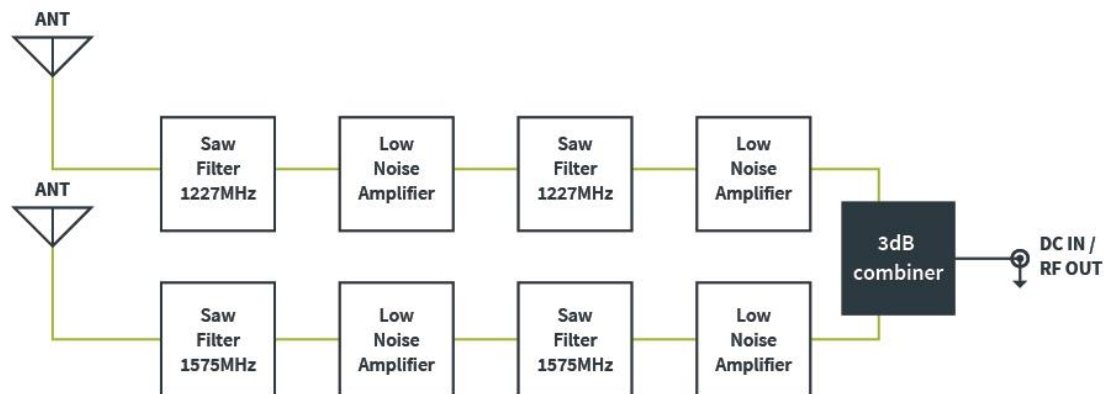

3.2 Phase Centre Offset

The antenna reference point (ARP) is defined as the intersection of antenna's vertical axis of symmetry with the bottom of the antenna. The antenna reference point is typically the point on the center-line of the antenna at the mounting surface. Above the antenna reference point is the mechanical antenna phase center, this is the physical point on the surface of the antenna element where the antenna phase is located. The actual antenna phase center are points in space, typically above the mechanical antenna phase center.

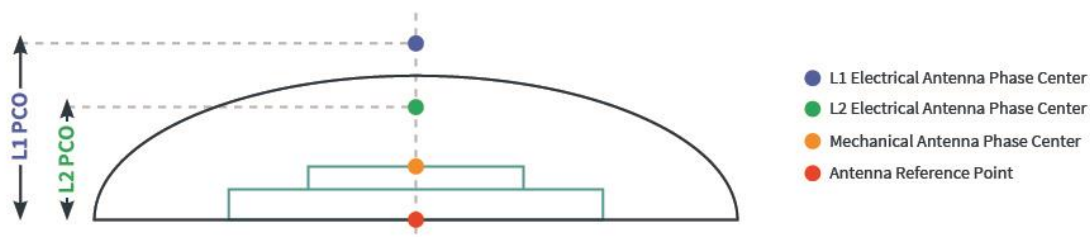

The precision of antenna phase center directly affects accuracy of GNSS positioning systems. Single-band and dual-band RTK GNSS receiver systems depend on Phase Centre Offset (PCO) correction input at the receiver to improve accuracy of the receiver to cm level. Thus PCO data is required for GPS post processing at the receiver in real time or at a later stage using post processing software once data has been transferred to a PC.

By using the carrier phase data of L1 and L2 signals, cm level precision is possible with PCO correction. Single-band and dual-band RTK systems depend on PCO correction input at the receiver to improve accuracy of the receiver to cm level.

AGPSF.36C.07.0100C L1 Phase Centre Offset Measurements

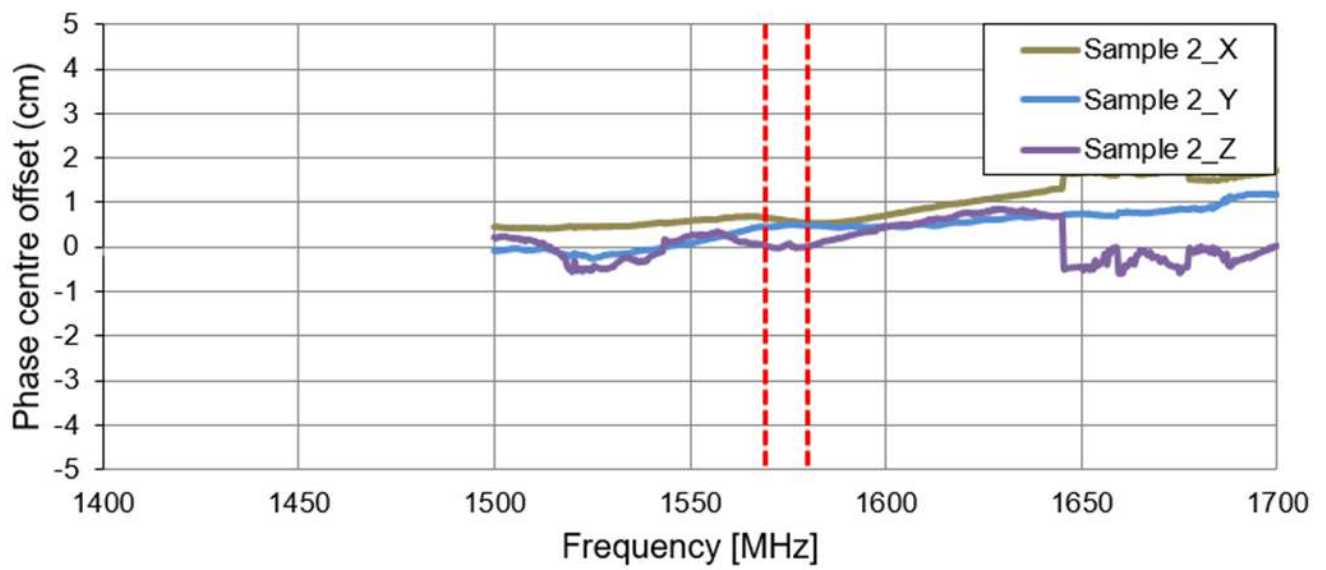
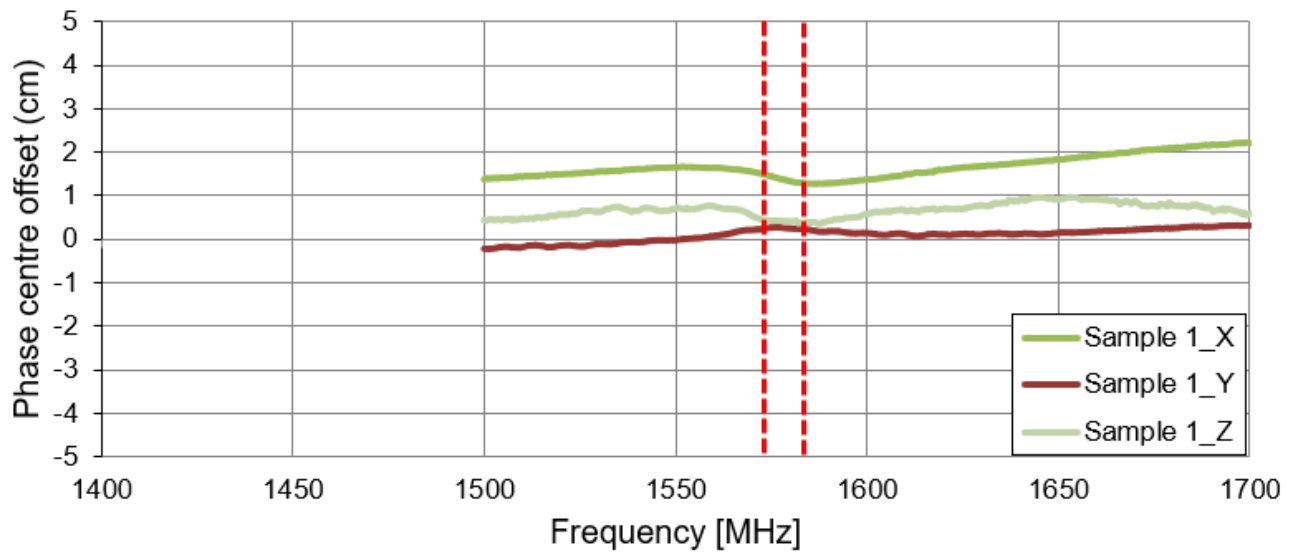

AGPSF.36C.07.0100C L2 Phase Centre Offset Measurement

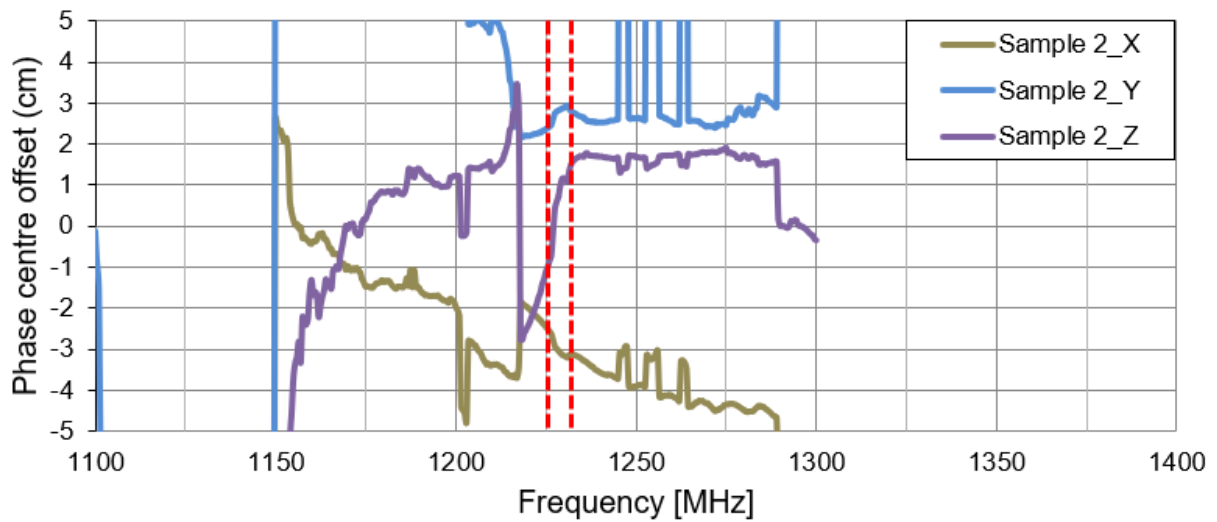
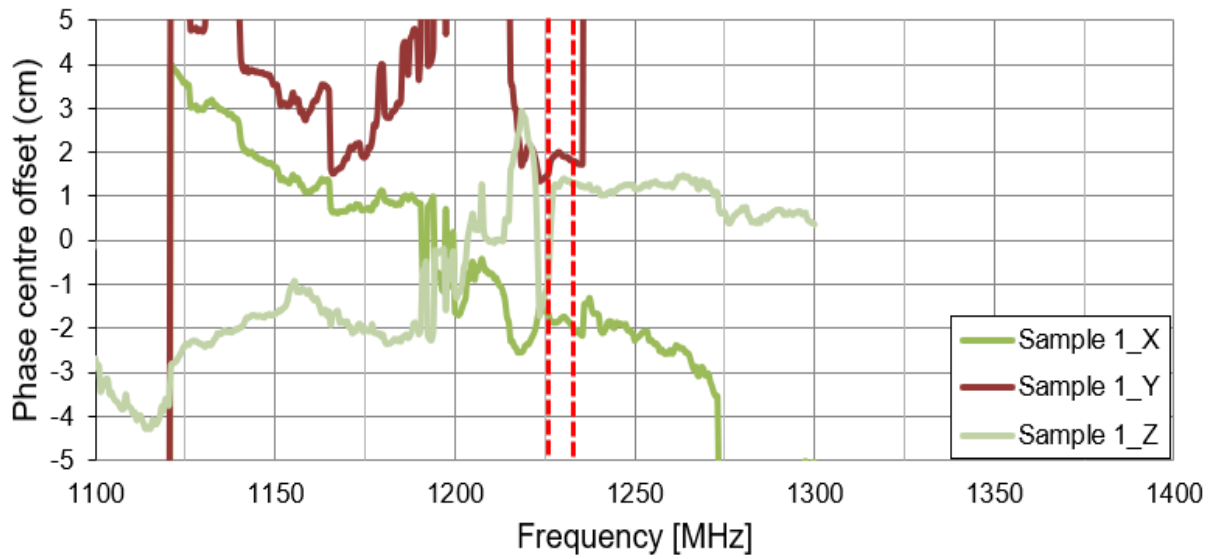

In addition to phase center location, the residual error is the mean of the difference between actual observed phase center and the predicted values. The smaller the residual error (typically less than 2 degrees) the better accuracy of the antenna due to good phase stability.

AGPSF.36C.07.0100C L1 Residual Error

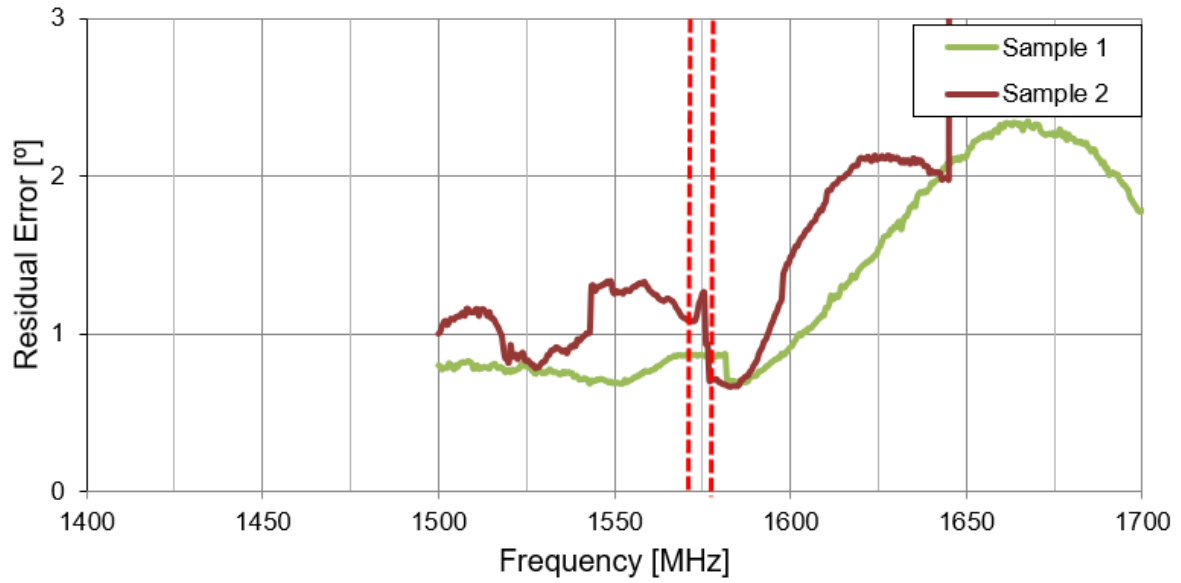

AGPSF.36C.07.0100A L2 Residual Error

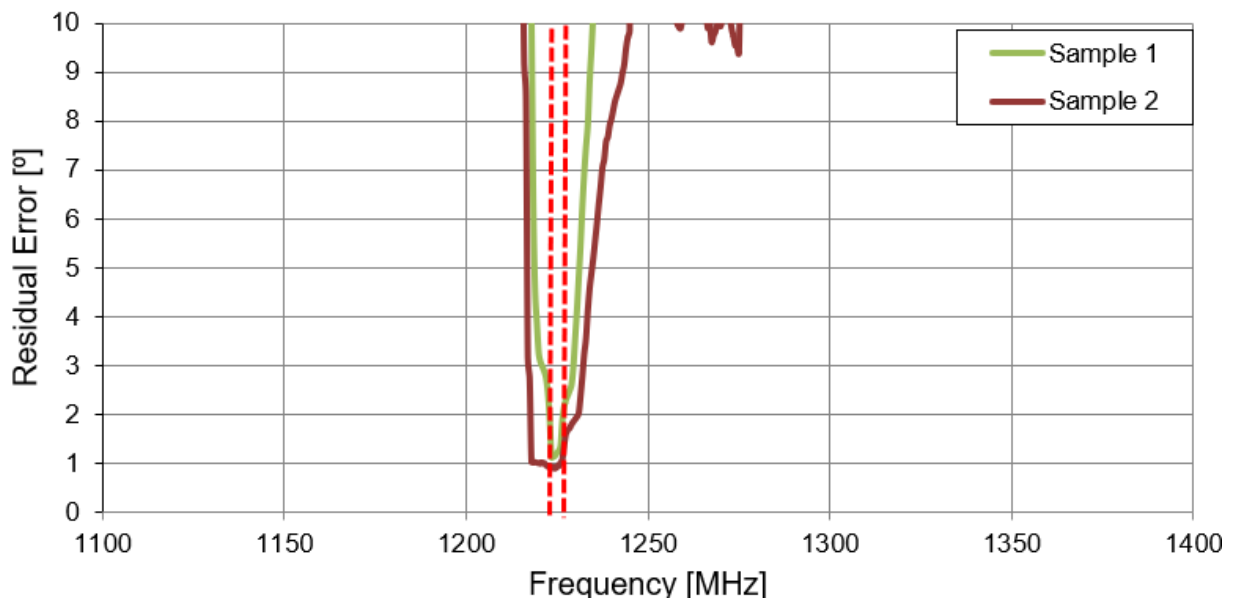

3.3 Return Loss (Passive antenna)

L1 1575MHz

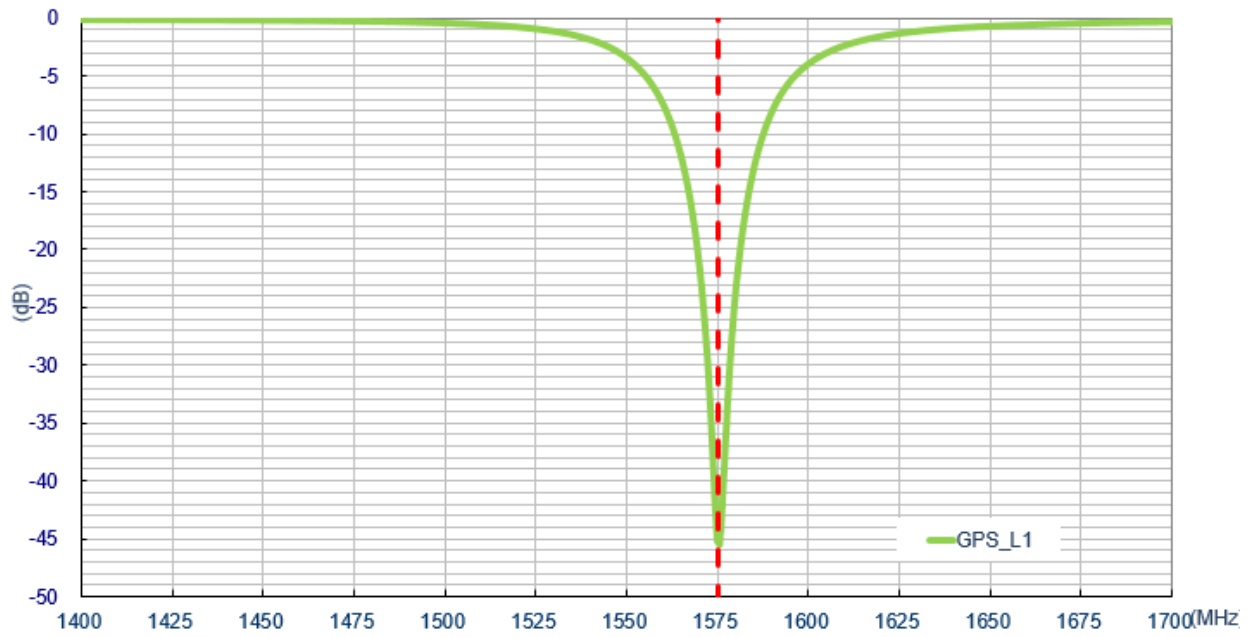

L2 1227MHz

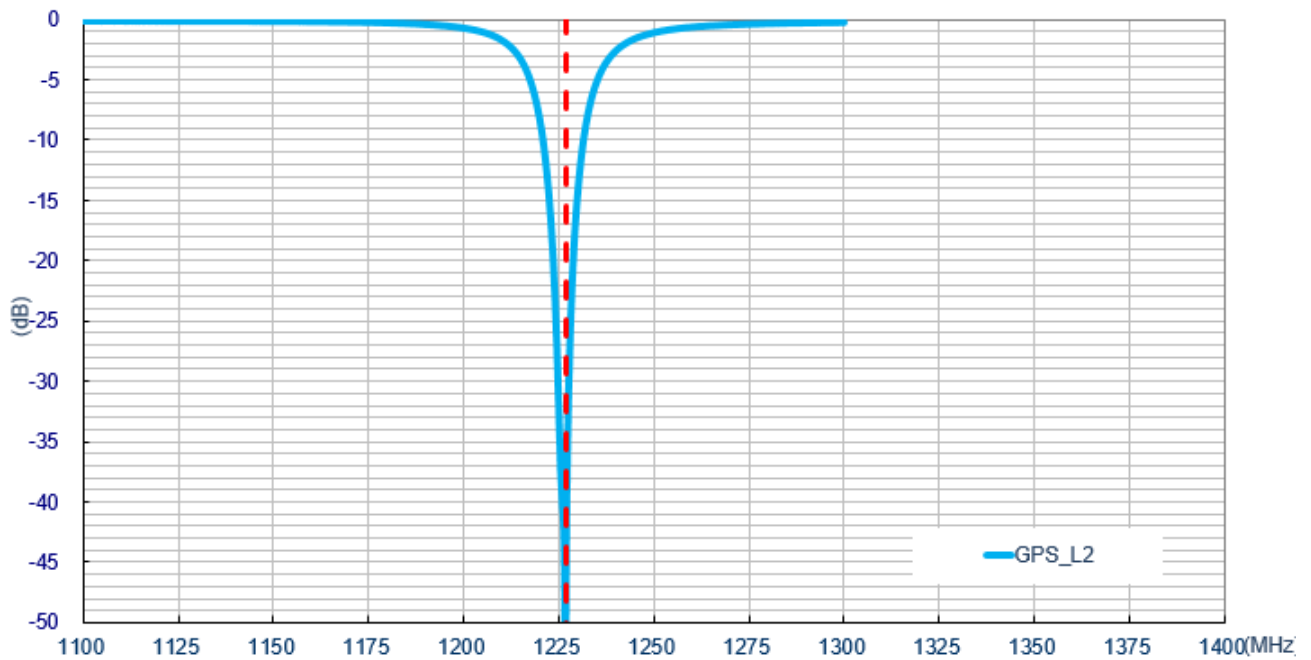

3.4 Efficiency (Passive antenna)

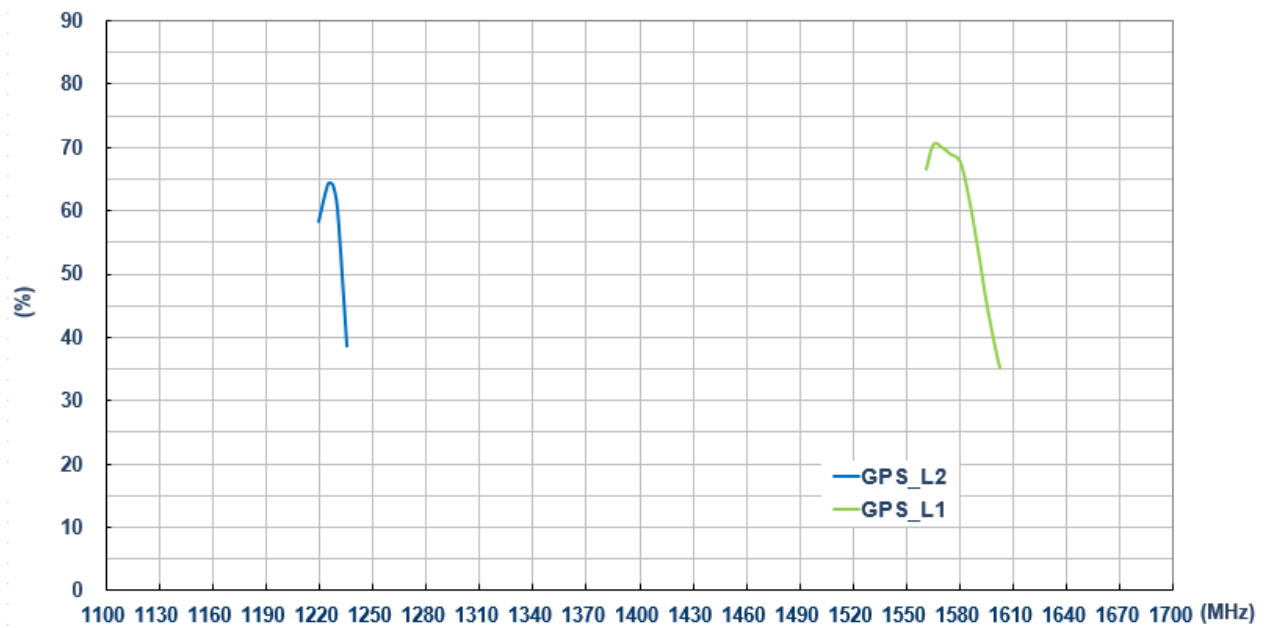

3.5 Average Gain (Passive antenna)

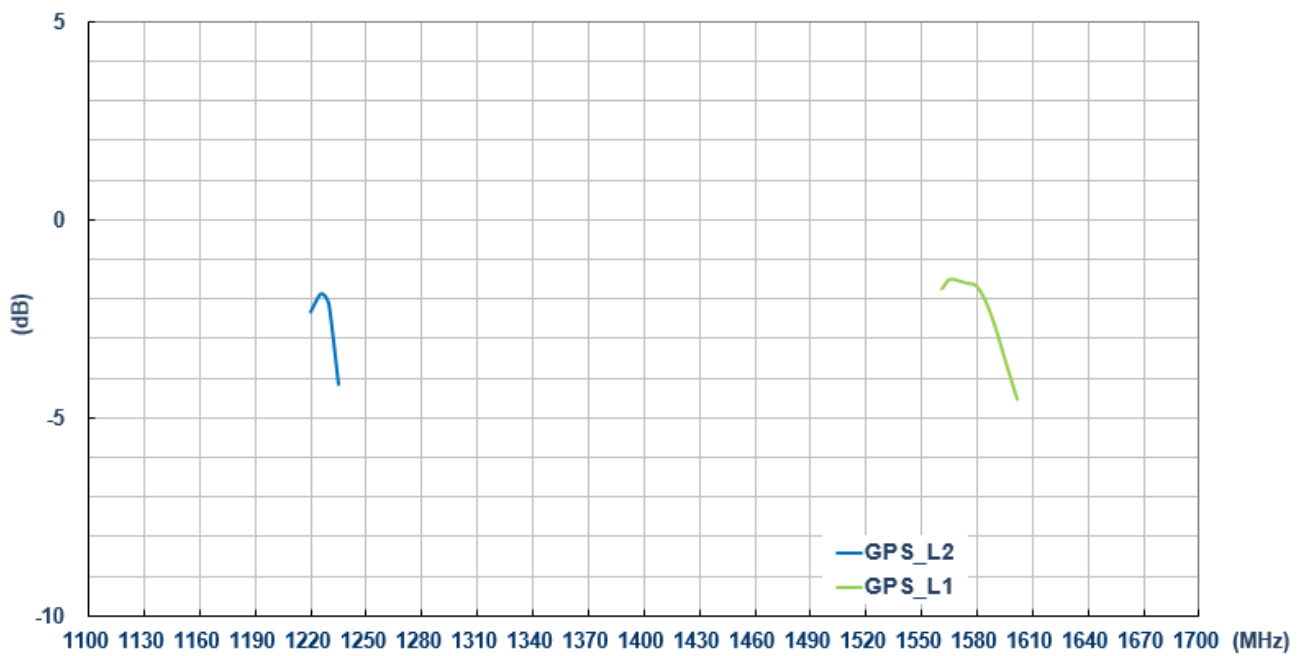

3.6 Peak Gain (Passive antenna)

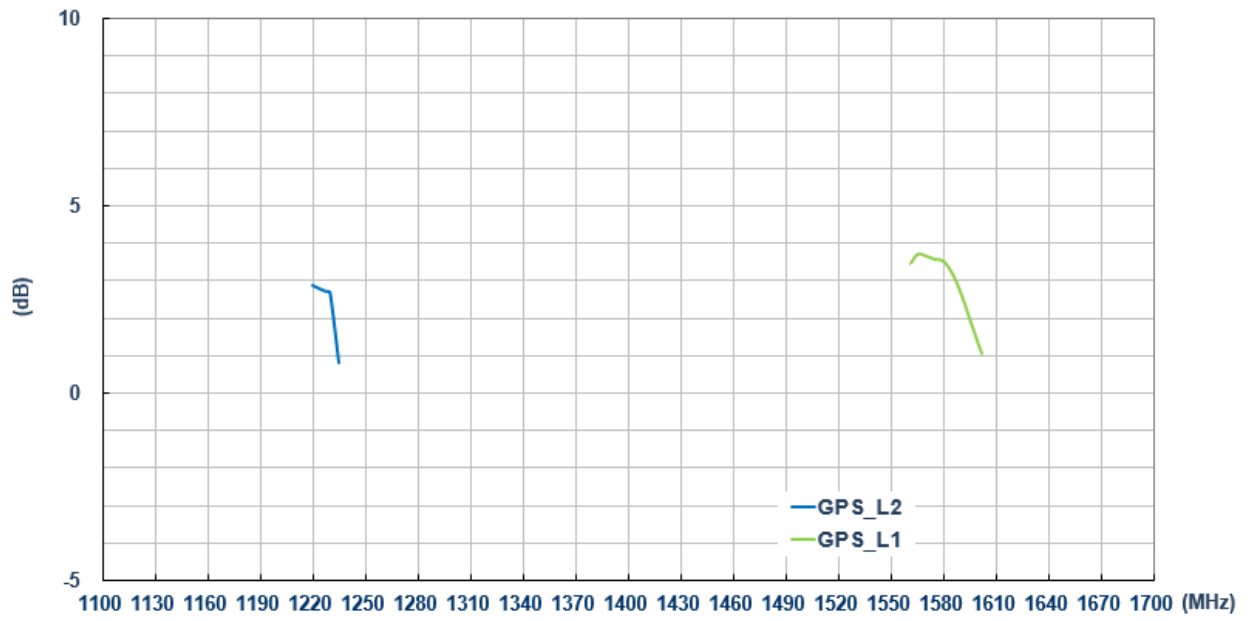

3.7 Axial Ratio Pattern (Zenith is at 0°)

YZ plane

L1 1575MHz

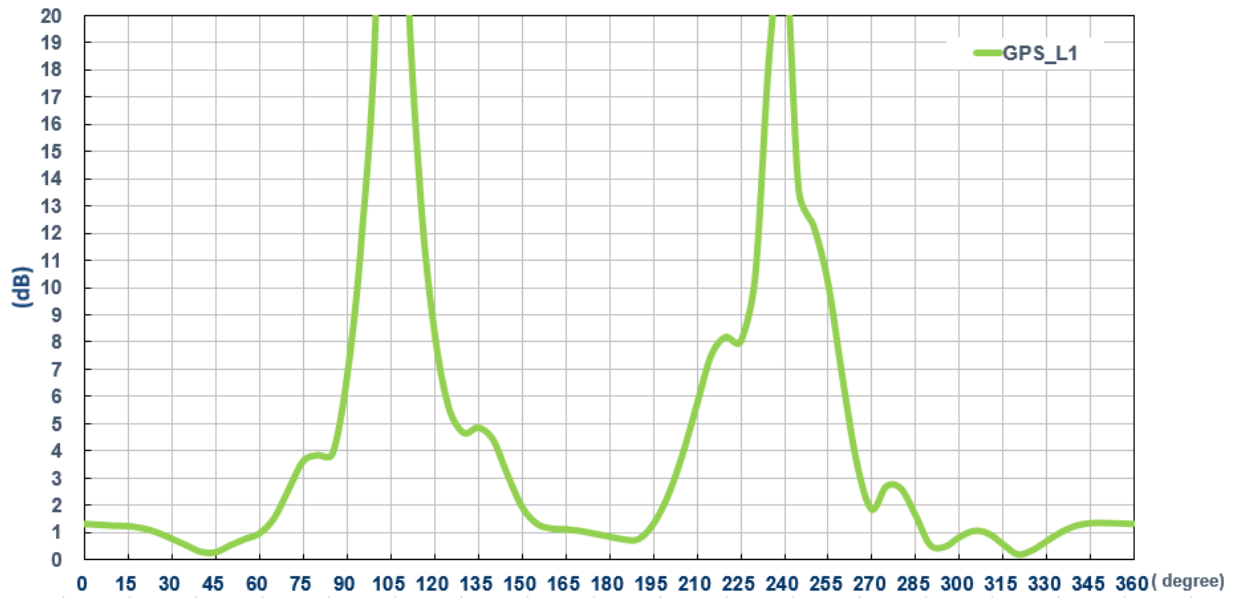

L2 1227MHz

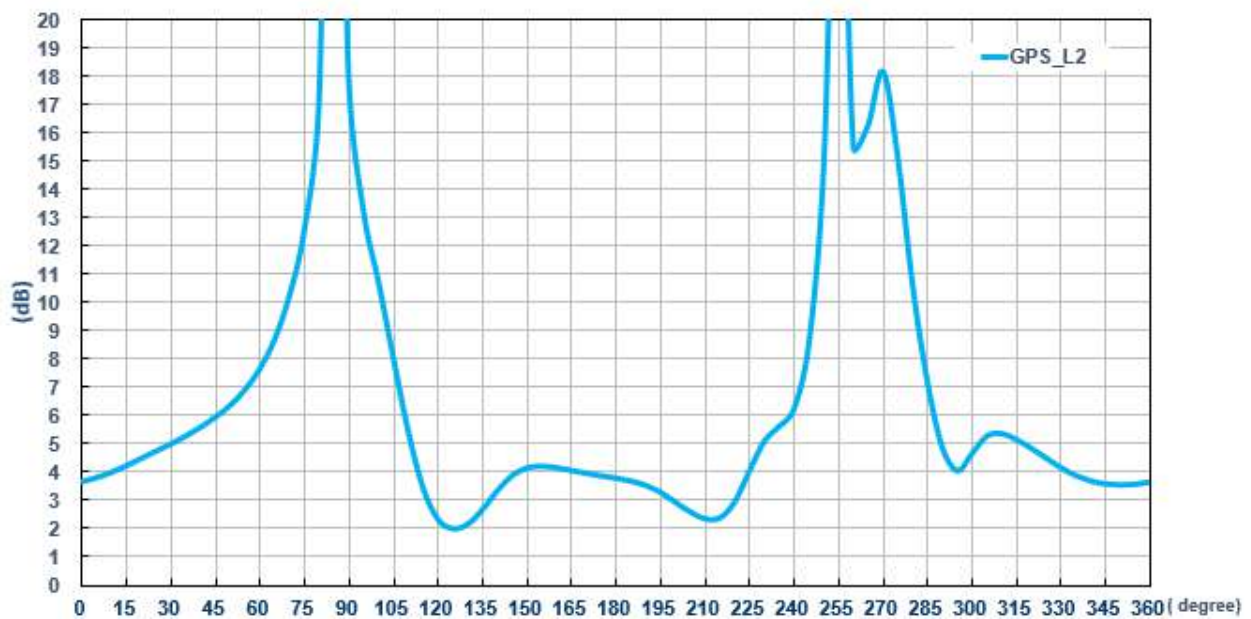

XZ plane

L1 1575MHz

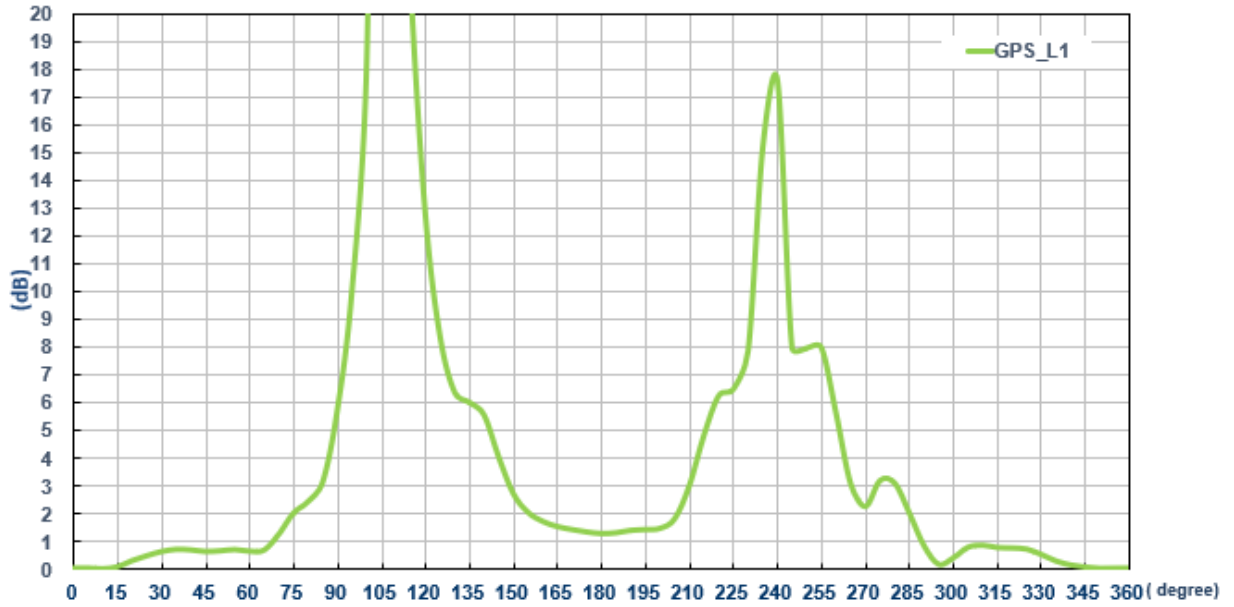

L2 1227MHz

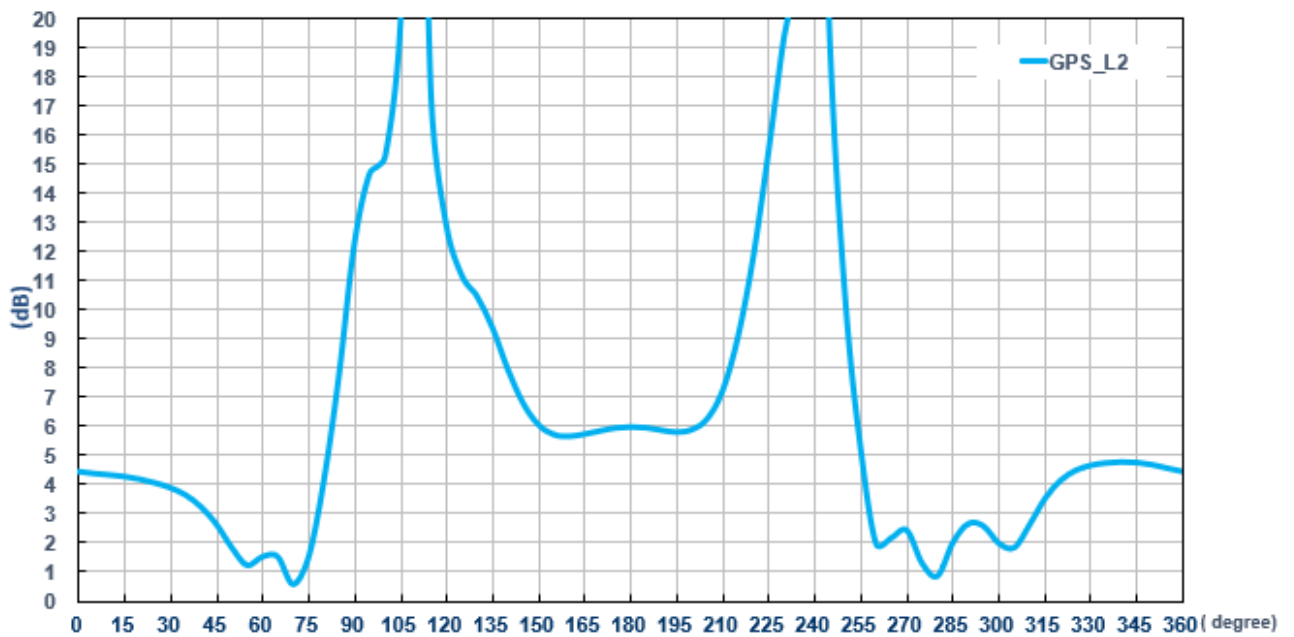

3.8 LNA Gain and Noise Figure (Active antenna)

L1 1575MHz

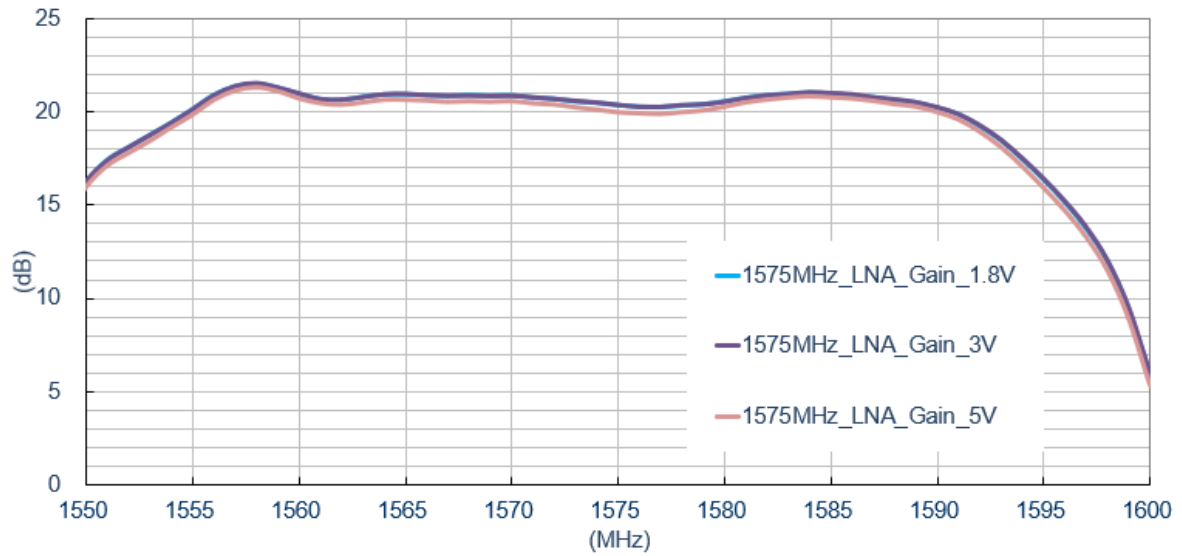

L2 1227MHz

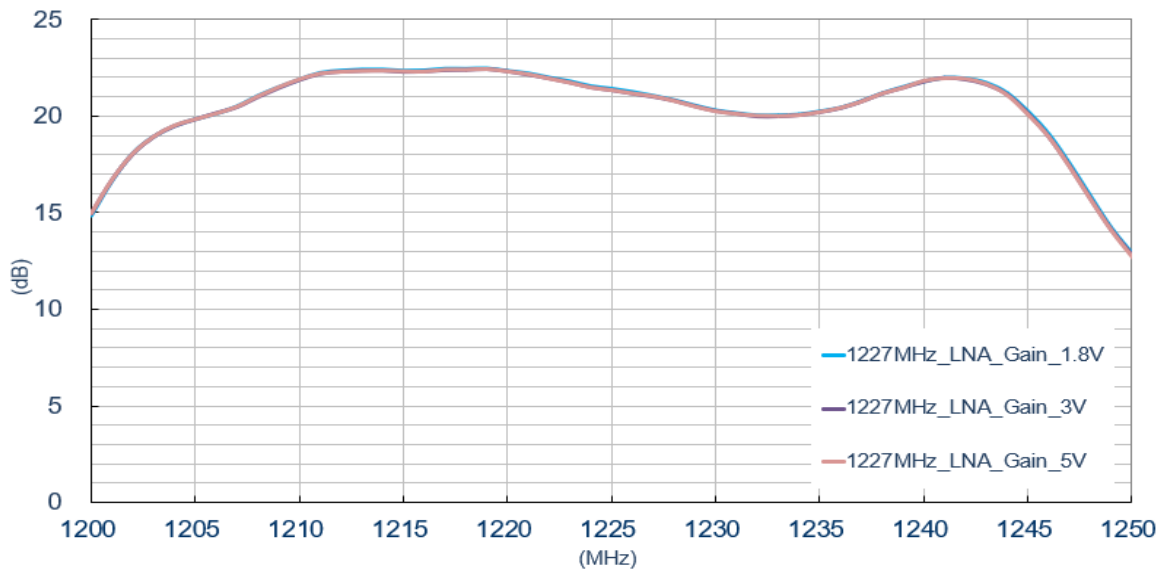

3.9 S12 Wide Band Plot

L1 1575MHz

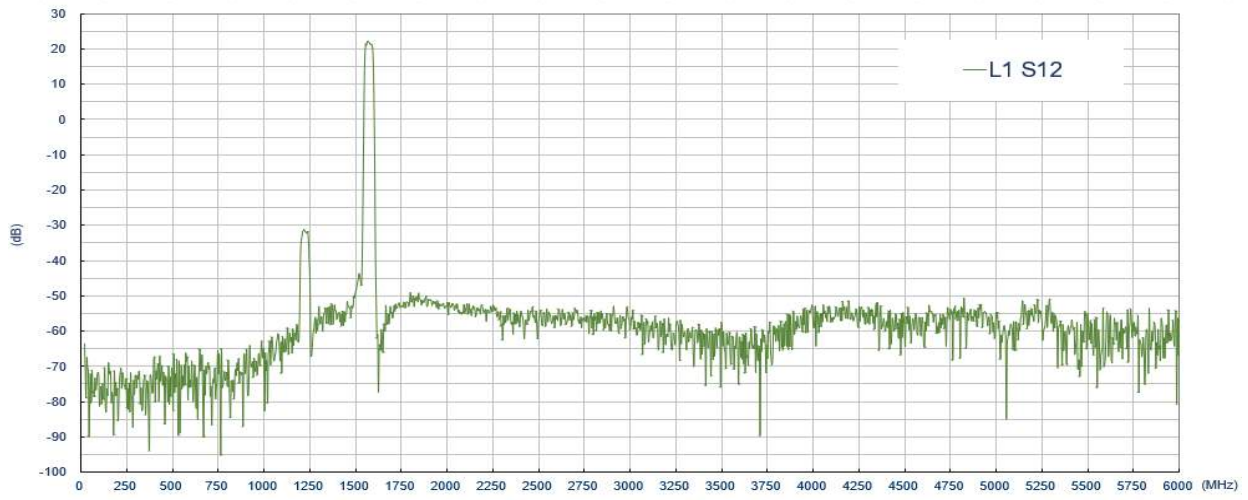

L2 1227MHz

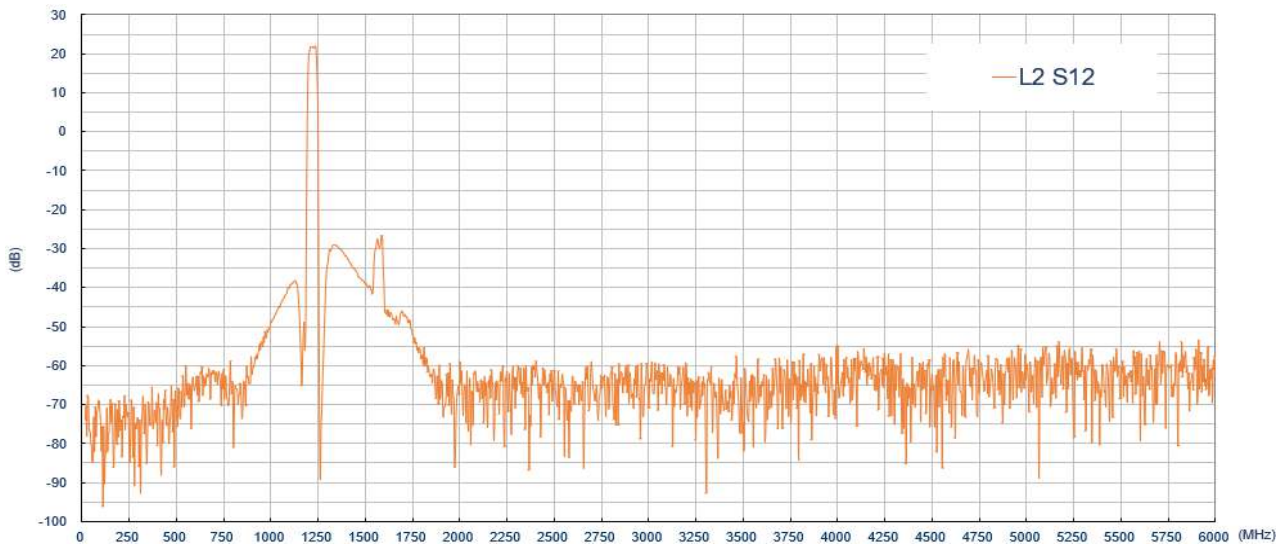

3.10 Noise Figure

L1 1575MHz

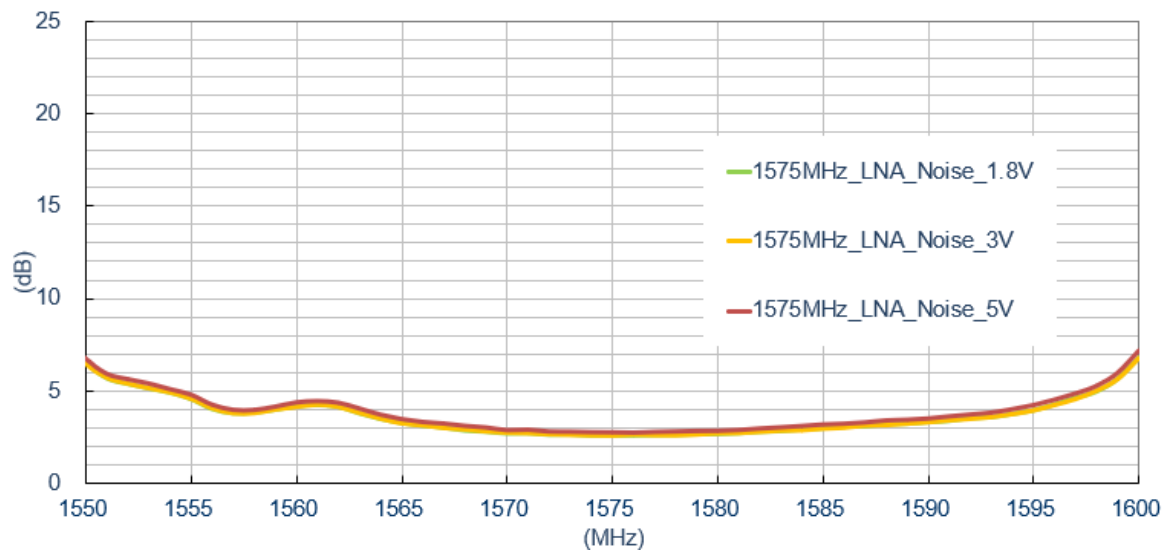

L2 1227MHz

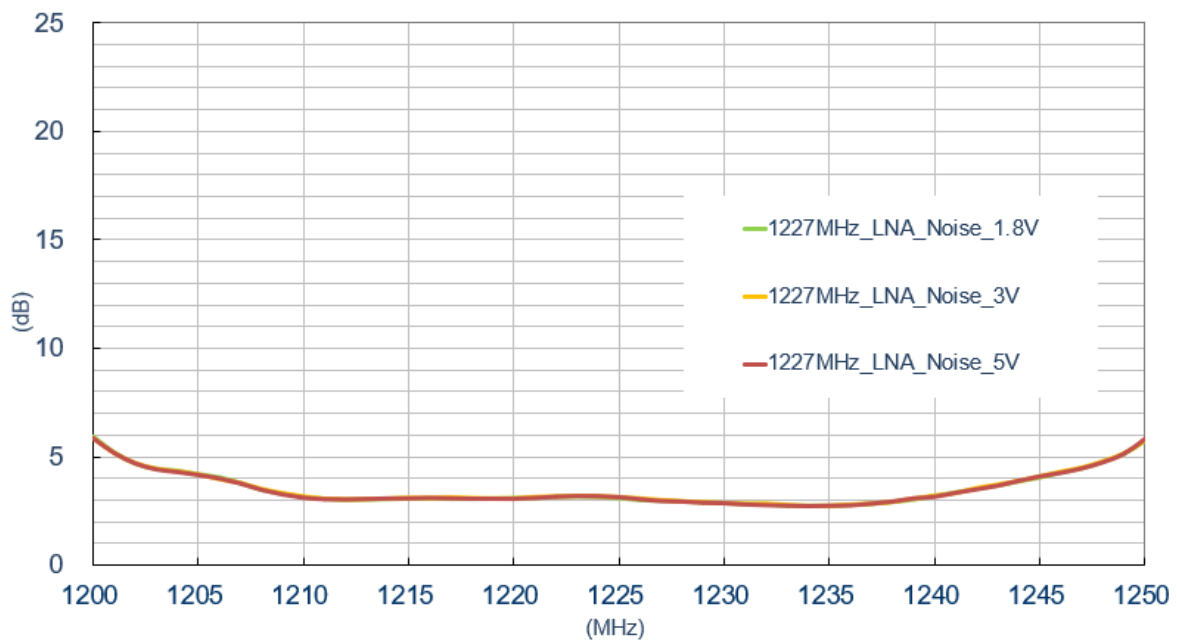

4. Radiation Patterns

4.1 Test Setup

Antenna Radiation Pattern Measurement (Passive Antenna)

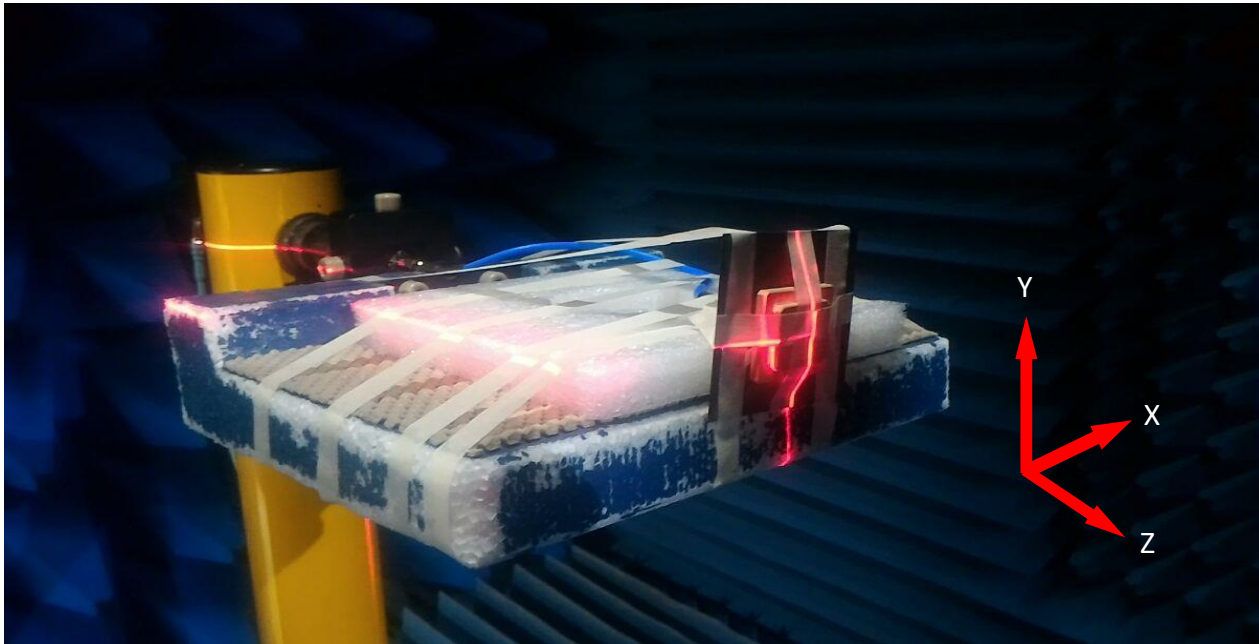

4.2 3D and 2D Radiation Patterns

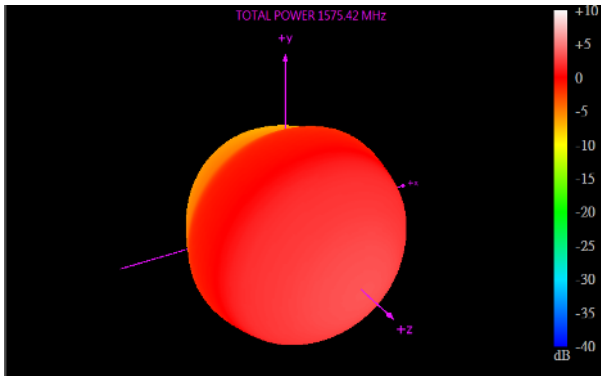

L1 1575.42MHz

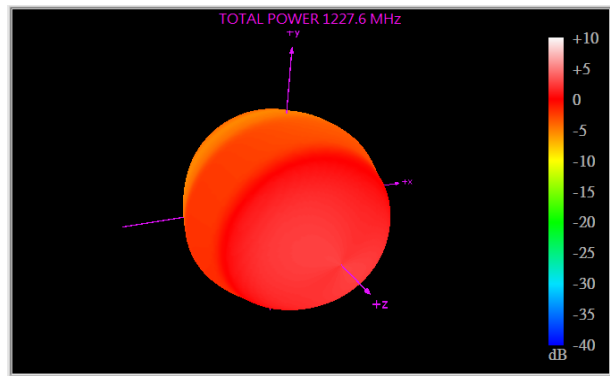

L2 1227.6MHz

XY Plane

XZ Plane

YZ Plane

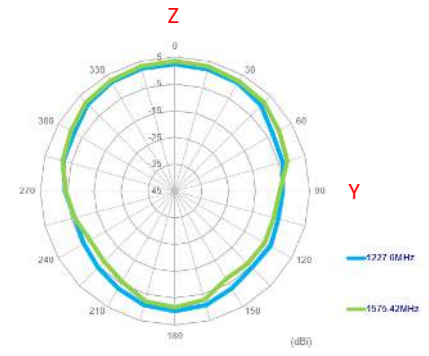
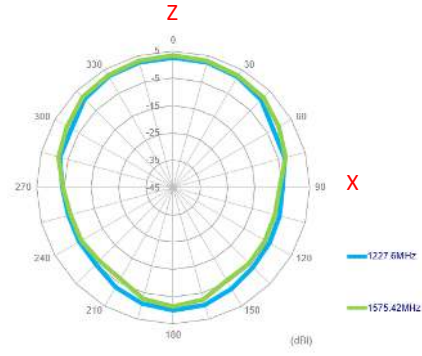
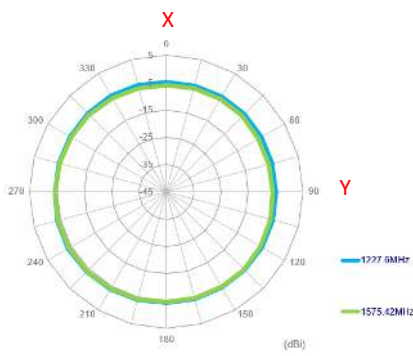

5. Field Test Results

5.1 Rooftop test

In this section Taoglas will present the field test result for AGPSF36C antenna. The test was performed when the antenna was mounted on a static rooftop test set up in an open sky environment for at least **6 hours**.

Taoglas will show the field test results using the following receiver:

1. U-blox ZED-F9P

Receiver features:

- Multi-band GNSS: 184-channel GPS L1C/A L2C, Galileo: E1B/C E5b, QZSS: L1C/A L2C
- Multi-band RTK with fast convergence times and reliable performance
- Nav. update rate RTK up to 20 Hz
- Position accuracy = RTK 0.01 m + 1 ppm CEP

Positioning Accuracy Table (2D Accuracy)					
Test Condition	Correction Service	CEP (50%)	DRMS (68%)	2DRMS (95-98.2%)	TTF (sec)
Free Space	RTK DISABLED	72.19 cm	86.48 cm	172.97 cm	21.4
	RTK ENABLED	1.52 cm	1.87 cm	3.74 cm	21.4

RTK Availability
Free Space

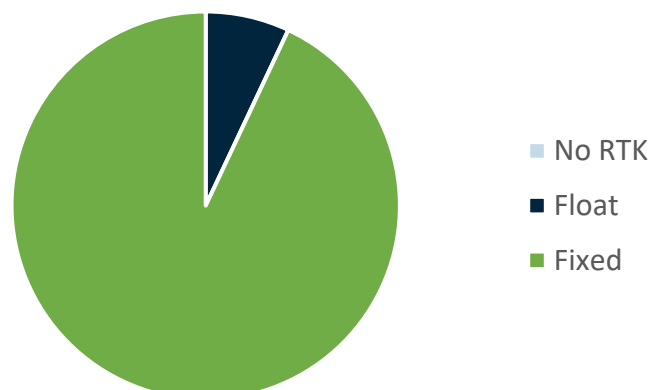

6. Mechanical Drawing (Units: mm)

Front View

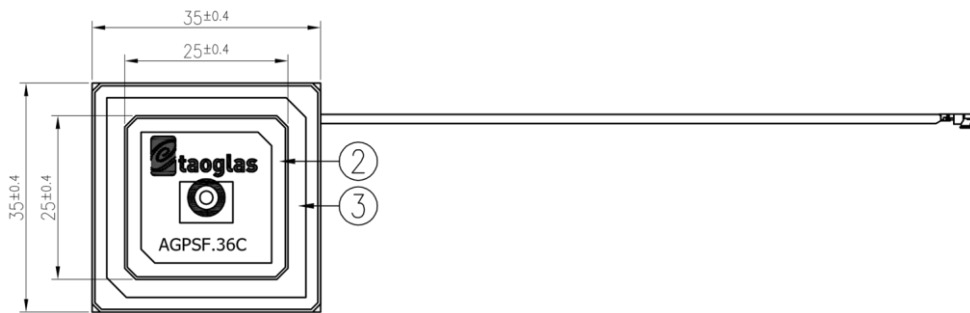

Side View

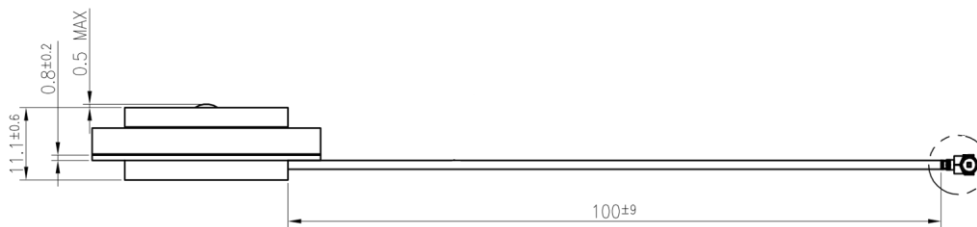

Back View

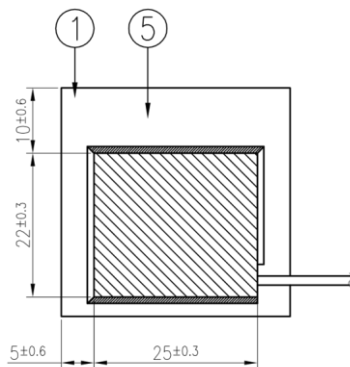

IPEX MHFHT

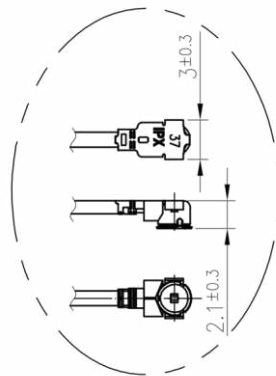

NOTE:

1. Soldered area
2. Shielding case area
3. Soldermask
4. All material must be RoHS compliant.
5. The connector orientation has a fixed position to the antenna as per drawing.

	Name	P/N	Material	Finish	QTY
1	PCB	02110212160120	Composite 0.8t	Black	1
2	Patch(25*25*3)	013A8BAL00001D	Ceramic	Reddish Brown	1
3	Patch(35*35*4)	013A8BAL00001D	Ceramic	Reddish Brown	1
4	IPEX MHFHT	204511G000000A	Brass	Au Plated	1
5	Shielding Case	000518E010000A	SPTe	Sn Plated	1
6	1.37 Coaxial Cable	300515C010000A	FEP	Black	1

7. Packaging

30pc AGPSF.36C.07.0100A per Tray
 Tray Dimensions - 360*300*95mm
 Weight - 3.65Kg

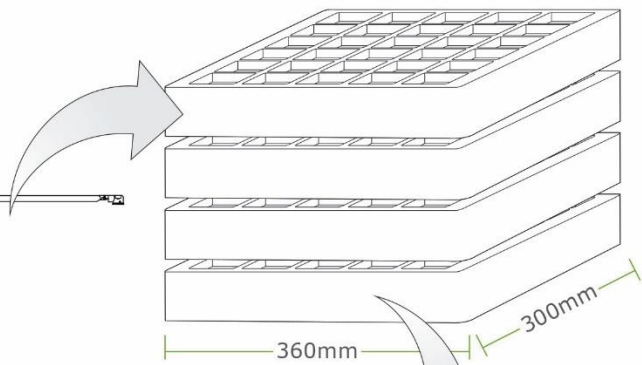

120pc AGPSF.36C.07.0100A per Carton
 Box Dimensions - 390*320*290mm
 Weight - 11.2Kg

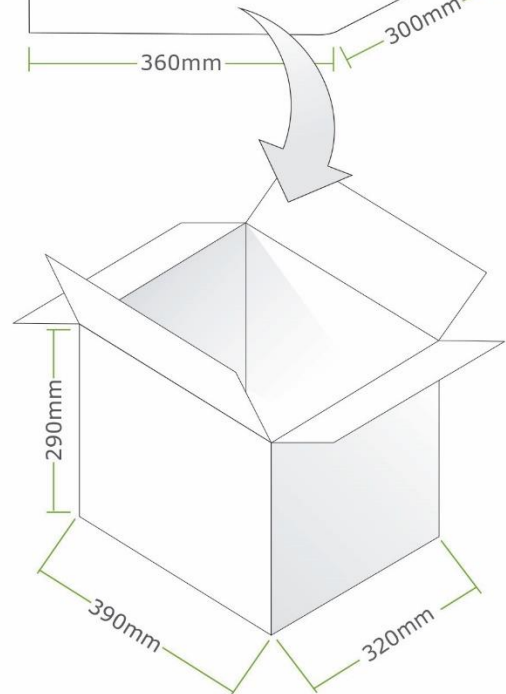

Pallet Dimensions:
 1200mm*1000mm*1360mm
 36 Cartons per Pallet
 9 Cartons per Layer, 4 Layers

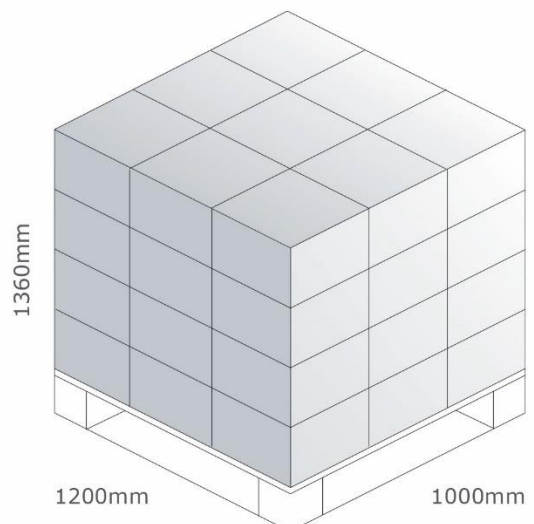

8. Application Note

Using Diplexers with an Active Dual-band Antenna

If your application requires separate L1 and L2 inputs—separate L1 and L2 receiver inputs, for example—then Taoglas diplexers may be used to interface between an active dual-band antenna and these separate inputs. Taoglas offers two GNSS diplexers, the DXP.01.A and DXP.02.A. The DXP.02.A add support for L5 signals (among others). These diplexers offer a unique off-the-shelf option for splitting the GNSS signals with minimal loss while improving out-of-band rejection. See the Taoglas website for further details on these components.



Figure 1 - Taoglas DXP.01.A

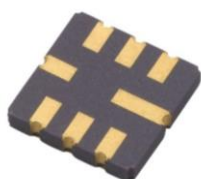

Figure 2 - Taoglas DXP.02.A

Since these components do not pass DC signals, particular attention needs to be paid when using an active antenna. Figure 3 provides a simplified schematic of what is required.

The key features are:

- DC blocks need to be included between the diplexer matching networks and the other subsystems. This helps protect the diplexer and prevent any unintended interactions between the matching network and DC voltages. A typical DC block for GNSS systems is a 22 pF COG ceramic capacitor.
- A separate Bias-T is required on the antenna side of the diplexer. Many receivers include these Bias-T networks internally, but these will be blocked by the diplexer (and DC blocks). A typical RF choke component for GNSS systems is a 39nH wire-wound inductor, though this should be reviewed during design time.



Figure 3 - Schematic

Finally, make sure to following the matching network and layout recommendations for the diplexer in their respective datasheets.

Changelog for the datasheet

SPE-18-8-105 - AGPSF.36C.07.0100C

Revision: H (Current Version)

Date:	2022-02-22
Changes:	Updated GNSS Bands & Constellations Graphics
Changes Made by:	Cesar Sousa

Previous Revisions

Revision: G

Date:	2021-08-01
Changes:	Updated Mechanical Drawing
Changes Made by:	Gary West

Revision: B

Date:	2018-09-28
Changes:	Updated Block Diagram
Changes Made by:	Russell Meyler

Revision: F

Date:	2020-06-02
Changes:	Field test section added
Changes Made by:	Victor Pinazo

Revision: A (Original First Release)

Date:	2018-09-26
Notes:	Initial Release
Author:	Jack Conroy

Revision: E

Date:	2020-03-05
Changes:	Update RTK Data
Changes Made by:	Jack Conroy

Revision: D

Date:	2019-12-08
Changes:	Added GNSS Frequency Bands Matrix and RTK Test Data
Changes Made by:	Yu Kai Yeung

Revision: C (Current Version)

Date:	2018-11-23
Changes:	Updated product from AGPSF.36C.07.0100A to AGPSF.36C.07.0100C version
Changes Made by:	Jack Conroy



TAOGLAS®

www.taoglas.com

