



650 V GaNFast™ Power IC

1. Features

GaNFast™ Power IC

- Thermally-enhanced version of NV6113
- Large cooling pad
- Enhanced thermals when using CS resistor
- Monolithically-integrated gate drive
- Wide V_{CC} range (10 to 30 V)
- Programmable turn-on dV/dt
- 200 V/ns dV/dt immunity
- 800 V Transient Voltage Rating
- 650 V Continuous Voltage Rating
- Low 300 m Ω resistance
- Zero reverse recovery charge
- ESD protection – 2 kV (HBM), 1 kV (CDM)
- 2 MHz operation

Small, low-profile SMT QFN

- 6 x 8 mm footprint, 0.85 mm profile
- Minimized package inductance

Sustainability

- RoHS, Pb-free, REACH-compliant
- Up to 40% energy savings vs Si solutions
- System level 4kg CO₂ Carbon Footprint reduction

Product Reliability

- 20-year limited product warranty (see Section 14 for details)

2. Topologies / Applications

- AC-DC, DC-DC, DC-AC
- QR Flyback, PFC, AHB, Buck, Boost, Half bridge, Full bridge, LLC resonant, Class D
- Wireless power, Solar Micro-inverters, LED lighting, TV SMPS, Server, Telecom

4. Typical Application Circuits

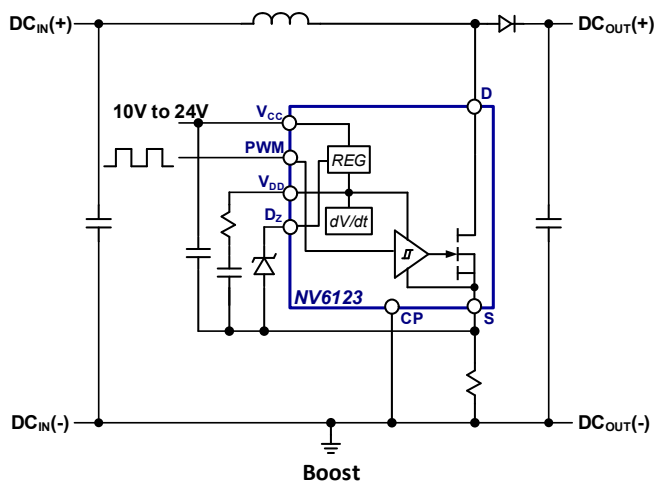

QFN 6 x 8 mm

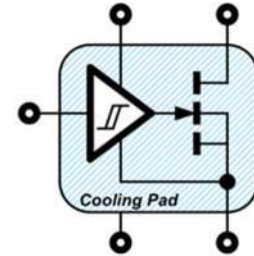

Simplified schematic

3. Description

The NV6123 is a thermally-enhanced version of the popular NV6113 650 V GaNFast™ power IC, optimized for high-frequency and soft-switching topologies.

Monolithic integration of FET, drive and logic creates an easy-to-use ‘digital in, power out’ high performance powertrain building block, enabling designers to create the fastest, smallest, most efficient integrated powertrain in the world.

The highest dV/dt immunity, high-speed integrated drive and industry standard low-profile, low-inductance, 6 x 8 mm SMT QFN package allow designers to exploit Navitas GaN technology with simple, quick, dependable solutions for breakthrough power density and efficiency.

Navitas’ GaNFast™ power ICs extend the capabilities of traditional topologies such as flyback, half-bridge, resonant, etc. to MHz+ and enable the commercial introduction of breakthrough designs.

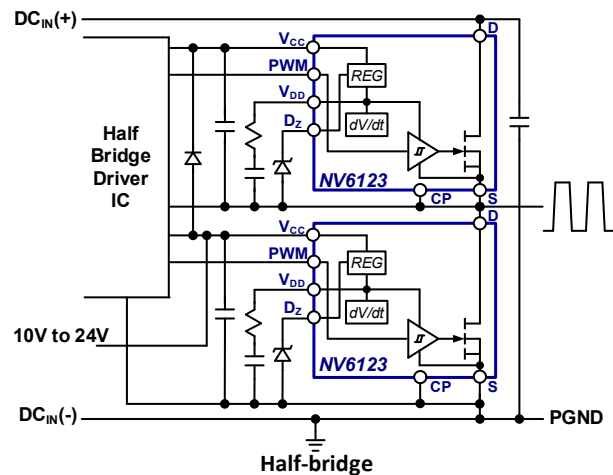

5. Table of Contents

1. Features	1	8.4. Programmable Turn-on dV/dt Control.....	12
2. Description	1	8.5. Current Sensing	13
3. Topologies / Applications	1	8.6. Paralleling Devices.....	13
4. Typical Application Circuits	1	8.7. 3.3V PWM Input Circuit.....	14
5. Table of Contents	2	8.8. PCB Layout Guidelines.....	14
6. Specifications	3	8.9. Recommended Component Values	15
6.1. Absolute Maximum Ratings ⁽¹⁾	3	8.9.1. Zener Selection	15
6.2. Recommended Operating Conditions ⁽³⁾	3	8.10. Drain-to-Source Voltage Considerations	16
6.3. ESD Ratings.....	4	9. Recommended PCB Land Pattern	17
6.4. Thermal Resistance	4	10. PCB Layout Guidelines	18
6.5. Electrical Characteristics.....	5	11. QFN Package Outline	20
6.6. Switching Waveforms	6	12. Tape and Reel Dimensions	21
6.7. Characteristic Graphs	7	13. Ordering Information	23
7. Internal Schematic, Pin Configurations and Functions	10	14. 20-Year Limited Warranty	23
8. Functional Description	11	15. Revision History	23
8.1. Start Up	11		
8.2. Normal Operating Mode.....	12		
8.3. Standby Mode.....	12		

6. Specifications

6.1. Absolute Maximum Ratings⁽¹⁾

(with respect to Source (pad) unless noted)

SYMBOL	PARAMETER	MAX	UNITS
V_{TDS}	Transient Drain-to-Source Voltage ⁽²⁾	800	V
V_{DS}	Drain-to-Source Voltage	-7 to +650	V
V_{CC}	Supply Voltage	30	V
V_{PWM}	PWM Input Pin Voltage	-3 to +30	V
V_{DZ}	V_{DD} Setting Pin Voltage	6.6	V
V_{DD}	Drive Supply Voltage	7.2	V
V_{CP}	Cooling Pad Voltage	-10 to +10	V
I_D	Continuous Drain Current (@ $T_C = 100^\circ\text{C}$)	5	A
I_D PULSE	Pulsed Drain Current (10 μs @ $T_J = 25^\circ\text{C}$)	10	A
I_D PULSE	Pulsed Drain Current (10 μs @ $T_J = 125^\circ\text{C}$)	7.5	A
dV/dt	Slew Rate on Drain-to-Source	200	V/ns
T_J	Operating Junction Temperature	-55 to 150	$^\circ\text{C}$
T_{STOR}	Storage Temperature	-55 to 150	$^\circ\text{C}$

(1) Absolute maximum ratings are stress ratings; devices subjected to stresses beyond these ratings may cause permanent damage.

(2) $V_{DS(TRAN)}$ allows for surge ratings during non-repetitive events that are <100 μs (for example start-up, line interruption) and repetitive events that are <100ns (for example repetitive leakage inductance spikes). Refer to Section 8.10 for detailed recommended design guidelines.

6.2. Recommended Operating Conditions⁽³⁾

SYMBOL	PARAMETER	MIN	TYP	MAX	UNITS
V_{DZ}	Drive Supply Set Zener Voltage ⁽⁴⁾	5.8	6.2	6.6	V
V_{DD}	Drive Supply Voltage	5.5		7.0	V
I_{DD_EXT}	Regulator External Load Current			3.0	mA
R_{DD}	Gate Drive Turn-On Current Set Resistance ⁽⁵⁾	10	25	200	Ω
V_{PWM}	PWM Input Pin Voltage	0	5	Min. of (V_{CC} or 20)	V
V_{CC}	Supply Voltage	10		24	V
T_C	Operating Case Temperature	-40		125	$^\circ\text{C}$

(3) Exposure to conditions beyond maximum recommended operating conditions for extended periods of time may affect device reliability.

(4) Use of Zener diode other than 6.2 V is not recommended. See for recommended part numbers of 6.2 V Zener diodes.

(5) R_{DD} resistor must be used. Minimum 10 Ohm to ensure application and device robustness.

6.3. ESD Ratings

SYMBOL	PARAMETER	MAX	UNITS
HBM	Human Body Model (per JS-001-2014)	2,000	V
CDM	Charged Device Model (per JS-002-2014)	1,000	V

6.4. Thermal Resistance

SYMBOL	PARAMETER	TYP	UNITS
$R_{\theta JC}^{(6)}$	Junction-to-Case	2.2	°C/W
$R_{\theta JA}^{(6)}$	Junction-to-Ambient	40	°C/W

(6) R_{θ} measured on DUT mounted on 1 square inch 2 oz Cu (FR4 PCB)

6.5. Electrical Characteristics

Typical conditions: $V_{DS} = 400\text{ V}$, $V_{CC} = 15\text{ V}$, $V_{DZ} = 6.2\text{ V}$, $F_{SW} = 1\text{ MHz}$, $T_{AMB} = 25\text{ °C}$, $I_D = 2.5\text{ A}$, $R_{DD} = 10\text{ }\Omega$ (or specified)

SYMBOL	PARAMETER	MIN	TYP	MAX	UNITS	CONDITIONS
V_{CC} Supply Characteristics						
I_{QCC}	V_{CC} Quiescent Current		0.9	1.5	mA	$V_{PWM} = 0\text{ V}$
I_{QCC-SW}	V_{CC} Operating Current		1.5		mA	$F_{SW} = 1\text{ MHz}$, $V_{DS} = \text{Open}$
Low-Side Logic Input Characteristics						
V_{PVMH}	Input Logic High Threshold (rising edge)			4	V	
V_{PVML}	Input Logic Low Threshold (falling edge)	1			V	
V_{L-HYS}	Input Logic Hysteresis		0.5		V	
T_{ON}	Turn-on Propagation Delay		11		ns	Fig.1, Fig.2
T_{OFF}	Turn-off Propagation Delay		9		ns	Fig.1, Fig.2
T_R	Drain rise time		6		ns	Fig.1, Fig.2
T_F	Drain fall time		3		ns	Fig.1, Fig.2
Switching Characteristics						
F_{SW}	Switching Frequency			2	MHz	
t_{PW}	Pulse width	0.02		1000	μs	
GaN FET Characteristics						
I_{DSS}	Drain-Source Leakage Current		0.1	25	μA	$V_{DS} = 650\text{ V}$, $V_{PVM} = 0\text{ V}$
I_{DSS}	Drain-Source Leakage Current		3	50	μA	$V_{DS} = 650\text{ V}$, $V_{PVM} = 0\text{ V}$, $T_C = 125\text{ °C}$
$R_{DS(ON)}$	Drain-Source Resistance		300	430	m Ω	$V_{PVM} = 6\text{ V}$, $I_D = 2.5\text{ A}$
$R_{DS(ON)}$	Drain-Source Resistance		621		m Ω	$V_{PVM} = 6\text{ V}$, $I_D = 2.5\text{ A}$, $T_C = 125\text{ °C}$
V_{SD}	Source-Drain Reverse Voltage		3.2	5	V	$V_{PVM} = 0\text{ V}$, $I_{SD} = 2.5\text{ A}$
Q_{OSS}	Output Charge		10		nC	$V_{DS} = 400\text{ V}$, $V_{PVM} = 0\text{ V}$
Q_{RR}	Reverse Recovery Charge		0		nC	
C_{OSS}	Output Capacitance		12		pF	$V_{DS} = 400\text{ V}$, $V_{PVM} = 0\text{ V}$
$C_{O(er)}^{(7)}$	Effective Output Capacitance, Energy Related		16		pF	$V_{DS} = 400\text{ V}$, $V_{PVM} = 0\text{ V}$
$C_{O(tr)}^{(8)}$	Effective Output Capacitance, Time Related		25		pF	$V_{DS} = 400\text{ V}$, $V_{PVM} = 0\text{ V}$

(7) $C_{O(er)}$ is a fixed capacitance that gives the same stored energy as C_{OSS} while V_{DS} is rising from 0 to 400 V

(8) $C_{O(tr)}$ is a fixed capacitance that gives the same charging time as C_{OSS} while V_{DS} is rising from 0 to 400 V

6.6. Switching Waveforms

($T_c = 25\text{ }^\circ\text{C}$ unless otherwise specified)

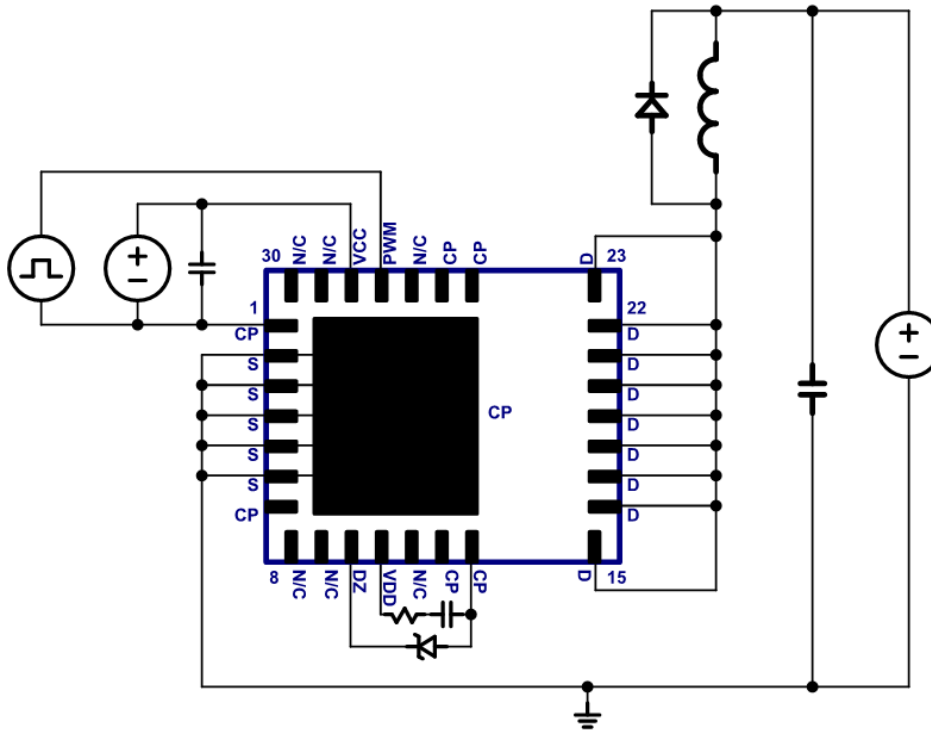

Fig. 1. Inductive switching circuit

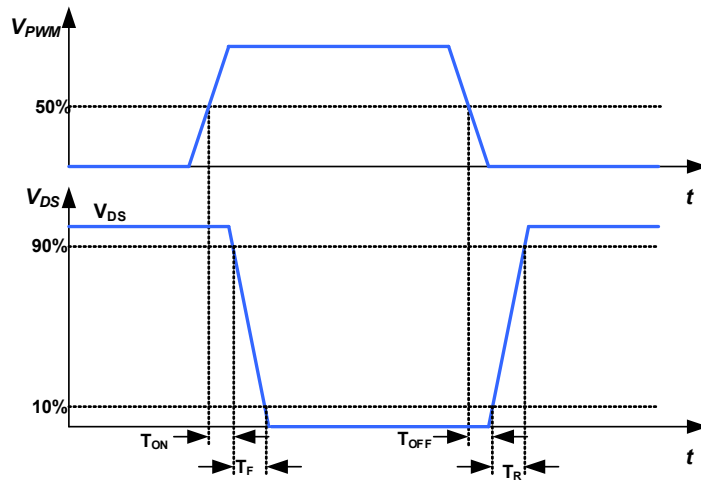

Fig. 2. Propagation delay and rise/fall time definitions

6.7. Characteristic Graphs

(GaN FET, $T_C = 25\text{ }^\circ\text{C}$ unless otherwise specified)

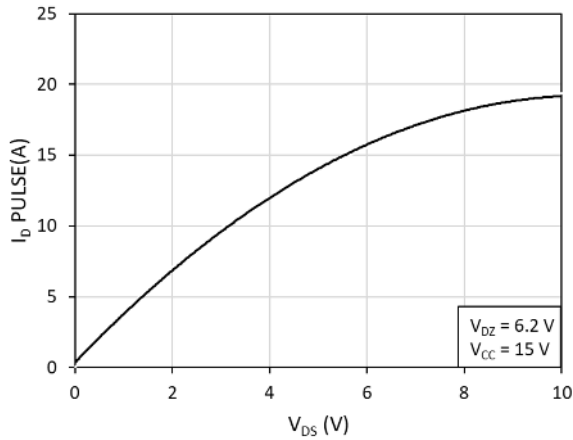

Fig. 3. Pulsed Drain current (I_D PULSE) vs. drain-to-source voltage (V_{DS}) at $T = 25\text{ }^\circ\text{C}$

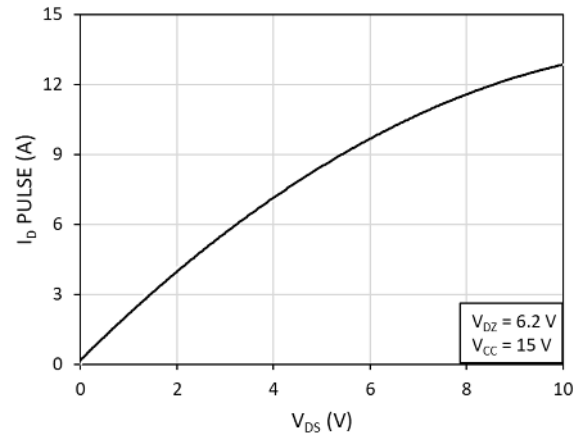

Fig. 4. Pulsed Drain current (I_D PULSE) vs. drain-to-source voltage (V_{DS}) at $T = 125\text{ }^\circ\text{C}$

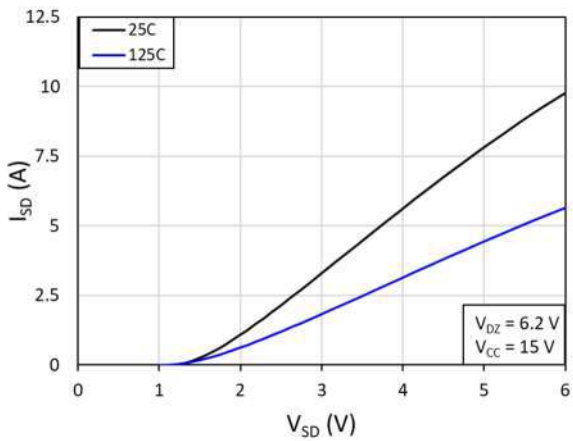

Fig. 5. Source-to-drain reverse conduction voltage

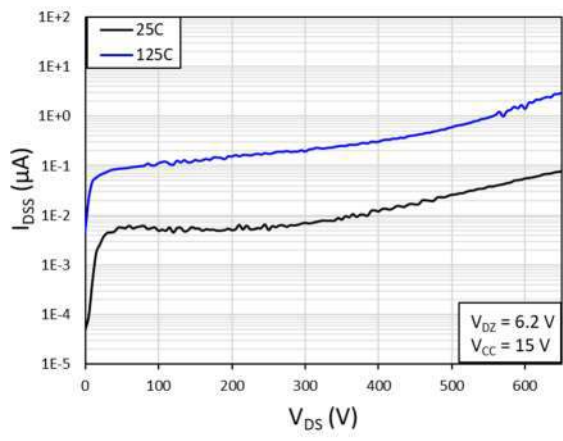

Fig. 6. Drain-to-source leakage current (I_{DSS}) vs. drain-to-source voltage (V_{DS})

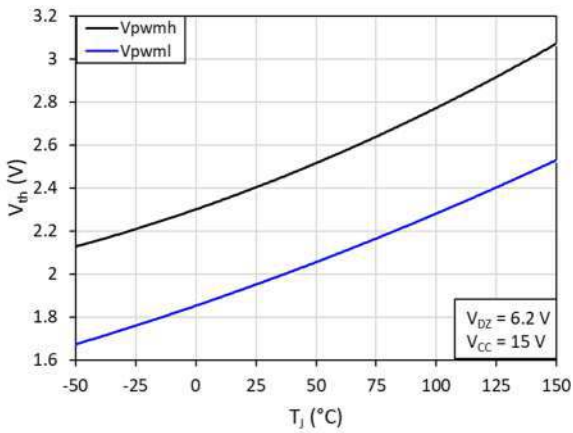

Fig. 7. V_{PWMH} and V_{PWMML} vs. junction temperature (T_J)

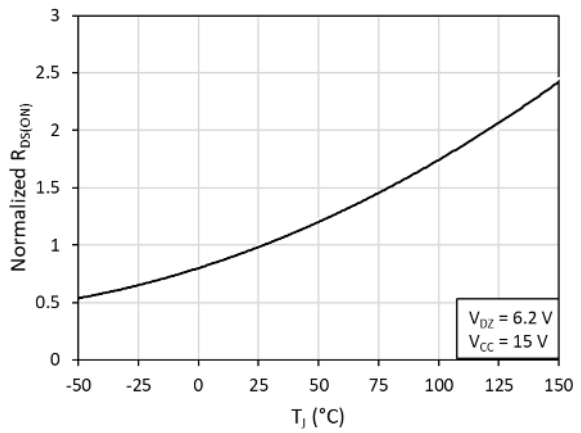

Fig. 8. Normalized on-resistance ($R_{DS(ON)}$) vs. junction temperature (T_J)

Characteristic Graphs (Cont.)

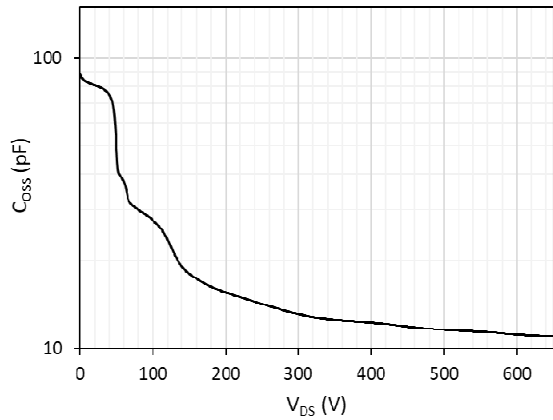

Fig. 9. Output capacitance (C_{OSS}) vs. drain-to-source voltage (V_{DS})

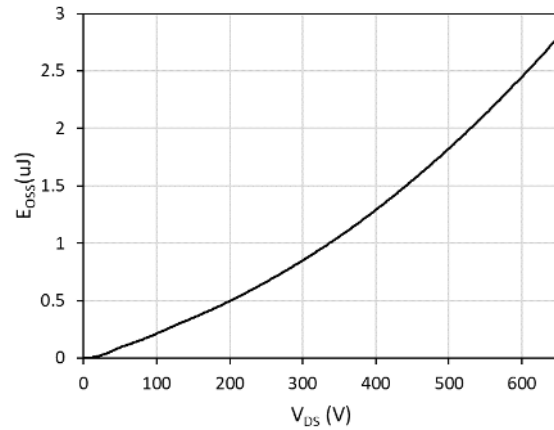

Fig. 10. Energy stored in output capacitance (E_{OSS}) vs. drain-to-source voltage (V_{DS})

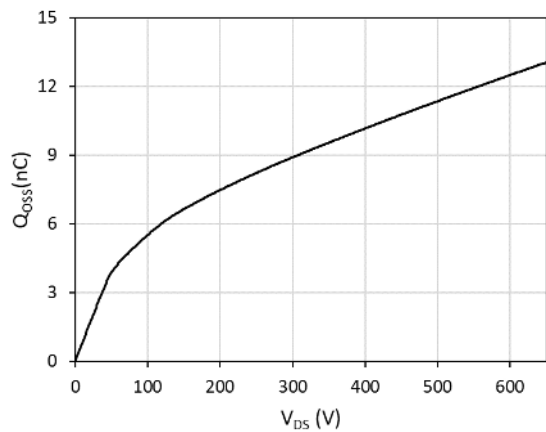

Fig. 11. Charge stored in output capacitance (Q_{OSS}) vs. drain-to-source voltage (V_{DS})

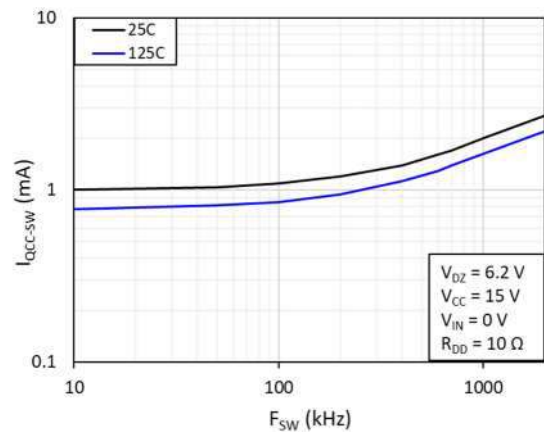

Fig. 12. V_{CC} operating current (I_{QCC-SW}) vs. operating frequency (F_{SW})

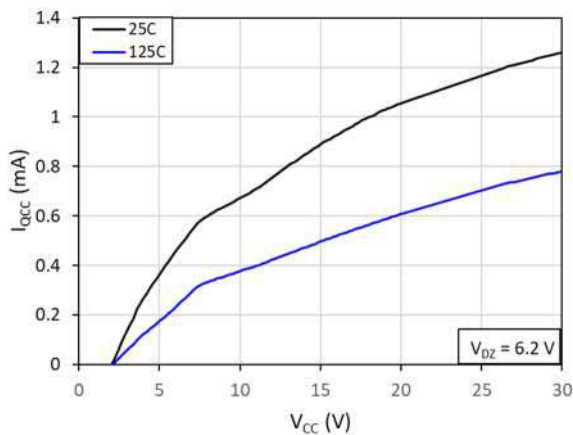

Fig. 13. V_{CC} quiescent current (I_{QCC}) vs. supply voltage (V_{CC})

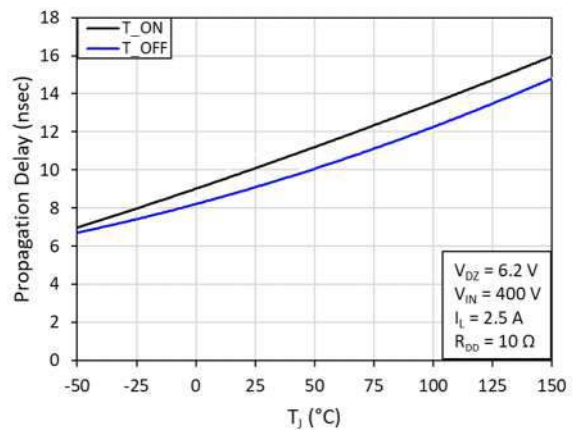

Fig. 14. Propagation delay (T_{ON} and T_{OFF}) vs. junction temperature (T_J)

Characteristic Graphs (Cont.)

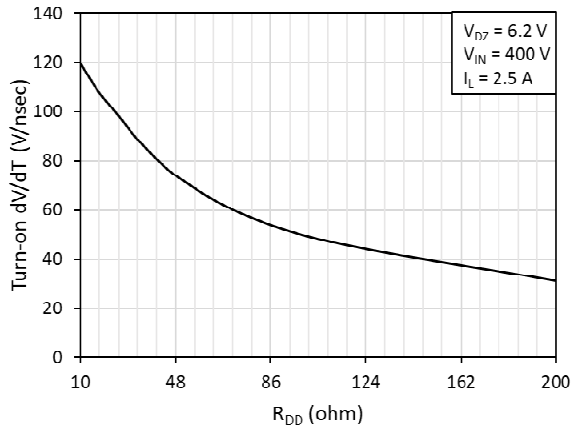

Fig. 15. Slew rate (dV/dt) vs. gate drive turn-on current set resistance (R_{DD}) at $T = 25\text{ }^{\circ}\text{C}$

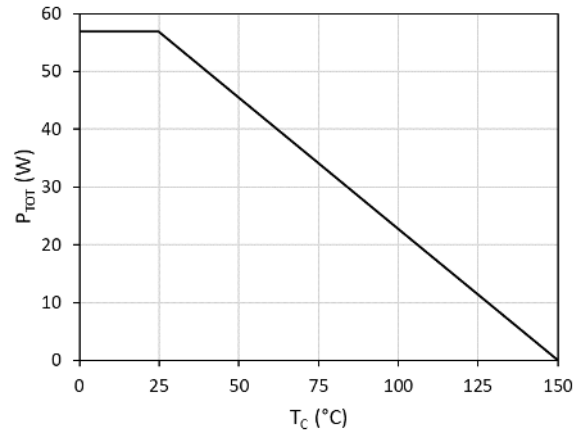

Fig. 16. Power dissipation (P_{TOT}) vs. case temperature (T_C)

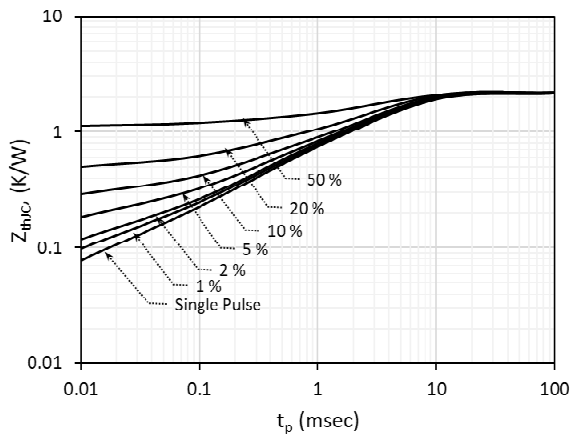
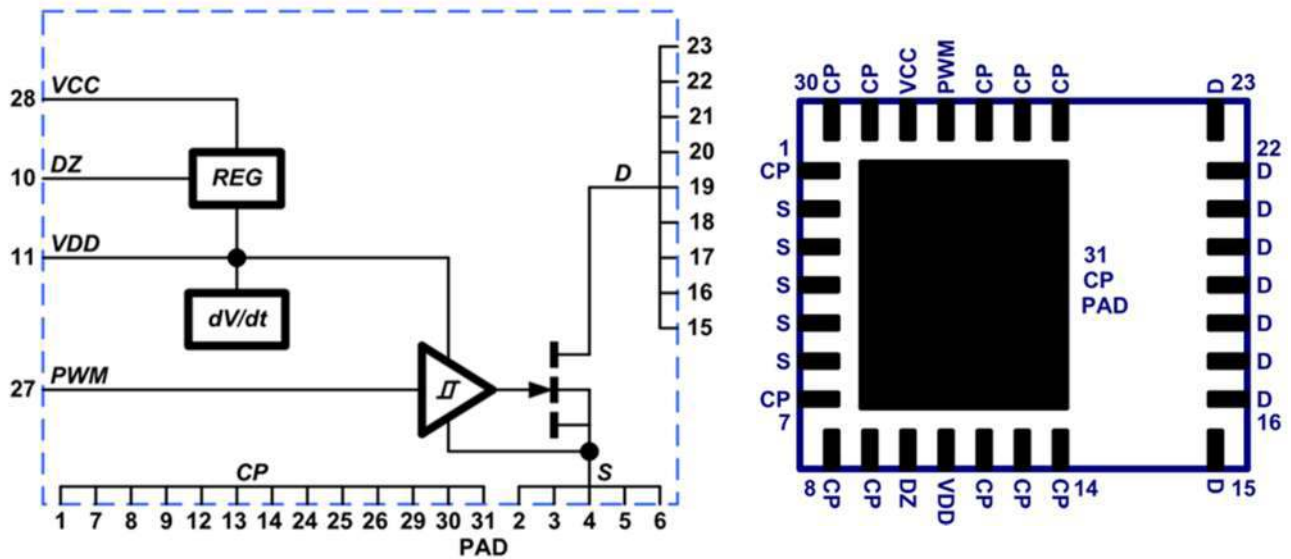

Fig. 17. Max. thermal transient impedance (Z_{thJC}) vs. pulse width (t_p)

7. Internal Schematic, Pin Configurations and Functions



Package Top View

Pin		I/O ⁽¹⁾	Description
Number	Symbol		
1,7,8,9,12,13,14,24,25,26,29,30,31	CP	T	Metal cooling pad on bottom of package for thermal management. CP must be connected to Source or circuit PGND. Do not leave CP unconnected or floating!
2,3,4,5,6	S	O, G	Source of power FET & GaN IC supply ground.
10	D _Z	I	Gate drive supply voltage set pin (6.2 V Zener to GND).
11	V _{DD}	I	Gate drive supply voltage. Gate drive turn-on current set pin (using R _{DD}).
27	PWM	I	PWM input
28	V _{CC}	P	Supply voltage (10V to 24V)
15,16,17,18,19,20,21,22,23	D	P	Drain of power FET

(1) I = Input, O = Output, P = Power, G = GaN IC Ground, T = Thermal

8. Functional Description

The following functional description contains additional information regarding the IC operating modes and pin functionality.

8.1. Start Up

When the V_{CC} supply is first applied, care should be taken such that the V_{DD} and D_Z pins are up at their correct voltage levels before the PWM input signal starts. The V_{DD} pin ramp up time is determined by the internal regulator current at this pin and the external C_{VDD} capacitor. Also, since the D_Z pin voltage sets the V_{DD} voltage level, the V_{DD} pin will ramp up together with the D_Z pin (Fig. 18).

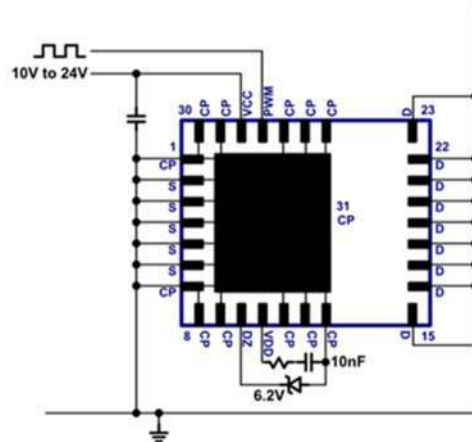

Fig. 18. Start-up circuit

For half-bridge configurations, it is important that the V_{CC} supply, the D_Z pin, and the V_{DD} supply of the high-side GaNFast power IC are all charged up to their proper levels before the first high-side PWM pulses start. For LLC applications, a long on-time PWM pulse to the low-side ($> 10 \mu s$) is typically provided by the LLC controller to allow the supply pins of the high-side device to charge up (through the external bootstrap diode) to their correct levels before the first high-side PWM pulses start (Fig. 19).

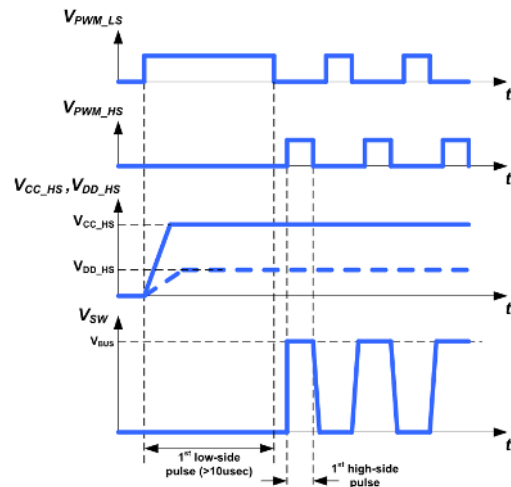

Fig. 19. LLC half-bridge start-up timing diagram

For active clamp flyback (ACF) applications, the half-bridge must be ready very quickly due to the soft-start mode of the ACF controller. When the first few PWM pulses are generated by the ACF controller, the high-side supply pins of the power IC will require a few low-side pulses to charge up (through the external bootstrap diode) before the high-side starts to switch (Fig. 20).

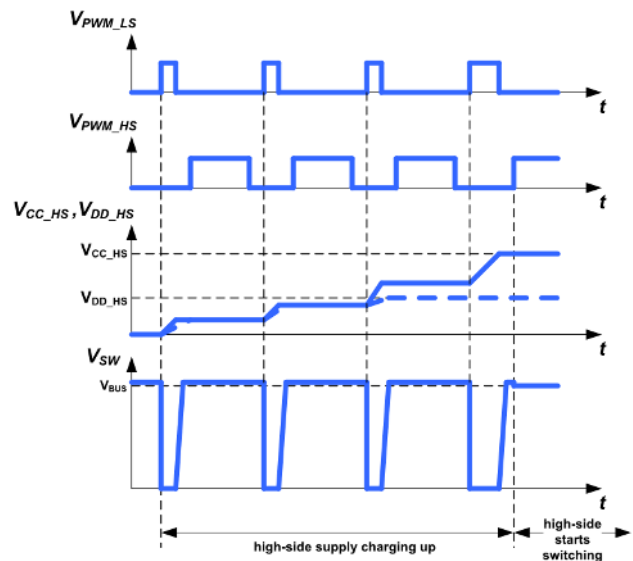

Fig. 20. ACF half-bridge start-up timing diagram

8.2. Normal Operating Mode

During Normal Operating Mode, all of the internal circuit blocks are active. V_{CC} is operating within the recommended range of 10 V to 24 V, the V_{DD} pin is at the voltage set by the Zener diode at the D_Z pin (6.2 V), and the internal gate drive and power FET are both enabled. The external PWM signal at the PWM pin determines the frequency and duty-cycle of the internal gate of the power FET. As the PWM voltage toggles above and below the rising and falling input thresholds (4 V and 1 V), the internal gate of the power FET toggles on and off between V_{DD} and 0 V (Fig. 21). The drain of the power FET then toggles between the source voltage (typically power ground) and a higher voltage level (650 V max), depending on the external power conversion circuit topology.

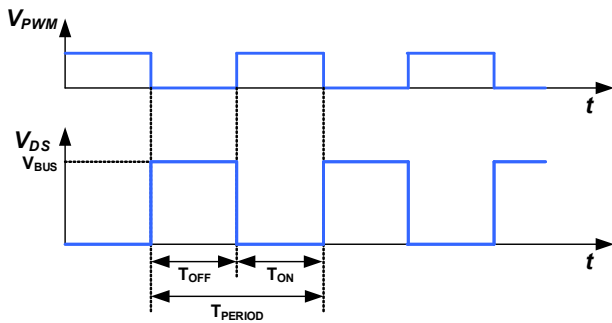

Fig. 21. Normal operating mode timing diagram

8.3. Standby Mode

For applications where a low standby power is required, an external series cut-off circuit (Fig. 22) can be used to disconnect V_{CC} of the GaNFast power IC from the main V_{CC} supply of the power supply. This will reduce V_{CC} current consumption when the converter is in burst mode during light-load or open load conditions. The V_{CC} cut-off circuit consists of a series PMOS FET that is turned on and off with a pull-down NMOS FET. The gate of the NMOS is controlled by an external ENABLE signal that should be provided by the main controller of the power supply. The capacitor value at the V_{CC} pin should then be selected according to the desired start-up speed, each time the ENABLE signal toggles high. A 22 nF capacitor at V_{CC} , for example, will give a typical start-up time of approximately 2 μ s. An additional 200 k Ω resistor is placed across the PMOS cut-off FET to provide a small V_{CC} voltage level for proper start-up.

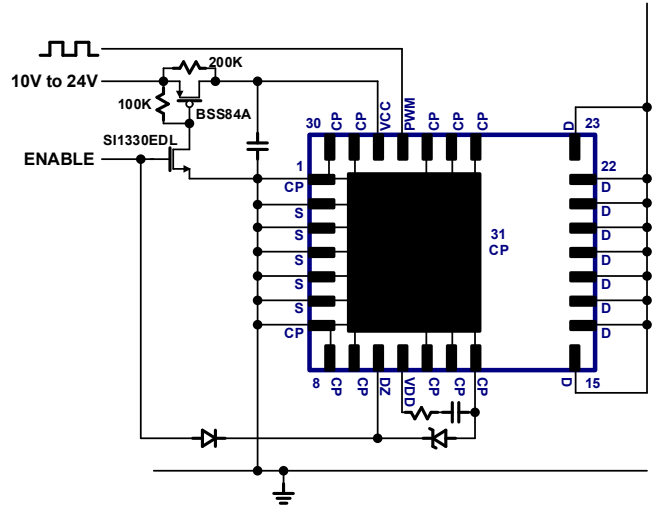

Fig. 22. Standby mode V_{CC} cut-off circuit

8.4. Programmable Turn-on dV/dt Control

During first start-up pulses or during hard-switching conditions, it is desirable to limit the slew rate (dV/dt) of the drain of the power FET during turn-on. This is necessary to reduce EMI or reduce circuit switching noise. To program the turn-on dV/dt rate of the internal power FET, a resistor (R_{DD}) is placed in between the V_{DD} capacitor and the V_{DD} pin. This resistor (R_{DD}) sets the turn-on current of the internal gate driver and therefore sets the turn-on falling edge dV/dt rate of the drain of the power FET (Fig. 23). A typical turn-on slew-rate change with respect to R_{DD} is shown in Fig. 15.

Minimum 10 Ω R_{DD} is required.

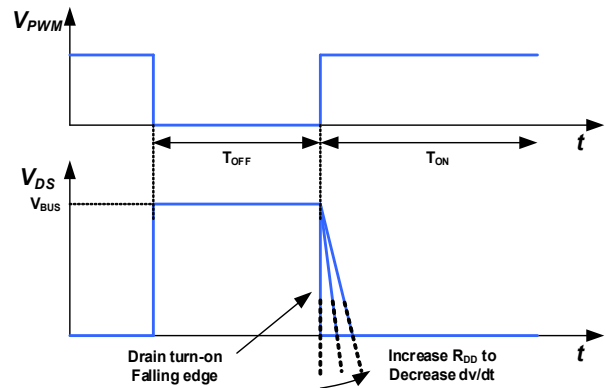

Fig. 23. Turn-on dV/dt slew rate control

8.5. Current Sensing

For many applications it is necessary to sense the cycle-by-cycle current flowing through the power FET. To sense the current flowing through the GaNFast power IC, a standard current-sensing resistor can be placed between the source and power ground (Fig. 24). In this configuration, all of the components around the GaNFast power IC (V_{CC} , V_{DD} , D_z , etc.) should be grounded with a single connection at the source. Also, an additional RC filter can be inserted between the PWM signal and the PWM pin (100 Ω , 100 pF typical). This filter is necessary to prevent false triggering due to high-frequency voltage spikes occurring at the source node due to external parasitic inductance from the source PCB trace or the current-sensing resistor itself. For increased cooling pad PCB copper area it may be desired to connect CP to the circuit PGND. Fig. 24 shows the components around the GaNFast power IC grounded at the source pins (S and CP connected to PGND). This allows for all CP pins and CP pad to be connected to a large and continuous thermal copper area without being obstructed by the current sensing resistor. CP must be connected to source (S) or circuit PGND! Do not leave CP floating!

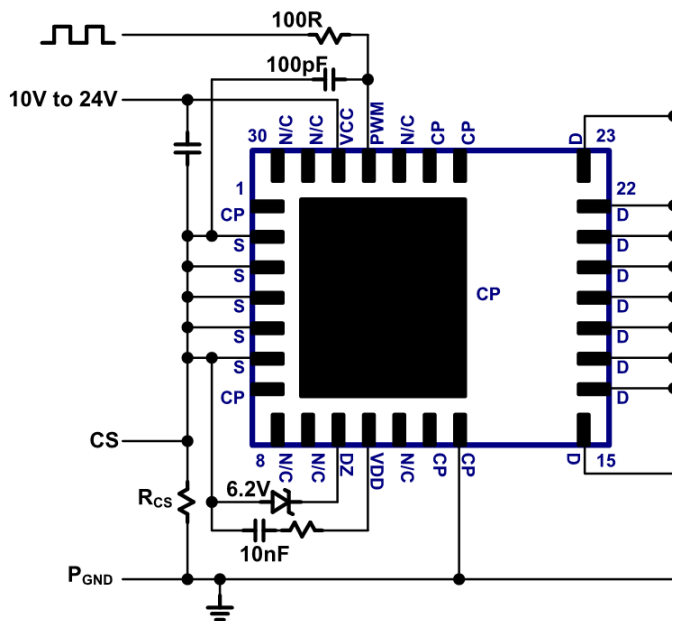

Fig. 24. Current sensing circuit

8.6. Paralleling Devices

For some applications it is desirable to parallel ICs in order to reduce conduction losses and temperatures. Two GaNFast power ICs can be connected in parallel in a PFC boost application working in boundary-conduction mode (BCM) only. This configuration is shown in Fig. 25. The paired pins that are connected together include the drain pins (D), the source pins (S), the V_{CC} pins, the PWM pins, and the D_z . A single D_z diode can be shared by both ICs. The V_{DD} pins are not connected together and require separate V_{DD} supply capacitors (C_{VDD1} , C_{VDD2}) and separate turn-on current set resistors (R_{DD1} , R_{DD2}). Each IC should have its own local V_{CC} supply filter capacitor (C_{VCC1} , C_{VCC2}). The PWM pins can have a single filter resistor (R_{PWM}) but separate filter capacitors (C_{PWM1} , C_{PWM2}) should be placed at the PWM pin of each IC. When designing the PCB layout for the two paralleled ICs, the drain and source connections should be made as symmetrical as possible two avoid any parasitic inductance or capacitance mismatch.

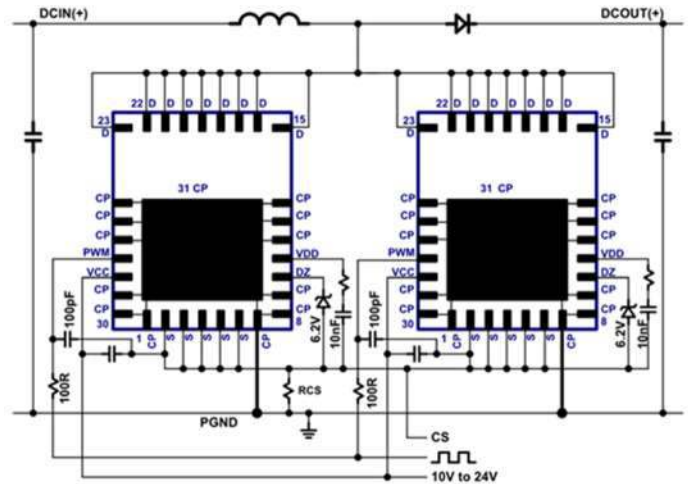

Fig. 25. Boost schematic using two parallel ICs

8.7. 3.3V PWM Input Circuit

For some applications where a 3.3 V PWM signal is required (DSP, MCU, etc.) an additional buffer can be placed before the PWM input pin (Fig. 26) with the buffer supply voltage connected to the V_{DD} capacitor.

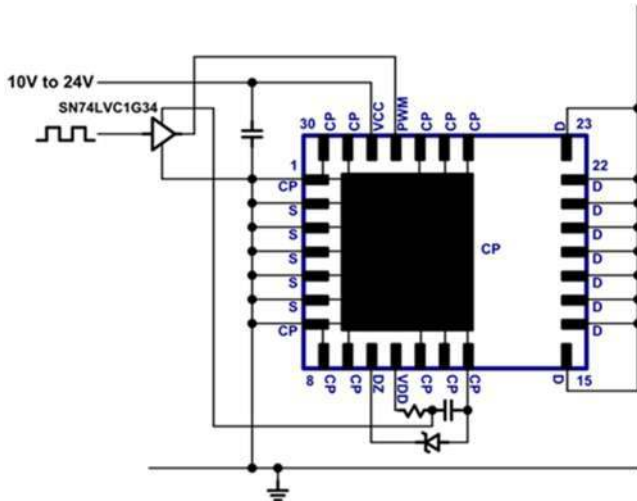

Fig. 26. 3.3 V PWM input buffer circuit

8.8. PCB Layout Guidelines

The design of the PCB layout is critical for good noise immunity, sufficient thermal management, and proper operation of the IC. Typical PCB layout examples for without current sensing resistor and with current sensing resistor are shown in Section 0.

The following rules should be followed carefully during the design of the PCB layout:

- 1) Place all IC filter and programming components directly next to the IC. These components include (C_{VCC} , C_{VDD} , R_{PWM} , C_{PWM} , R_{DD} and D_z).
- 2) Keep ground trace of IC filter and programming components separate from power GND trace. Do not run power GND currents through ground trace of filter components!
- 3) For best thermal management, place thermal vias in the source pad area to conduct the heat out through the bottom of the package and through the PCB board to other layers (see Section 10 for correct layout examples).
- 4) Use large PCB thermal planes (connected with thermal vias to the source pad) and additional PCB layers to reduce IC temperatures as much as possible (see Section 0 for correct layout examples).
- 5) For half-bridge layouts, do not extend copper planes from one IC across the components or pads of the other IC!
- 6) For high density designs, use a 4-layer PCB and 2 oz. copper to route signal connections. This allows layout to maintain large thermal copper planes and reduce power device temperature.

8.9. Recommended Component Values

The following table () shows the recommended component values for the external filter capacitors, Zener diode, and R_{DD} connected to the pins of this GaNFast power IC. These components should be placed as close as possible to the IC. Please see PCB Layout guidelines for more information. The Zener diode at the D_z pin should be a low-current type with a flat Zener, and the min/max limits must be followed. R_{DD} must be a minimum of 10 Ω to ensure application and device robustness.

SYM	DESCRIPTION	MIN	TYP	MAX	UNITS
C_{VCC}	Maximum V_{CC} supply capacitor		0.1		μF
C_{VDD}	V_{DD} supply capacitor		0.01		μF
R_{DD}	Gate drive turn-on current set resistor	10	25	200	Ω
R_{PWM}	PWM filter resistor		100		Ω
C_{PWM}	PWM filter capacitor		100		pF

Table I. Recommended component values.

8.9.1. Zener Diode Selection

The Zener voltage is a critical parameter that sets the internal reference for gate drive voltage and other circuitry. The Zener diode needs to be selected such that the voltage on the D_z pin is within recommended operating conditions (5.8 V to 6.6 V) across operating temperature (-40°C to 125°C) and bias current (10 μA to 1 mA). To ensure effective operation, the current vs. voltage characteristics of the Zener diode should be measured down to 10 μA to ensure flat characteristics across the current operating range (10 μA to 1 mA). The recommended part numbers meet these requirements (See 13.). If the Zener selected by user does not ensure that the voltage on the D_z pin is always within the recommended operating range, the functionality and reliability of the GaNFast power IC can be impacted.

Only the following Zener diodes are to be used (Table II).

SYM	DESCRIPTION	PART NO.	SUPPLIER	MIN	TYP	MAX	UNITS
D_z	V_{DD} set Zener diode (D_z pin)	BZT52B6V2 RHG	Taiwan Semiconductor Corporation	5.8	6.2	6.6	V
		MM3Z6V2ST1G	ON-Semiconductor				
		PDZ6.2B.115	Nexperia (NXP)				
		PLVA662A.215	Nexperia (NXP)				
		LM3Z6V2T1	Leshan Radio Company				

Table II. Qualified Zener diode components

An external resistor (~47 kΩ) between V_{CC} and D_Z can improve Zener voltage stability by adding bias current to the D_Z pin to ensure the voltage on the D_Z pin is always within the recommended operating range (Fig. 27). This will add ~200 μA of quiescent current.

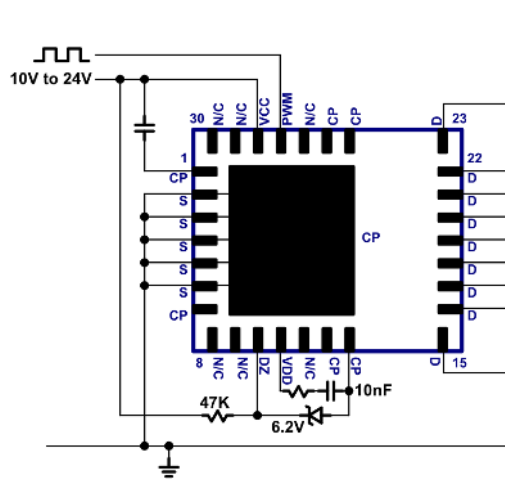

Fig. 27. Increasing Zener bias current for stable Zener voltage

8.10. Drain-to-Source Voltage Considerations

For single ended topologies, such as quasi-resonant (QR) flyback, the drain-to-source voltage (V_{DS}) of the GaN Power IC should be carefully designed in order to ensure there is sufficient derating to provide exceptional quality and long-term reliability. The different voltage stress levels found in a typical QR flyback topology can be analyzed using as a reference. When the device is switched off each cycle, the energy stored in the transformer magnetizing and leakage inductances will cause the V_{DS} to spike to the level of V_{SPIKE} . The clamp circuit of the QR system should be designed such that V_{SPIKE} stays below the Absolute Maximum rated V_{DS} of 650 V on a cycle-by-cycle basis in continuous operation. Following the dissipation of the spike energy due to the leakage inductance, the device V_{DS} will be determined by the addition of the bus voltage (rectified AC input voltage) and the transformer reflected voltage which is defined in as the V_{DS-OFF} . To ensure sufficient design margin and long-term reliability, it is recommended to design the system such that V_{DS-OFF} follows a typical derating of 80% from absolute maximum voltage. Finally, the transient drain-to-source voltage rating (V_{TDS}) is provided in order to provide a margin for events that could occur on a non-repetitive basis, such as line surge due to lightning strikes. V_{TDS} ensures excellent device robustness provided any non-repetitive drain-to-source voltages are maintained less than 750 V. For half-bridge based topologies, such as LLC or PFC, V_{DS} voltage is clamped to the bus voltage. V_{DS} should be designed such that it meets the V_{DS-OFF} derating guideline. The V_{TDS} of 750 V can also be used for non-repetitive events such as lightning surge.

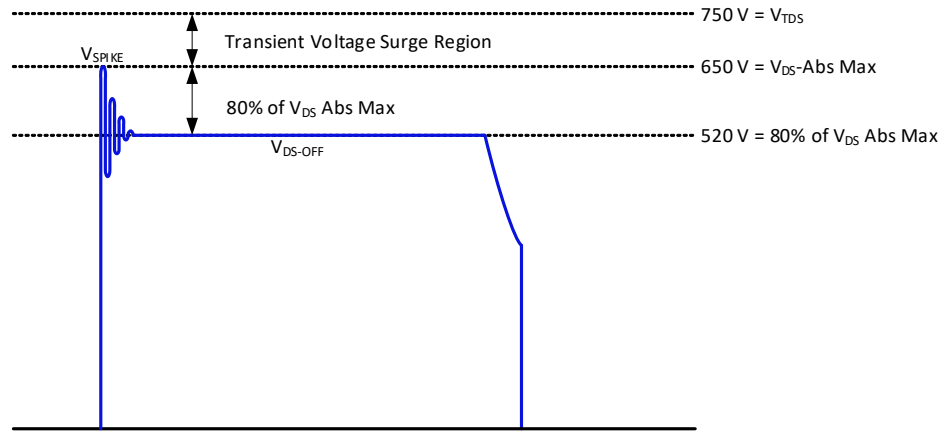
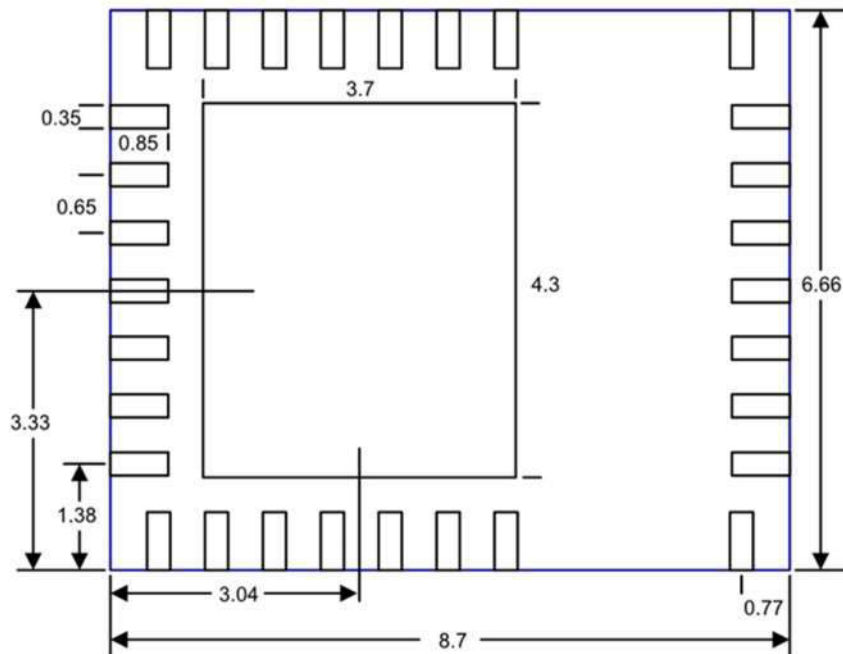

Fig. 28. QR flyback drain-to-source voltage stress diagram

9. Recommended PCB Land Pattern



All dimensions are in mm

10. PCB Layout Guidelines

Without CS Resistor:

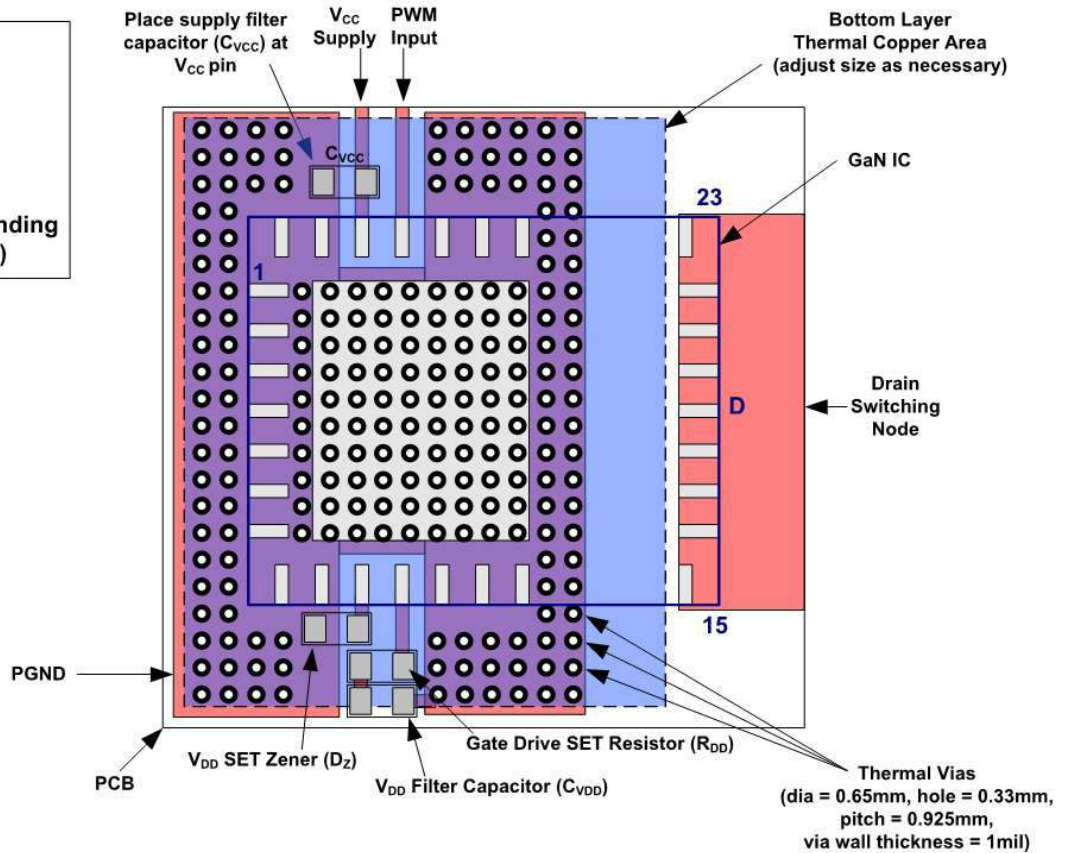
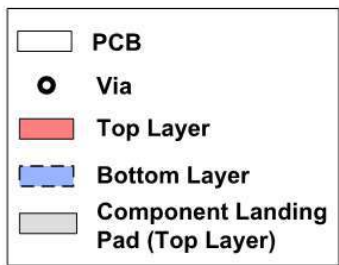
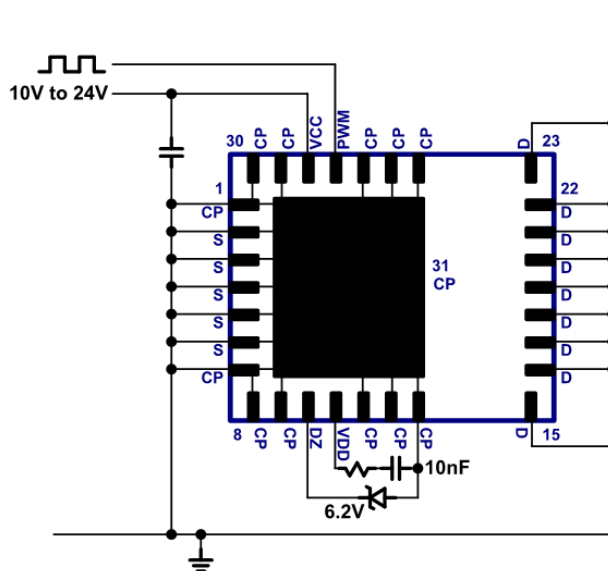

(Top View)

With CS Resistor:

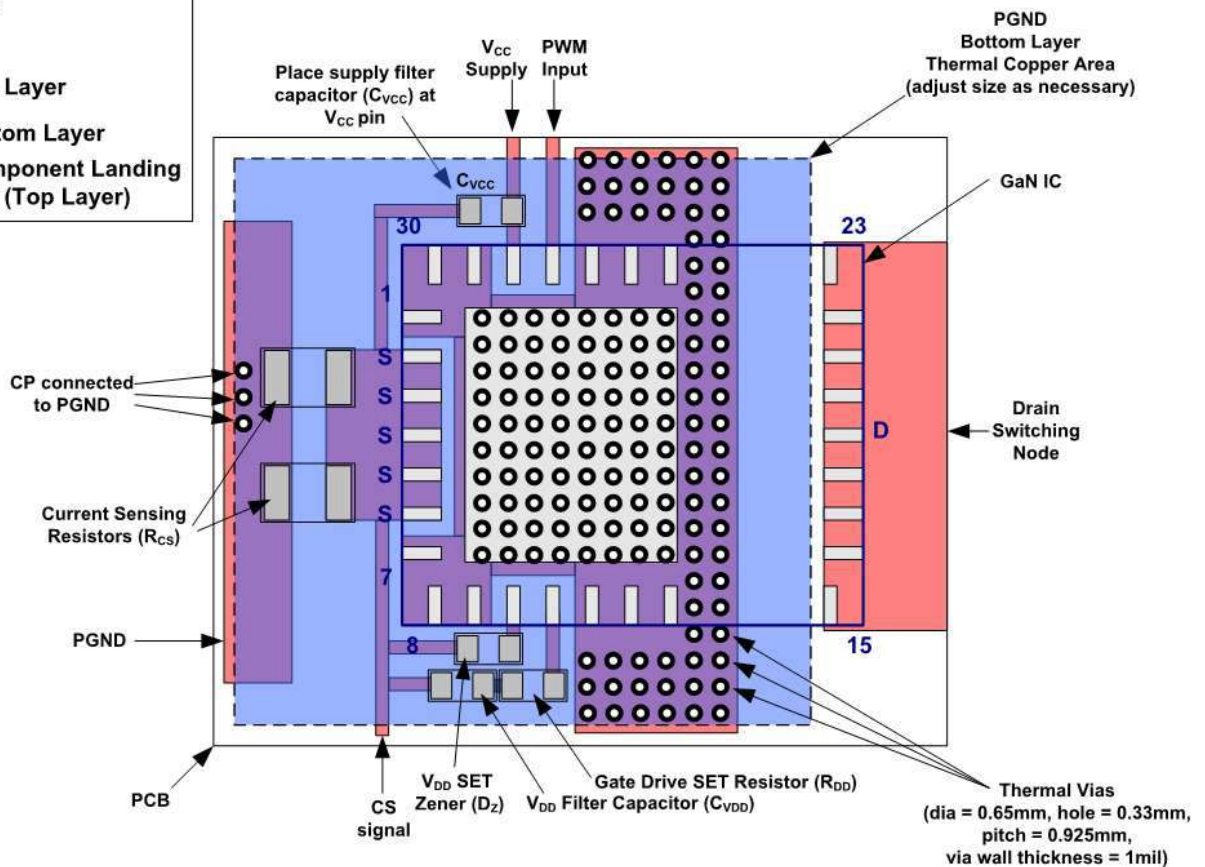
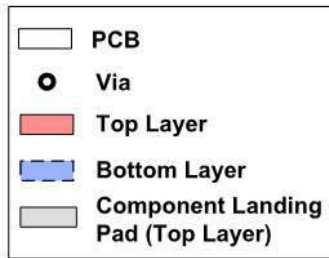
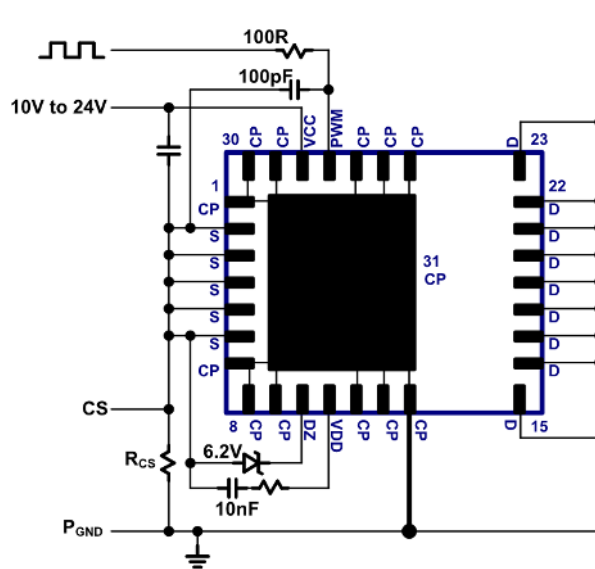

(Top View)

11. QFN Package Outline

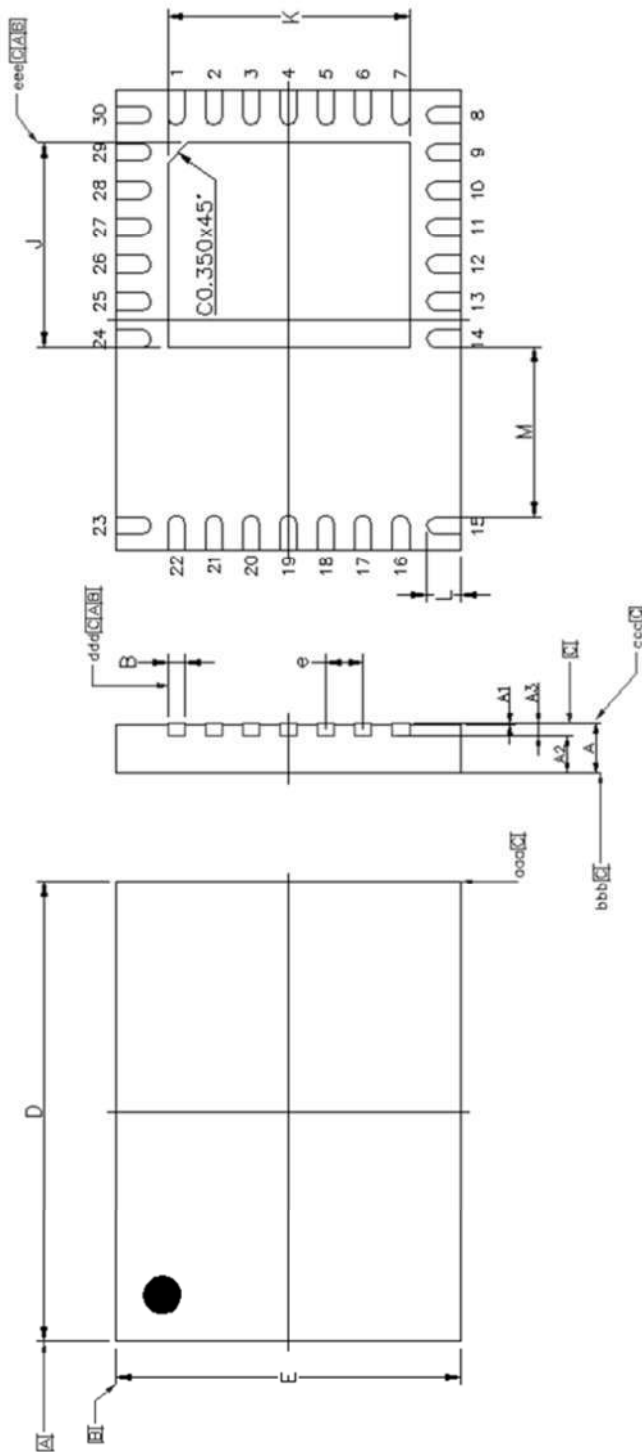

	SYMBOL	MIN	NOM	MAX		SYMBOL	MIN	NOM	MAX
TOTAL THICKNESS	A	0.8	0.85	0.9					
STAND OFF	A1	0.00	0.02	0.05	EP SIZE	X			3.7
MOLD THICKNESS	A2	---	0.65	---		Y			4.3
L/F THICKNESS	A3	---	0.203 REF	---	LEAD LENGTH	L	0.55	0.6	0.65
LEAD WIDTH	B	0.25	0.3	0.35	HIGH VOLTAGE SPACING	M	2.85	2.95	3.05
BODY SIZE	D		8.00 BSC		PACKAGE EDGE TOLERANCE	aaa		0.1	
	E		6.00 BSC		MOLD FLATNESS	bbb		0.1	
LEAD PITCH	e		0.65 BSC		COPLANARITY	ccc		0.08	
					LEAD OFFSET	ddd		0.1	
					EXPOSED PAD OFFSET	eee		0.1	

12. Tape and Reel Dimensions

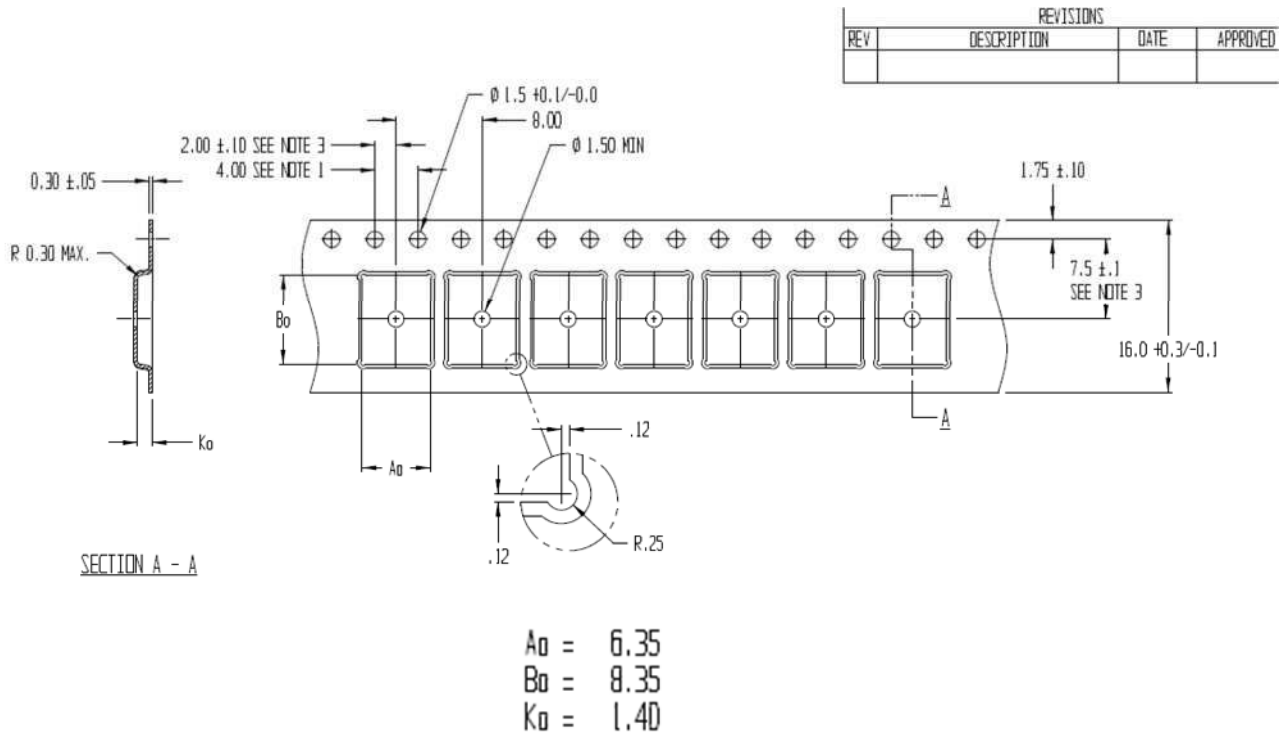

7" Reel

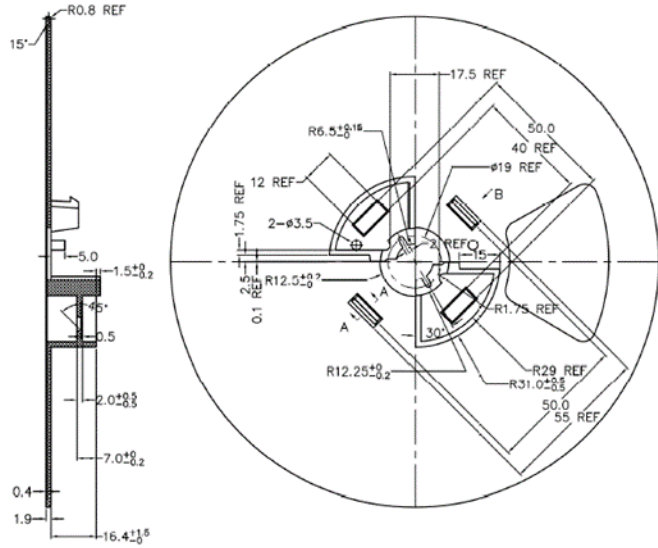
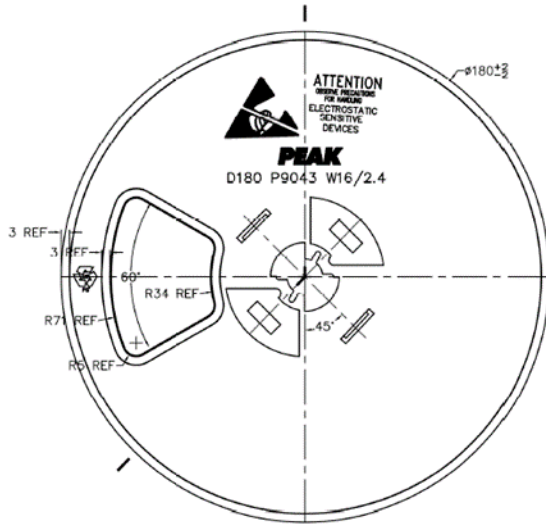

13" Reel

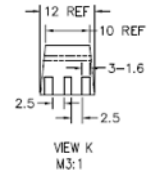
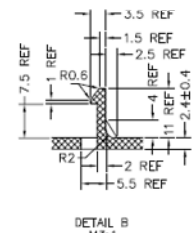
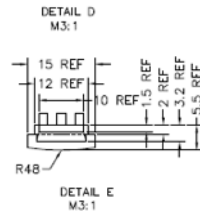
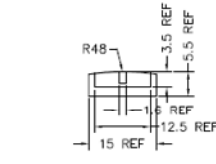
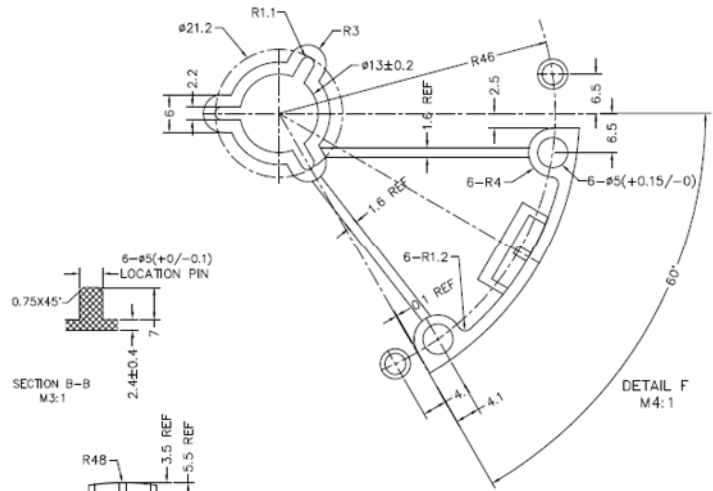
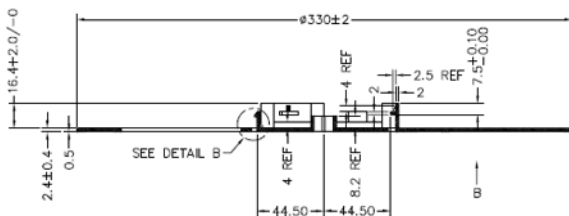
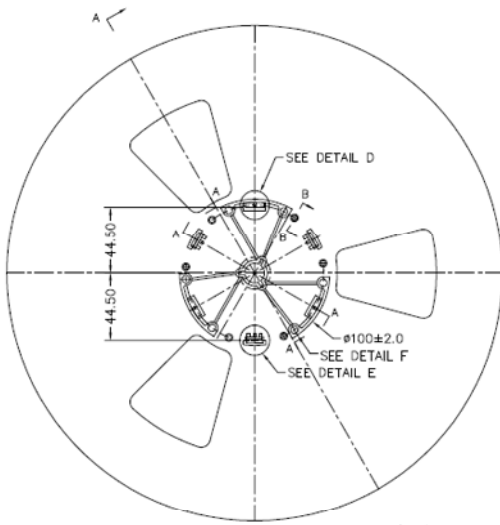

13. Ordering Information

Part Number	Operating Temperature Grade	Storage Temperature Range	Package	MSL Rating	Packing (Tape & Reel)
NV6123 RA	-40 °C to +125 °C T _{CASE}	-55 °C to +150 °C T _{CASE}	6 x 8 mm QFN	1	1,000 : 7" Reel
NV6123	-40 °C to +125 °C TCASE	-55 °C to +150 °C TCASE	6 x 8 mm QFN	1	5,000 : 13" Reel

14. 20-Year Limited Product Warranty

The 20-year limited warranty applies to all packaged Navitas GaNFast Power ICs in mass production, subject to the terms and conditions of, Navitas' express limited product warranty, available at <https://navitassemi.com/terms-conditions>. The warranted specifications include only the MIN and MAX values only listed in Absolute Maximum Ratings, ESD Ratings and Electrical Characteristics sections of this datasheet. Typical (TYP) values or other specifications are not warranted.



15. Revision History

Date	Status	Notes
Aug 18, 2019	Preliminary	First publication
Nov 22, 2019	Initial Release	Added Section 8.10, updated Section 8.3 and figure 22.
Jun 22, 2020	Revision	Updated guidelines in Section 8.1: Fast startup. Updated RDD specification. This datasheet revision applies to product prior to PCN2020-09-15
Oct 27, 2020	Revision	Datasheet updated in alignment with PCN2020-09-15. Product is marked with Lot Code ending in Z for traceability
Apr 11, 2022	Revision	Added 20-Year Limited Product Warranty

Additional Information

DISCLAIMER Navitas Semiconductor Inc. (Navitas) reserves the right to modify the products and/or specifications described herein at any time and at Navitas' sole discretion. All information in this document, including descriptions of product features and performance, is subject to change without notice. Performance specifications and the operating parameters of the described products are determined in the independent state and are not guaranteed to perform the same way when installed in customer products. The information contained herein is provided without representation or warranty of any kind, whether express or implied. This document is presented only as a guide and does not convey any license under intellectual property rights of Navitas or any third parties.

Navitas' products are not intended for use in applications involving extreme environmental conditions or in life support systems.

Products supplied under Navitas [Terms and Conditions](#).

Navitas Semiconductor, Navitas, GaNFast and associated logos are registered trademarks of Navitas.

Copyright ©2022 Navitas Semiconductor Inc. All rights reserved



Contact info@navitassemi.com