

For Immediate Assistance, Contact Your Local Salesperson

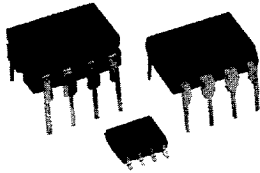

OPA177
OPA77

Precision OPERATIONAL AMPLIFIER

FEATURES

- LOW OFFSET VOLTAGE: 10 μ V max
- LOW DRIFT: 0.1 μ V/ $^{\circ}$ C
- HIGH OPEN-LOOP GAIN: 130dB min
- LOW QUIESCENT CURRENT: 1.5mA typ
- REPLACES INDUSTRY-STANDARD OP AMPS: OP-07, OP-77, OP-177, AD707, ETC.

APPLICATIONS

- PRECISION INSTRUMENTATION
- DATA ACQUISITION
- TEST EQUIPMENT
- BRIDGE AMPLIFIER
- THERMOCOUPLE AMPLIFIER

DESCRIPTION

The OPA177 and OPA77 precision bipolar op amps feature very low offset voltage and drift. Laser-trimmed offset, drift and input bias current virtually eliminate the need for costly external trimming. Their high performance and low cost make them ideally suited to a wide range of precision instrumentation.

The low quiescent current of the OPA177 and OPA77 dramatically reduce warm-up drift and errors due to

thermoelectric effects in input interconnections. They provide an effective alternative to chopper-stabilized amplifiers. The low noise of the OPA177 and OPA77 maintains accuracy.

OPA177 and OPA77 performance gradeouts are available. Packaging options include 8-pin plastic DIP, 8-pin ceramic DIP, and SO-8 surface-mount packages.

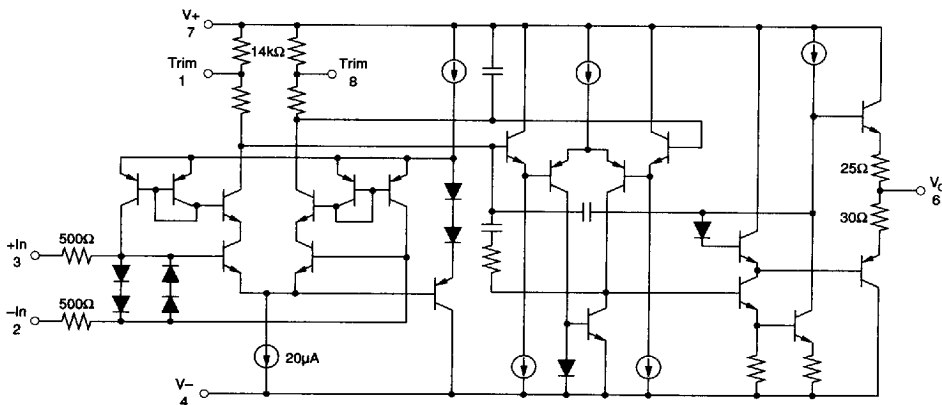

International Airport Industrial Park • Mailing Address: PO Box 11400 • Tucson, AZ 85734 • Street Address: 6730 S. Tucson Blvd. • Tucson, AZ 85706
Tel: (520) 746-1111 • Twx: 910-952-1111 • Cable: BBRCORP • Telex: 066-6491 • FAX: (520) 889-1510 • Immediate Product Info: (800) 548-6132

2.74

PDS-1081C



1731365 0030222 915

Or, Call Customer Service at 1-800-548-6132 (USA Only)

OPA177 SPECIFICATIONS

ELECTRICAL

At $V_S = \pm 15V$, $T_A = +25^\circ C$ unless otherwise noted.

PARAMETER	CONDITION	OPA177E			OPA177F			OPA177G			UNITS
		MIN	TYP	MAX	MIN	TYP	MAX	MIN	TYP	MAX	
OFFSET VOLTAGE											
Input Offset Voltage			4	10		10	25		20	60	μV
Long-Term Input Offset ⁽¹⁾			0.2			0.3			0.4		$\mu V/Mo$
Voltage Stability						*			*		
Offset Adjustment Range	$R_p = 20k\Omega$		± 3			*			*		mV
Power Supply Rejection Ratio	$V_S = \pm 3V$ to $\pm 18V$	120	125		115	*		110	120		dB
INPUT BIAS CURRENT											
Input Offset Current			0.3	1		*	1.5		*	2.8	nA
Input Bias Current			0.5	± 1.5		*	± 2		*	± 2.8	nA
NOISE											
Input Noise Voltage	1Hz to 100Hz ⁽²⁾		85	150		*	*		*	*	nVrms
Input Noise Current	1Hz to 100Hz		4.5			*			*		pArms
INPUT IMPEDANCE											
Input Resistance	Differential Mode ⁽³⁾	26	45		*	*		18.5	*		M Ω
	Common-Mode		200			*			*		G Ω
INPUT VOLTAGE RANGE											
Common-Mode Input Range ⁽⁴⁾		± 13	± 14		*	*		*	*		V
Common-Mode Rejection	$V_{CM} = \pm 13V$	130	140		*	*		115	*		dB
OPEN-LOOP GAIN											
Large Signal Voltage Gain	$R_L \geq 2k\Omega$ $V_O = \pm 10V$ ⁽⁵⁾	5000	12000		*	*		2000	6000		V/mV
OUTPUT											
Output Voltage Swing	$R_L \geq 10k\Omega$ $R_L \geq 2k\Omega$ $R_L \geq 1k\Omega$	± 13.5 ± 12.5 ± 12	± 14 ± 13 ± 12.5 60		*	*		*	*		V V V Ω
Open-Loop Output Resistance					*	*		*	*		
FREQUENCY RESPONSE											
Slew Rate	$R_L \geq 2k\Omega$	0.1	0.3		*	*		*	*		V/ μs
Closed-Loop Bandwidth	$G = +1$	0.4	0.6		*	*		*	*		MHz
POWER SUPPLY											
Power Consumption	$V_S = \pm 15V$, No Load		40	60		*	*		*	*	mW
	$V_S = \pm 3V$, No Load		3.5	4.5		*	*		*	*	mW
Supply Current	$V_S = \pm 15V$, No Load		1.3	2		*	*		*	*	mA

ELECTRICAL

At $V_S = \pm 15V$, $-40^\circ C \leq T_A \leq +85^\circ C$, unless otherwise noted.

OFFSET VOLTAGE												
Input Offset Voltage				10	20		15	40		20	100	μV
Average Input Offset Voltage Drift ⁽⁶⁾				0.03	0.1		0.1	0.3		0.7	1.2	$\mu V/^\circ C$
Power Supply Rejection Ratio	$V_S = \pm 3V$ to $\pm 18V$	120	125			110	120		106	115		dB
INPUT BIAS CURRENT												
Input Offset Current			0.5	1.5		*	2.2		*	4.5		nA
Average Input Offset Current Drift ⁽⁷⁾			1.5	25		*	40		*	85		pA/°C
Input Bias Current			0.5	± 4		*	*		*	± 6		nA
Average Input Bias Current Drift ⁽⁷⁾			8	25		*	40		15	60		pA/°C
INPUT VOLTAGE RANGE												
Common-Mode Input Range		± 13	± 13.5		*	*		*	*			V
Common-Mode Rejection	$V_{CM} = \pm 13V$	120	140		*	*		110	*			dB
OPEN-LOOP GAIN												
Large Signal Voltage Gain	$R_L \geq 2k\Omega$, $V_O = \pm 10V$	2000	6000		*	*		1000	4000			V/mV
OUTPUT												
Output Voltage Swing	$R_L \geq 2k\Omega$	± 12	± 13		*	*		*	*			V
POWER SUPPLY												
Power Consumption	$V_S = \pm 15V$, No Load		60	75		*	*		*	*		mW
Supply Current	$V_S = \pm 15V$, No Load		2	2.5		*	*		*	*		mA

* Same as specification for product to left.

NOTES: (1) Long-Term Input Offset Voltage Stability refers to the averaged trend line of V_{OS} vs time over extended periods after the first 30 days of operation. Excluding the initial hour of operation, changes in V_{OS} during the first 30 operating days are typically less than $2\mu V$. (2) Sample tested. (3) Guaranteed by design. (4) Guaranteed by CMRR test condition. (5) To insure high open-loop gain throughout the $\pm 10V$ output range, A_{OL} is tested at $-10V \leq V_O \leq 0V$, $0V \leq V_O \leq +10V$, and $-10V \leq V_O \leq +10V$. (6) OP177EZ and OP177FZ: TCV_{OS} is 100% tested. (7) Guaranteed by end-point limits.



Burr-Brown IC Data Book—Linear Products

2.75

1731365 0030223 851

For Immediate Assistance, Contact Your Local Salesperson

OPA77 SPECIFICATIONS

ELECTRICAL

At $V_S = \pm 15V$, $T_A = +25^\circ C$ unless otherwise noted.

PARAMETER	CONDITION	OPA77E			OPA77F			OPA77G			UNITS
		MIN	TYP	MAX	MIN	TYP	MAX	MIN	TYP	MAX	
OFFSET VOLTAGE											
Input Offset Voltage			10	25		20	60		50	100	μV
Long-Term Input Offset Voltage Stability ⁽¹⁾			0.3			0.4			*	*	$\mu V/Mo$
Offset Adjustment Range	$R_{TRIM} = 20k\Omega$		± 3			*			*	*	mV
Power Supply Rejection Ratio	$V_S = \pm 3V$ to $\pm 18V$		0.7	3		*	*		*	*	$\mu V/V$
INPUT BIAS CURRENT											
Input Offset Current			0.3	1.5		*	2.8		*	*	nA
Input Bias Current			1.2	± 2		*	± 2.8		*	*	nA
NOISE											
Input Noise Voltage	0.1Hz to 10Hz ⁽²⁾		0.35	0.6		0.38	0.65		*	*	$\mu Vp-p$
Input Noise Voltage Density	$f = 10Hz^{(2)}$		8.5	18		*	20		*	*	nV/ \sqrt{Hz}
	$f = 100Hz^{(2)}$		7.5	13		*	13.5		*	*	nV/ \sqrt{Hz}
	$f = 1000Hz^{(2)}$		7.5	11		*	11.5		*	*	nV/ \sqrt{Hz}
Input Noise Current	0.1Hz to 10Hz		35			*			*	*	pAp-p
Input Noise Current Density	$f = 10Hz$		0.73			*			*	*	pA/ \sqrt{Hz}
	$f = 100Hz$		0.26			*			*	*	pA/ \sqrt{Hz}
	$f = 1000Hz$		0.22			*			*	*	pA/ \sqrt{Hz}
INPUT RESISTANCE											
Differential Input Resistance ⁽³⁾		26	45		18.5	*		*	*		M Ω
Common-mode Input Resistance			200			*		*	*		G Ω
INPUT VOLTAGE RANGE											
Common Mode Input Range		± 13	± 14		*	*		*	*		V
Common-Mode Rejection	$V_{CM} = \pm 13V$		0.1	1		*	1.6		*	*	$\mu V/V$
OPEN-LOOP GAIN											
Large-Signal Voltage Gain	$R_L \geq 2k\Omega$, $V_O = \pm 10V$	5000	12000		2000	6000		*	*		V/mV
OUTPUT											
Output Voltage Swing	$R_L \geq 10k\Omega$	± 13.5	± 14		*	*		*	*		V
	$R_L \geq 2k\Omega$	± 12.5	± 13		*	*		*	*		V
	$R_L \geq 1k\Omega$	± 12	± 12.5		*	*		*	*		V
Open-Loop Output Resistance			60			*			*		Ω
FREQUENCY RESPONSE											
Slew Rate	$R_L \geq 2k\Omega$	0.1	0.3		*	*		*	*		V/ μs
Closed-Loop Bandwidth	$AV_{CL} = +1$	0.4	0.6		*	*		*	*		MHz
POWER SUPPLY											
Power Consumption	$V_S = \pm 15V$, No Load		50	60		*	*		*	*	mW
	$V_S = \pm 3V$, No Load		3.5	4.5		*	*		*	*	mW

ELECTRICAL

At $V_S = \pm 15V$, $-25^\circ C \leq T_A \leq +85^\circ C$ for OPA77EZ and OPA77FZ, $0^\circ C \leq T_A \leq +70^\circ C$ for OPA77FP and OPA77GP, unless otherwise noted.

OFFSET VOLTAGE											
Input Offset Voltage	Z Package		10	45		20	100		*	*	μV
	P Package		10	55		20	100		80	150	μV
Average Input Offset ⁽⁴⁾	Z Package		0.1	0.3		0.2	0.6		*	*	$\mu V/^\circ C$
Voltage Drift	P Package		0.3	0.6		0.4	1		0.7	1.2	$\mu V/^\circ C$
Power Supply Rejection Ratio	$V_S = \pm 3V$ to $\pm 18V$		1	3		*	5		*	*	$\mu V/V$
INPUT BIAS CURRENT											
Input Offset Current			0.5	2.2		*	4.5		*	*	nA
Avg Input Offset Current Drift ⁽⁵⁾			1.5	40		*	85		*	*	pA/ $^\circ C$
Input Bias Current			2.4	± 4		*	± 6		*	*	nA
Avg Input Bias Current Drift ⁽⁵⁾			8	40		15	60		*	*	pA/ $^\circ C$
INPUT VOLTAGE RANGE											
Common Mode Input Range		± 13	± 13.5		*	*		*	*		V
Common-Mode Rejection	$V_{CM} = \pm 13V$		0.1	1		*	3		*	*	$\mu V/V$
OPEN-LOOP GAIN											
Large Signal Voltage Gain	$R_L \geq 2k\Omega$, $V_O = \pm 10V$	2000	6000		1000	4000		*	*		V/mV
OUTPUT											
Output Voltage Swing	$R_L \geq 2k\Omega$	± 12	± 13		*	*		*	*		V
POWER SUPPLY											
Power Consumption	$V_S = \pm 15V$, No Load		60	75		*	*		*	*	mW

* Same as specification for product to left. NOTES: (1) Long-Term Input Offset Voltage Stability refers to the averaged trend line of V_{OS} vs time over extended period after the first 30 days of operation. Excluding the initial hour of operation, changes in V_{OS} during the first 30 operating days are typically $2.5\mu V$. (2) Sample tested. (3) Guaranteed by design. (4) OPA77E: TCV_{OS} is 100% tested on Z package. (5) Guaranteed by end-point limits.

DICE INFORMATION

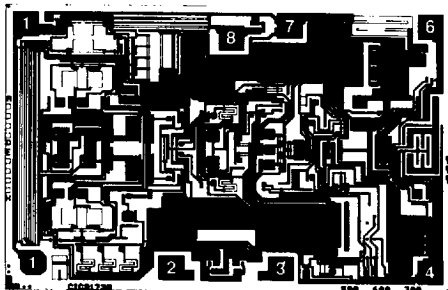

OPA177/77 DIE TOPOGRAPHY

PAD	FUNCTION
1	Offset Trim
2	-In
3	+In
4	V-
5	NC
6	V _o
7	V+
8	Offset Trim

Substrate Bias: -V_S
NC: No Connection.

MECHANICAL INFORMATION

	MILS (0.001")	MILLIMETERS
Die Size	63 x 92 ±5	1.60 x 2.34 ±0.13
Die Thickness	20 ±3	0.51 ±0.08
Min. Pad Size	4 x 4	0.10 x 0.10
Transistor Count	46	
Backing	Gold	

PIN CONFIGURATION

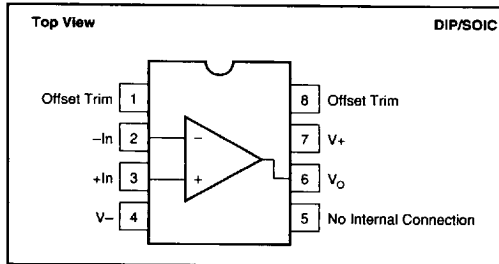

ABSOLUTE MAXIMUM RATINGS

Power Supply Voltage	±22V
Differential Input Voltage	±30V
Input Voltage	±V _S
Output Short Circuit	Continuous
Operating Temperature:	
Ceramic DIP (Z)	-55°C to +125°C
Plastic DIP (P), SO-8 (S)	-40°C to +85°C
θ _{JA} (PDIP)	100°C/W
θ _{JA} (SOIC)	160°C/W
θ _{JA} (Ceramic)	148°C/W
Storage Temperature:	
Ceramic DIP (Z)	-65°C to +150°C
Plastic DIP (P), SO-8 (S)	-65°C to +125°C
Junction Temperature	+150°C
Lead Temperature (soldering, 10s) P, Z packages	+300°C
(soldering, 3s) S package	+260°C

ORDERING INFORMATION

MODEL	PACKAGE	TEMP. RANGE
OPA177FP	8-Pin Plastic DIP	-40°C to +85°C
OPA177GP	8-Pin Plastic DIP	-40°C to +85°C
OPA177GS	SO-8 Surface-Mount	-40°C to +85°C
OPA177EZ	8-Pin Ceramic DIP	-40°C to +85°C
OPA177FZ	8-Pin Ceramic DIP	-40°C to +85°C
OPA177GZ	8-Pin Ceramic DIP	-40°C to +85°C
OPA77FP	8-Pin Plastic DIP	0°C to +70°C
OPA77GP	8-Pin Plastic DIP	0°C to +70°C
OPA77EZ	8-Pin Ceramic DIP	-25°C to +85°C
OPA77FZ	8-Pin Ceramic DIP	-25°C to +85°C

PACKAGE INFORMATION

MODEL	PACKAGE	PACKAGE DRAWING NUMBER ⁽¹⁾
OPA177FP	8-Pin Plastic DIP	006
OPA177GP	8-Pin Plastic DIP	006
OPA177GS	SO-8 Surface-Mount	182
OPA177EZ	8-Pin Ceramic DIP	254
OPA177FZ	8-Pin Ceramic DIP	254
OPA177GZ	8-Pin Ceramic DIP	254
OPA77FP	8-Pin Plastic DIP	006
OPA77GP	8-Pin Plastic DIP	006
OPA77EZ	8-Pin Ceramic DIP	254
OPA77FZ	8-Pin Ceramic DIP	254

NOTE: (1) For detailed drawing and dimension table, please see end of data sheet, or Appendix C of Burr-Brown IC Data Book.



For Immediate Assistance, Contact Your Local Salesperson

TYPICAL PERFORMANCE CURVES

$T_A = +25^\circ\text{C}$, $V_S = \pm 15\text{V}$ unless otherwise noted.

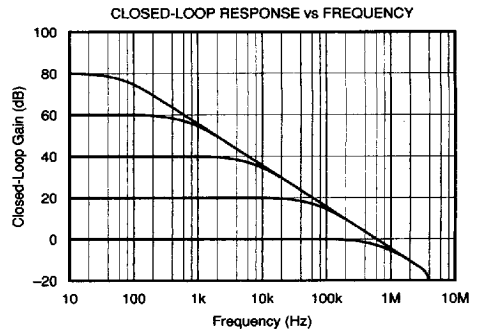
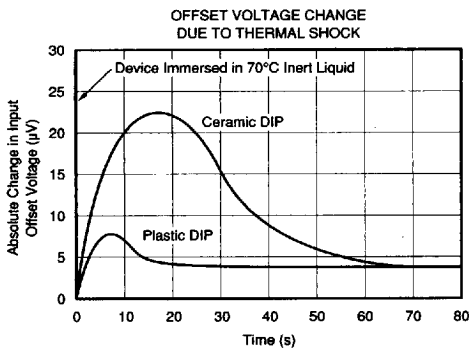
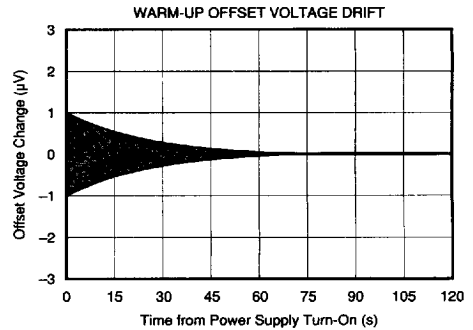
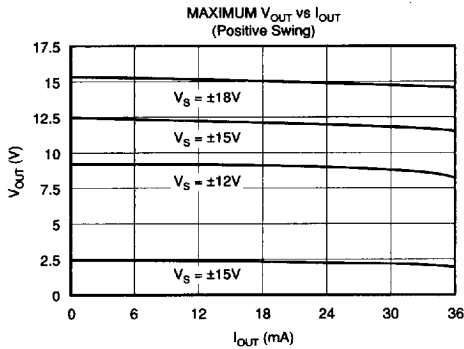
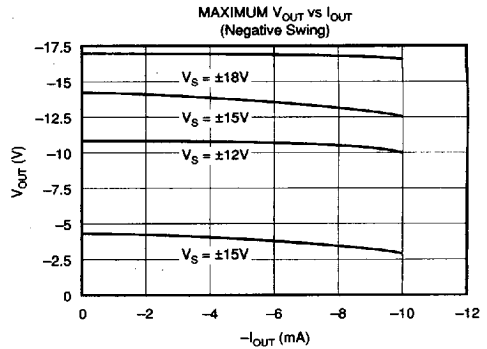
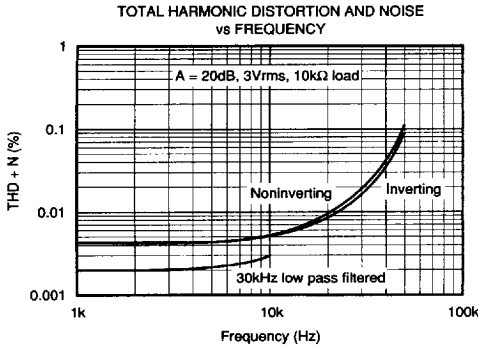

Or, Call Customer Service at 1-800-548-6132 (USA Only)

TYPICAL PERFORMANCE CURVES (CONT)

$T_A = +25^\circ\text{C}$, $V_S = \pm 15\text{V}$ unless otherwise noted.

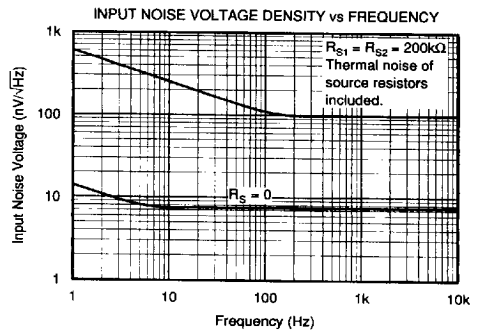
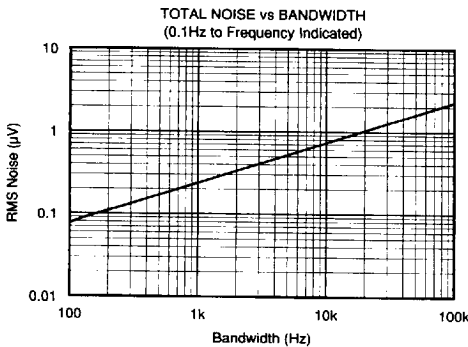
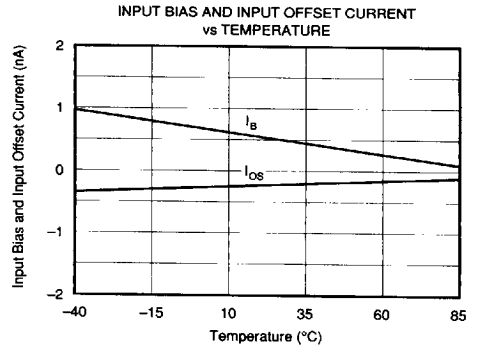
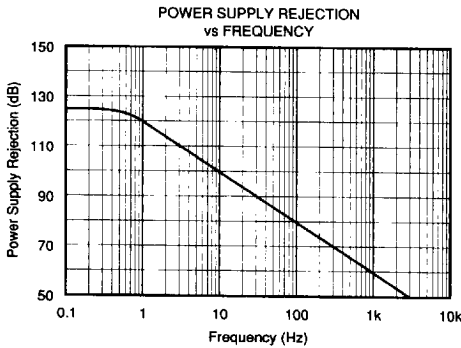
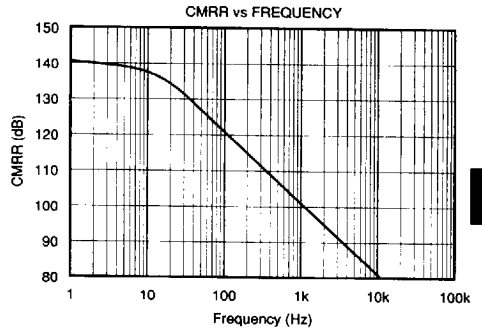
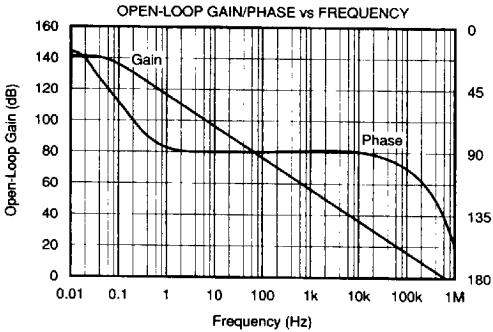

2 OPA17777 OPERATIONAL AMPLIFIERS



Burr-Brown IC Data Book—Linear Products

1731365 0030227 4T7

2.79

For Immediate Assistance, Contact Your Local Salesperson

TYPICAL PERFORMANCE CURVES (CONT)

$T_A = +25^\circ\text{C}$, $V_S = \pm 15\text{V}$ unless otherwise noted.

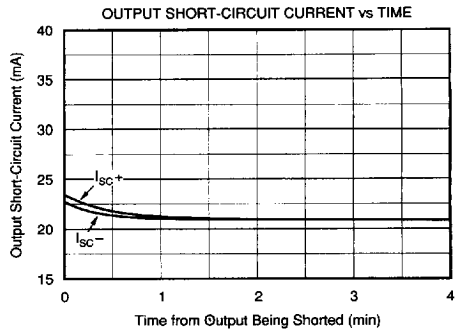
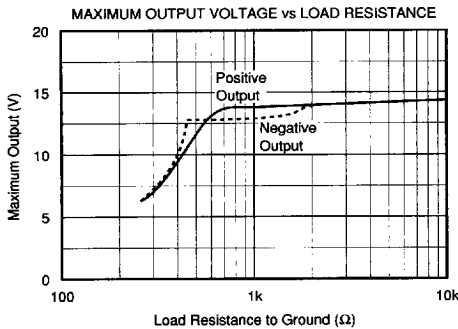
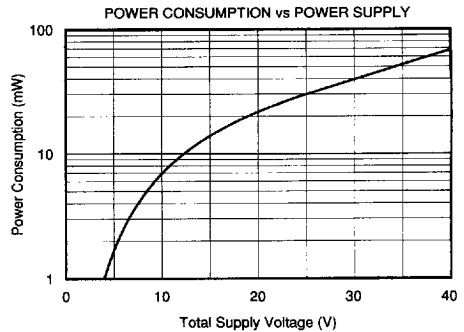
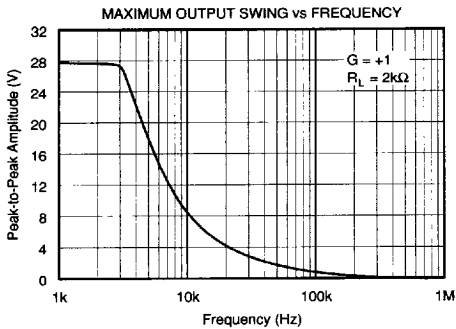

ELECTROSTATIC DISCHARGE SENSITIVITY

Any integrated circuit can be damaged by ESD. Burr-Brown recommends that all integrated circuits be handled with appropriate precautions. ESD can cause damage ranging from subtle performance degradation to complete device failure. Precision integrated circuits may be more susceptible to damage because very small parametric changes could cause the device not to meet published specifications.

Burr-Brown's standard ESD test method consists of five 1000V positive and negative discharges (100pF in series with 1.5k Ω) applied to each pin.

Failure to observe proper handling procedures could result in small changes to the OPA177's input bias current.

The information provided herein is believed to be reliable; however, BURR-BROWN assumes no responsibility for inaccuracies or omissions. BURR-BROWN assumes no responsibility for the use of this information, and all use of such information shall be entirely at the user's own risk. Prices and specifications are subject to change without notice. No patent rights or licenses to any of the circuits described herein are implied or granted to any third party. BURR-BROWN does not authorize or warrant any BURR-BROWN product for use in life support devices and/or systems.

APPLICATIONS INFORMATION

The OPA177 is unity-gain stable, making it easy to use and free from oscillations in the widest range of circuitry. Applications with noisy or high impedance power supply lines may require decoupling capacitors close to the device pins. In most cases 0.1 μ F ceramic capacitors are adequate.

The OPA177 has very low offset voltage and drift. To achieve highest performance, circuit layout and mechanical conditions must be optimized. Offset voltage and drift can be degraded by small thermoelectric potentials at the op amp inputs. Connections of dissimilar metals will generate thermal potential which can mask the ultimate performance of the OPA177. These thermal potentials can be made to cancel by assuring that they are equal in both input terminals.

1. Keep connections made to the two input terminals close together.
2. Locate heat sources as far as possible from the critical input circuitry.
3. Shield the op amp and input circuitry from air currents such as cooling fans.

OFFSET VOLTAGE ADJUSTMENT

The OPA177 and OPA77 have been laser-trimmed for low offset voltage and drift so most circuits will not require external adjustment. Figure 1 shows the optional connection of an external potentiometer to adjust offset voltage. This adjustment should not be used to compensate for offsets created elsewhere in a system since this can introduce excessive temperature drift.

INPUT PROTECTION

The inputs of the OPA177 and OPA77 are protected with 500 Ω series input resistors and diode clamps as shown in the simplified circuit diagram. The inputs can withstand ± 30 V differential inputs without damage. The protection diodes will, of course, conduct current when the inputs are overdriven. This may disturb the slewing behavior of unity-gain follower applications, but will not damage the op amp.

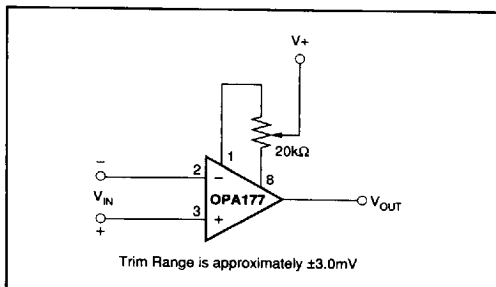

FIGURE 1. Optional Offset Nulling Circuit.

NOISE PERFORMANCE

The noise performance of the OPA177 and OPA77 is optimized for circuit impedances in the range of 2k Ω to 50k Ω . Total noise in an application is a combination of the op amp's input voltage noise and input bias current noise reacting with circuit impedances. For applications with higher source impedance, the OPA627 FET-input op amp will generally provide lower noise. For very low impedance applications, the OPA27 will provide lower noise.

INPUT BIAS CURRENT CANCELLATION

The input stage base current of the OPA177 is internally compensated with an equal and opposite cancellation current. The resulting input bias current is the difference between the input stage base current and the cancellation current. This residual input bias current can be positive or negative.

When the bias current is cancelled in this manner, the input bias current and input offset current are approximately the same magnitude. As a result, it is not necessary to balance the DC resistance seen at the two input terminals (Figure 2). A resistor added to balance the input resistances may actually increase offset and noise.

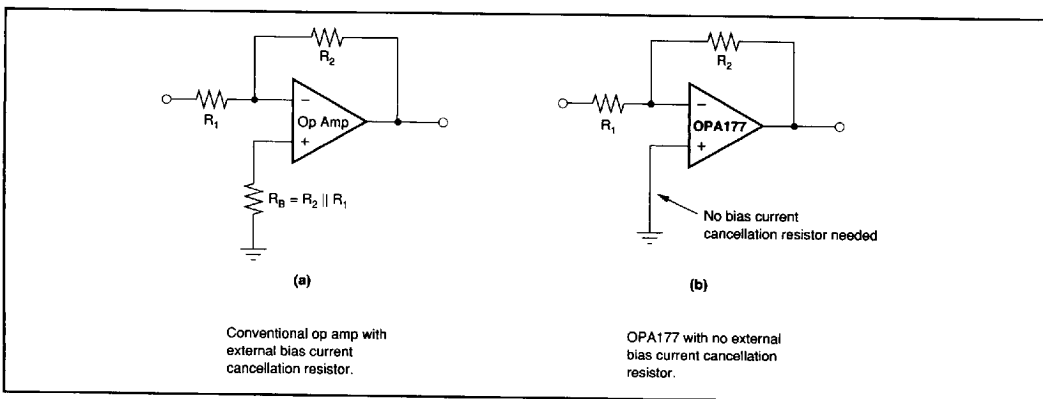

FIGURE 2. Input Bias Current Cancellation.

