

## 3000 W TVS in SMC



Bidirectional

Unidirectional

### Product status link

[SMC30J5.0A](#), [SMC30J5.0CA](#),  
[SMC30J6.0A](#), [SMC30J6.0CA](#),  
[SMC30J6.5A](#), [SMC30J6.5CA](#),  
[SMC30J8.5A](#), [SMC30J8.5CA](#),  
[SMC30J10A](#), [SMC30J10CA](#),  
[SMC30J12A](#), [SMC30J12CA](#),  
[SMC30J13A](#), [SMC30J13CA](#),  
[SMC30J15A](#), [SMC30J15CA](#),  
[SMC30J16A](#), [SMC30J16CA](#),  
[SMC30J18A](#), [SMC30J18CA](#),  
[SMC30J20A](#), [SMC30J20CA](#),  
[SMC30J22A](#), [SMC30J22CA](#),  
[SMC30J24A](#), [SMC30J24CA](#),  
[SMC30J26A](#), [SMC30J26CA](#),  
[SMC30J28A](#), [SMC30J28CA](#),  
[SMC30J30A](#), [SMC30J30CA](#),  
[SMC30J33A](#), [SMC30J33CA](#),  
[SMC30J36A](#), [SMC30J36CA](#),  
[SMC30J40A](#), [SMC30J40CA](#),  
[SMC30J48A](#), [SMC30J48CA](#),  
[SMC30J58A](#), [SMC30J58CA](#),  
[SMC30J64A](#), [SMC30J64CA](#),  
[SMC30J70A](#), [SMC30J70CA](#),  
[SMC30J85A](#), [SMC30J85CA](#),  
[SMC30J100A](#), [SMC30J100CA](#),  
[SMC30J130A](#), [SMC30J130CA](#),  
[SMC30J154A](#), [SMC30J154CA](#),  
[SMC30J170A](#), [SMC30J170CA](#),  
[SMC30J188A](#), [SMC30J188CA](#)

### Features

- Peak pulse power:
  - 3000 W (10/1000  $\mu$ s)
  - up to 40 kW (8/20  $\mu$ s)
- Stand-off voltage range from 5 V to 188 V
- Unidirectional and bidirectional types
- Low leakage current: 0.2  $\mu$ A at 25 °C
- Operating  $T_j$  max: 175 °C
- JEDEC registered package outline
- Resin meets UL94, V0
- Lead finishing: matte tin plating

### Complies with the following standards

- UL94, V0
- J-STD-020 MSL level 1
- J-STD-002, JESD 22-B102 E3 and MIL-STD-750, method 2026
- JESD-201 class 2 whisker test
- IPC7531 footprint and JEDEC registered package outline
- IEC 61000-4-4 level 4:
  - 4 kV
- IEC 61000-4-2, C = 150 pF, R = 330  $\Omega$  exceeds level 4:
  - 30 kV (air discharge)
  - 30 kV (contact discharge)

### Description

The SMC30J TVS series are designed to protect sensitive equipment against electrostatic discharges according to IEC 61000-4-2, MIL STD 883 Method 3015, and electrical overstress such as IEC 61000-4-4 and 5. They are used for surges below 3000 W 10/1000  $\mu$ s.

This planar technology makes it compatible with high-end equipment and SMPS where low leakage current and high junction temperature are required to provide reliability and stability over time.

# 1 Characteristics

**Table 1. Absolute maximum ratings ( $T_{amb} = 25\text{ }^{\circ}\text{C}$ )**

Symbol	Parameter	Value	Unit	
$V_{PP}$	Peak pulse voltage	IEC 61000-4-2 (C = 150 pF, R = 330 $\Omega$ )		
		Contact discharge	30	kV
		Air discharge	30	
$P_{PP}$	Peak pulse power dissipation	$T_j$ initial = $T_{amb}$	3000	W
$T_{stg}$	Storage temperature range		-65 to +175	$^{\circ}\text{C}$
$T_j$	Operating junction temperature range		-55 to +175	$^{\circ}\text{C}$
$T_L$	Maximum lead temperature for soldering during 10 s		260	$^{\circ}\text{C}$

**Figure 1. Electrical characteristics - parameter definitions**

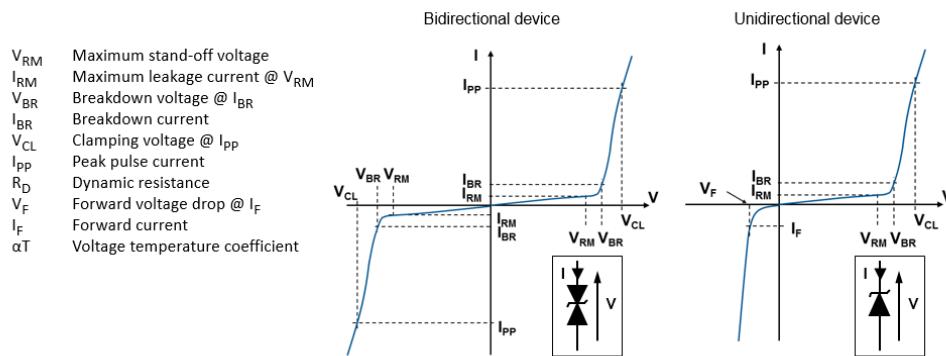

**Figure 2. Pulse definition for electrical characteristics**

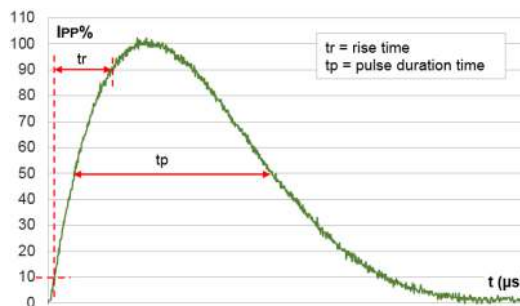

**Table 2. Electrical characteristics - parameter values ( $T_{amb} = 25\text{ }^{\circ}\text{C}$ , unless otherwise specified)**

Type	$I_{RM}$ max at $V_{RM}$			$V_{BR}$ at $I_R$ <sup>(1)</sup>				10 / 1000 $\mu\text{s}$			8 / 20 $\mu\text{s}$			$\alpha T$
	25 $^{\circ}\text{C}$	85 $^{\circ}\text{C}$		Min.	Typ.	Max.		$V_{CL}$ <sup>(2)(3)</sup>	$I_{PP}$ <sup>(4)</sup>	$R_D$	$V_{CL}$ <sup>(2)(3)</sup>	$I_{PP}$ <sup>(4)</sup>	$R_D$	Max.
								Max.		Max.	Max.		Max.	Max.
	$\mu\text{A}$			V	V			mA	V	A	m $\Omega$	V	A	m $\Omega$
SMC30J5.0A/CA	500	50	5	6.4	6.74	7.1	10	9.2	327	6.42	14.4	1610	4.53	5.7
SMC30J6.0A/CA	500	50	6	6.7	7.05	7.4	10	10.3	291	9.97	14.7	1580	4.62	5.9
SMC30J6.5A/CA	250	50	6.5	7.2	7.58	7.9	10	11.2	268	12.3	15.2	1530	4.77	6.1
SMC30J8.5A/CA	10	50	8.5	9.4	9.9	10.5	1	14.4	208	18.8	18.6	1280	6.33	7.3
SMC30J10A/CA	0.2	1	10	11.1	11.7	12.6	1	17	176	25	21.7	1170	7.78	7.8
SMC30J12A/CA	0.2	1	12	13.3	14	14.7	1	19.9	151	34.4	25.3	1045	10.1	8.3
SMC30J13A/CA	0.2	1	13	14.4	15.2	15.8	1	21.5	140	40.7	27.2	993	11.5	8.4
SMC30J15A/CA	0.2	1	15	16.7	17.6	18.5	1	24.4	123	48	32.5	926	15.1	8.8
SMC30J16A/CA	0.2	1	16	17.8	18.7	19.6	1	26	115	55.7	34.4	868	17.1	8.8
SMC30J18A/CA	0.2	1	18	20	21.1	22.2	1	29.2	103	68	39.3	800	21.4	9.2
SMC30J20A/CA	0.2	1	20	22.2	23.4	24.6	1	32.4	93	83.9	42.8	747	24.4	9.4
SMC30J22A/CA	0.2	1	22	24.4	25.7	27	1	35.5	85	100	48.3	701	30.4	9.6
SMC30J24A/CA	0.2	1	24	26.7	28.1	29.5	1	38.9	77	122	50	660	31.1	9.6
SMC30J26A/CA	0.2	1	26	28.9	30.4	31.9	1	42.1	71	144	53.5	626	34.5	9.7
SMC30J28A/CA	0.2	1	28	31.1	32.7	34.3	1	45.4	66	168	59	596	41.4	9.8
SMC30J30A/CA	0.2	1	30	33.3	35.1	36.9	1	48.4	62	185	64.3	569	48.2	9.9
SMC30J33A/CA	0.2	1	33	36.7	38.6	40.5	1	53.3	56	229	69.7	526	55.5	10
SMC30J36A/CA	0.2	1	36	40	42.1	44.2	1	58.1	48.4	287	76	503	63.2	10
SMC30J40A/CA	0.2	1	40	44.4	46.7	49	1	64.5	43.5	356	84	469	74.6	10.1
SMC30J48A/CA	0.2	1	48	53.2	56	58.8	1	76.6	38	468	100	409	101	10.3
SMC30J58A/CA	0.2	1	58	64.6	68	71.4	1	93.6	32	694	121	325	153	10.4
SMC30J64A/CA	0.2	1	64	71.3	75	78.8	1	103	29.1	832	134	289	191	10.5
SMC30J70A/CA	0.2	1	70	77.9	82	86.1	1	113	26.5	1015	146	256	234	10.5
SMC30J85A/CA	0.2	1	85	95	100	105	1	137	22	1455	178	205	356	10.6
SMC30J100A/CA	0.2	1	100	111	117	123	1	162	19	2053	212	170	524	10.7
SMC30J130A/CA	0.2	1	130	144	152	160	1	209	14	3500	265	125	840	10.8
SMC30J154A/CA	0.2	1	154	171	180	189	1	246	12	4750	317	102	1255	10.8
SMC30J170A/CA	0.2	1	170	190	200	210	1	275	11	5909	353	90	1589	10.8
SMC30J188A/CA	0.2	1	188	209	220	231	1	328	9	10778	388	80	1963	10.8

1. To calculate  $V_{BR}$  versus  $T_j$ :  $V_{BR}$  at  $T_j = V_{BR}$  at  $25\text{ }^{\circ}\text{C} \times (1 + \alpha T \times (T_j - 25))$
2. To calculate  $V_{CL}$  versus  $T_j$ :  $V_{CL}$  at  $T_j = V_{CL}$  at  $25\text{ }^{\circ}\text{C} \times (1 + \alpha T \times (T_j - 25))$
3. To calculate  $V_{CL}$  max versus  $I_{PP\text{appli}}$ :  $V_{CL\text{max}} = V_{CL} - R_D \times (I_{PP} - I_{PP\text{appli}})$  where  $I_{PP\text{appli}}$  is the surge current in the application
4. Surge capability given for both directions for unidirectional and bidirectional devices

### 1.1 Characteristics (curves)

**Figure 3. Maximum peak power dissipation versus initial junction temperature**

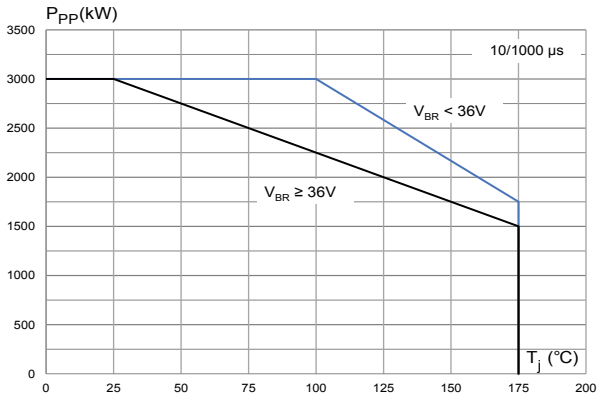

**Figure 4. Maximum peak pulse power versus exponential pulse duration**

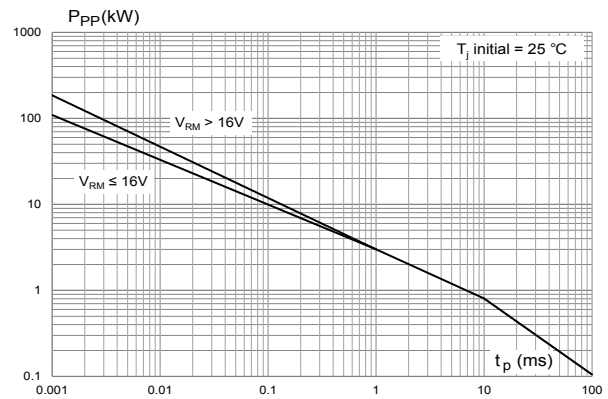

**Figure 5. Maximum peak pulse current versus clamping voltage**

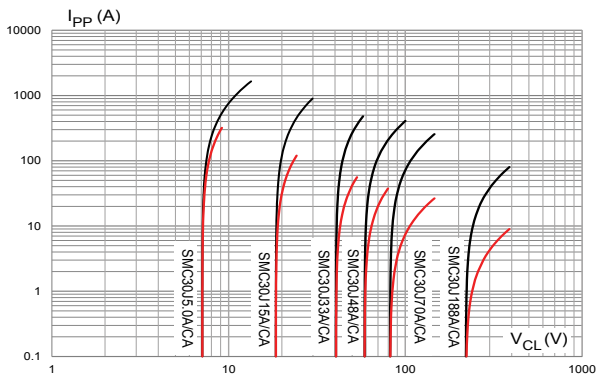

**Figure 6. Dynamic resistance versus pulse duration**

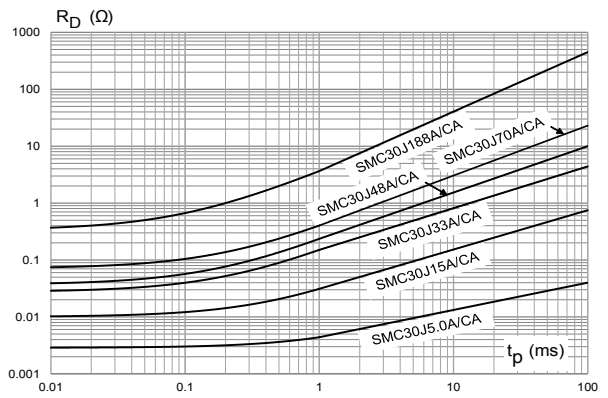

**Figure 7. Junction capacitance versus reverse applied voltage (unidirectional type)**

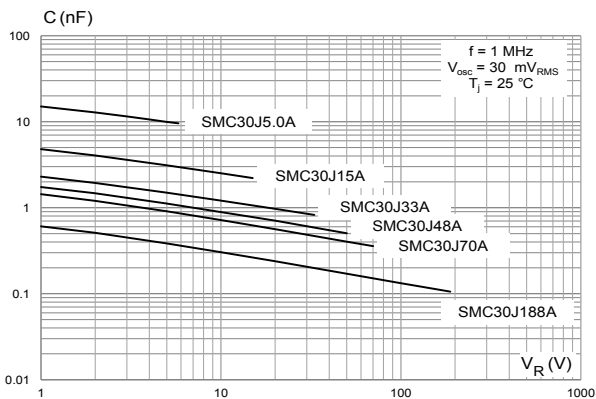

**Figure 8. Junction capacitance versus applied voltage (bidirectional type)**

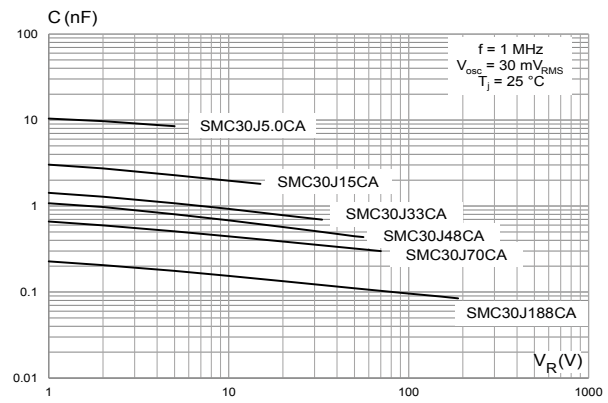

Figure 9. Leakage current versus junction temperature

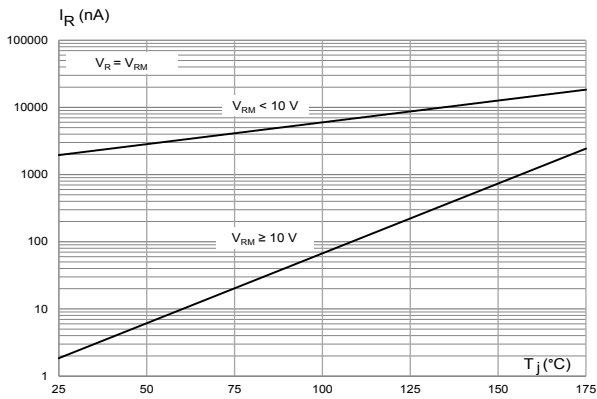

Figure 10. Peak forward voltage drop versus peak forward current

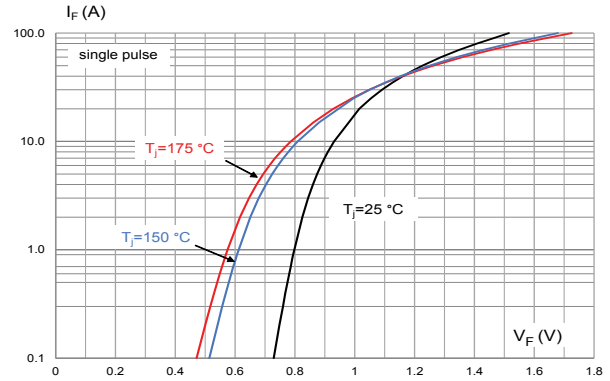

Figure 11. Thermal impedance junction to ambient versus pulse duration

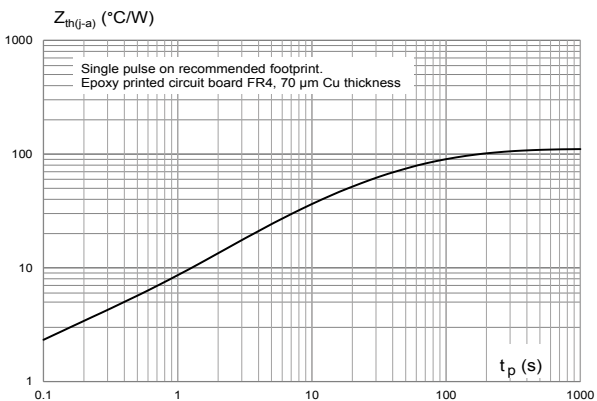
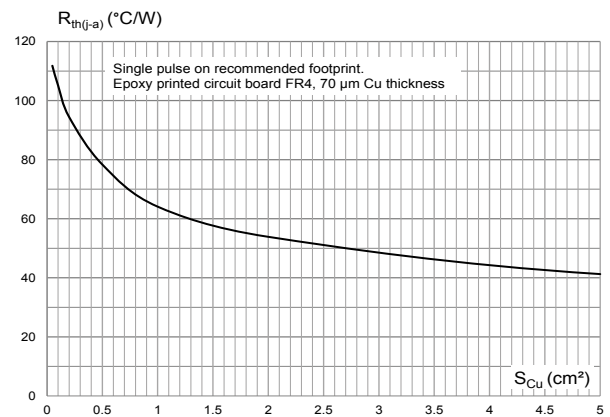

Figure 12. Thermal resistance junction to ambient versus copper area under each lead



## 2 Package information

In order to meet environmental requirements, ST offers these devices in different grades of **ECOPACK** packages, depending on their level of environmental compliance. ECOPACK specifications, grade definitions and product status are available at: [www.st.com](http://www.st.com). ECOPACK is an ST trademark.

### 2.1 SMC package information

Figure 13. SMC package outline

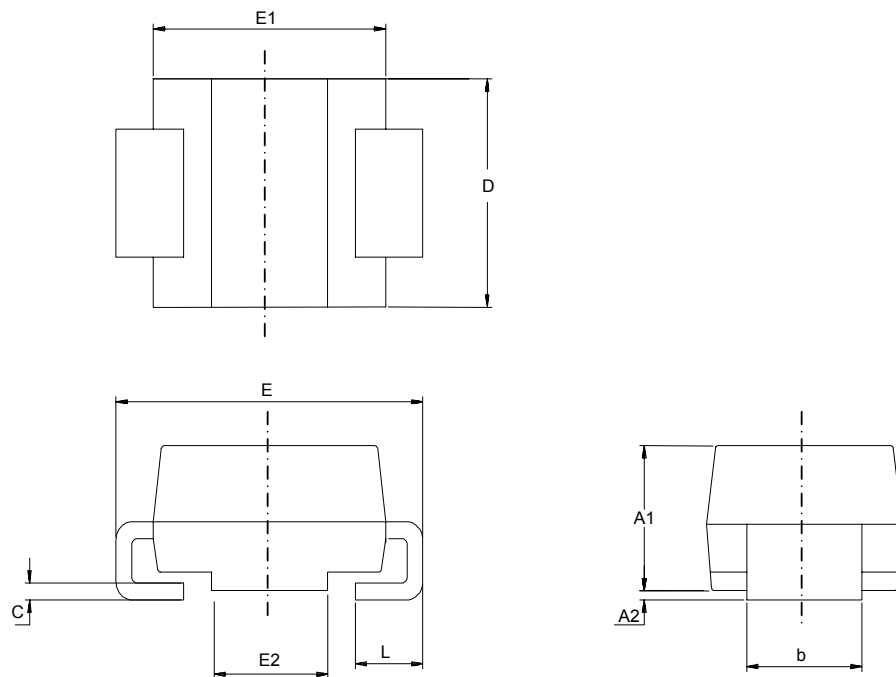

Table 3. SMC package mechanical data

Ref.	Dimensions			
	Millimeters		Inches (for reference only)	
	Min.	Max.	Min.	Max.
A1	1.90	2.45	0.075	0.096
A2	0.05	0.20	0.002	0.008
b	2.90	3.20	0.114	0.126
c	0.15	0.40	0.006	0.016
D	5.55	6.25	0.218	0.246
E	7.75	8.15	0.305	0.321
E1	6.60	7.15	0.260	0.281
E2	4.40	4.70	0.173	0.185
L	0.75	1.50	0.030	0.060

Figure 14. Footprint recommendation

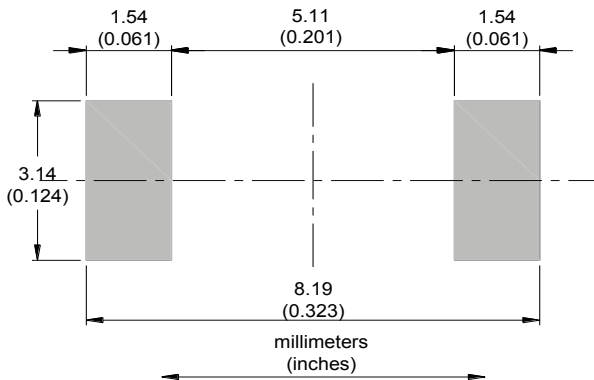

Figure 15. Marking layout

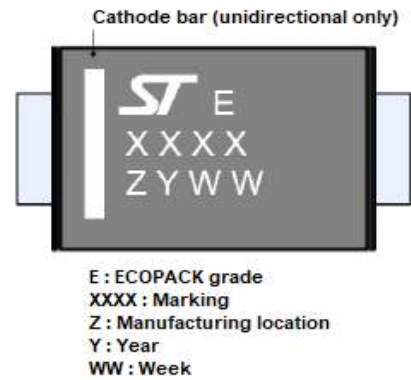
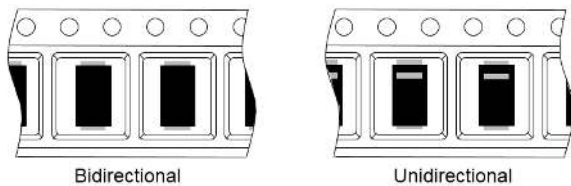

Figure 16. Package orientation in reel



Taped according to EIA-481  
Pocket dimensions are not on scale.  
Pocket shape may vary depending on package  
On bidirectional devices, marking and logo may not be always in the same direction.

Figure 17. Tape and reel orientation

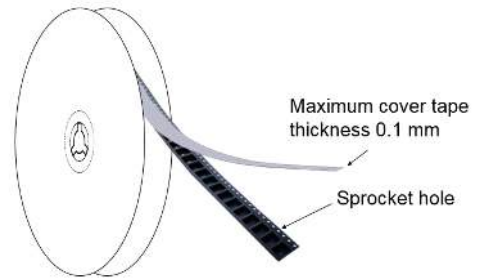

Figure 18. 13" reel dimension values (mm)

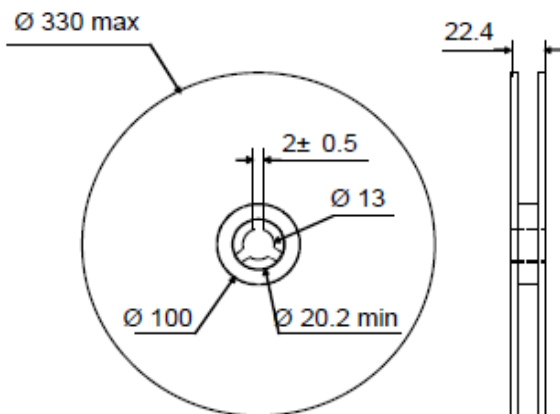

Figure 19. Inner box dimension values (mm)

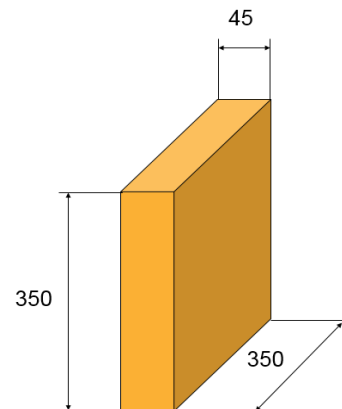
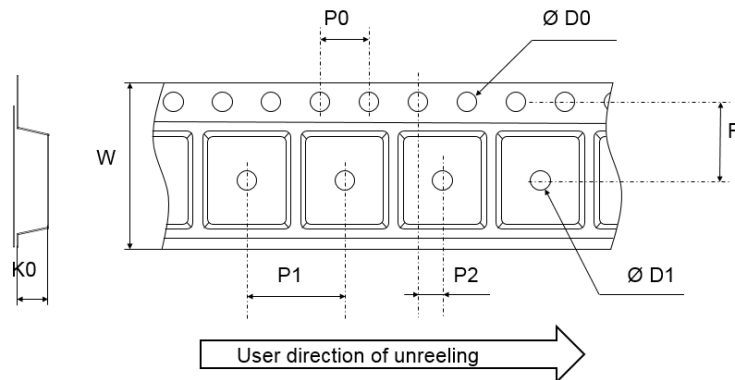

Figure 20. Tape outline



Note: Pocket dimensions are not on scale  
Pocket shape may vary depending on package

Table 4. Tape dimension values

Ref.	Dimensions		
	Millimeters		
	Min.	Typ.	Max.
D0	1.4	1.5	1.6
D1	1.5		
F	7.4	7.5	7.6
K0	2.39	2.49	2.59
P0	3.9	4.0	4.1
P1	7.9	8.0	8.1
P2	1.9	2.0	2.1
W	15.7	16	16.3



## 2.2 Reflow profile

Figure 21. ST ECOPACK recommended soldering reflow profile for PCB mounting

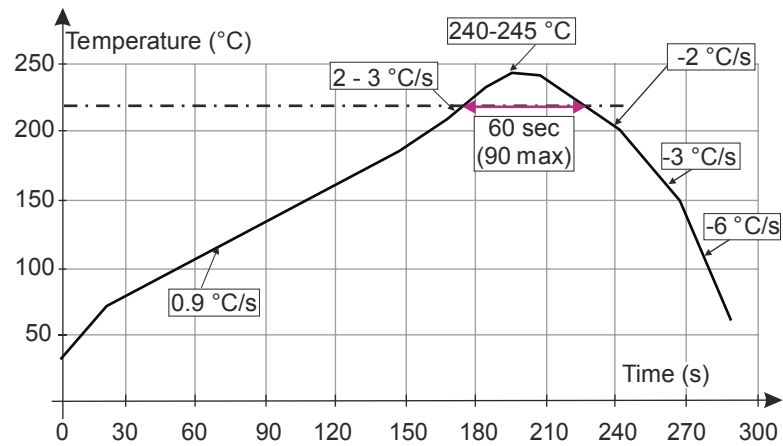

*Note:* Minimize air convection currents in the reflow oven to avoid component movement. Maximum soldering profile corresponds to the latest IPC/JEDEC J-STD-020.

### 3 Ordering information

Figure 22. Ordering information scheme

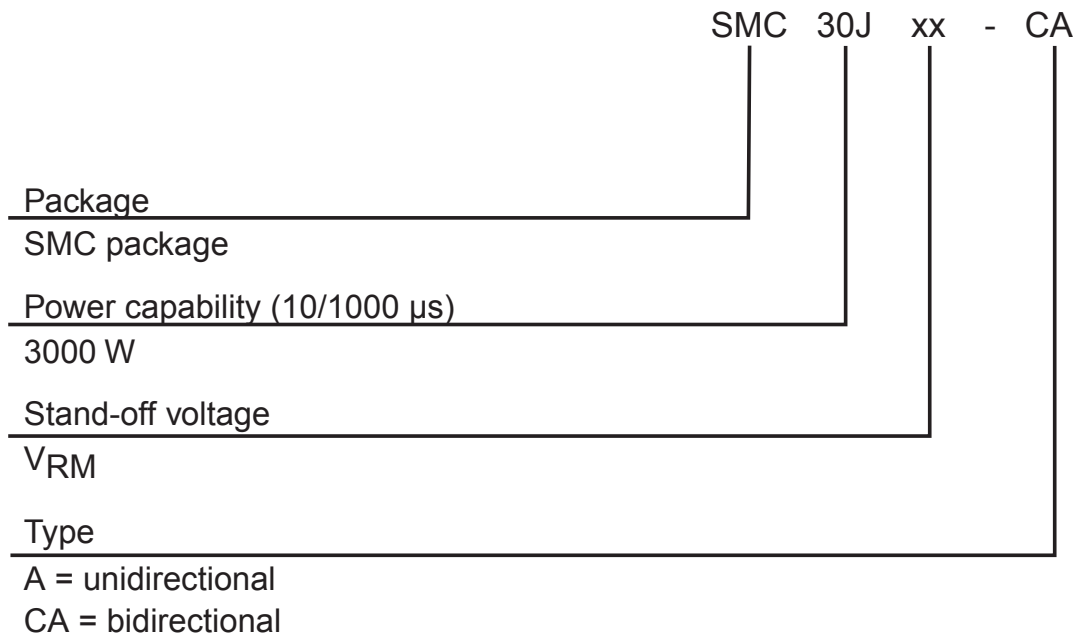

Table 5. Ordering information

Order code	Marking	Package	Weight	Base qty.	Delivery mode
SMC30JxxA/CA <sup>(1)</sup>	See Table 6. Marking	SMC	0.25 g	2500	Tape and reel

1. Where xx is  $V_{RM}$  and A or CA indicates unidirectional or bidirectional version.

**Table 6. Marking**

Order code	Marking	Order code	Marking
SMC30J5.0A	3AAA	SMC30J5.0CA	3BAA
SMC30J6.0A	3AAB	SMC30J6.0CA	3BAB
SMC30J6.5A	3AAC	SMC30J6.5CA	3BAC
SMC30J8.5A	3AAD	SMC30J8.5CA	3BAD
SMC30J10A	3AAW	SMC30J10CA	3BAW
SMC30J12A	3AAF	SMC30J12CA	3BAF
SMC30J13A	3AAG	SMC30J13CA	3BAG
SMC30J15A	3AAH	SMC30J15CA	3BAH
SMC30J16A	3AAI	SMC30J16CA	3BAI
SMC30J18A	3AAJ	SMC30J18CA	3BAJ
SMC30J20A	3AAK	SMC30J20CA	3BAK
SMC30J22A	3AAL	SMC30J22CA	3BAL
SMC30J24A	3AAE	SMC30J24CA	3BAE
SMC30J26A	3AAM	SMC30J26CA	3BAM
SMC30J28A	3AAN	SMC30J28CA	3BAN
SMC30J30A	3AAO	SMC30J30CA	3BAO
SMC30J33A	3AAP	SMC30J33CA	3BAP
SMC30J36A	3AAQ	SMC30J36CA	3BAQ
SMC30J40A	3AAR	SMC30J40CA	3BAR
SMC30J48A	3AAS	SMC30J48CA	3BAS
SMC30J58A	3ACY	SMC30J58CA	3BCY
SMC30J64A	3ADE	SMC30J64CA	3BDE
SMC30J70A	3ADK	SMC30J70CA	3BDK
SMC30J85A	3ADZ	SMC30J85CA	3BDZ
SMC30J100A	3AEO	SMC30J100CA	3BEO
SMC30J130A	3AFS	SMC30J130CA	3BFS
SMC30J154A	3AGQ	SMC30J154CA	3BGQ
SMC30J170A	3AHG	SMC30J170CA	3BHG
SMC30J188A	3AHY	SMC30J188CA	3BHY

## Revision history

**Table 7. Document revision history**

Date	Version	Changes
28-Jul-2011	1	Initial release.
15-Jul-2015	2	Updated features on cover page. Updated Table 1, Figure 3, Figure 5, Figure 6, Figure 7, Figure 8, Figure 10 and Figure 11. Updated Table 5.
22-Jul-2015	3	Updated Figure 9.
12-Nov-2019	4	Updated front page, Table 2. Electrical characteristics - parameter values ( $T_{amb} = 25\text{ °C}$ , unless otherwise specified) and Section 1.1 Characteristics (curves).
10-Mar-2020	5	Updated Table 2. Electrical characteristics - parameter values ( $T_{amb} = 25\text{ °C}$ , unless otherwise specified).
25-Oct-2021	6	Updated Figure 11.
31-Jan-2022	7	Range extension up to 188 V.

**IMPORTANT NOTICE – PLEASE READ CAREFULLY**

STMicroelectronics NV and its subsidiaries (“ST”) reserve the right to make changes, corrections, enhancements, modifications, and improvements to ST products and/or to this document at any time without notice. Purchasers should obtain the latest relevant information on ST products before placing orders. ST products are sold pursuant to ST’s terms and conditions of sale in place at the time of order acknowledgement.

Purchasers are solely responsible for the choice, selection, and use of ST products and ST assumes no liability for application assistance or the design of Purchasers’ products.

No license, express or implied, to any intellectual property right is granted by ST herein.

Resale of ST products with provisions different from the information set forth herein shall void any warranty granted by ST for such product.

ST and the ST logo are trademarks of ST. For additional information about ST trademarks, please refer to [www.st.com/trademarks](http://www.st.com/trademarks). All other product or service names are the property of their respective owners.

Information in this document supersedes and replaces information previously supplied in any prior versions of this document.

© 2022 STMicroelectronics – All rights reserved