

**MATERIALS AND FINISH:**

SHELL: STEEL MATERIAL, NICKEL FINISH  
 INSULATOR: PA9T or PA6T, UL 94V-0 RATED, BLACK (PROCESS TEMP 260°C)  
 CONTACT MATERIAL: BRASS  
 CONTACT FINISH: SEE P/N KEY BELOW

**ELECTRICAL:**

CONTACT CURRENT RATING: 3 AMPS  
 CONTACT RESISTANCE: 10 mOHMS Max.  
 DIELECTRIC WITHSTANDING VOLTAGE: 1,000VAC Min.  
 INSULATION RESISTANCE: 5 GOHMS Min.  
 TEMPERATURE RATING: -55° ~ +125° C

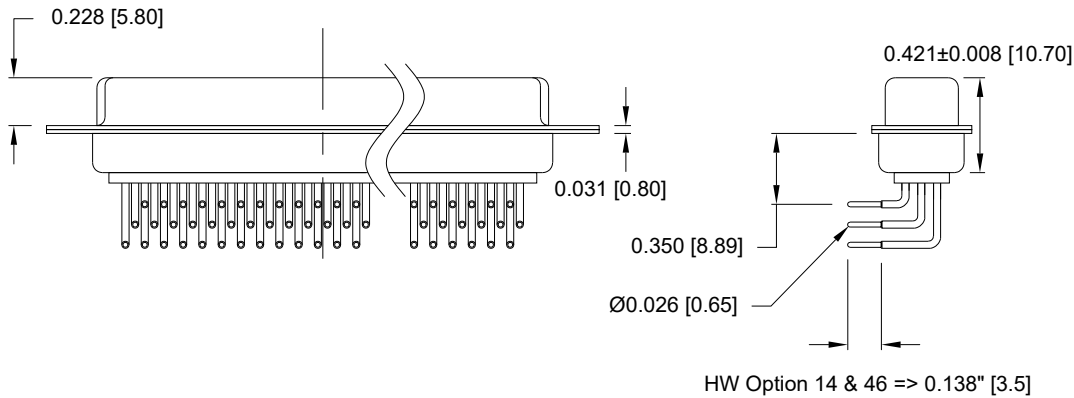
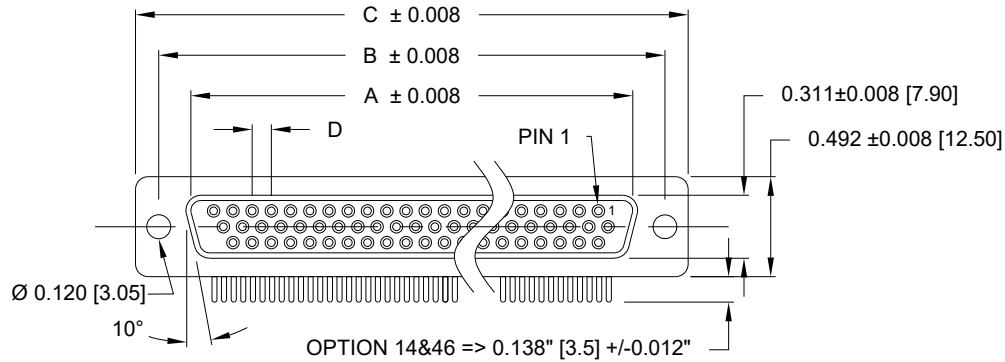

DIMENSIONS (in.)					
No. OF PINS	A	B	C	D	Insulator Material
15	0.642	0.984	1.213	0.090	PA9T
26	0.968	1.311	1.543	0.090	PA9T
44	1.512	1.852	2.089	0.090	PA9T
62	2.157	2.500	2.732	0.095	PA6T

DIMENSIONS (mm)					
No. OF PINS	A	B	C	D	Insulator Material
15	16.30	25.00	30.80	2.29	PA9T
26	24.60	33.30	39.20	2.29	PA9T
44	38.40	47.05	53.05	2.29	PA9T
62	54.80	63.50	69.40	2.41	PA6T

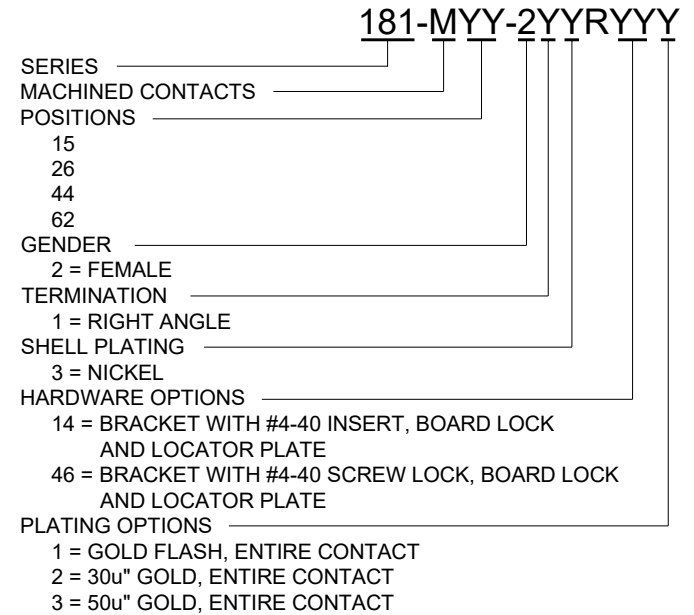

RoHS COMPLIANT

UNITS = inches [mm] DO NOT SCALE FROM DRAWING



THESE DRAWINGS AND SPECIFICATIONS ARE THE PROPERTY OF NorComp AND SHALL NOT BE REPRODUCED, COPIED OR USED AS THE BASIS FOR THE MANUFACTURE OR SALE OF APPARATUS WITHOUT WRITTEN PERMISSION.

DRAWN: C. SMITH  
 DATE: 03/19/2007

NorComp

SCALE: NTS	SHEET 1 OF 4	REV 24
DWG NO. 181-MYY-2YYRYYY		

MATERIAL: COLD ROLLED STEEL

PLATING: CLEAR ZINC

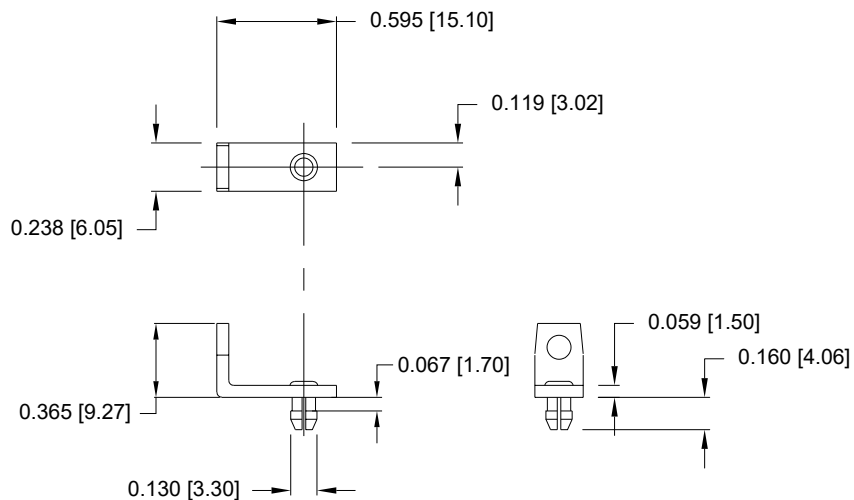

**MOUNTING BRACKET  
WITH BOARD LOCK**  
HARDWARE OPTIONS 14 & 46

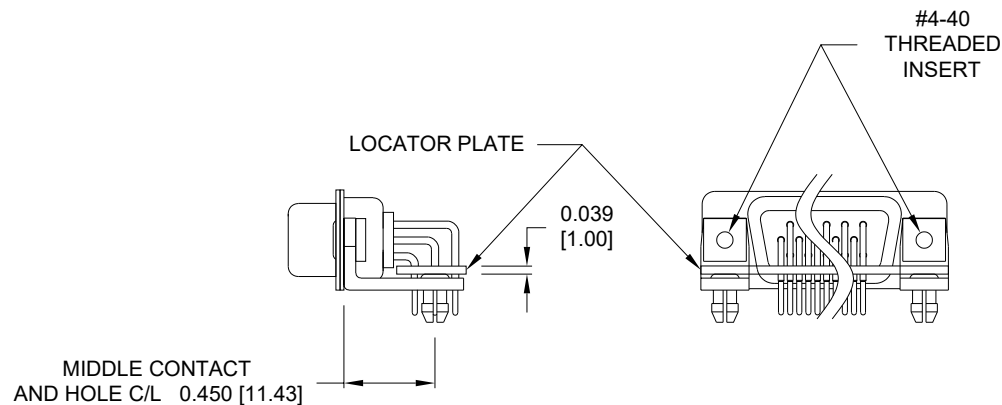

HARDWARE OPTIONS 14

**BRACKETS MOUNTED ON CONNECTOR  
WITH LOCATOR PLATE**

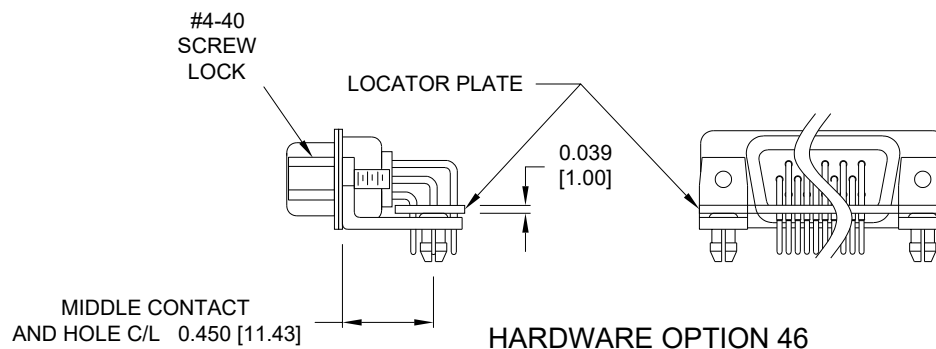

HARDWARE OPTION 46

RoHS COMPLIANT

UNITS = inches [mm]

DO NOT SCALE FROM DRAWING



THESE DRAWINGS AND SPECIFICATIONS ARE THE PROPERTY OF NorComp AND SHALL NOT BE REPRODUCED, COPIED OR USED AS THE BASIS FOR THE MANUFACTURE OR SALE OF APPARATUS WITHOUT WRITTEN PERMISSION.

DRAWN:

C. SMITH

DATE:

03/19/2007

**NorComp**

SCALE:

NTS

SHEET

2 OF 4

REV

24

DWG NO.

181-MYY-2YYRYYY

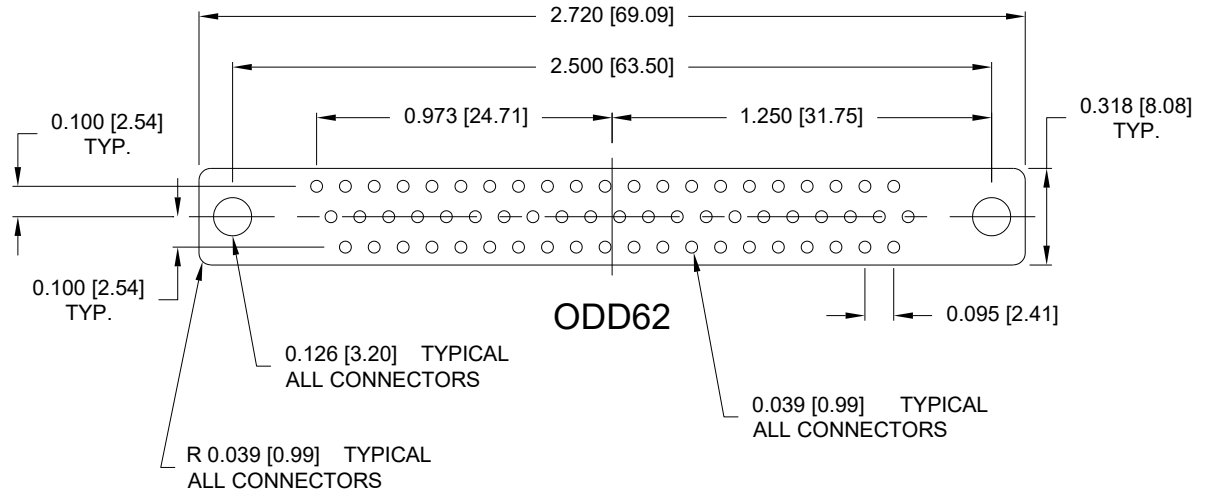
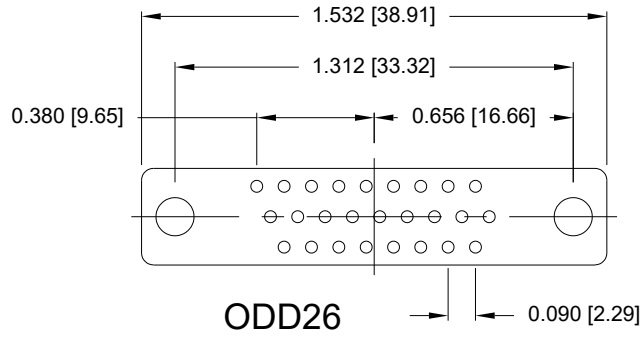
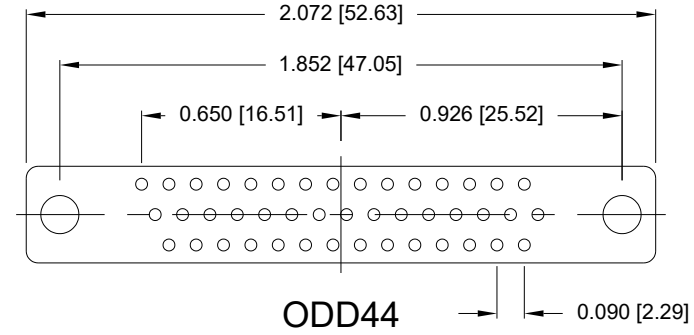
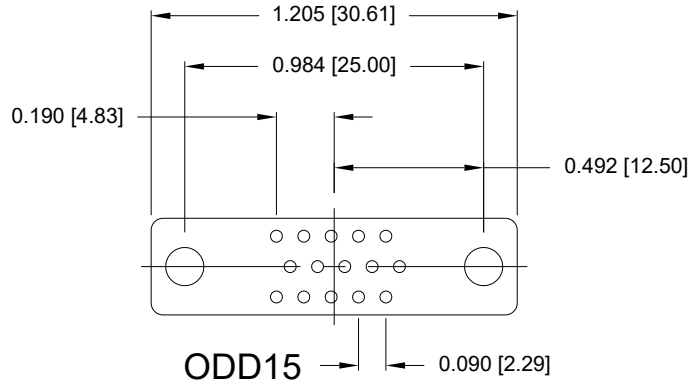

RoHS COMPLIANT

UNITS = inches [mm] DO NOT SCALE FROM DRAWING



THESE DRAWINGS AND SPECIFICATIONS ARE THE PROPERTY OF NorComp AND SHALL NOT BE REPRODUCED, COPIED OR USED AS THE BASIS FOR THE MANUFACTURE OR SALE OF APPARATUS WITHOUT WRITTEN PERMISSION.

DRAWN:  
C. SMITH

DATE:  
03/19/2007

NorComp

SCALE:  
NTS

SHEET 3 OF 4

REV 24

DWG NO.

181-MYY-2YYRYYY

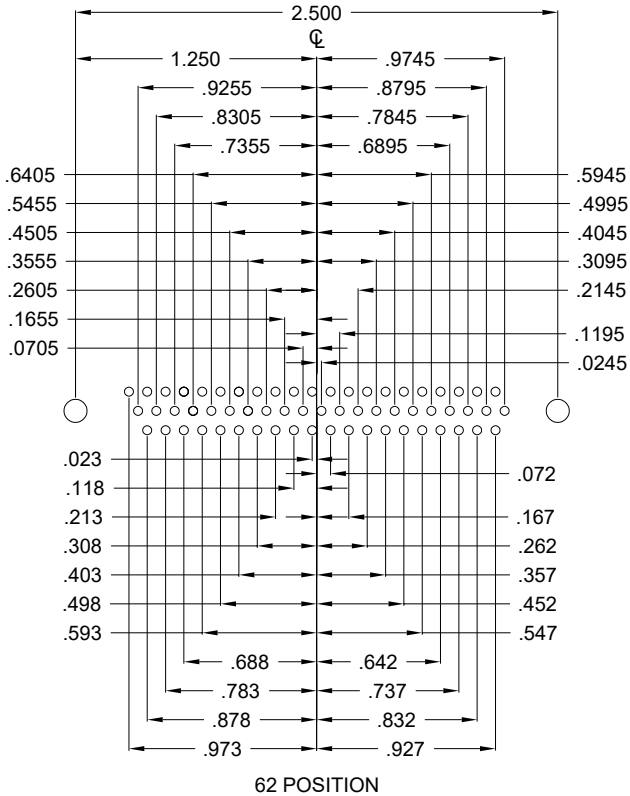
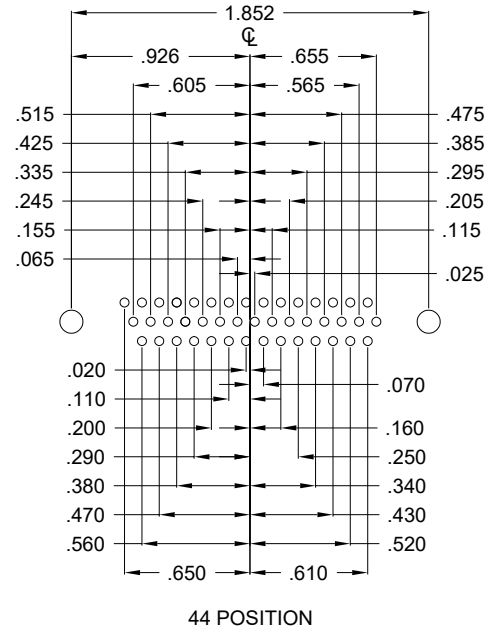
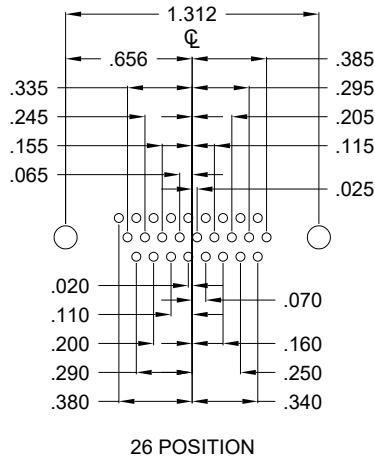
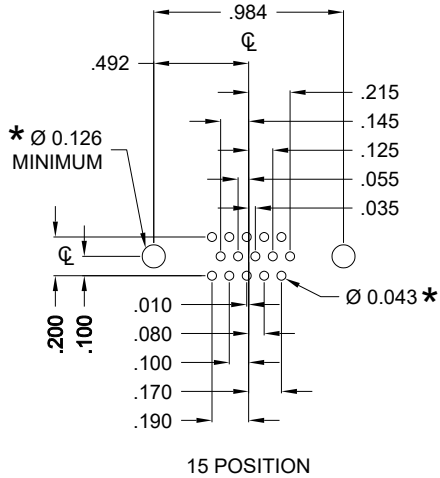

HOLE PATTERN SHOWN ARE FOR FEMALE

\* TYP. SUGGESTED SIZE MAY NOT BE SUITABLE FOR ALL APPLICATIONS

RoHS COMPLIANT

UNITS = inches

DO NOT SCALE FROM DRAWING



THESE DRAWINGS AND SPECIFICATIONS ARE THE PROPERTY OF NorComp AND SHALL NOT BE REPRODUCED, COPIED OR USED AS THE BASIS FOR THE MANUFACTURE OR SALE OF APPARATUS WITHOUT WRITTEN PERMISSION.

DRAWN: C. SMITH  
DATE: 03/19/2007

NorComp

SCALE: NTS	SHEET 4 OF 4	REV 24
DWG NO. 181-MYY-2YYRYYY		