

QUICK START GUIDE FOR DEMONSTRATION CIRCUIT 1118A-A POLYPHASE HIGH DENSITY POWER MODULE

LTM4601EV

DESCRIPTION

Demonstration circuit 1118A-A features the LTM[®]4601EV, the high efficiency, high density switch mode step-down power modules. The input voltage range is from 5V to 20V. The output voltages are 3.3V and 2.5V; refer to step down ratio curve in the LTM4601 datasheet. The rated load currents are 10 A for 3.3V output and 12A for 2.5V output, while derating is necessary for certain V_{IN} and thermal conditions. The output of U2 is set to coincidentally track with the 3.3V output. Margining function is provided for the user who wants to stress their system by

varying supply voltages during testing; refer to data-sheet for functional diagram. The DC1118A-A has onboard 180 degree interleaving clock generator at 750 KHz. Integrated input and output filters enable a simple PCB layout. Only bulk input and output capacitors are needed.

Design files for this circuit board are available. Call the LTC Factory.

 , LTC, LT and LTM are registered trademarks of Linear Technology Corporation.

Table 1. Performance Summary ($T_A = 25^\circ\text{C}$)

PARAMETER	CONDITION	VALUE
Minimum Input Voltage		5V
Maximum Input Voltage		20V
Output Voltage V_{OUT1}	$V_{IN} = 5$ to 20V, $I_{OUT} = 0$ to 10A	$3.3V \pm 2\%$
Output Voltage V_{OUT2}	$V_{IN} = 5$ to 20V, $I_{OUT} = 0$ to 12A	$2.5V \pm 2\%$
Default Operating Frequency		750kHz
Load Transient	$V_{IN} = 12V$, $V_{OUT} = 3.3V$	See Figure 3 and Table 1 for details
	$V_{IN} = 12V$, $V_{OUT} = 2.5V$	See Figure 4 and Table 1 for details

QUICK START PROCEDURE

Demonstration circuit 1118A-A is easy to set up to evaluate the performance of the LTM4601EV. Please refer to Figure 1 for proper measurement equipment setup and follow the procedure below:

1. Place jumpers in the following positions for a typical application:

RUN	U1 & U2 MARG0	U1 & U2 MARG1
ON	LO	LO

2. With power off, connect the input power supply, load, and meters as shown in Figure 1. Preset

the load to 0A and V_{IN} supply to be less than 20V.

3. Turn on the power at the input. The output voltage of U1 should be $3.3V \pm 2\%$, while the output voltage of U2 should $2.5V \pm 2\%$.
4. Once the proper output voltage is established, adjust the load within the operating range and observe the output voltage regulation, ripple voltage, efficiency and other parameters. When measuring the input or output voltage ripple, care must be taken to avoid a long ground lead on the oscilloscope probe. Measure the input or output voltage ripple by touching the probe tip directly across the V_{IN} or V_{OUT} capacitors. See Figure 2 for proper scope probe technique.

QUICK START GUIDE FOR DEMONSTRATION CIRCUIT 1118A-A POLYPHASE HIGH DENSITY POWER MODULE

- For tracking function test, shut down the power supply, discharge the output capacitors until outputs read 0V. Use single trigger of the oscilloscope to capture the input waveform and output waveforms of U1 and U2.
- For Margining function test, place jumper MARG0 and MARG1 in the configurations shown

in the following table, measure the output voltage at Vo+ and Vo-.

MARG1	MARG0	Vout
LO	LO	0
LO	HI	+5%
HI	LO	-5%
HI	HI	0

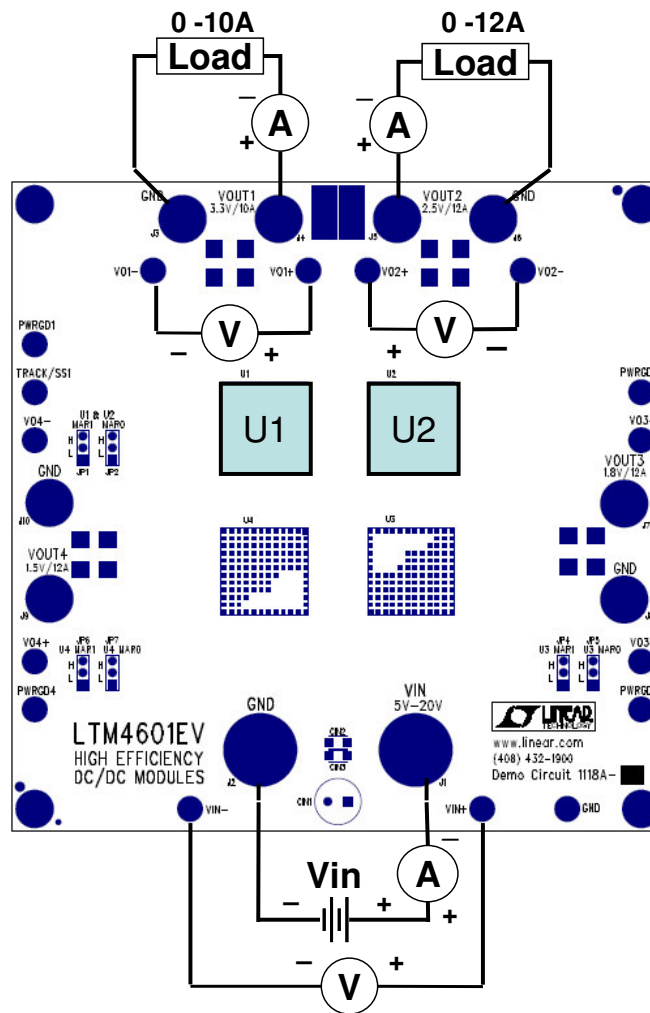
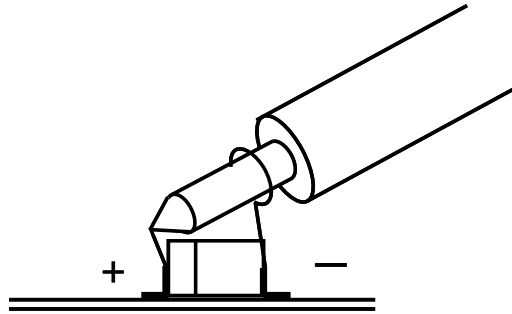

Figure 1. Proper Measurement Equipment Setup

QUICK START GUIDE FOR DEMONSTRATION CIRCUIT 1118A-A POLYPHASE HIGH DENSITY POWER MODULE



Input or Output Capacitor

Figure 2. Scope Probe Placements for Measuring Input or Output Ripple on capacitors.

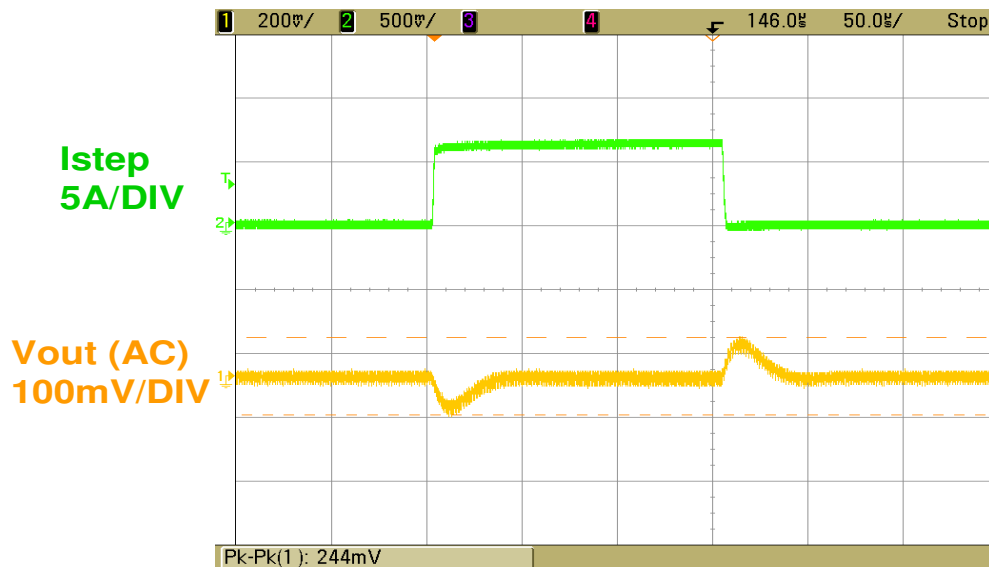

$V_{in} = 12V$

$V_{out} = 3.3V$

$C_{out} = 2 \times 22\mu F$ ceramic (1206), $2 \times 100\mu F$ ceramic (1812), $C_{12} = 47pF$

Figure 3. Measured Load Transient Response (3-9A Step) of 3.3V output.

QUICK START GUIDE FOR DEMONSTRATION CIRCUIT 1118A-A POLYPHASE HIGH DENSITY POWER MODULE

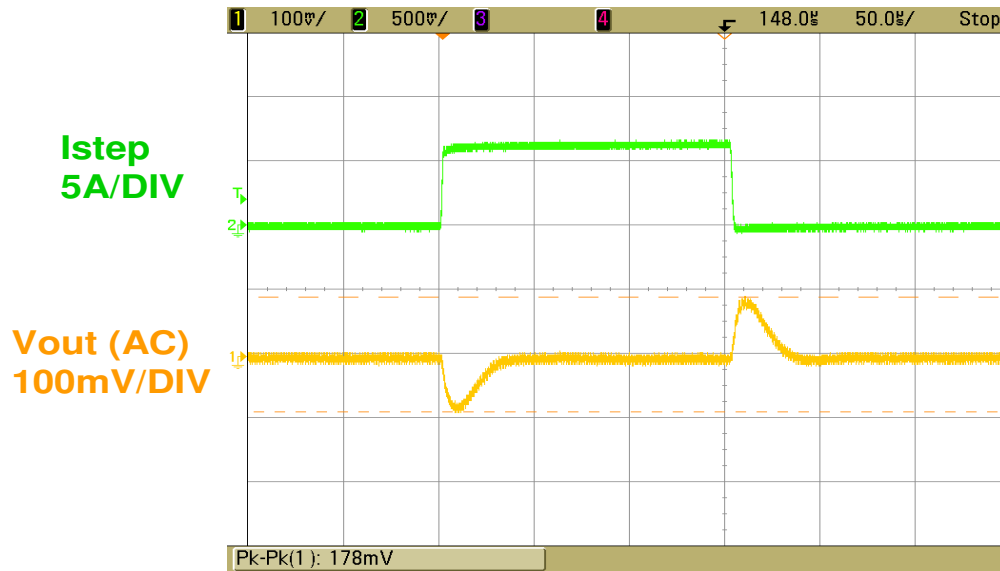

$V_{in} = 12V$

$V_{out} = 2.5V$

$C_{out} = 2 \times 22\mu F$ ceramic (1206), $2 \times 100\mu F$ ceramic (1812), $C52 = 47pF$

Figure 4. Measured Load Transient Response (3-9A Step) of 2.5V output.

QUICK START GUIDE FOR DEMONSTRATION CIRCUIT 1118A-A POLYPHASE HIGH DENSITY POWER MODULE

Table1. Output Capacitor vs, Load Transient (3-9A Step)

TYPICAL MEASURED VALUES												
Cout1 VENDORS		PART NUMBER				Cout2 VENDORS		PART NUMBER				
TDK		C4532X5R0J107MZ (100UF, 6.3V)				SANYO POS CAP		6TPE330ML (330UF, 6.3V)				
TAIYO YUDEN		JMK432BJ107MU-T (100UF, 6.3V)				SANYO POS CAP		2R5TPE470M9 (470UF, 2.5V)				
TAIYO YUDEN		JMK316BJ226ML-T501 (22UF, 6.3V)				SANYO POS CAP		4TPE470MCL (470UF, 4V)				
Vout (V)	Cin (ceramic)	Cin (bulk)	Cout1 (Ceramic)	Cout2 (Bulk)	Ccomp	CFF	Vin (V)	Droop (mV)	Pk to Pk (mV)	Recovery time (uS)	Load Step (A/uS)	Rset (kOhm)
1.2	2 x 10uF 25V	150uF 35V	3 x 22uF	470uF 4V	NONE	100pF	5	50	109	18	6	60.4
1.2	2 x 10uF 25V	150uF 35V	1 x 100uF	470uF 2.5V	NONE	100pF	5	50	97	20	6	60.4
1.2	2 x 10uF 25V	150uF 35V	2 x 100uF	330uF 6.3V	NONE	100pF	5	65	113	10	6	60.4
1.2	2 x 10uF 25V	150uF 35V	4 x 100uF	NONE	NONE	100pF	5	50	95	10	6	60.4
1.2	2 x 10uF 25V	150uF 35V	3 x 22uF	470uF 4V	NONE	100pF	12	50	109	18	6	60.4
1.2	2 x 10uF 25V	150uF 35V	1 x 100uF	470uF 2.5V	NONE	100pF	12	50	97	20	6	60.4
1.2	2 x 10uF 25V	150uF 35V	2 x 100uF	330uF 6.3V	NONE	100pF	12	65	113	13	6	60.4
1.2	2 x 10uF 25V	150uF 35V	4 x 100uF	NONE	NONE	100pF	12	55	97	15	6	60.4
1.5	2 x 10uF 25V	150uF 35V	3 x 22uF	470uF 4V	NONE	100pF	5	55	116	20	6	40.2
1.5	2 x 10uF 25V	150uF 35V	1 x 100uF	470uF 2.5V	NONE	100pF	5	55	97	23	6	40.2
1.5	2 x 10uF 25V	150uF 35V	2 x 100uF	330uF 6.3V	NONE	100pF	5	65	122	13	6	40.2
1.5	2 x 10uF 25V	150uF 35V	4 x 100uF	NONE	NONE	100pF	5	57	100	18	6	40.2
1.5	2 x 10uF 25V	150uF 35V	3 x 22uF	470uF 4V	NONE	100pF	12	55	116	20	6	40.2
1.5	2 x 10uF 25V	150uF 35V	1 x 100uF	470uF 2.5V	NONE	100pF	12	58	100	23	6	40.2
1.5	2 x 10uF 25V	150uF 35V	2 x 100uF	330uF 6.3V	NONE	100pF	12	70	122	15	6	40.2
1.5	2 x 10uF 25V	150uF 35V	4 x 100uF	NONE	NONE	100pF	12	61	105	18	6	40.2
1.8	2 x 10uF 25V	150uF 35V	3 x 22uF	470uF 4V	NONE	100pF	5	60	120	20	6	30.1
1.8	2 x 10uF 25V	150uF 35V	1 x 100uF	470uF 2.5V	NONE	100pF	5	65	106	24	6	30.1
1.8	2 x 10uF 25V	150uF 35V	2 x 100uF	330uF 6.3V	NONE	100pF	5	80	134	20	6	30.1
1.8	2 x 10uF 25V	150uF 35V	4 x 100uF	NONE	NONE	100pF	5	63	109	18	6	30.1
1.8	2 x 10uF 25V	150uF 35V	3 x 22uF	470uF 4V	NONE	100pF	12	60	122	20	6	30.1
1.8	2 x 10uF 25V	150uF 35V	1 x 100uF	470uF 2.5V	NONE	100pF	12	70	106	28	6	30.1
1.8	2 x 10uF 25V	150uF 35V	2 x 100uF	330uF 6.3V	NONE	100pF	12	85	134	20	6	30.1
1.8	2 x 10uF 25V	150uF 35V	4 x 100uF	NONE	NONE	100pF	12	68	114	21	6	30.1
2.5	2 x 10uF 25V	150uF 35V	1 x 100uF	470uF 4V	NONE	100pF	5	80	131	30	6	19.1
2.5	2 x 10uF 25V	150uF 35V	2 x 100uF	330uF 6.3V	NONE	100pF	5	95	159	20	6	19.1
2.5	2 x 10uF 25V	150uF 35V	3 x 22uF	470uF 4V	NONE	100pF	5	75	134	25	6	19.1
2.5	2 x 10uF 25V	150uF 35V	4 x 100uF	NONE	NONE	100pF	5	75	134	23	6	19.1
2.5	2 x 10uF 25V	150uF 35V	1 x 100uF	470uF 4V	NONE	100pF	12	85	131	30	6	19.1
2.5	2 x 10uF 25V	150uF 35V	3 x 22uF	470uF 4V	NONE	100pF	12	75	138	25	6	19.1
2.5	2 x 10uF 25V	150uF 35V	2 x 100uF	330uF 6.3V	NONE	100pF	12	100	159	22	6	19.1
2.5	2 x 10uF 25V	150uF 35V	4 x 100uF	NONE	NONE	100pF	12	80	134	23	6	19.1
3.3	2 x 10uF 25V	150uF 35V	2 x 100uF	330uF 6.3V	NONE	100pF	7	115	188	35	6	13.3
3.3	2 x 10uF 25V	150uF 35V	1 x 100uF	470uF 4V	NONE	100pF	7	88	147	30	6	13.3
3.3	2 x 10uF 25V	150uF 35V	3 x 22uF	470uF 4V	NONE	100pF	7	85	159	30	6	13.3
3.3	2 x 10uF 25V	150uF 35V	4 x 100uF	NONE	NONE	100pF	7	89	161	24	6	13.3
3.3	2 x 10uF 25V	150uF 35V	1 x 100uF	470uF 4V	NONE	100pF	12	100	156	30	6	13.3
3.3	2 x 10uF 25V	150uF 35V	3 x 22uF	470uF 4V	NONE	100pF	12	90	159	30	6	13.3
3.3	2 x 10uF 25V	150uF 35V	2 x 100uF	330uF 6.3V	NONE	100pF	12	120	188	39	6	13.3
3.3	2 x 10uF 25V	150uF 35V	4 x 100uF	NONE	NONE	100pF	12	89	169	24	6	13.3
5	2 x 10uF 25V	150uF 35V	4 x 100uF	NONE	NONE	100pF	15	140	253	25	6	8.25
5	2 x 10uF 25V	150uF 35V	4 x 100uF	NONE	NONE	100pF	20	145	159	25	6	8.25

LTM4601 module has similar load transient response at 12Vin and 20Vin

QUICK START GUIDE FOR DEMONSTRATION CIRCUIT 1118A-A POLYPHASE HIGH DENSITY POWER MODULE

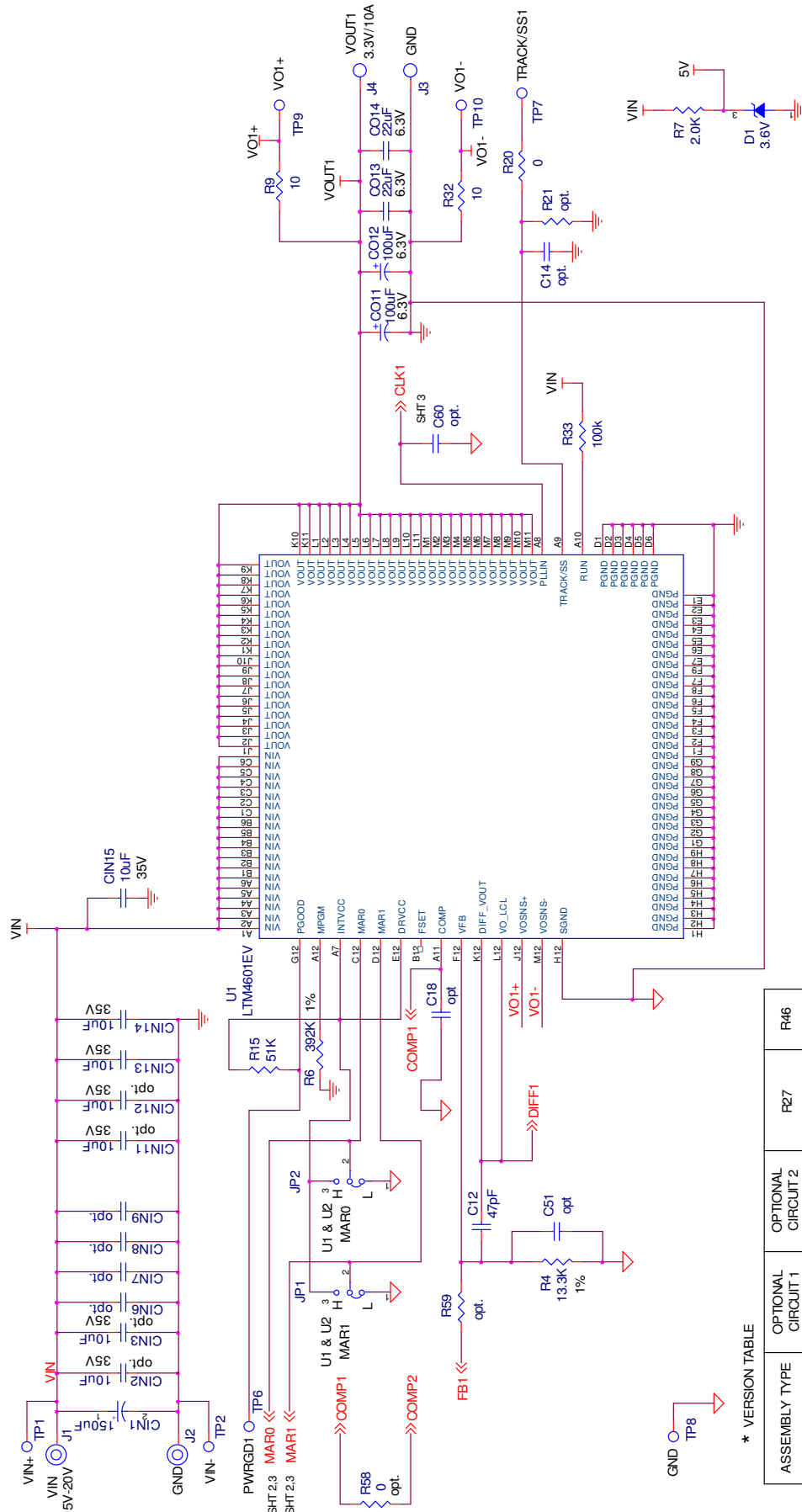

* VERSION TABLE

ASSEMBLY TYPE	OPTIONAL CIRCUIT 1	OPTIONAL CIRCUIT 2	R46
DC1118A-A	NOT INSTALLED	NOT INSTALLED	66.5K
DC1118A-B	INSTALLED	NOT INSTALLED	88.7K
DC1118A-C	INSTALLED	INSTALLED	66.5K

QUICK START GUIDE FOR DEMONSTRATION CIRCUIT 1118A-A POLYPHASE HIGH DENSITY POWER MODULE

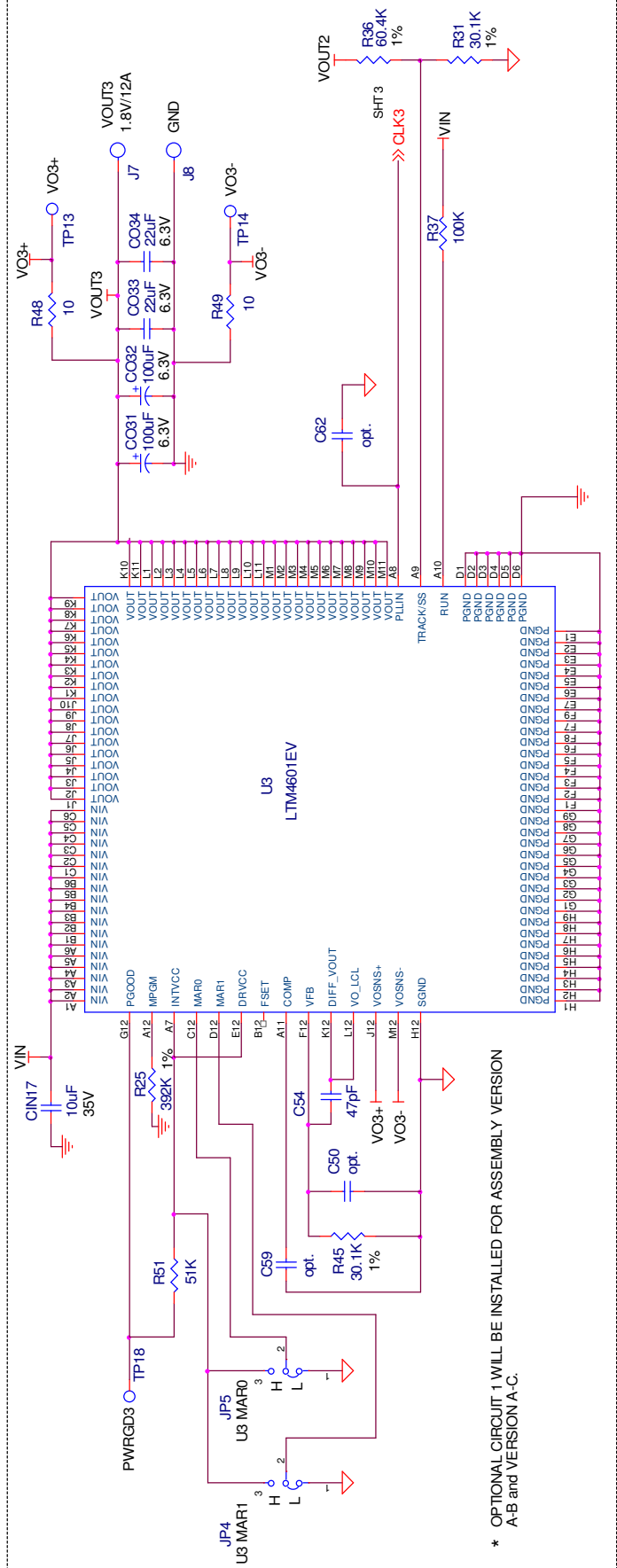
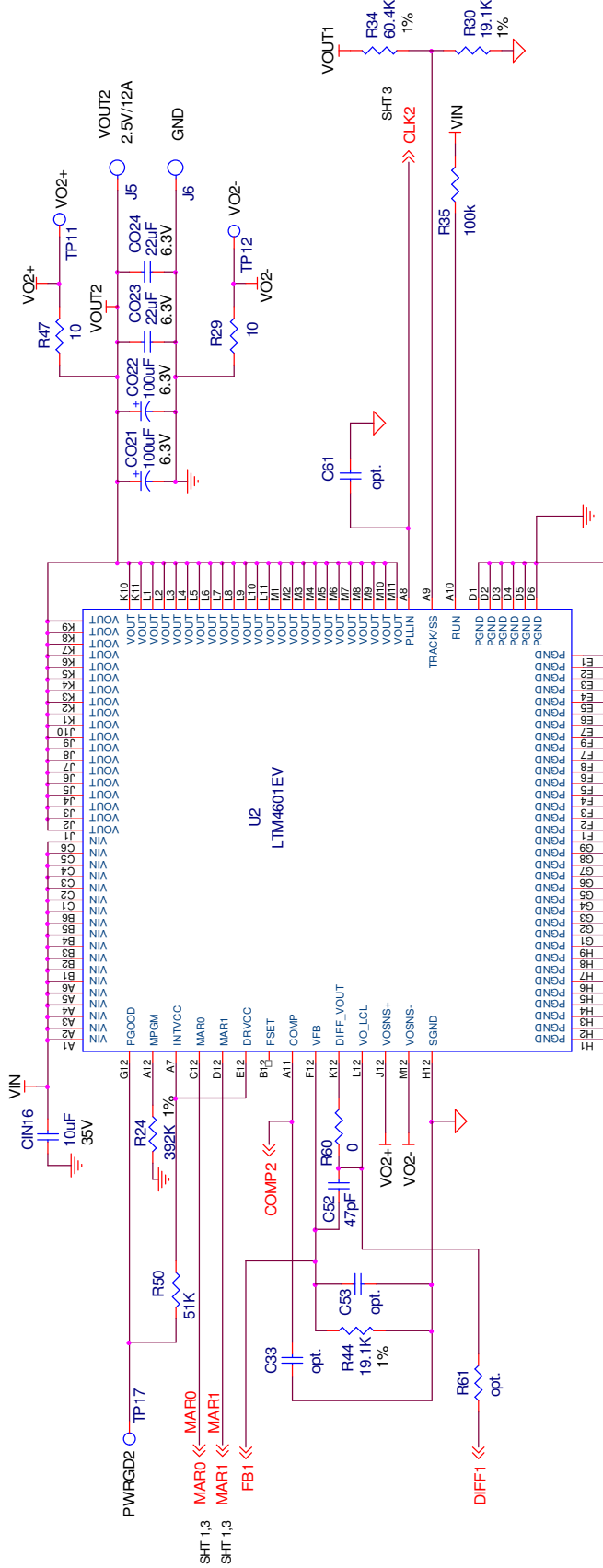

* OPTIONAL CIRCUIT 1 WILL BE INSTALLED FOR ASSEMBLY VERSION A-B and VERSION A-C.

QUICK START GUIDE FOR DEMONSTRATION CIRCUIT 1118A-A POLYPHASE HIGH DENSITY POWER MODULE

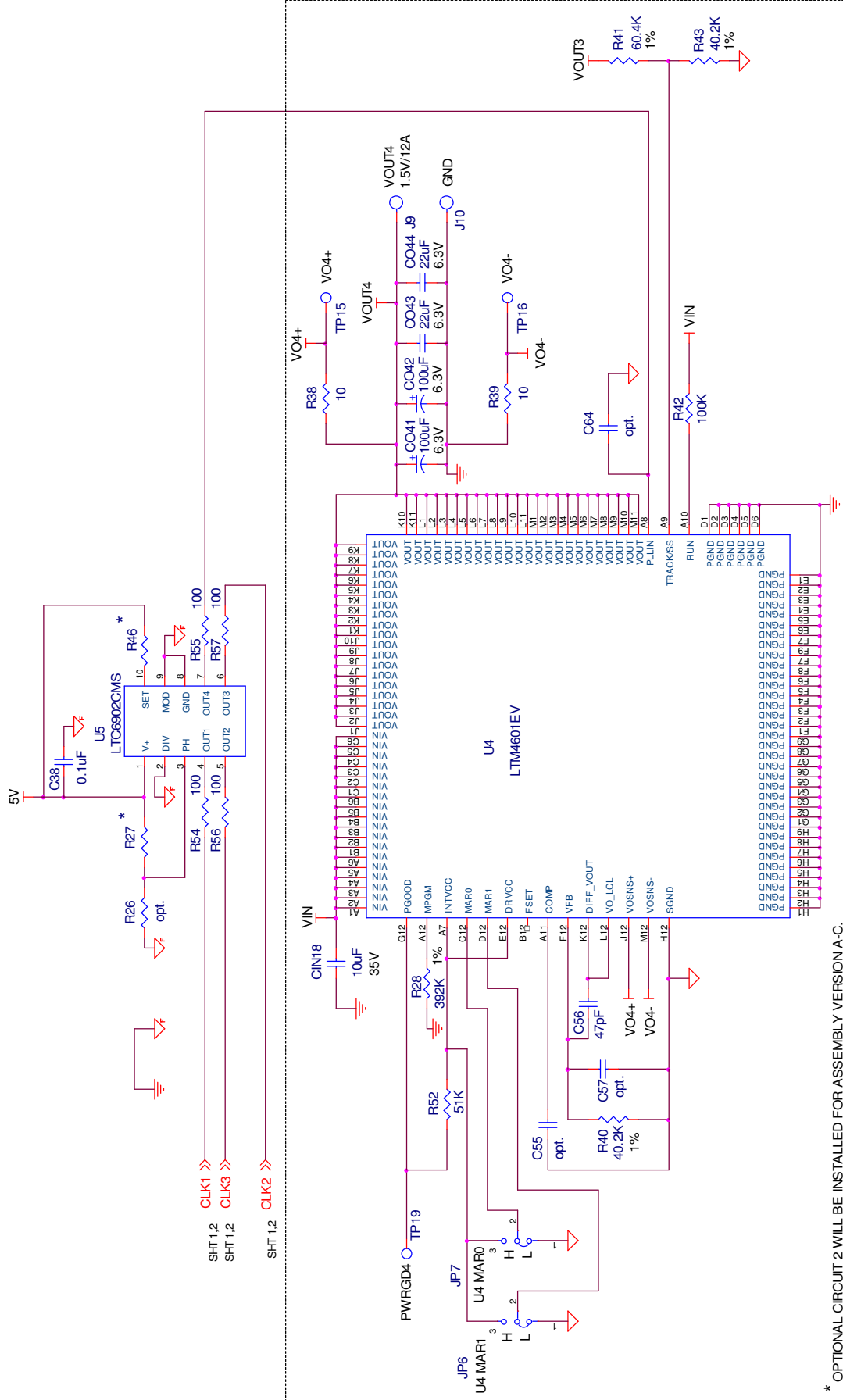

* OPTIONAL CIRCUIT 2 WILL BE INSTALLED FOR ASSEMBLY VERSION A-C.

QUICK START GUIDE FOR DEMONSTRATION CIRCUIT 1118A-A POLYPHASE HIGH DENSITY POWER MODULE

DC1118A-A BOM

Item	Qty	Reference	Part Description	Manufacturer / Part #
REQUIRED CIRCUIT COMPONENTS:				
1	1	CIN1	CAP., ALUM, 150uF 20% 35V (PBF)	SANYO 35ME150WXV+TS
2	4	CIN13,CIN14,CIN15,CIN16	CAP., X5R, 10uF, 35V, 20%, 1206	TAIYO YUDEN, GMK316BJ106ML-T
3	4	CO11,CO12,CO21,CO22	CAP., X5R, 100uF, 6.3V, 20% 1812	TDK C4532X5R0J107MZ
4	4	CO13,CO14,CO23,CO24	CAP., X5R, 22uF, 6.3V, 20% 1206	TAIYO YUDEN JMK316BJ226ML-T
5	1	C38	CAP., X7R, 0.1uF, 10V, 10%, 0603	AVX, 0603ZC104KAT2A
6	2	C12,C52	CAP., C0G, 47pF, 50V, 5%, 0603	AVX, 06035A470JAT2A
7	1	R4	RES., CHIP, 13.3K, 1/16W, 1% 0603	VISHAY, CRCW060313K3FKEA
8	2	R6,R24	RES., CHIP, 392K, 1/16W, 1% 0603	VISHAY, CRCW0603392KFKEA
9	4	R9,R29,R32,R47	RES., CHIP, 10, 1/16W, 0603	VISHAY, CRCW060310R0JNEA
10	1	R44	RES., CHIP, 19.1K, 1/16W, 1% 0603	VISHAY, CRCW060319K1FKEA
11	2	R33,R35	RES., CHIP, 100K, 1/16W, 5% 0603	VISHAY, CRCW0603100KJNEA
12	1	R46	RES., CHIP, 66.5K, 1/16W, 1% 0603	VISHAY, CRCW060366K5FKEA
13	4	R54,R55,R56,R57	RES., CHIP, 100, 1/16W, 5% 0603	VISHAY, CRCW0603100RJNEA
14	2	U1,U2	IC, LTM4601EV 15mm x15mm LGA	LINEAR TECH. LTM4601EV#PBF
15	1	U5	I.C, LTC6902CMS MSOP10	LINEAR TECH., LTC6902CMS
ADDITIONAL DEMO BOARD CIRCUIT COMPONENTS:				
1	0	CIN2,CIN3,CIN6,CIN7,CIN8, CIN9,CIN11,CIN12 (opt.)	CAP., 1206	
2	0	C14,C18,C33,C51,C53,C60,C61 (opt.)	CAP., 0603	
3	1	D1	DIODE, 3.6V SOT23	DIODES INC., MMBZ5227B
4	1	R7	RES., CHIP, 2.0K, 1/8W, 5% 0805	VISHAY, CRCW08052K00JNEA
5	2	R15,R50	RES., CHIP, 51K, 1/16W, 5% 0603	VISHAY, CRCW060351K0JNEA
6	0	R21,R26,R58,R59,R61 (opt.)	RES., 0603	
7	2	R20,R60	RES., CHIP, 0, 1/16W, 5% 0603	VISHAY, CRCW06030000Z0EA
8	1	R27	RES., CHIP, 0, 1/16W, 0603	VISHAY, CRCW06030000Z0EA
9	1	R30	RES., CHIP, 19.1K, 1/16W, 1% 0603	VISHAY, CRCW060319K1FKEA
10	1	R34	RES., CHIP, 60.4K, 1/16W, 1% 0603	VISHAY, CRCW060360K4FKEA
HARDWARE-FOR DEMO BOARD ONLY:				
1	6	JP1,JP2,JP4-JP7	HEADER 3 PIN 0.079 SINGLE ROW	SAMTEC, TMM103-02-L-S
2	6	XJP1,XJP2,XJP4-XJP7	SHUNT, .079" CENTER	SAMTEC, 2SN-BK-G
3	2	J1,J2	STUD	PEM, KFH-032-10
4	4	J1,J2(2 EACH)	NUT, BRASS, #10-32	ANY
5	2	J1,J2	Ring, Lug Ring # 10	KEYSTONE 8205
6	2	J1,J2	WASHER, STAR #10 BRASS NICHEL	ANY
7	8	J3-J10	JACK BANANA	KEYSTONE, 575-4
8	16	TP1,TP2,TP6-TP19	TESTPOINT, TURRET, .094" pbf	MILL-MAX, 2501-2-00-80-00-00-07-0
9	4	(STAND-OFF)	STAND-OFF, NYLON 0.50"	KEYSTONE, 8833(SNAP ON)
OPTIONAL CIRCUIT 1 & 2 COMPONENTS (NOT INSTALL FOR A-A)				
1	2	CIN17,CIN18	CAP., X5R, 10uF, 35V, 20%, 1206	TAIYO YUDEN, GMK316BJ106ML-T
2	4	CO31,CO32,CO41,CO42	CAP., X5R, 100uF, 6.3V, 20% 1812	TDK C4532X5R0J107MZ
3	4	CO33,CO34,CO43,CO44	CAP., X5R, 22uF, 6.3V, 20% 1206	TAIYO YUDEN JMK316BJ226ML-T
4	0	C50,C55,C57,C59,C62,C64 (opt.)	CAP., 0603	
5	2	C54,C56,	CAP., C0G, 47pF, 50V, 5%, 0603	AVX, 06035A470JAT2A
6	2	R25,R28	RES., CHIP, 392K, 1/16W, 1% 0603	VISHAY, CRCW0603392KFKEA
7	2	R38,R39	RES., CHIP, 0, 1/16W, 0603	VISHAY, CRCW06030000Z0EA
8	2	R48,R49	RES., CHIP, 10, 1/16W, 0603	VISHAY, CRCW060310R0JNEA
9	2	R51,R52	RES., CHIP, 51K, 1/16W, 5% 0603	VISHAY, CRCW060351K0JNEA
10	2	R31,R45	RES., CHIP, 30.1K, 1/16W, 1% 0603	VISHAY, CRCW060330K1FKEA
11	2	R40,R43	RES., CHIP, 40.2K, 1/16W, 1% 0603	VISHAY, CRCW060340K2FKEA
12	2	R36,R41	RES., CHIP, 60.4K, 1/16W, 1% 0603	VISHAY, CRCW060360K4FKEA
13	2	R37,R42	RES., CHIP, 100K, 1/16W, 5% 0603	VISHAY, CRCW0603100KJNEA
14	2	U3,U4	IC, LTM4601EV 15mm x15mm LGA	LINEAR TECH. LTM4601EV#PBF