

# Trench Gate Power MOSFET

IXTA76N25T IXTH76N25T  
IXTI76N25T IXTP76N25T  
IXTQ76N25T

$V_{DSS} = 250V$   
 $I_{D25} = 76A$   
 $R_{DS(on)} \leq 39m\Omega$

N-Channel Enhancement Mode

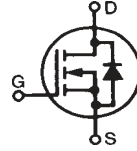

Typical avalanche BV = 300V

TO-263 (IXTA)

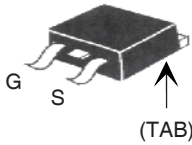

TO-247 (IXTH)

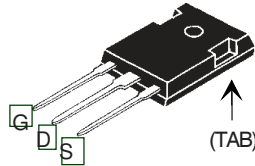

TO-262 (IXTI)

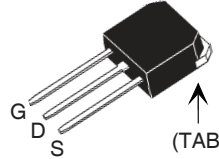

TO-220 (IXTP)

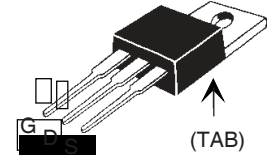

Symbol	Test Conditions	Maximum Ratings	
$V_{DSS}$	$T_J = 25^\circ C$ to $150^\circ C$	250	V
$V_{DGR}$	$T_J = 25^\circ C$ to $150^\circ C$ , $R_{GS} = 1M\Omega$	250	V
$V_{GSM}$	Transient	$\pm 30$	V
$I_{D25}$	$T_C = 25^\circ C^*$	76	A
$I_{DM}$	$T_C = 25^\circ C$ , pulse width limited by $T_{JM}$	170	A
$I_{AS}$	$T_C = 25^\circ C$	8	A
$E_{AS}$	$T_C = 25^\circ C$	1.5	J
$P_D$	$T_C = 25^\circ C$	460	W
$T_J$		-55 ... +150	$^\circ C$
$T_{JM}$		150	$^\circ C$
$T_{stg}$		-55 ... +150	$^\circ C$
$T_L$	1.6mm (0.062in.) from case for 10s	300	$^\circ C$
	Plastic body for 10seconds	260	$^\circ C$
$M_d$	Mounting Torque TO-220,TO-3P,TO247	1.13 / 10	Nm/lb.in.
$F_c$	Mounting Force TO-262,TO-263	10..65 / 2.2..14.6	N/lb.
<b>Weight</b>			
	TO-262,TO-263	2.5	g
	TO-220	3.0	g
	TO-3P	5.5	g
	TO-247	6.0	g

TO-3P (IXTQ)

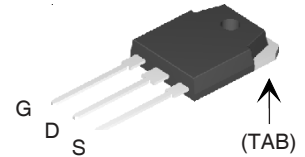

G = Gate      D = Drain  
S = Source    TAB = Drain

## Features

- International standard packages
- Avalanche rated
- Low package inductance
  - easy to drive and to protect

## Advantages

- Easy to mount
- Space savings
- High power density

## Applications

- DC-DC converters
- Battery chargers
- Switched-mode and resonant-mode power supplies
- DC choppers
- AC motor control
- Uninterruptible power supplies
- High speed power switching applications

Symbol	Test Conditions ( $T_J = 25^\circ C$ unless otherwise specified)	Characteristic Values		
		Min.	Typ.	Max.
$BV_{DSS}$	$V_{GS} = 0V, I_D = 1mA$ $V_{GS} = 0V, I_D = 10A$	250	300	V
$V_{GS(th)}$	$V_{DS} = V_{GS}, I_D = 1mA$	3		5 V
$I_{GSS}$	$V_{GS} = \pm 20V, V_{DS} = 0V$			$\pm 100$ nA
$I_{DSS}$	$V_{DS} = V_{DSS}$ $V_{GS} = 0V$ $T_J = 125^\circ C$			2 $\mu A$ 200 $\mu A$
$R_{DS(on)}$	$V_{GS} = 10V, I_D = 0.5 \cdot I_{D25}$ Note 1			39 m $\Omega$

Symbol	Test Conditions ( $T_J = 25^\circ\text{C}$ unless otherwise specified)	Characteristic Values		
		Min.	Typ.	Max.
$g_{fs}$	$V_{DS} = 10\text{V}, I_D = 0.5 \cdot I_{D25}$ , Note 1	43	72	S
$C_{iss}$	$V_{GS} = 0\text{V}, V_{DS} = 25\text{V}, f = 1\text{MHz}$		4500	pF
$C_{oss}$			480	pF
$C_{rss}$			46	pF
$t_{d(on)}$	<b>Resistive Switching Times</b> $V_{GS} = 15\text{V}, V_{DS} = 0.5 \cdot V_{DSS}, I_D = 0.5 \cdot I_{D25}$ $R_G = 3.3\Omega$ (External)		22	ns
$t_r$			25	ns
$t_{d(off)}$			56	ns
$t_f$			29	ns
$Q_{g(on)}$	$V_{GS} = 10\text{V}, V_{DS} = 0.5 \cdot V_{DSS}, I_D = 25\text{A}$		92	nC
$Q_{gs}$			28	nC
$Q_{gd}$			21	nC
$R_{thJC}$	TO-220 TO-3P, TO-247		0.50	0.27 °C/W
$R_{thCH}$				°C/W
			0.21	°C/W

**Source-Drain Diode**

Symbol	Test Conditions ( $T_J = 25^\circ\text{C}$ unless otherwise specified)	Characteristic Values		
		Min.	Typ.	Max.
$I_S$	$V_{GS} = 0\text{V}$			76 A
$I_{SM}$	Repetitive, pulse width limited by $T_{JM}$			200 A
$V_{SD}$	$I_F = I_S, V_{GS} = 0\text{V}$ , Note 1			1.5 V
$t_{rr}$	$I_F = 38\text{A}, -di/dt = 250\text{A}/\mu\text{s}$ $V_R = 100\text{V}, V_{GS} = 0\text{V}$		148	ns
$I_{RM}$			21	A
$Q_{RM}$			1.6	$\mu\text{C}$

Notes: 1: Pulse test,  $t \leq 300\mu\text{s}$ ; duty cycle,  $d \leq 2\%$ .  
\*: Current may be limited by external lead limit.

**PRELIMINARY TECHNICAL INFORMATION**

The product presented herein is under development. The Technical Specifications offered are derived from data gathered during objective characterizations of preliminary engineering lots; but also may yet contain some information supplied during a pre-production design evaluation. IXYS reserves the right to change limits, test conditions, and dimensions without notice.

IXYS reserves the right to change limits, test conditions, and dimensions.

### TO-263 (IXTA) Outline

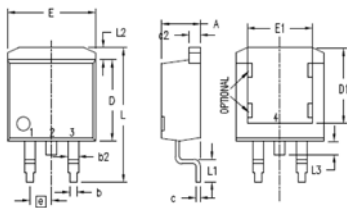

1. GATE
2. DRAIN (COLLECTOR)
3. SOURCE (EMITTER)
4. DRAIN (COLLECTOR) BOTTOM SIDE

SYM	INCHES		MILLIMETERS	
	MIN	MAX	MIN	MAX
A	.160	.190	4.06	4.83
A1	.080	.110	2.03	2.79
b	.020	.039	0.51	0.99
b2	.045	.055	1.14	1.40
c	.016	.029	0.40	0.74
c2	.045	.055	1.14	1.40
D	.340	.380	8.64	9.65
D1	.315	.350	8.00	8.89
E	.380	.410	9.65	10.41
E1	.245	.320	6.22	8.13
e	.100 BSC		2.54 BSC	
L	.575	.625	14.61	15.88
L1	.090	.110	2.29	2.79
L2	.040	.055	1.02	1.40
L3	.050	.070	1.27	1.78
L4	0	.005	0	0.13

### TO-220 (IXTP) Outline

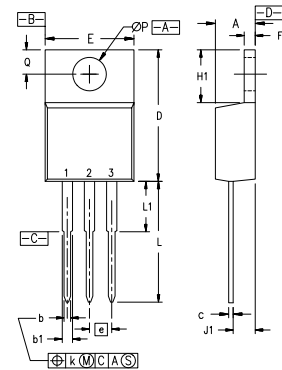

- Pins: 1 - Gate      2 - Drain

SYM	INCHES		MILLIMETERS	
	MIN	MAX	MIN	MAX
A	.170	.190	4.32	4.83
b	.025	.040	0.64	1.02
b1	.045	.065	1.15	1.65
c	.014	.022	0.35	0.56
D	.580	.630	14.73	16.00
E	.390	.420	9.91	10.66
e	.100 BSC		2.54 BSC	
F	.045	.055	1.14	1.40
H1	.230	.270	5.85	6.85
J1	.090	.110	2.29	2.79
k	0	.015	0	0.38
L	.500	.550	12.70	13.97
L1	.110	.230	2.79	5.84
ØP	.139	.161	3.53	4.08
Q	.100	.125	2.54	3.18

### TO-247 (IXTH) Outline

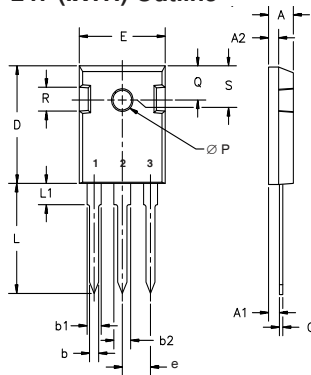

- Terminals: 1 - Gate      2 - Drain  
3 - Source      Tab - Drain

Dim.	Millimeter		Inches	
	Min.	Max.	Min.	Max.
A	4.7	5.3	.185	.209
A <sub>1</sub>	2.2	2.54	.087	.102
A <sub>2</sub>	2.2	2.6	.059	.098
b	1.0	1.4	.040	.055
b <sub>1</sub>	1.65	2.13	.065	.084
b <sub>2</sub>	2.87	3.12	.113	.123
C	.4	.8	.016	.031
D	20.80	21.46	.819	.845
E	15.75	16.26	.610	.640
e	5.20	5.72	0.205	0.225
L	19.81	20.32	.780	.800
L1		4.50		.177
ØP	3.55	3.65	.140	.144
Q	5.89	6.40	0.232	0.252
R	4.32	5.49	.170	.216
S	6.15 BSC		242 BSC	

### TO-3P (IXTQ) Outline

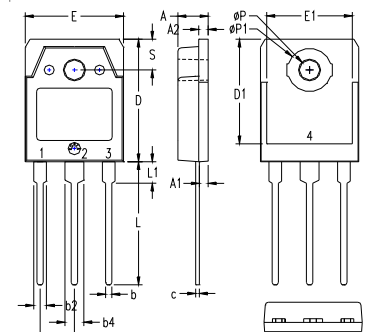

- 1 - GATE
- 2 - DRAIN (COLLECTOR)
- 3 - SOURCE (EMITTER)
- 4 - DRAIN (COLLECTOR)

SYM	INCHES		MILLIMETERS	
	MIN	MAX	MIN	MAX
A	.185	.193	4.70	4.90
A1	.051	.059	1.30	1.50
A2	.057	.065	1.45	1.65
b	.035	.045	0.90	1.15
b2	.075	.087	1.90	2.20
b4	.114	.126	2.90	3.20
c	.022	.031	0.55	0.80
D	.780	.799	19.80	20.30
D1	.665	.677	16.90	17.20
E	.610	.622	15.50	15.80
E1	.531	.539	13.50	13.70
e	.215 BSC		5.45 BSC	
L	.779	.795	19.80	20.20
L1	.134	.142	3.40	3.60
ØP	.126	.134	3.20	3.40
ØP1	.272	.280	6.90	7.10
S	.193	.201	4.90	5.10

### Leaded 262 (IXTI) Outline

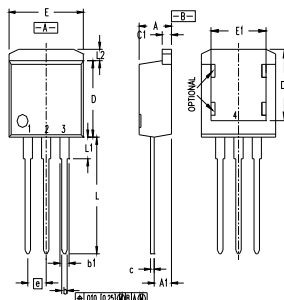

NOTE: This drawing will meet all dimensions requirement of JEDEC outline TO-262 AA.

SYM	INCHES		MILLIMETERS	
	MIN	MAX	MIN	MAX
A	.160	.190	4.06	4.83
A1	.080	.110	2.03	2.79
b	.025	.039	0.51	0.99
b2	.025	.039	1.14	1.40
c	.018	.029	0.46	0.74
c2	.018	.029	1.14	1.40
D	.340	.380	8.64	9.65
D1	.315	.350	8.00	8.89
E	.380	.405	9.65	10.29
E1	.245	.320	6.22	8.13
e	.100 BSC		2.54 BSC	
L	.500	.580	14.61	15.88
L1	.080	.130	2.29	2.79
L2	.040	.055	1.02	1.40

**Fig. 1. Output Characteristics**  
@ 25°C

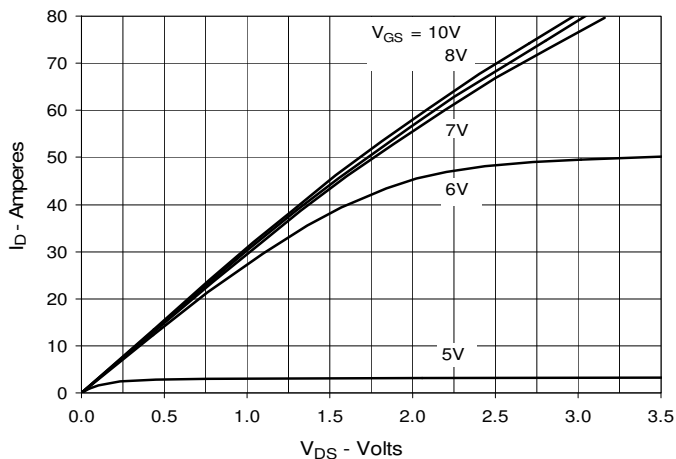

**Fig. 2. Extended Output Characteristics**  
@ 25°C

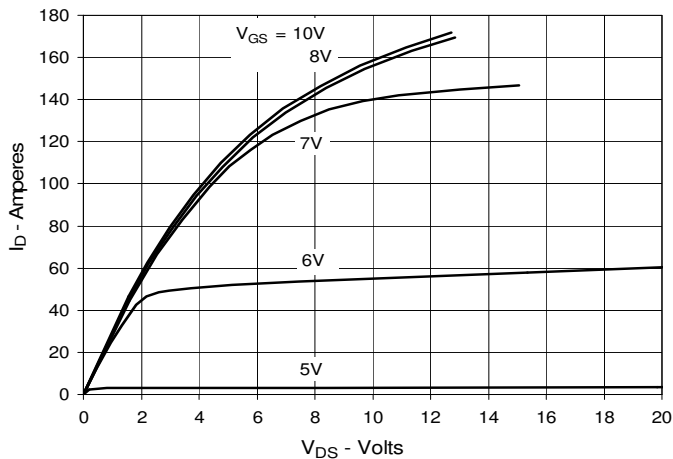

**Fig. 3. Output Characteristics**  
@ 125°C

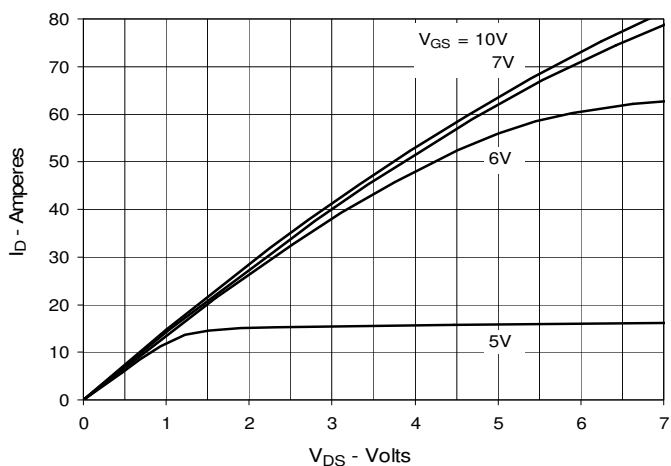

**Fig. 4.  $R_{DS(on)}$  Normalized to  $I_D = 38A$  Value vs. Junction Temperature**

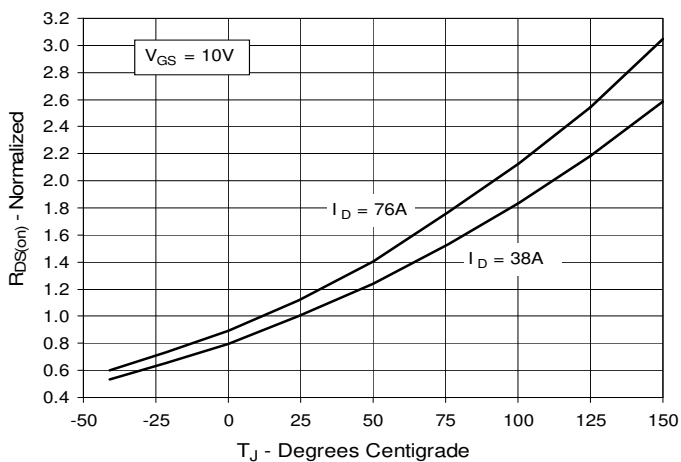

**Fig. 5.  $R_{DS(on)}$  Normalized to  $I_D = 38A$  Value vs. Drain Current**

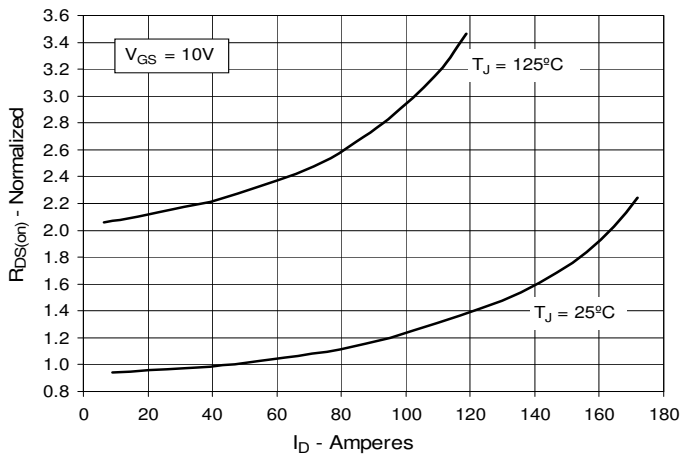

**Fig. 6. Drain Current vs. Case Temperature**

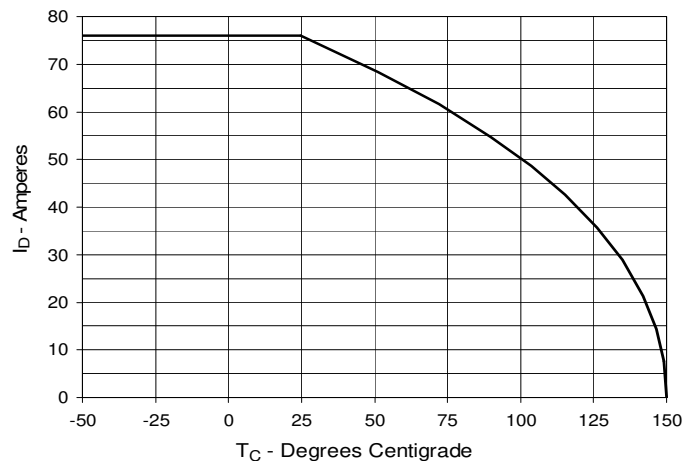

**Fig. 7. Input Admittance**

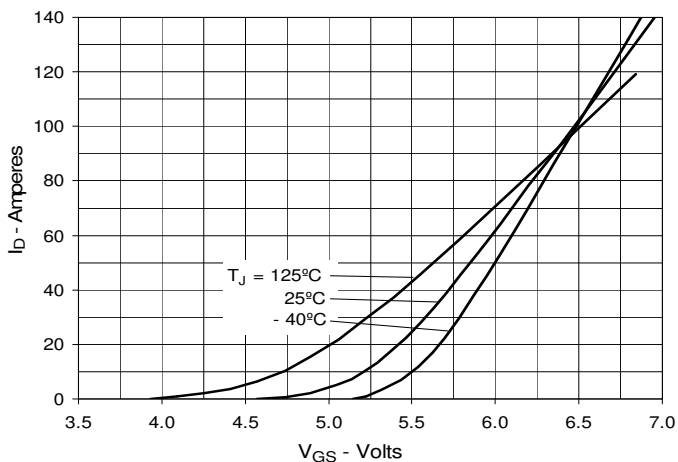

**Fig. 8. Transconductance**

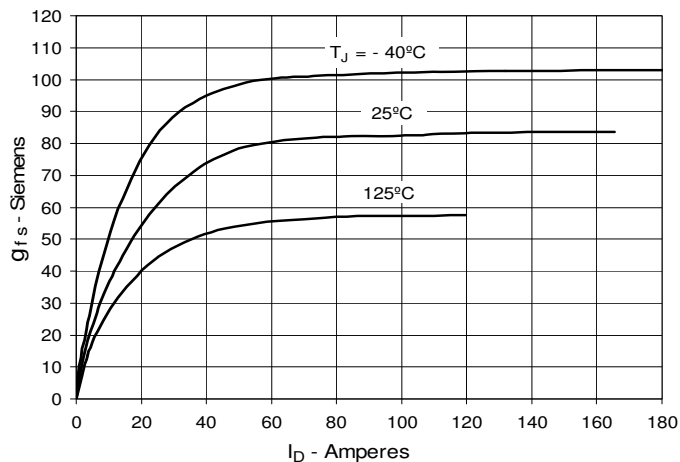

**Fig. 9. Forward Voltage Drop of Intrinsic Diode**

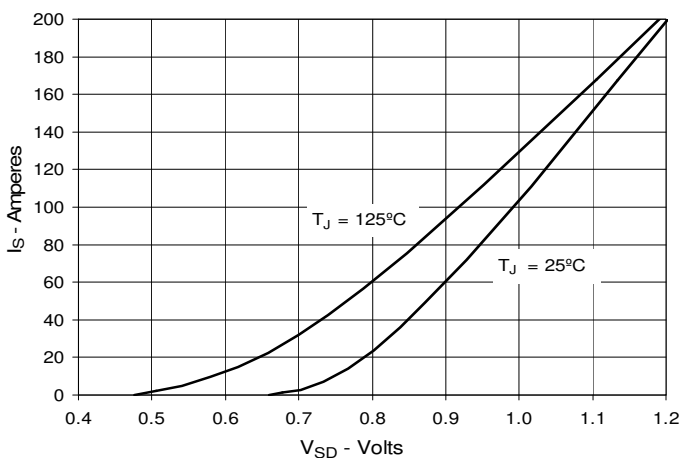

**Fig. 10. Gate Charge**

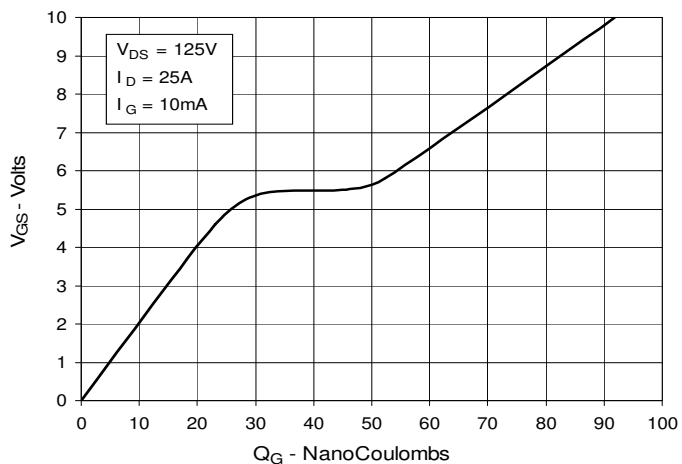

**Fig. 11. Capacitance**

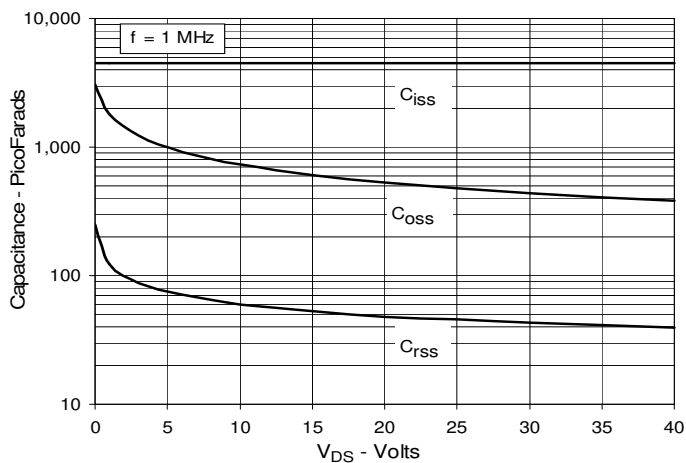

**Fig. 12. Maximum Transient Thermal Impedance**

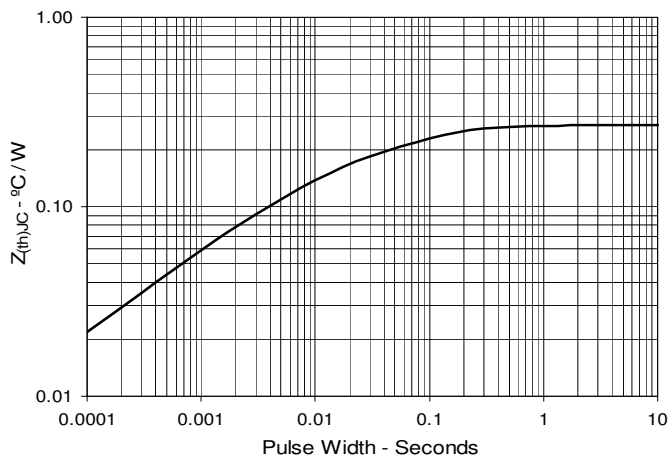

**Fig. 13. Resistive Turn-on Rise Time vs. Junction Temperature**

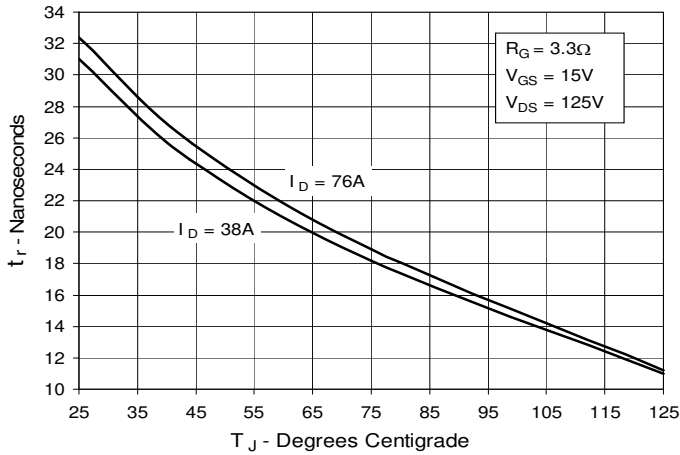

**Fig. 14. Resistive Turn-on Rise Time vs. Drain Current**

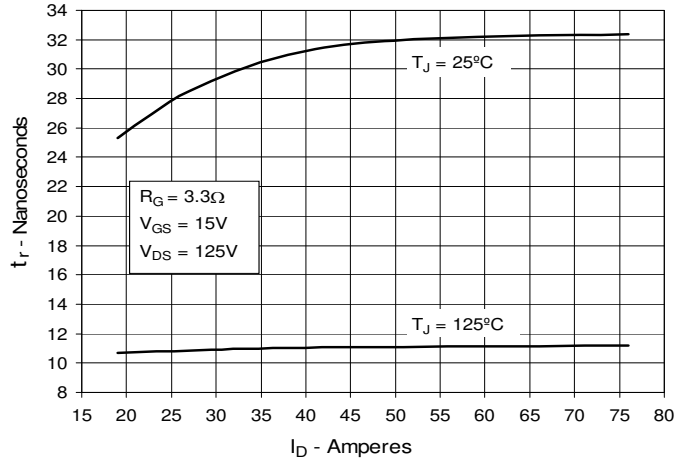

**Fig. 15. Resistive Turn-on Switching Times vs. Gate Resistance**

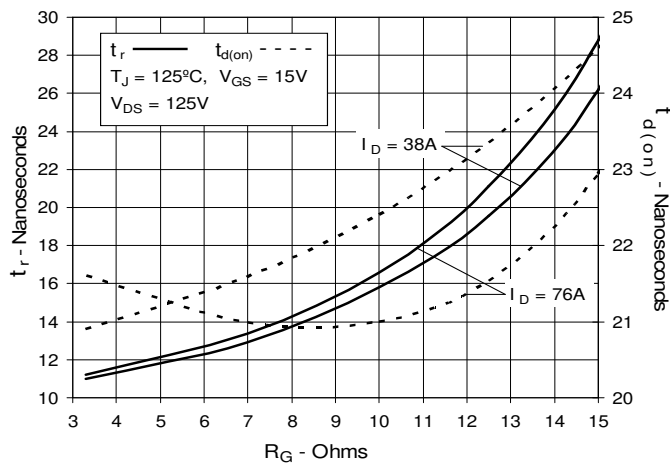

**Fig. 16. Resistive Turn-off Switching Times vs. Junction Temperature**

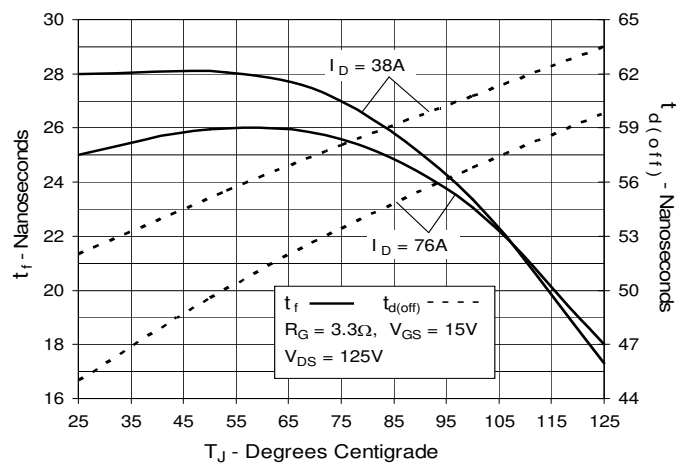

**Fig. 17. Resistive Turn-off Switching Times vs. Drain Current**

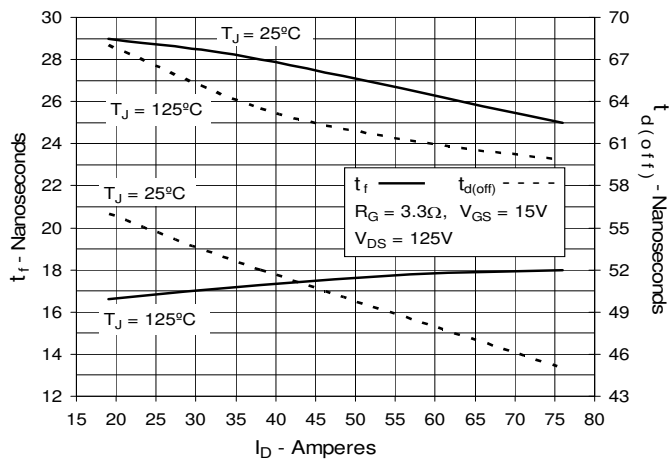

**Fig. 18. Resistive Turn-off Switching Times vs. Gate Resistance**

