



	IAA170P	Units
Load Voltage	350	V
Load Current	100	mA
Max R <sub>ON</sub>	50	Ω

### Description

The IAA170P multifunction switch combines 350V, 100mA, 50Ω relay(s) and optocoupler(s) into a single package. Various combinations are available depending on the part number. This switch provides an ideal way to consolidate functionality into a single package.

### Features

- Three Functions in One Package
- Small 16 Pin SOIC Package (PCMCIA Compatible)
- Bi-Directional Current Sensing
- Bi-Directional Current Switching
- Replaces up to Three or Four Components
- 3750V<sub>RMS</sub> Input/Output Isolation
- FCC Compatible
- No EMI/RFI Generation
- Machine Insertable, Wave Solderable

### Applications

- Telecommunications
  - Telecom Switching
  - Tip/Ring Circuits
  - Modem Switching (Laptop, Notebook, Pocket Size)
  - Hookswitch
  - Dial Pulsing
  - Ground Start
  - Ringer Injection
- Instrumentation
  - Multiplexers
  - Data Acquisition
  - Electronic Switching
  - I/O Subsystems
  - Meters (Watt-Hour, Water, Gas)
- Medical Equipment-Patient/Equipment Isolation
- Security
- Aerospace
- Industrial Controls

### Approvals

- Tape & Reel Versions Available
- UL Recognized: File Number E76270
- CSA Certified: File Number LR 43639-12
- VDE Compatible
- BSI Certified:
  - BS EN 60950:1992 (BS7002:1992)  
Certificate #:7969
  - BS EN 41003:1993  
Certificate #:7969

### Ordering Information

Part #	Description
IAA170P	16 Pin SOIC (50/Tube)
IAA170PTR	16 Pin SOIC (1000/Reel)

### Pin Configuration

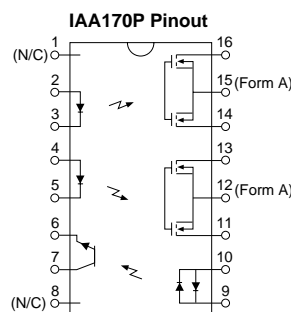

1. (N/C)
2. + LED - Form A Relay #1
3. - LED - Form A Relay #1
4. + LED - Form A Relay #2
5. - LED - Form A Relay #2
6. Emitter - Phototransistor
7. Collector - Phototransistor
8. (N/C)
9. LED - Phototransistor +/-
10. LED - Phototransistor +/-
11. Output - Form A Relay #2
12. Common Source Relay #2
13. Output - Form A Relay #2
14. Output - Form A Relay #1
15. Common Source Relay #1
16. Output - Form A Relay #1

Switching Characteristics of Normally Closed (Form B) Devices

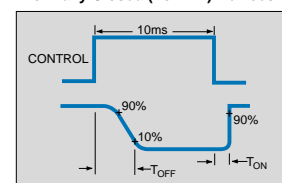

Switching Characteristics of Normally Open (Form A) Devices

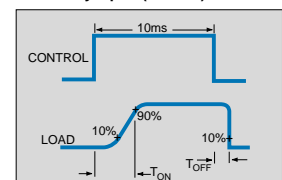

### Absolute Maximum Ratings (@ 25° C)

Parameter	Min	Typ	Max	Units
Total Package Dissipation	-	-	1 <sup>1</sup>	W
Isolation Voltage				
Input to Output	3750	-	-	V <sub>RMS</sub>
Operational Temperature	-40	-	+85	°C
Storage Temperature	-40	-	+125	°C
Soldering Temperature (10 Seconds Max.)	-	-	+220	°C

<sup>1</sup> Above 25° derate linearity 1.67mw/°C

*Absolute Maximum Ratings are stress ratings. Stresses in excess of these ratings can cause permanent damage to the device. Functional operation of the device at these or any other conditions beyond those indicated in the operational sections of this data sheet is not implied. Exposure of the device to the absolute maximum ratings for an extended period may degrade the device and effect its reliability.*

### Electrical Characteristics

Parameter	Conditions	Symbol	Min	Typ	Max	Units
<b>Relay Portion</b>						
<b>Output Characteristics @ 25°C</b>						
Load Voltage (Peak)	-	V <sub>L</sub>	-	-	350	V
Load Current (Continuous)	-	I <sub>L</sub>	-	-	100	mA
Peak Load Current	10ms	I <sub>LPK</sub>	-	-	350	mA
On-Resistance	I <sub>L</sub> =100mA	R <sub>ON</sub>	-	-	50	Ω
Off-State Leakage Current	V <sub>L</sub> =350V; T <sub>J</sub> =25°C	I <sub>LEAK</sub>	-	-	1	μA
<b>Switching Speeds</b>						
Turn-On	I <sub>F</sub> =5mA, V <sub>L</sub> =10V	T <sub>ON</sub>	-	-	5	ms
Turn-Off	I <sub>F</sub> =5mA, V <sub>L</sub> =10V	T <sub>OFF</sub>	-	-	5	ms
Output Capacitance	V <sub>L</sub> =50V, f=1MHz	-	-	25	-	pF
<b>Relay Portion</b>						
<b>Input Characteristics @ 25°C</b>						
Input Control Current	I <sub>L</sub> =100mA	I <sub>F</sub>	5	-	50	mA
Input Dropout Current	I <sub>L</sub> =1mA	I <sub>F</sub>	0.4	-	-	mA
Input Voltage Drop	I <sub>F</sub> =5mA	V <sub>F</sub>	0.9	1.2	1.4	V
Reverse Input Voltage	-	V <sub>R</sub>	-	-	5	V
Reverse Input Current	V <sub>R</sub> =5V	I <sub>R</sub>	-	-	10	μA
<b>Detector Portion</b>						
<b>Output Characteristics @ 25°C</b>						
Phototransistor Blocking Voltage	I <sub>C</sub> =10μA	B <sub>VCEO</sub>	20	50	-	V
Phototransistor Dark Current	V <sub>CE</sub> =5V, I <sub>F</sub> =0mA	I <sub>CEO</sub>	-	50	500	nA
Saturation Voltage	I <sub>C</sub> =2mA, I <sub>F</sub> =16mA	V <sub>SAT</sub>	-	0.3	0.5	V
Current Transfer Ratio	I <sub>F</sub> =6mA, V <sub>CE</sub> =0.5V	C <sub>TR</sub>	33	-	-	%
<b>Detector Portion</b>						
<b>Input Characteristics @ 25°C</b>						
Input Control Current	I <sub>C</sub> =2mA, V <sub>CE</sub> =0.5V	I <sub>F</sub>	6	2	-	mA
Input Voltage Drop	I <sub>F</sub> =5mA	I <sub>CEO</sub>	0.9	1.2	1.4	V
Input Current (Detector must be off)	I <sub>C</sub> =1μA, V <sub>CE</sub> =5V	-	5	25	-	μA
Input to Output Capacitance	V <sub>L</sub> =50V, f=1MHz	C <sub>I/O</sub>	-	3	-	pF
Input to Output Isolation	-	V <sub>I/O</sub>	3750	-	-	V <sub>RMS</sub>

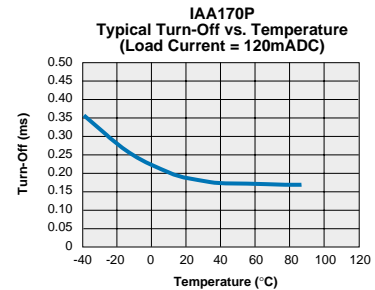
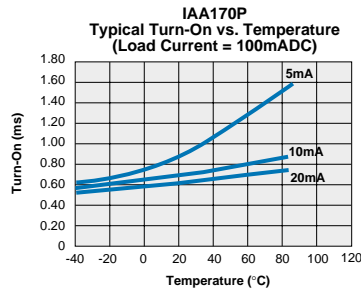
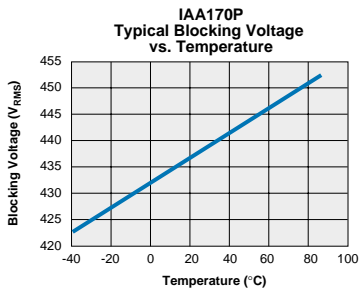
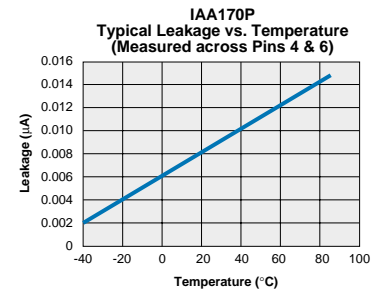
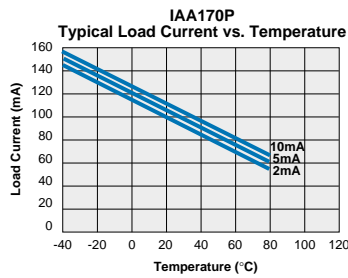
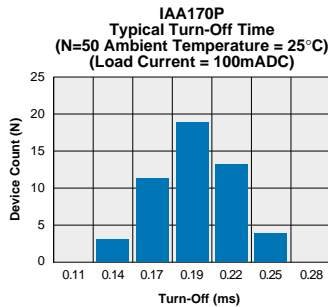
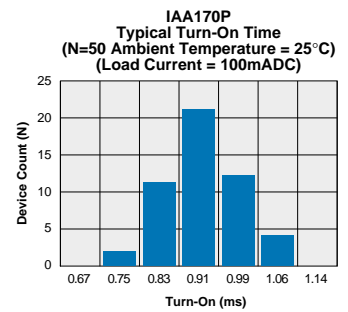
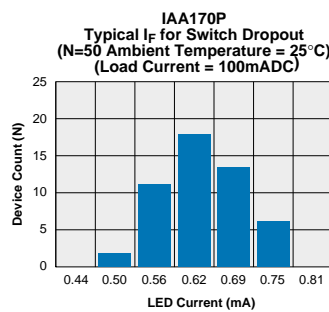
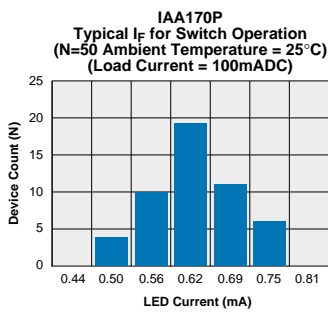
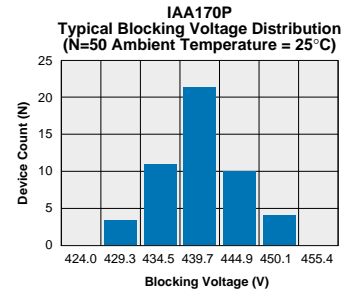
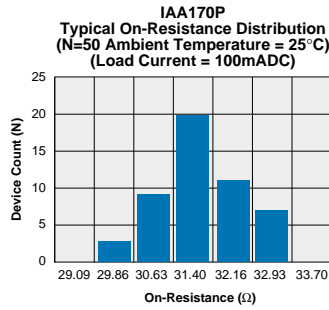
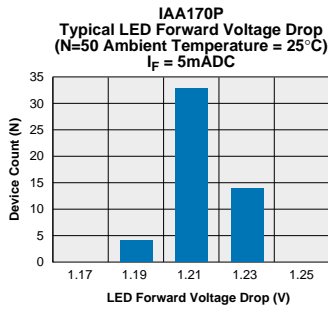
**PERFORMANCE DATA\***

The Performance data shown in the graphs above is typical of device performance. For guaranteed parameters not indicated in the written specifications, please contact our application department.

PERFORMANCE DATA\*

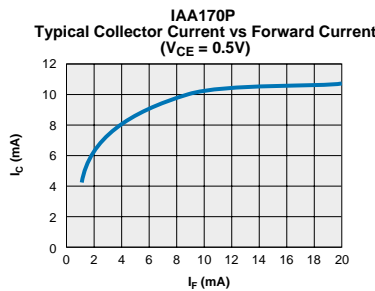
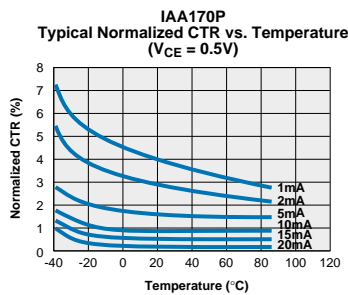
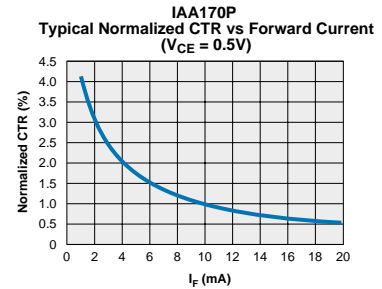
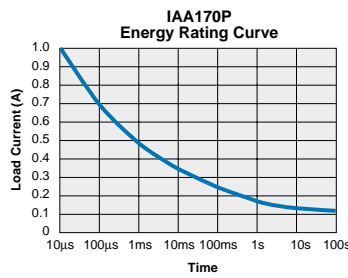
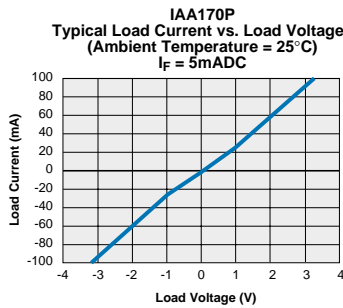
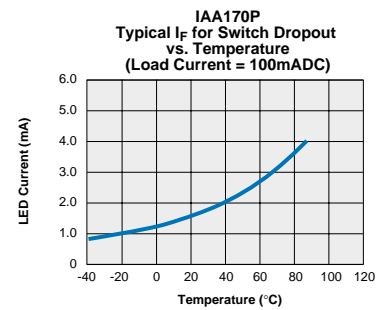
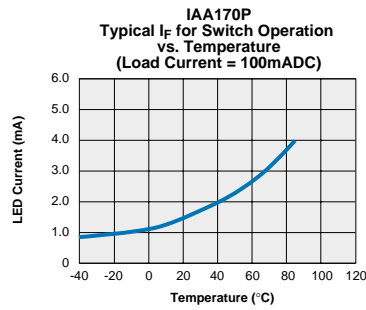
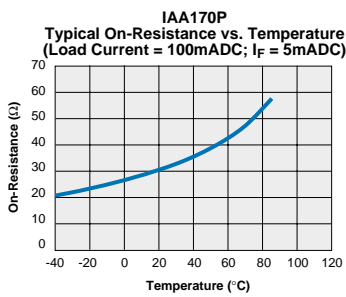
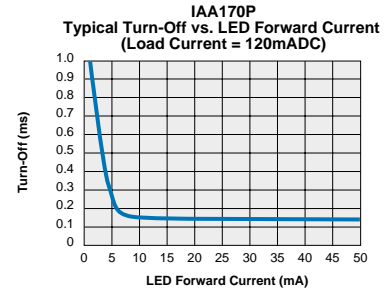
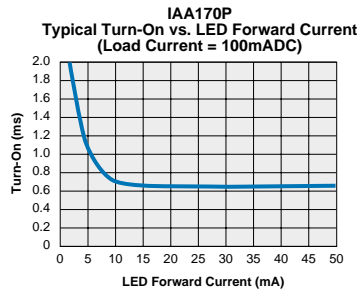
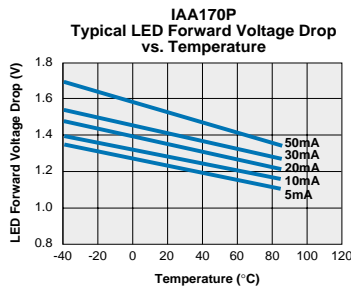

\*The Performance data shown in the graphs above is typical of device performance. For guaranteed parameters not indicated in the written specifications, please contact our application department.

### Mechanical Dimensions

16 Pin SOIC ("P" Suffix)

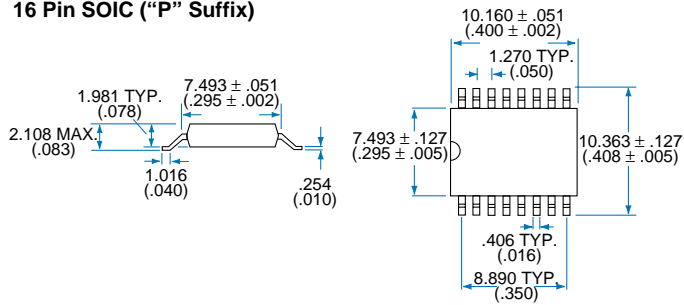

PC Board Pattern (Top View)

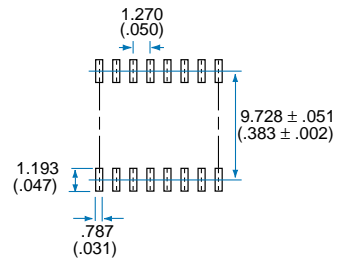

Tape and Reel Packaging for 16 Pin SOIC Package

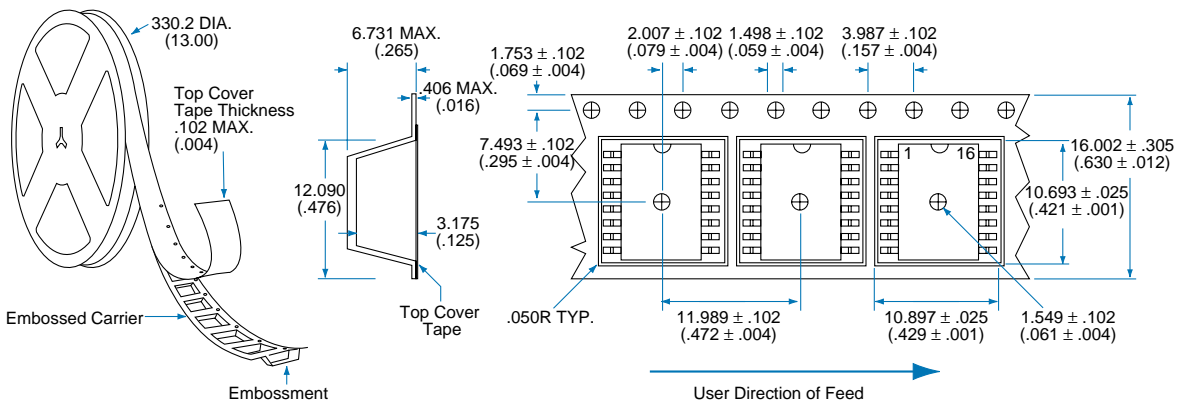

Dimensions  
mm  
(inches)



# CLARE

---

**For additional information please visit our website at: [www.clare.com](http://www.clare.com)**

*Clare, Inc. makes no representations or warranties with respect to the accuracy or completeness of the contents of this publication and reserves the right to make changes to specifications and product descriptions at any time without notice. Neither circuit patent licenses nor indemnity are expressed or implied. Except as set forth in Clare's Standard Terms and Conditions of Sale, Clare, Inc. assumes no liability whatsoever, and disclaims any express or implied warranty, relating to its products including, but not limited to, the implied warranty of merchantability, fitness for a particular purpose, or infringement of any intellectual property right.*

*The products described in this document are not designed, intended, authorized or warranted for use as components in systems intended for surgical implant into the body, or in other applications intended to support or sustain life, or where malfunction of Clare's product may result in direct physical harm, injury, or death to a person or severe property or environmental damage. Clare, Inc. reserves the right to discontinue or make changes to its products at any time without notice.*

Specification: DS-IAA170P-R1.0  
©Copyright 2002, Clare, Inc.  
All rights reserved. Printed in USA.  
6/25/02