

## Digital Attenuator 30 dB, 4-Bit, TTL Driver, DC - 3 GHz

Rev. V5

### Features

- Attenuation: 2 dB Steps to 30 dB
- Low DC Power Consumption
- Integral TTL Driver
- 50 Ω Impedance
- Temperature Stability:  
±0.18 dB from -55°C to +85°C
- Lead-Free SO-16 Package
- 100% Matte Tin Plating over Copper
- Halogen-Free “Green” Mold Compound
- 260°C Reflow Compatible
- RoHS\* Compliant Version of AT65-0233

### Description

The MAATCC0006 is a GaAs FET 4-bit digital attenuator with a 2 dB minimum step size and a 30 dB total attenuation range. This device is in a SOIC-16 plastic surface mount package.

The MAATCC0006 is ideally suited for use where accuracy, fast speed, very low power consumption is required. Typical applications include dynamic range setting in precision receiver circuits and other gain/leveling control circuits.

### Ordering Information<sup>1</sup>

| Part Number   | Package           |
|---------------|-------------------|
| MAATCC0006    | Bulk Packaging    |
| MAATCC0006TR  | 1000 piece reel   |
| MAATCC0006-TB | Sample Test Board |

1. Reference Application Note M513 for reel size information.

### Schematic with Off-Chip Components or Functional Block Diagram

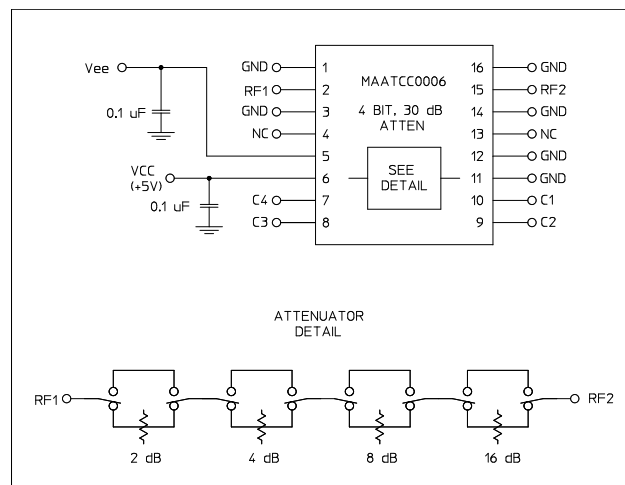

### Pin Configuration

| Pin # | Function        | Pin # | Function        |
|-------|-----------------|-------|-----------------|
| 1     | GND             | 9     | C2              |
| 2     | RF1             | 10    | C1              |
| 3     | GND             | 11    | GND             |
| 4     | NC <sup>2</sup> | 12    | GND             |
| 5     | Vee             | 13    | NC <sup>2</sup> |
| 6     | Vcc             | 14    | GND             |
| 7     | C4              | 15    | RF2             |
| 8     | C3              | 16    | GND             |

2. NC = No Connection

\* Restrictions on Hazardous Substances, compliant to current RoHS EU directive.

## Digital Attenuator 30 dB, 4-Bit, TTL Driver, DC - 3 GHz

Rev. V5

### Electrical Specifications: $T_A = 25^\circ\text{C}$

| Parameter   | Test Conditions  | Units         | Min.                       | Typ.       | Max.  |
|---|--|---------------|----------------------------|------------|-------|
| Insertion Loss  | DC - 0.5 GHz   | dB            | —                          | 1.7        | 2.0   |
|   | DC - 2.0 GHz   |               |                            | 2.3        | 2.7   |
|   | DC - 3.0 GHz   |               |                            | 2.6        | 3.1   |
| Attenuation Accuracy  | Any Bit or Combination of Bits<br>DC - 3.0 GHz             | dB            | ± (.4 + 8% of attenuation) |            |       |
| VSWR  | Full Range<br>DC - 3.0 GHz                                 | Ratio         | —                          | —          | 1.7:1 |
| Trise, Tfall<br>Ton, Toff<br>Transients                             | 10% to 90%   | ns            | —                          | 10         | 50    |
|   | 50% Cntl to 90%/10% RF                                     | ns            |                            | 30         | 150   |
|   | In-Band  | mV            |                            | 35         | —     |
| 1 dB Compression  | Input Power<br>0.05 GHz<br>0.5 - 3.0 GHz                   | dBm           | —                          | +20<br>+28 | —     |
| Input $IP_3$  | Two-tone inputs up to +5 dBm<br>0.05 GHz<br>0.5 - 3.0 GHz  | dBm           | —                          | +40<br>+50 | —     |
| Input $IP_2$  | Two-tone inputs up to +5 dBm<br>0.05 GHz<br>0.5 - 3.0 GHz  | dBm           | —                          | +45<br>+68 | —     |
| VCC   | —  | V             | 4.5                        | 5.0        | 5.5   |
| VEE   | —  | V             | -8.0                       | -5.0       | -4.75 |
| $V_{IL}$  | LOW-level input voltage<br>HIGH-level input voltage        | V             | 0.0                        | —          | 0.8   |
| $V_{IH}$  |  |               | 2.0                        | —          | 5.0   |
| $I_{in}$ (Input Leakage Current)                                    | $V_{in} = V_{CC}$ or GND                                   | $\mu\text{A}$ | -1.0                       | —          | 1.0   |
| $I_{cc}$<br>(Quiescent Supply Current)                              | $V_{ctrl} = V_{CC}$ or GND                                 | $\mu\text{A}$ | —                          | 250        | 400   |
| $\Delta I_{cc}$<br>(Additional Supply Current Per TTL<br>Input Pin) | $V_{CC} = \text{Max}$ , $V_{ctrl} = V_{CC} - 2.1\text{ V}$ | mA            | —                          | —          | 1.0   |
| IEE   | VEE min to max, $V_{in} = V_{IL}$ or $V_{IH}$              | mA            | -1.0                       | -0.2       | —     |

### Absolute Maximum Ratings<sup>3,4</sup>

| Parameter                                | Absolute Maximum  |
|--|---|
| Input Power<br>0.05 GHz<br>0.5 - 3.0 GHz | +27 dBm<br>+34 dBm                                      |
| $V_{CC}$                                 | $-0.5\text{ V} \leq V_{CC} \leq +7.0\text{ V}$          |
| $V_{EE}$                                 | $-8.5\text{ V} \leq V_{EE} \leq +0.5\text{ V}$          |
| $V_{CC} - V_{EE}$                        | $-0.5\text{ V} \leq V_{CC} - V_{EE} \leq 14.5\text{ V}$ |
| $V_{in}^5$                               | $-0.5\text{ V} \leq V_{in} \leq V_{CC} + 0.5\text{ V}$  |
| Operating Temperature                    | -40°C to +85°C  |
| Storage Temperature                      | -65°C to +125°C   |

- Exceeding any one or combination of these limits may cause permanent damage to this device.
- MACOM does not recommend sustained operation near these survivability limits.
- Standard CMOS TTL interface, latch-up will occur if logic signal applied prior to power supply.

### Truth Table (Digital Attenuator)<sup>6</sup>

| C1 | C2 | C3 | C4 | Attenuation     |
|----|----|----|----|-----------------|
| 0  | 0  | 0  | 0  | Loss, Reference |
| 1  | 0  | 0  | 0  | 2.0 dB          |
| 0  | 1  | 0  | 0  | 4.0 dB          |
| 0  | 0  | 1  | 0  | 8.0 dB          |
| 0  | 0  | 0  | 1  | 16.0 dB         |
| 1  | 1  | 1  | 1  | 30.0 dB         |

6. 0 = TTL Low; 1 = TTL High

## Typical Performance Curves

**Typical Insertion Loss (dB)**

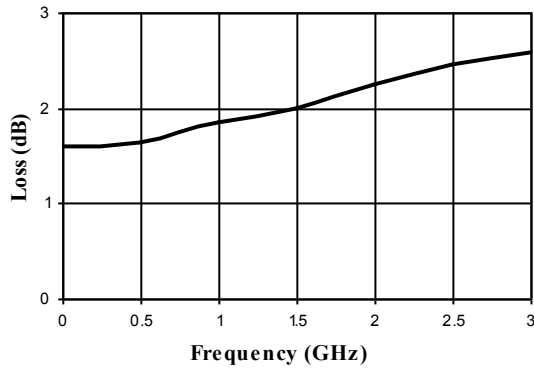

**Attenuation Accuracy, 2 dB**

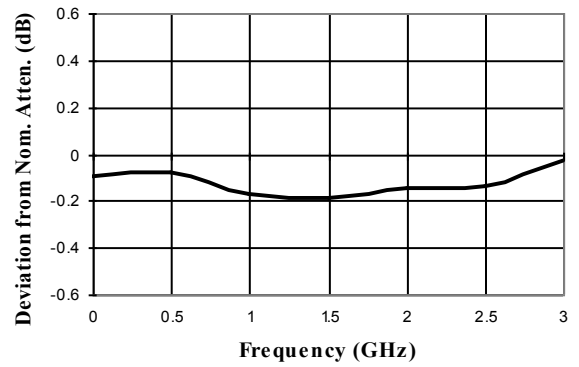

**Attenuation Accuracy, 4 dB**

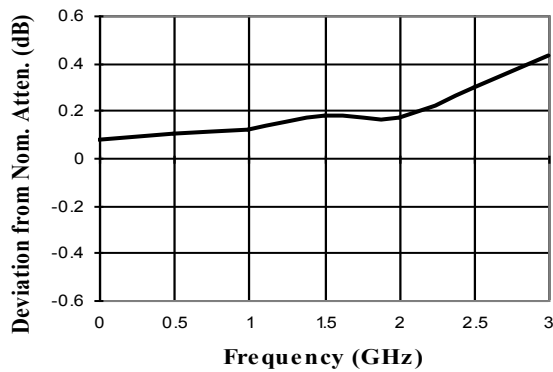

**Attenuation Accuracy, 8 dB**

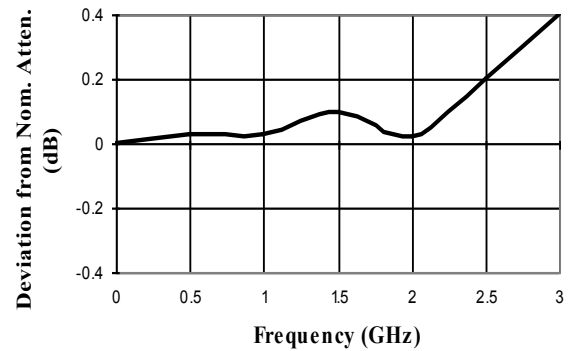

## Typical Performance Curves

**Attenuation Accuracy, 16 dB**

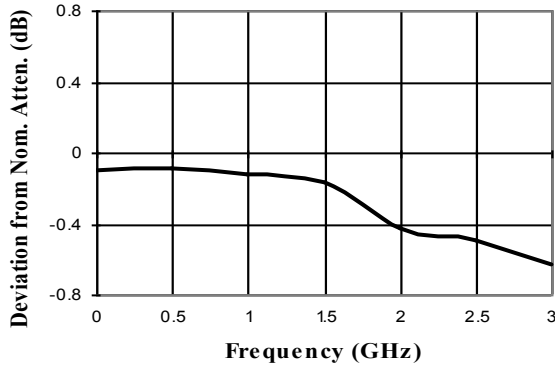

**Attenuation Accuracy, 30 dB**

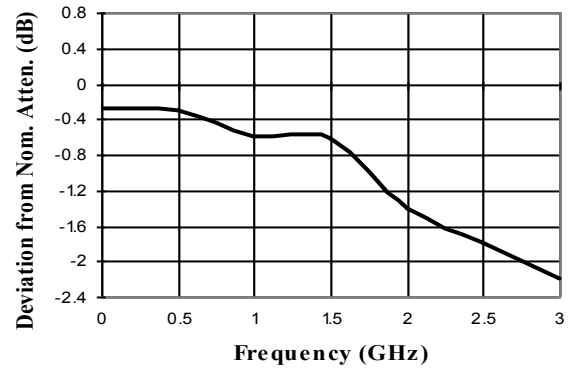

**Typical RF1 VSWR**

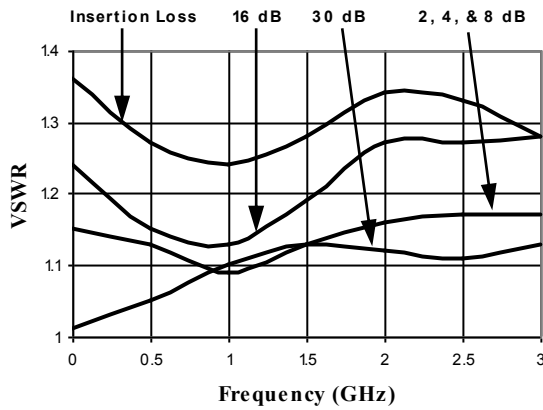

**Typical RF2 VSWR**

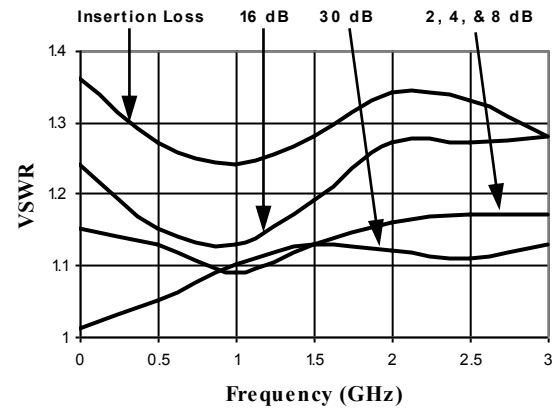

## Digital Attenuator 30 dB, 4-Bit, TTL Driver, DC - 3 GHz

Rev. V5

### Handling Procedures

Please observe the following precautions to avoid damage:

### Static Sensitivity

Gallium Arsenide Integrated Circuits are sensitive to electrostatic discharge (ESD) and can be damaged by static electricity. Proper ESD control techniques should be used when handling these devices.

### Lead-Free, SOIC-16<sup>†</sup>

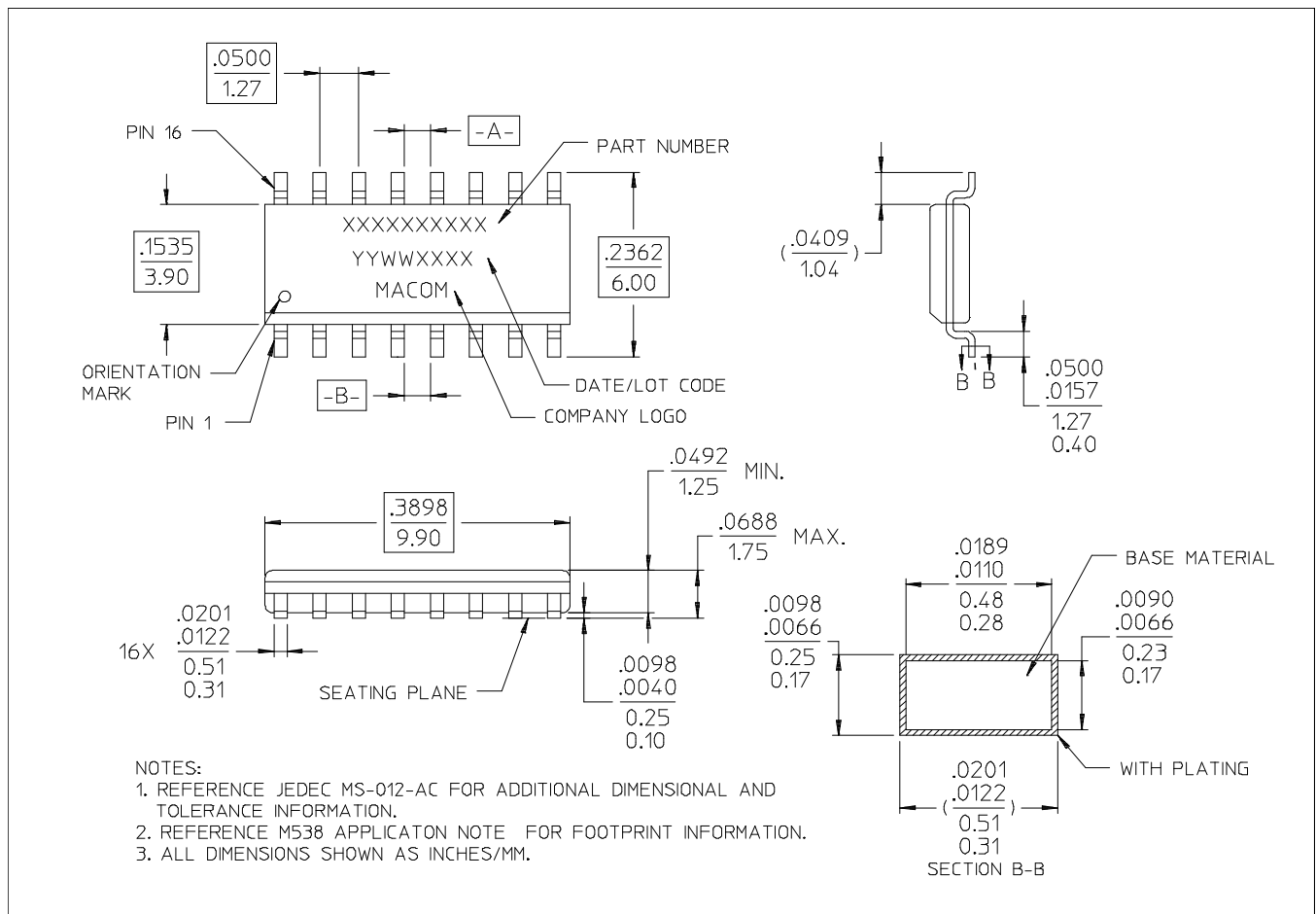

<sup>†</sup> Reference Application Note M538 for lead-free solder reflow recommendations.

MACOM Technology Solutions Inc. All rights reserved.

Information in this document is provided in connection with MACOM Technology Solutions Inc ("MACOM") products. These materials are provided by MACOM as a service to its customers and may be used for informational purposes only. Except as provided in MACOM's Terms and Conditions of Sale for such products or in any separate agreement related to this document, MACOM assumes no liability whatsoever. MACOM assumes no responsibility for errors or omissions in these materials. MACOM may make changes to specifications and product descriptions at any time, without notice. MACOM makes no commitment to update the information and shall have no responsibility whatsoever for conflicts or incompatibilities arising from future changes to its specifications and product descriptions. No license, express or implied, by estoppel or otherwise, to any intellectual property rights is granted by this document.

THESE MATERIALS ARE PROVIDED "AS IS" WITHOUT WARRANTY OF ANY KIND, EITHER EXPRESS OR IMPLIED, RELATING TO SALE AND/OR USE OF MACOM PRODUCTS INCLUDING LIABILITY OR WARRANTIES RELATING TO FITNESS FOR A PARTICULAR PURPOSE, CONSEQUENTIAL OR INCIDENTAL DAMAGES, MERCHANTABILITY, OR INFRINGEMENT OF ANY PATENT, COPYRIGHT OR OTHER INTELLECTUAL PROPERTY RIGHT. MACOM FURTHER DOES NOT WARRANT THE ACCURACY OR COMPLETENESS OF THE INFORMATION, TEXT, GRAPHICS OR OTHER ITEMS CONTAINED WITHIN THESE MATERIALS. MACOM SHALL NOT BE LIABLE FOR ANY SPECIAL, INDIRECT, INCIDENTAL, OR CONSEQUENTIAL DAMAGES, INCLUDING WITHOUT LIMITATION, LOST REVENUES OR LOST PROFITS, WHICH MAY RESULT FROM THE USE OF THESE MATERIALS.

MACOM products are not intended for use in medical, lifesaving or life sustaining applications. MACOM customers using or selling MACOM products for use in such applications do so at their own risk and agree to fully indemnify MACOM for any damages resulting from such improper use or sale.