

Overview

KEMET L-DMI ferrite-based Multilayer Chip Power Inductors are ideal for use in DC to DC switching power supplies. The small size of this chip inductor makes it suitable for mobile equipment that requires tight space both in dimension and in height. The internal printed coil structure creates a closed magnetic circuit, which acts as a magnetic shield eliminating crosstalk, thus permitting higher mounting densities. The multilayer block structure yields higher reliability. In addition, the inductor shows excellent low DC power dissipation, due to low Rdc with a high aspect ratio internal conductor that stands on unique green sheet and printing technologies.

Applications

- Switching DC-DC power supplies
- Wearables
- Smartphone
- Tablet device
- Digital still camera
- HDD

Benefits

- Unique green sheet and printing technologies
- High reliability
- High current
- Low DCR
- Inductance value from 0.47 – 4.7 μH
- Rated current range from 0.65 – 1.8 A
- Operating temperature range from -40°C to $+85^{\circ}\text{C}$
- Low profile 1.2 mm maximum

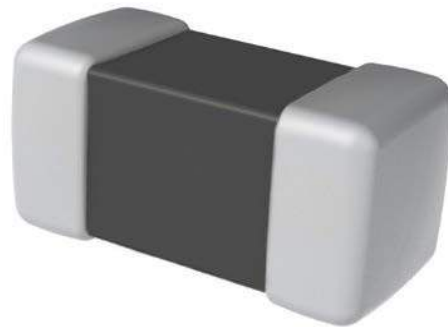

Part Number System

L	0603	C	1R0	M	DMI	T
Inductor	EIA Case Size (L" x W")	Specification	Inductance Value (μH)	Inductance Tolerance	Series	Packaging
	0603 (1608 in mm) 0805 (2012 in mm) 0806 (2016 in mm) 1008 (2520 in mm)	C = Commercial L = 0.8 mm maximum height S = High saturation type Q = 1.2 mm maximum height	R = decimal point Examples: R47 = 0.47 μH 1R0 = 1.0 μH	M = $\pm 20\%$	DMI = High current multilayer chip type	T = Tape & Reel

Dimensions – Millimeters (Inches)

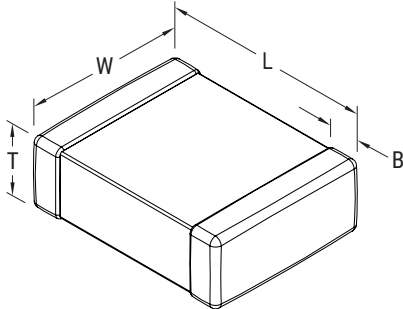
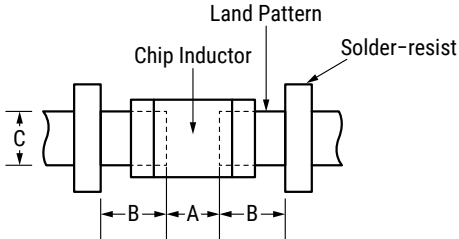
Dimensions - Millimeters (Inches)						Land Pattern - Millimeters		
								
EIA Size Code	Metric Size Code	L Length	W Width	T Thickness	B Bandwidth	A	B	C
0603	1608	1.60 (0.063) ±0.15 (0.006)	0.80 (0.031) ±0.15 (0.006)	0.95 (0.037) Maximum	0.30 (0.012) ±0.20 (0.008)	0.8 ~ 1.0	0.6 ~ 0.8	0.6 ~ 0.8
0805	2012	2.00 (0.079) ±0.20 (0.008)	1.25 (0.049) ±0.20 (0.008)	1.00 (0.039) Maximum	0.50 (0.020) ±0.30 (0.012)	0.8 ~ 1.2	0.8 ~ 1.2	0.9 ~ 1.6
0806	2016	2.00 (0.079) ±0.20 (0.008)	1.60 (0.063) ±0.20 (0.008)	1.00 (0.039) Maximum	0.50 (0.020) ±0.30 (0.012)	0.8 ~ 1.2	0.8 ~ 1.2	1.2 ~ 2.0
1008	2520	2.50 (0.098) ±0.20 (0.008)	2.00 (0.079) ±0.20 (0.008)	0.80 (0.031) Maximum	0.50 (0.020) ±0.30 (0.012)	1.0 ~ 1.4	0.6 ~ 1.0	1.8 ~ 2.2
				1.00 (0.039) Maximum				
				1.20 (0.047) Maximum				

Performance Characteristics

Item	Performance Characteristics
Operating Temperature Range	-40°C to +85°C
Rated Inductance Range	0.47 – 4.7 µH
Inductance Tolerance	±20%
Inductance Measurement Condition	1 MHz
Rated Current Range	0.65 – 1.8 A
Rated DC Resistance Range Typical	0.04 – 0.27 Ω
Rated DC Resistance Range Maximum	0.05 – 0.3 Ω

Environmental Compliance

All KEMET Chip Inductors are RoHS and REACH Compliant.



Table 1 – Ratings & Part Number Reference

Part Number	Inductance (μ H) at 1 MHz	Inductance Tolerance	DC Resistance (Ω) Typical	DC Resistance (Ω) Maximum	Rated Current (A) Maximum ¹
L0603CR50MDMIT	0.5	$\pm 20\%$	0.12	0.15	0.9
L0603C1R0MDMIT	1.0	$\pm 20\%$	0.17	0.2	0.75
L0603C2R2MDMIT	2.2	$\pm 20\%$	0.27	0.3	0.65
L0805CR47MDMIT	0.47	$\pm 20\%$	0.06	0.08	1.2
L0805C1R0MDMIT	1.0	$\pm 20\%$	0.11	0.14	1
L0805C1R5MDMIT	1.5	$\pm 20\%$	0.15	0.2	0.8
L0805C2R2MDMIT	2.2	$\pm 20\%$	0.15	0.2	0.8
L0805C3R3MDMIT	3.3	$\pm 20\%$	0.2	0.24	0.7
L0805C4R7MDMIT	4.7	$\pm 20\%$	0.23	0.28	0.7
L0806CR47MDMIT	0.47	$\pm 20\%$	0.06	0.075	1.6
L0806C1R0MDMIT	1.0	$\pm 20\%$	0.09	0.12	1.3
L0806C1R5MDMIT	1.5	$\pm 20\%$	0.1	0.13	1.2
L0806C2R2MDMIT	2.2	$\pm 20\%$	0.11	0.14	1.2
L0806C3R3MDMIT	3.3	$\pm 20\%$	0.13	0.16	1.1
L0806C4R7MDMIT	4.7	$\pm 20\%$	0.16	0.2	0.9
L1008CR47MDMIT	0.47	$\pm 20\%$	0.04	0.05	1.8
L1008C1R0MDMIT	1.0	$\pm 20\%$	0.07	0.08	1.4
L1008C1R5MDMIT	1.5	$\pm 20\%$	0.08	0.09	1.3
L1008C2R2MDMIT	2.2	$\pm 20\%$	0.08	0.09	1.3
L1008C3R3MDMIT	3.3	$\pm 20\%$	0.09	0.12	1.2
L1008C4R7MDMIT	4.7	$\pm 20\%$	0.12	0.15	1.1
L1008L1R5MDMIT	1.5	$\pm 20\%$	0.08	0.09	1.3
L1008L2R2MDMIT	2.2	$\pm 20\%$	0.08	0.1	1.2
L1008S1R0MDMIT	1.0	$\pm 20\%$	0.09	0.115	1.2
L1008S2R2MDMIT	2.2	$\pm 20\%$	0.09	0.115	1.2
L1008S4R7MDMIT	4.7	$\pm 20\%$	0.14	0.16	1.1
L1008Q1R0MDMIT	1.0	$\pm 20\%$	0.09	0.12	1.2
L1008Q2R2MDMIT	2.2	$\pm 20\%$	0.12	0.15	1.1
L1008Q3R3MDMIT	3.3	$\pm 20\%$	0.11	0.15	1.1
L1008Q4R7MDMIT	4.7	$\pm 20\%$	0.14	0.16	1.1
Part Number	Inductance (μ H) at 1 MHz	Inductance Tolerance	DC Resistance (Ω) Typical	DC Resistance (Ω) Maximum	Rated Current (A) Maximum ¹

¹ T = 40 K rise at rated current at 20°C

DC-Superposed Characteristics

L0603CR50MDMIT

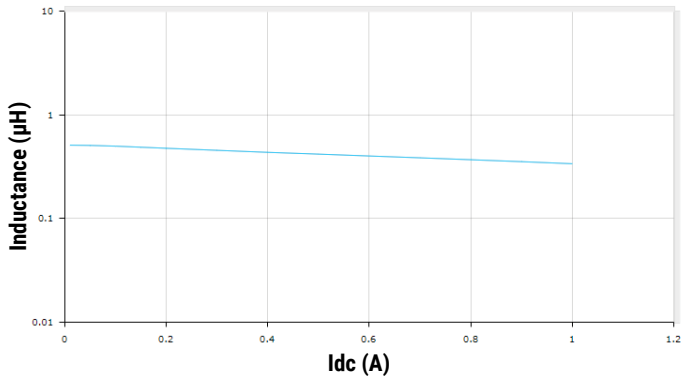

L0603C1R0MDMIT

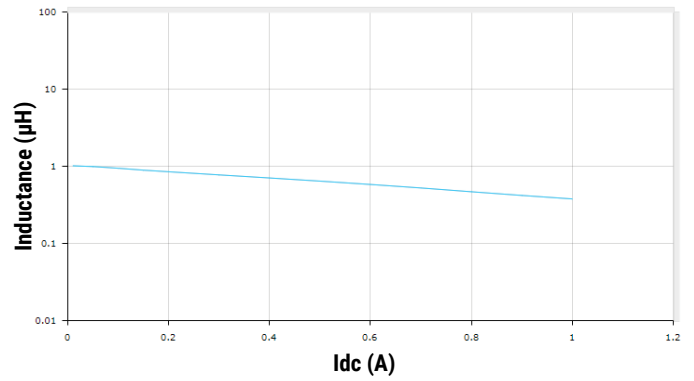

L0603C2R2MDMIT

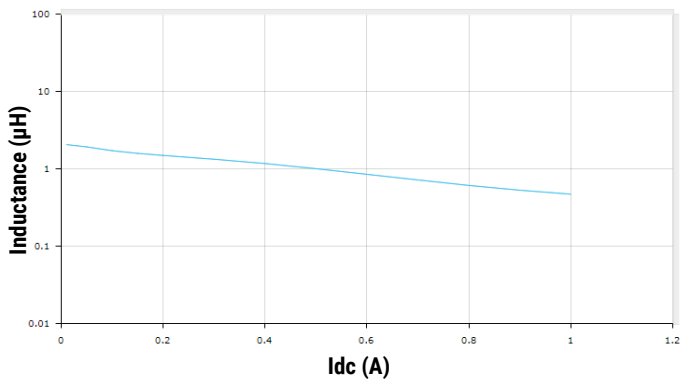

L0805CR47MDMIT

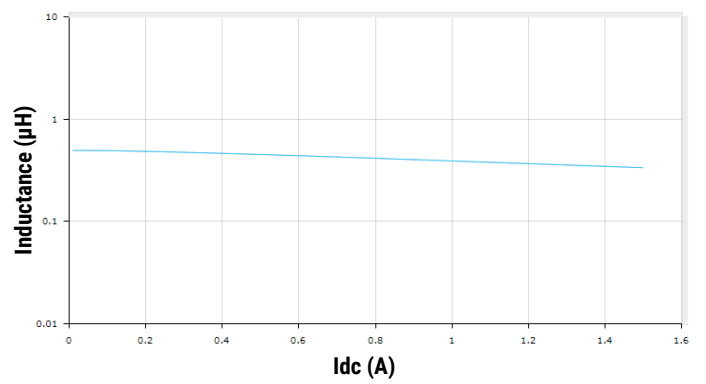

L0805C1R0MDMIT

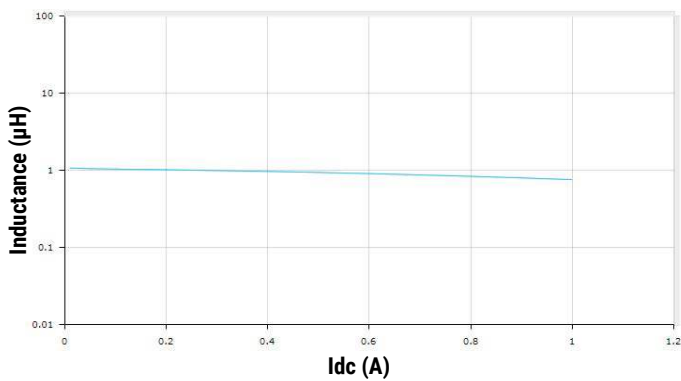

L0805C1R5MDMIT

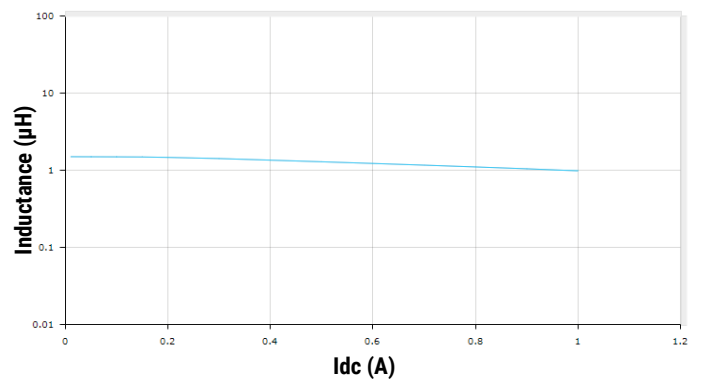

DC-Superposed Characteristics cont.

L0805C2R2MDMIT

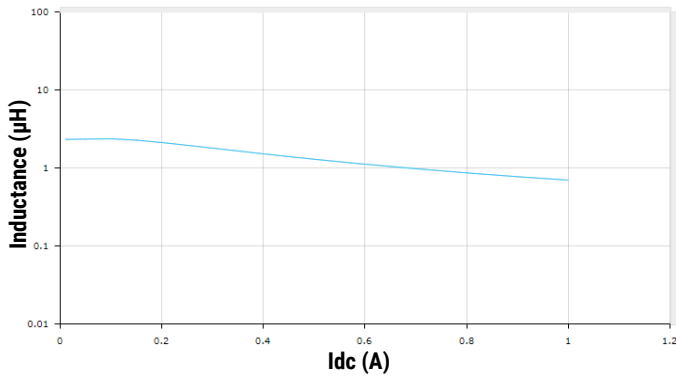

L0805C3R3MDMIT

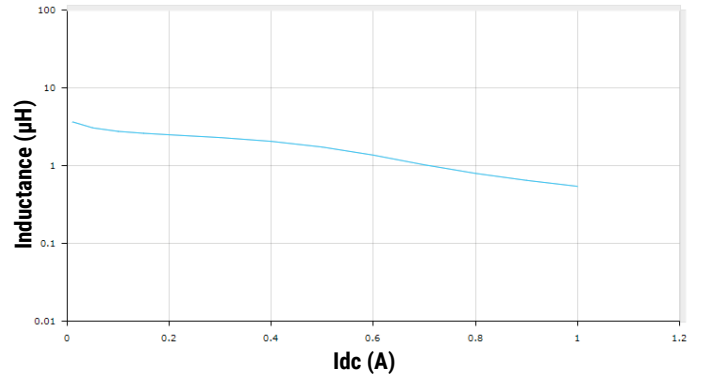

L0805C4R7MDMIT

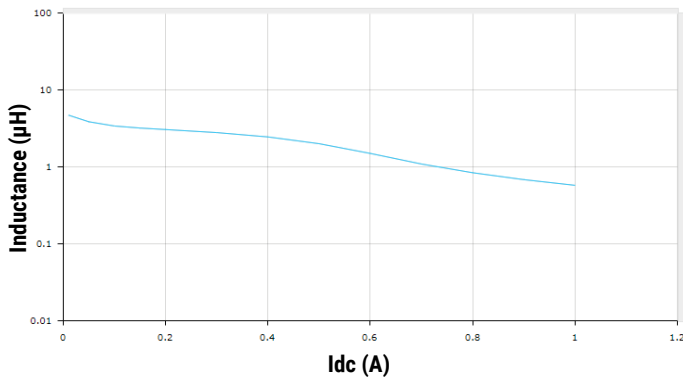

L0806CR47MDMIT

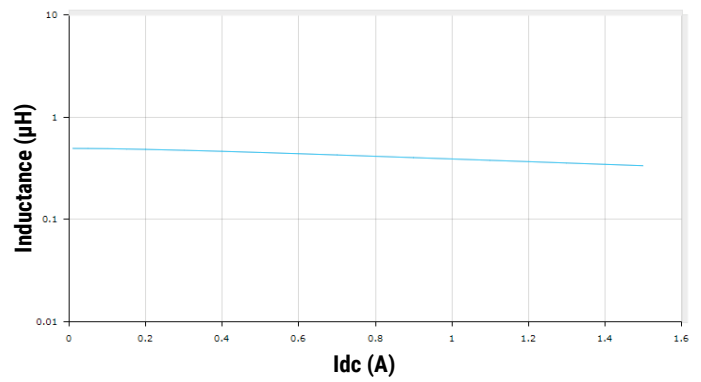

L0806C1R0MDMIT

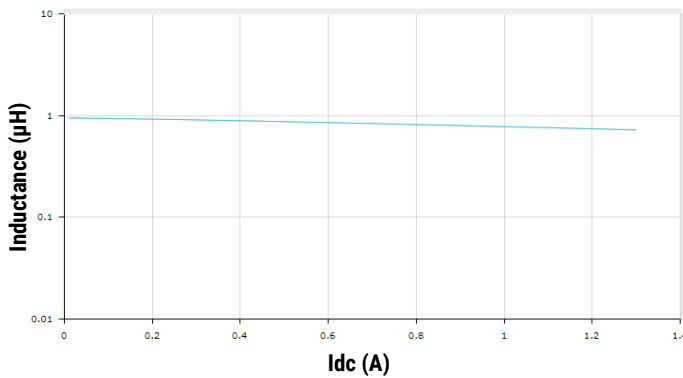

L0806C1R5MDMIT

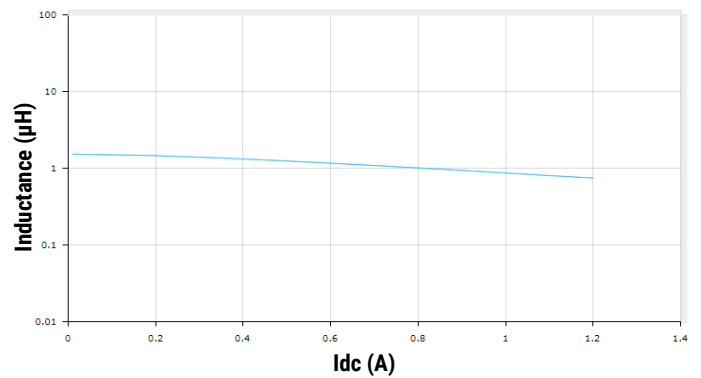

DC-Superposed Characteristics cont.

L0806C2R2M DMIT

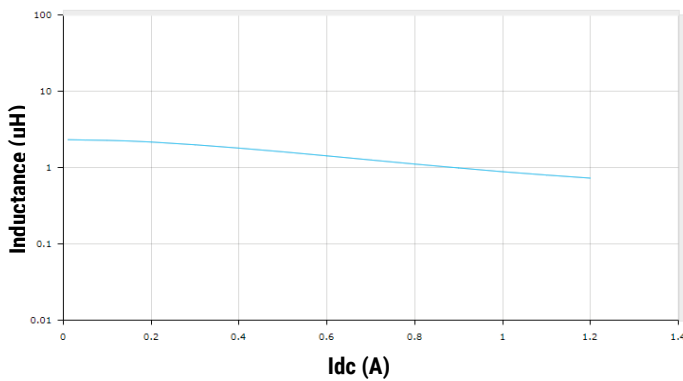

L0806C3R3M DMIT

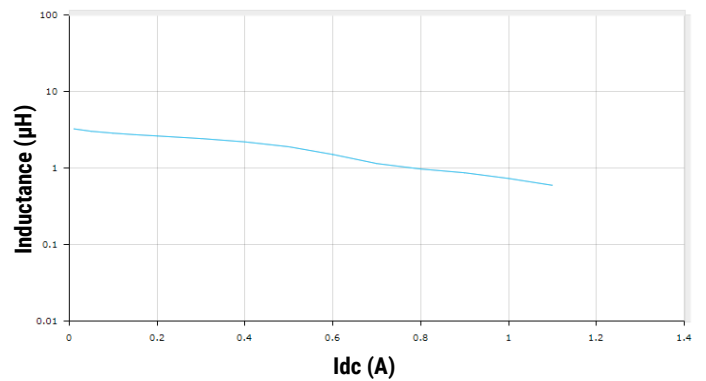

L0806C4R7M DMIT

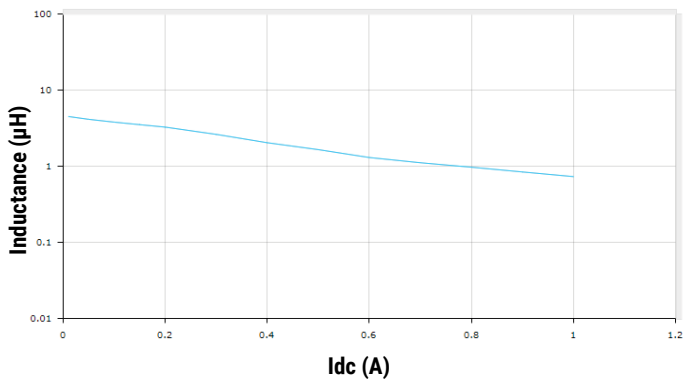

L1008CR47M DMIT

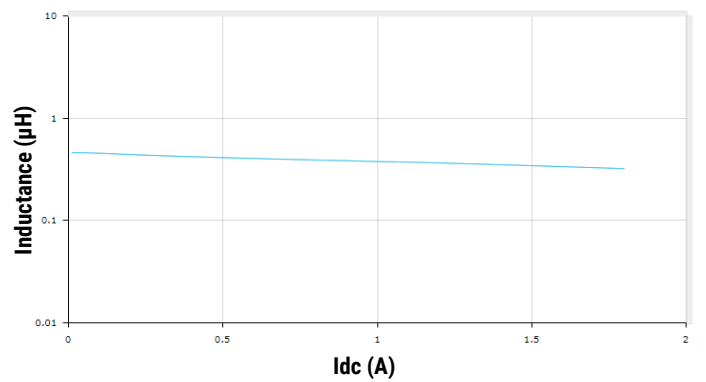

L1008C1R0M DMIT

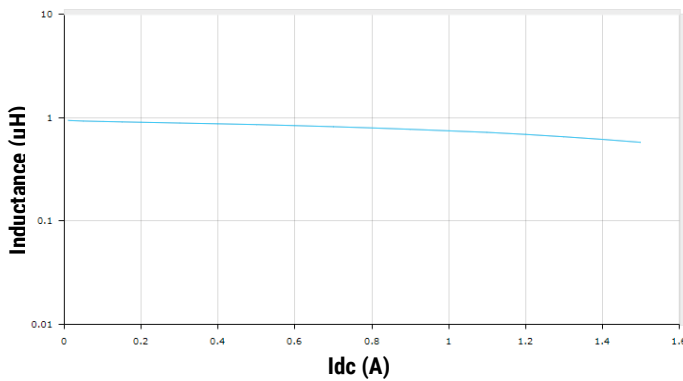

L1008C1R5M DMIT

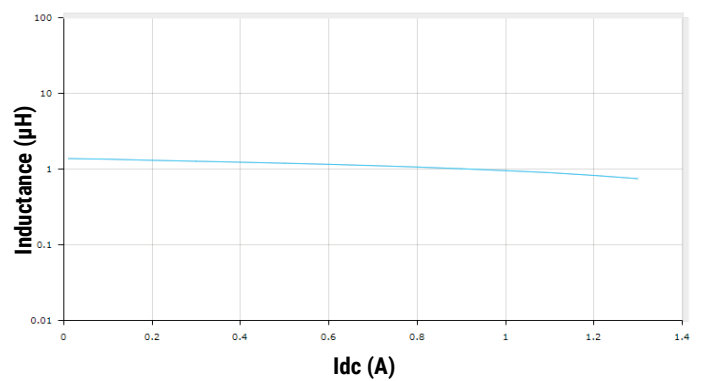

DC-Superposed Characteristics cont.

L1008C2R2MDMIT

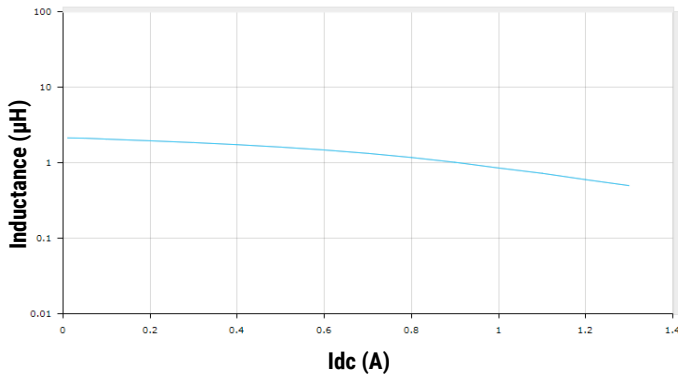

L1008C3R3MDMIT

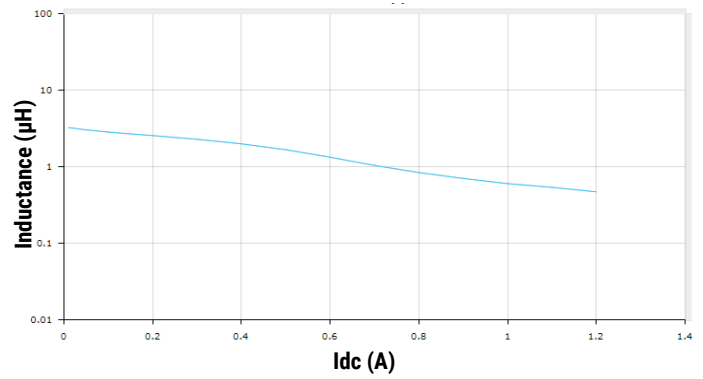

L1008C4R7MDMIT

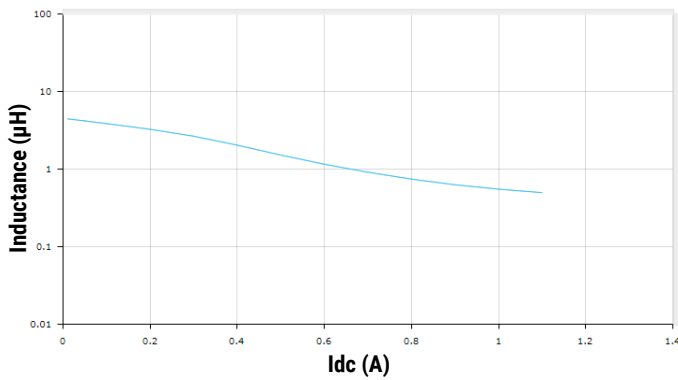

L1008L1R5MDMIT

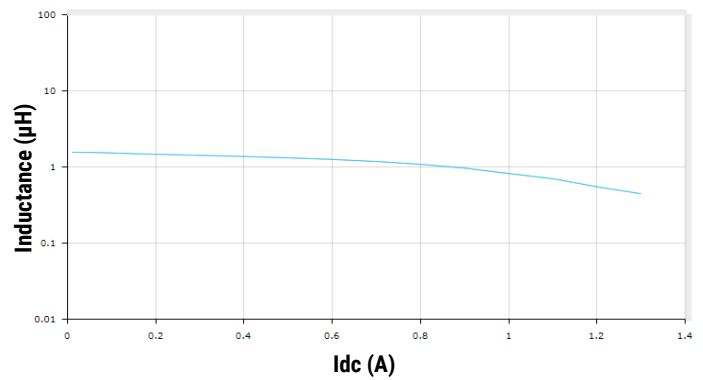

L1008L2R2MDMIT

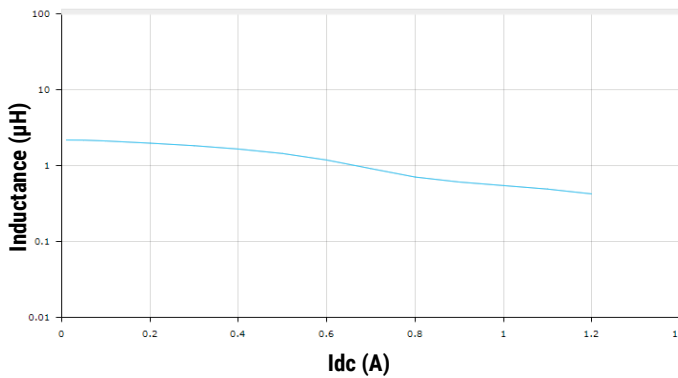

L1008S1R0MDMIT

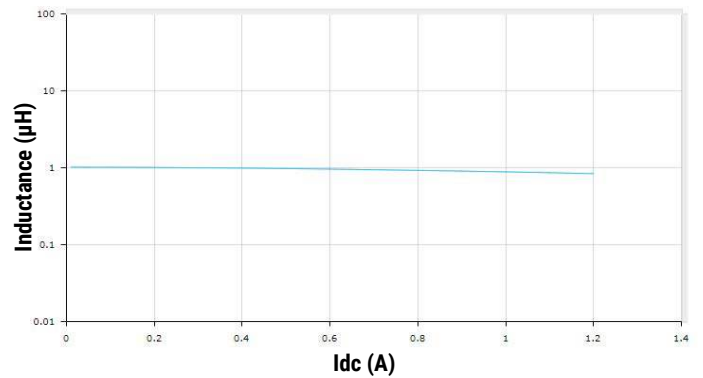

DC-Superposed Characteristics cont.

L1008S2R2MDMIT

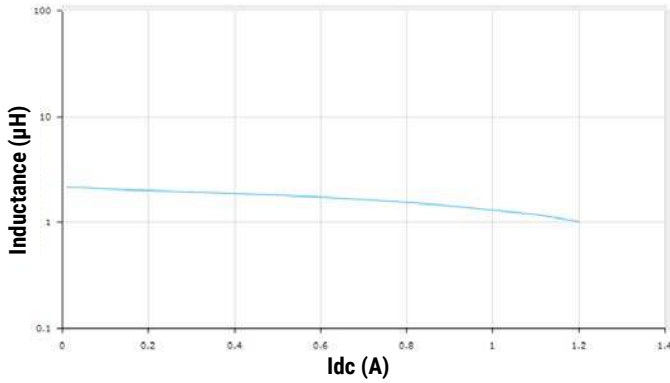

L1008S4R7MDMIT

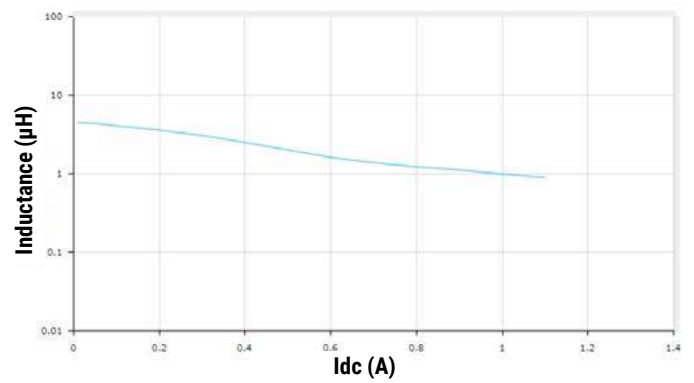

L1008Q1R0MDMIT

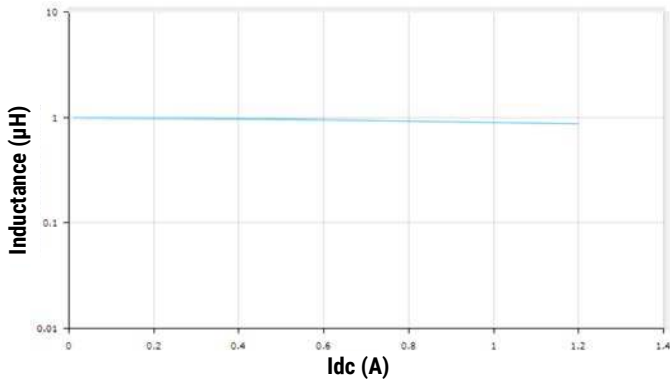

L1008Q2R2MDMIT

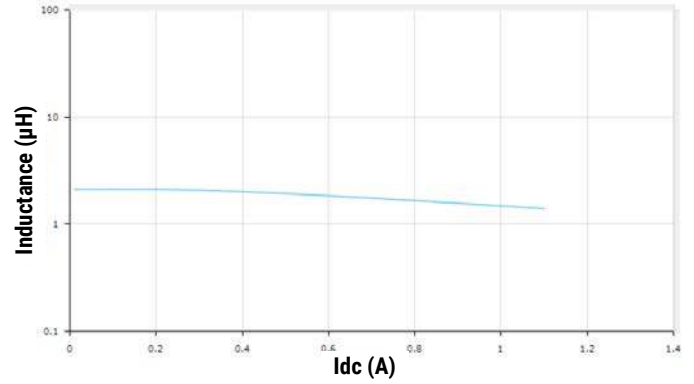

L1008Q3R3MDMIT

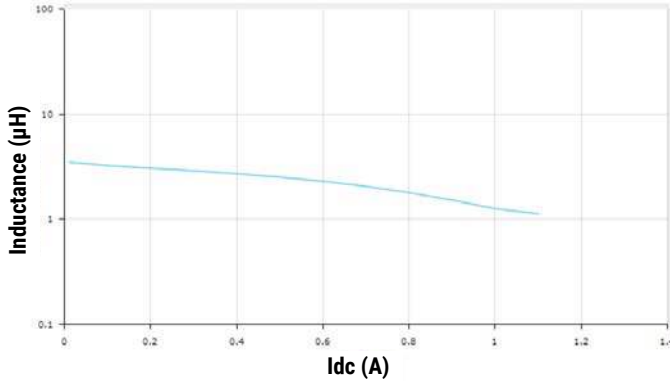

L1008Q4R7MDMIT

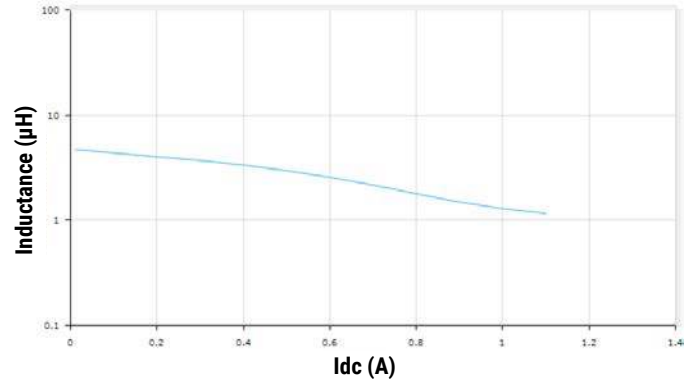

Taping Specifications - Millimeters (Inches)

0603 Paper Tape 8mm Width

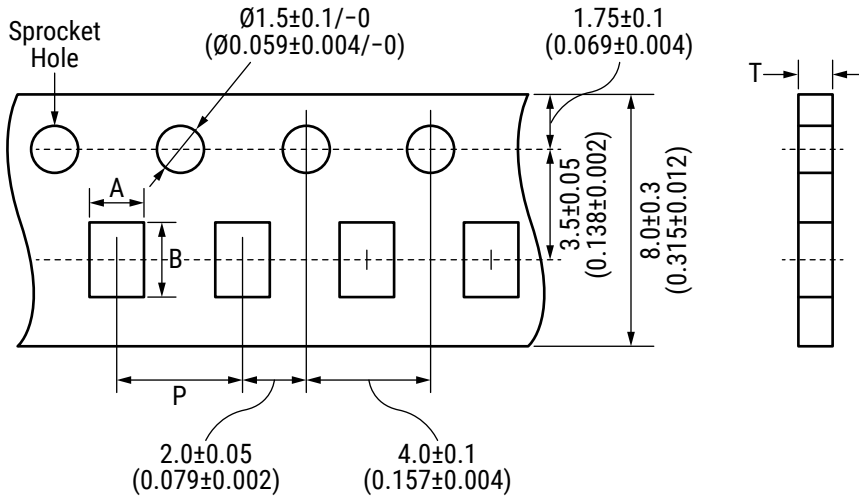

EIA Case Size	Metric Case Size	Height	Reel Quantity		Cavity		Pitch	Thickness
					A	B	P	T
0603	1608	0.8	4,000	Nominal	1.0	1.8	4.0	1.1
				Tolerance	± 0.2	± 0.2	± 0.1	Maximum

Taping Specifications - Millimeters (Inches) cont.

0805, 0806, 1008 Embossed (Plastic) Tape 8mm Width

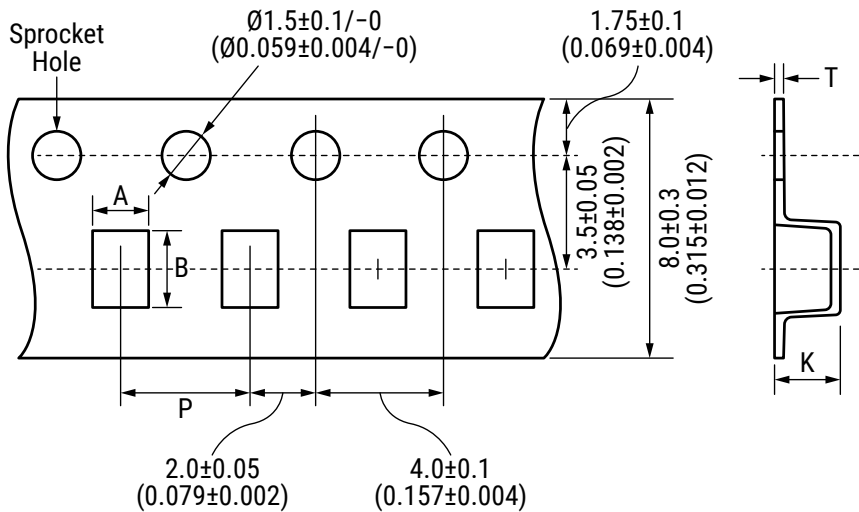

EIA Case Size	Metric Case Size	Height	Reel Quantity		Cavity		Pitch	Thickness	
					A	B	P	T	K
0805	2012	0.9	3,000	Nominal	1.55	2.30	4.00	0.30	1.3
				Tolerance	±0.2	±0.2	±0.1		
0806	2016	0.9	3,000	Nominal	1.80	2.20	4.00	0.25	1.3
				Tolerance	±0.1	±0.1	±0.1		
1008	2520	0.7	3,000	Nominal	2.3	2.8	4	0.30	1.4
		0.9	3,000	Tolerance	±0.1	±0.1	±0.1		
		1.1	2,000	Nominal	2.30	2.80	4.00	0.30	1.7
				Tolerance	±0.1	±0.1	±0.1		

Reel Specifications - Millimeters

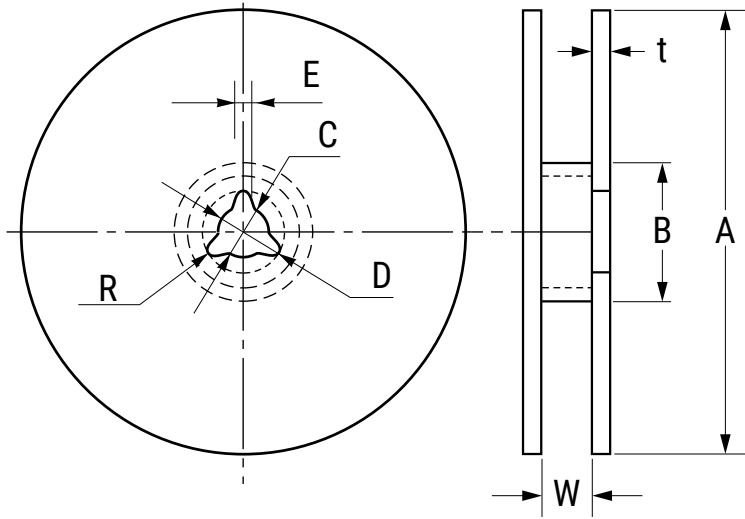

Series		Dimensions - Millimeters							
		A	B	C	D	E	R	t	W
L-DMI	Nominal	ø178.0	ø60.0	ø13.0	ø21.0	2.0	1.0	2.5	10.0
	Tolerance	±2.0	Minimum	±0.2	±0.8	±0.5		Maximum	±1.5

Recommended Reflow Soldering Profile

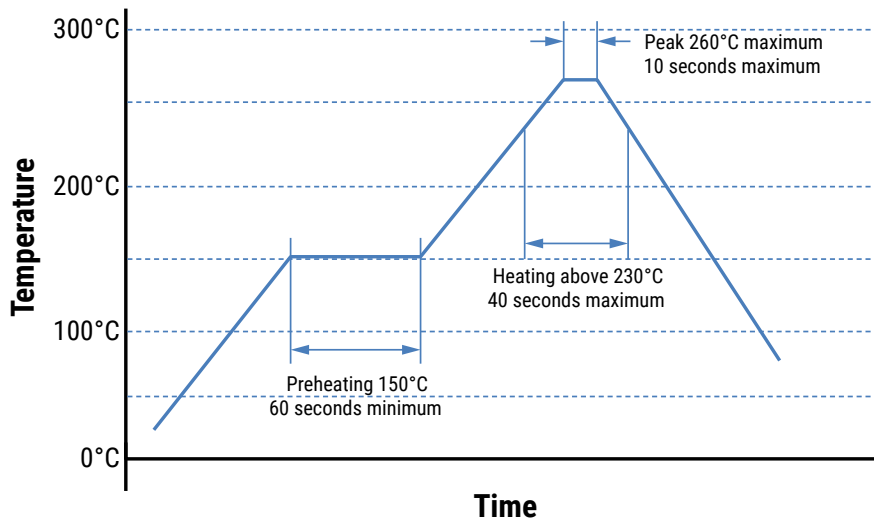

Handling Precautions

Inductors should be stored in normal working environments. While the inductors themselves are quite robust in other environments, exposure to high temperatures, high humidity, corrosive atmospheres, and long-term storage degrades solderability.

KEMET recommends that maximum storage temperature not exceed 40°C and maximum storage humidity not exceed 70% relative humidity. Atmospheres should be free of chlorine-bearing and sulfur-bearing compounds. Temperature fluctuations should be minimized to avoid condensation on the parts.

For optimized solderability, inductor stock should be used promptly, preferably within six months of receipt.

KEMET Electronics Corporation Sales Offices

For a complete list of our global sales offices, please visit www.kemet.com/sales.

Disclaimer

All product specifications, statements, information and data (collectively, the "Information") in this datasheet are subject to change. The customer is responsible for checking and verifying the extent to which the Information contained in this publication is applicable to an order at the time the order is placed. All Information given herein is believed to be accurate and reliable, but it is presented without guarantee, warranty, or responsibility of any kind, expressed or implied.

Statements of suitability for certain applications are based on KEMET Electronics Corporation's ("KEMET") knowledge of typical operating conditions for such applications, but are not intended to constitute – and KEMET specifically disclaims – any warranty concerning suitability for a specific customer application or use. The Information is intended for use only by customers who have the requisite experience and capability to determine the correct products for their application. Any technical advice inferred from this Information or otherwise provided by KEMET with reference to the use of KEMET's products is given gratis, and KEMET assumes no obligation or liability for the advice given or results obtained.

Although KEMET designs and manufactures its products to the most stringent quality and safety standards, given the current state of the art, isolated component failures may still occur. Accordingly, customer applications which require a high degree of reliability or safety should employ suitable designs or other safeguards (such as installation of protective circuitry or redundancies) in order to ensure that the failure of an electrical component does not result in a risk of personal injury or property damage.

Although all product-related warnings, cautions and notes must be observed, the customer should not assume that all safety measures are indicated or that other measures may not be required.

When providing KEMET products and technologies contained herein to other countries, the customer must abide by the procedures and provisions stipulated in all applicable export laws and regulations, including without limitation the International Traffic in Arms Regulations (ITAR), the US Export Administration Regulations (EAR) and the Japan Foreign Exchange and Foreign Trade Act.

KEMET is a registered trademark of KEMET Electronics Corporation.