

4dB Directional Coupler

Xinger III



Description:

The X3C35F1-04S is a low profile, high performance 4dB directional coupler in a new easy to use, manufacturing friendly surface mount package. It is designed for DC, WCDMA, LTE and PCS applications. The X3C35F1-04S is designed particularly for non-binary split and combine in high power amplifiers, e.g. used along with a 3dB to get a 3-way, plus other signal distribution applications where low insertion loss is required. It can be used in high power applications up to 25 Watts.

Parts have been subjected to rigorous qualification testing and they are manufactured using materials with coefficients of thermal expansion (CTE) compatible with common substrates such as FR4, G-10, RF-35, RO4003 and polyimide. Produced with 6 of 6 RoHS compliant tin immersion finish.

Detailed Electrical Specifications:

Features:

- 3100-4200 MHz
- High Power
- Very Low Loss
- Tight Coupling
- High Directivity
- Production Friendly
- Tape and Reel
- Lead Free

Frequency	Mean Coupling	Insertion Loss	VSWR
<i>MHz</i>	<i>dB</i>	<i>dB Max</i>	<i>Max : 1</i>
3300-3800	4.0 ± 0.15	0.20	1.15
3100-4200	4.0 ± 0.30	0.30	1.22
Directivity	Phase Balance	Power	Operating Temp.
<i>dB Min</i>	<i>Degrees Max</i>	<i>Avg. CW Watts @105 °C</i>	<i>°C</i>
20	90 ± 4.0	25	-55 to +150
18	90 ± 4.0	25	-55 to +150

**Specification based on performance of unit properly installed on TTM Technologies Test Board.

*Specifications subject to change without notice. Refer to parameter definitions for details.

Outline Drawing:

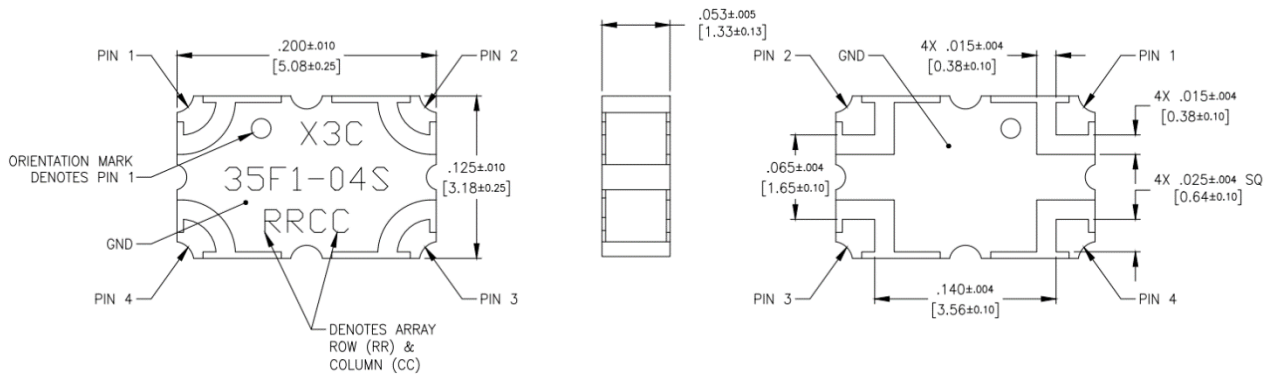

Directional Coupler Pin Configuration

The X3C35F1-04S has an orientation marker to denote Pin 1. Once port one has been identified the other ports are known automatically. Please see the chart below for clarification:

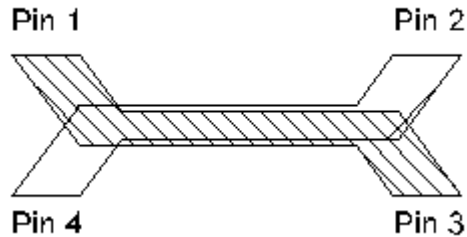

Pin 1	Pin 2	Pin 3	Pin 4
Input	Isolated	Direct	Coupled
Isolated	Input	Coupled	Direct
Direct	Coupled	Input	Isolated
Coupled	Direct	Isolated	Input

Note: The direct port has a DC connection to the input port and the coupled port has a DC connection to the isolated port.

Peak Power Handling

High-Pot testing of these couplers during the qualification procedure resulted in a minimum breakdown voltage of 1.49Kv (minimum recorded value). This voltage level corresponds to a breakdown resistance capable of handling at least 12dB peaks over average power levels, for very short durations. The breakdown location consistently occurred across the air interface at the coupler contact pads (see illustration below). The breakdown levels at these points will be affected by any contamination in the gap area around these pads. These areas must be kept clean for optimum performance. It is recommended that the user test for voltage breakdown under the maximum operating conditions and over worst case modulation induced power peaking. This evaluation should also include extreme environmental conditions (such as high humidity).

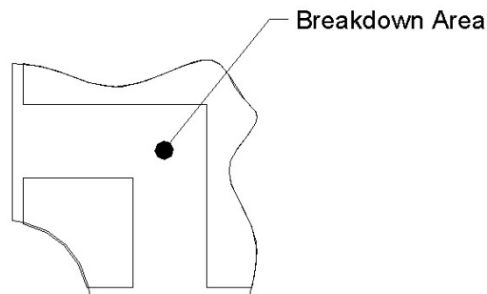

Insertion Loss and Power Derating Curves

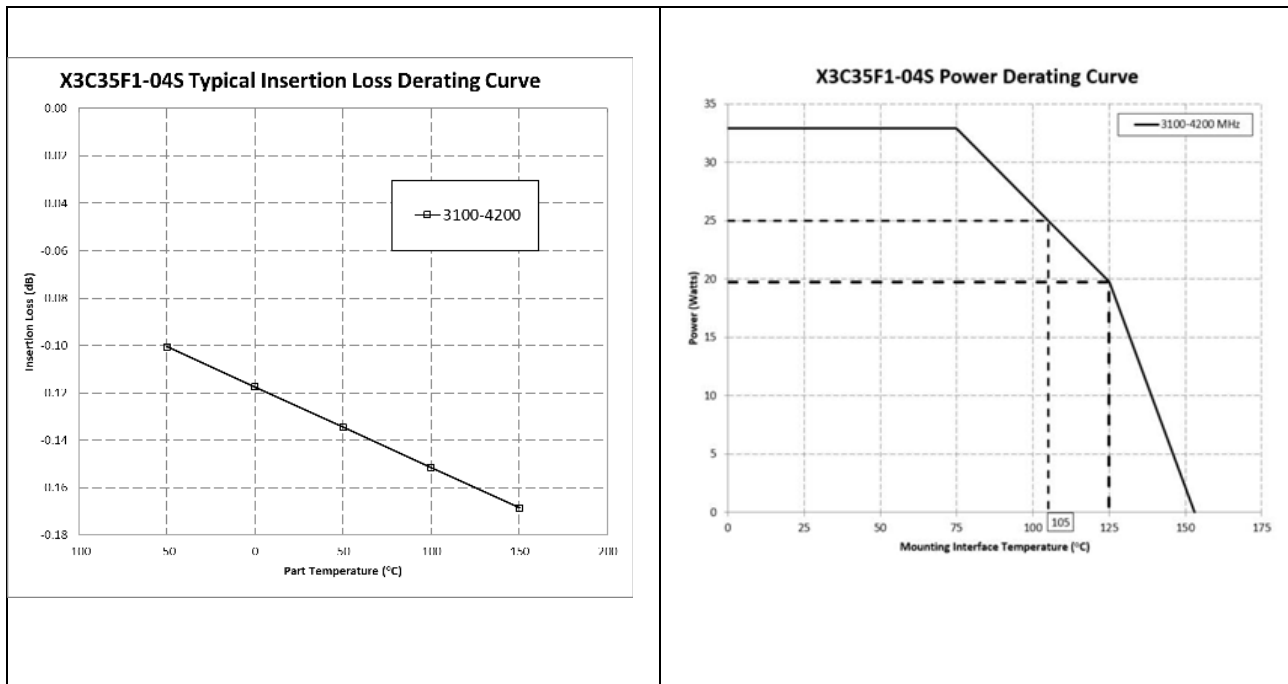

Insertion Loss Derating:

The insertion loss, at a given frequency, of a group of couplers is measured at 25°C and then averaged. The measurements are performed under small signal conditions (i.e. using a Vector Network Analyzer). The process is repeated at -55°C, 95°C and 150°C. A best-fit line for the measured data is computed and then plotted from -55°C to 150°C.

Power Derating:

The power handling and corresponding power derating plots are a function of the thermal resistance, mounting surface temperature (base plate temperature), maximum continuous operating temperature of the coupler, and the thermal insertion loss. The thermal insertion loss is defined in the Power Handling section of the data sheet.

As the mounting interface temperature approaches the maximum continuous operating temperature, the power handling decreases to zero.

If mounting temperature is greater than 95°C, Xinger coupler will perform reliably as long as the input power is derated to the curve above.

Typical Performance (-55°C, 25°C, 95°C, and 140°C) : 3100-4200 MHz

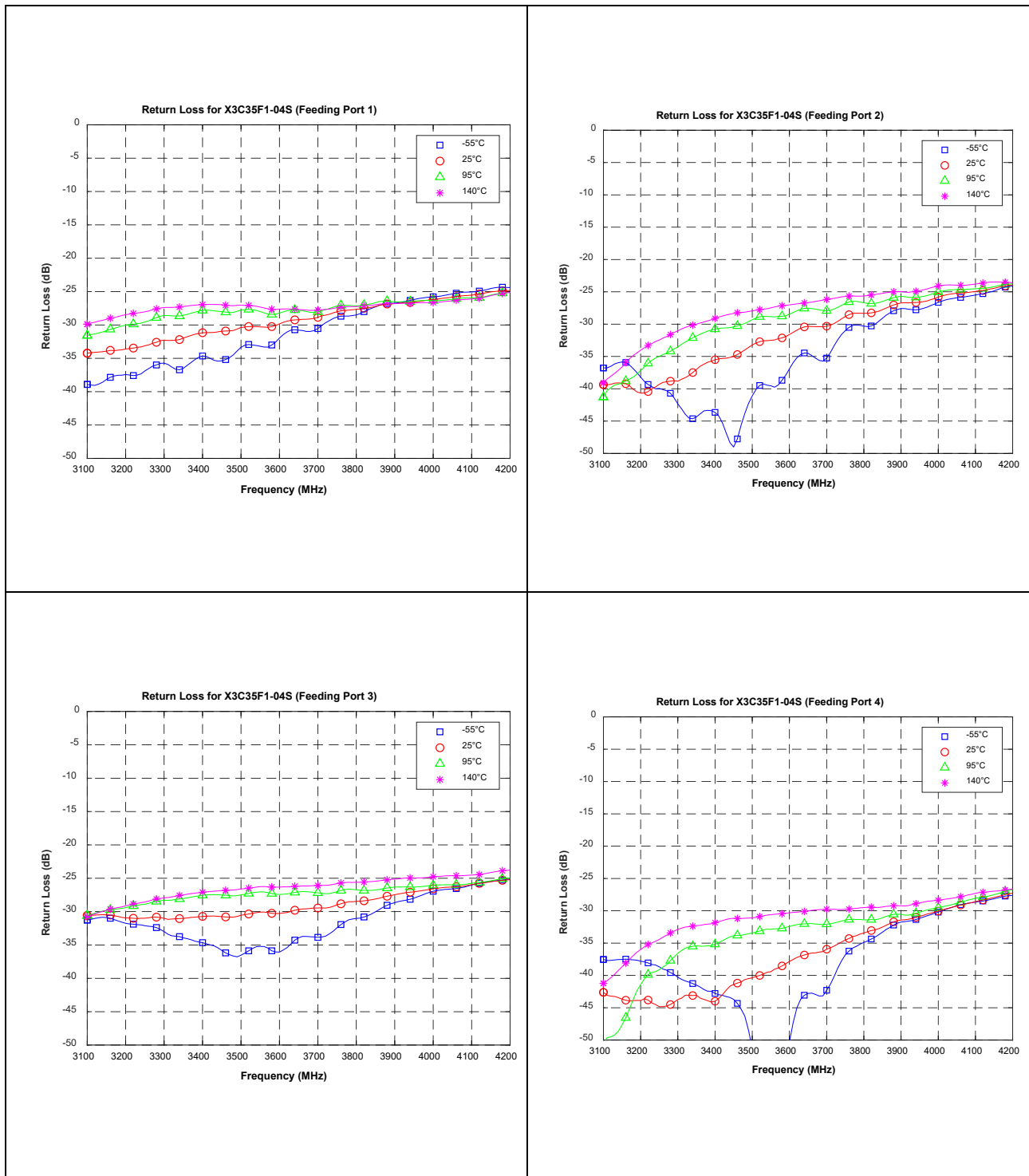

Typical Performance (-55°C, 25°C, 95 and 140°C): 3100-4200 MHz

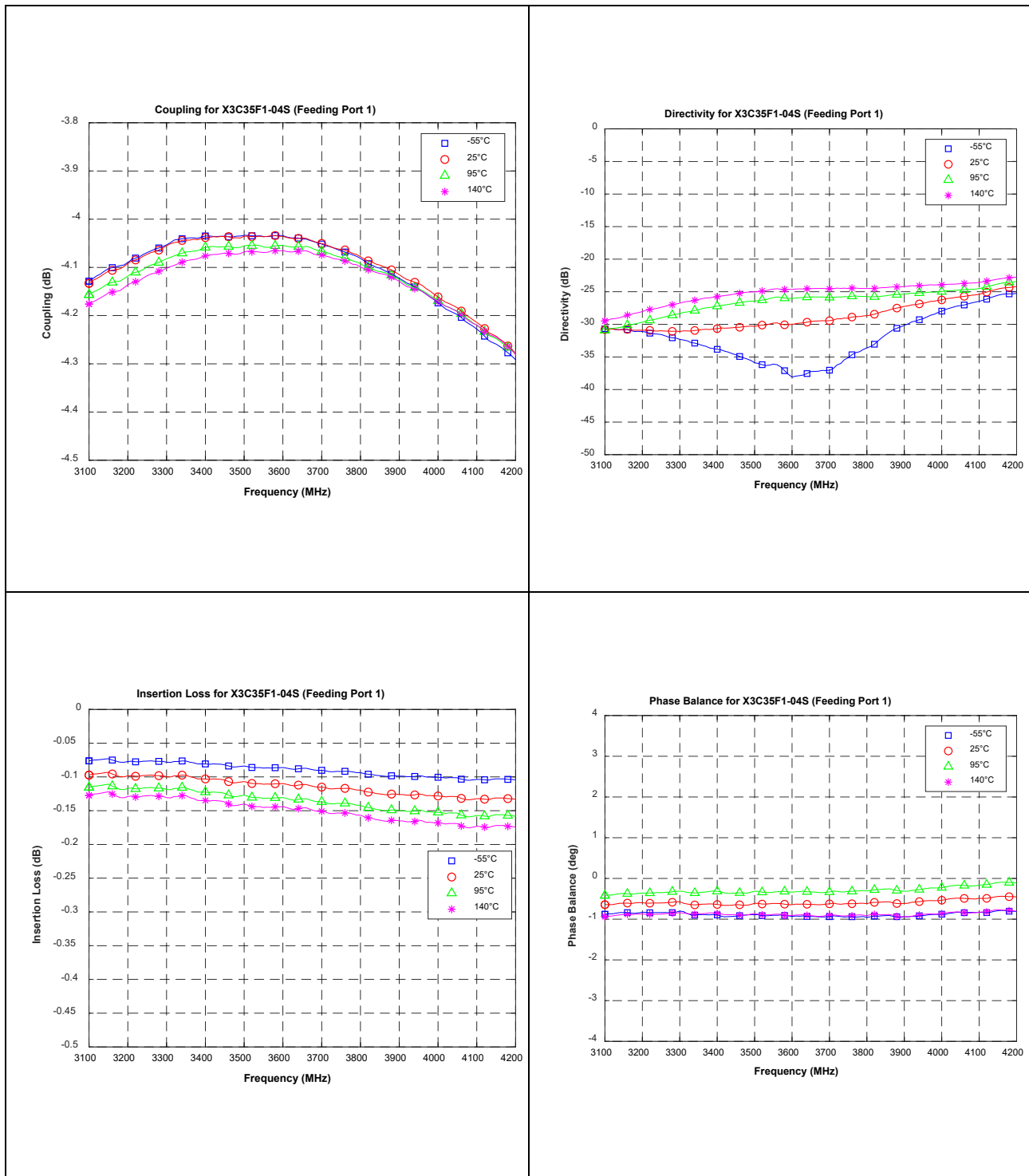

Definition of Measured Specifications

Parameter	Definition	Mathematical Representation
VSWR (Voltage Standing Wave Ratio)	The impedance match of the coupler to a 50Ω system. A VSWR of 1:1 is optimal.	$VSWR = \frac{V_{max}}{V_{min}}$ Vmax = voltage maxima of a standing wave Vmin = voltage minima of a standing wave
Return Loss	The impedance match of the coupler to a 50Ω system. Return Loss is an alternate means to express VSWR.	$\text{Return Loss(dB)} = 20\log \frac{VSWR+1}{VSWR-1}$
Mean Coupling	At a given frequency (ω_n), coupling is the input power divided by the power at the coupled port. Mean coupling is the average value of the coupling values in the band. N is the number of frequencies in the band.	$\text{Coupling(dB)} = C(\omega_n) = 10\log \frac{P_{in}(\omega_n)}{P_{cpl}(\omega_n)}$ $\text{Mean Coupling(dB)} = \frac{\sum_{n=1}^N C(\omega_n)}{N}$
Insertion Loss	The input power divided by the sum of the power at the two output ports.	$\text{Insertion Loss(dB)} = 10\log \frac{P_{in}}{P_{cpl} + P_{direct}}$
Directivity	The power at the coupled port divided by the power at the isolated port.	$10\log \frac{P_{cpl}}{P_{iso}}$
Phase Balance	The difference in phase angle between the two output ports.	Phase at coupled port – Phase at direct port
Frequency Sensitivity	The decibel difference between the maximum in band coupling value and the mean coupling, and the decibel difference between the minimum in band coupling value and the mean coupling.	Max Coupling (dB) – Mean Coupling (dB) and Min Coupling (dB) – Mean Coupling (dB)

Packaging and Ordering Information

Parts are available in reels. Packaging follows EIA 481-D for reels. Parts are oriented in tape and reel as shown below. Tape and reel is available in 4000 pcs per reel.

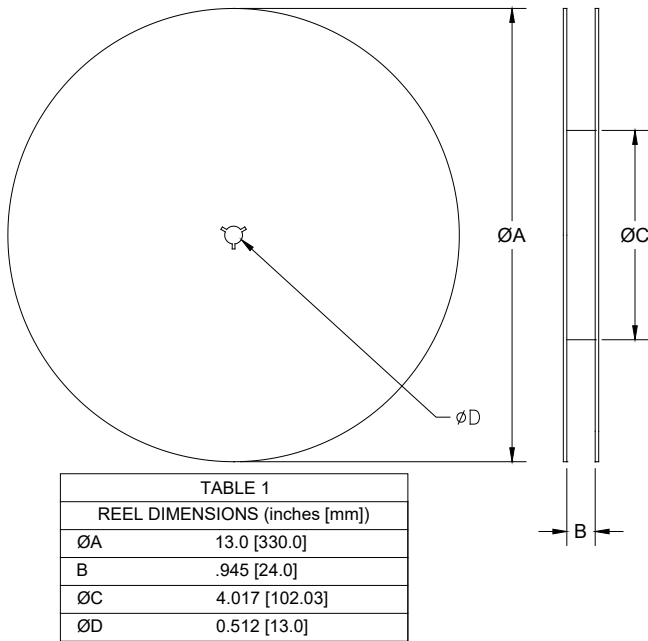
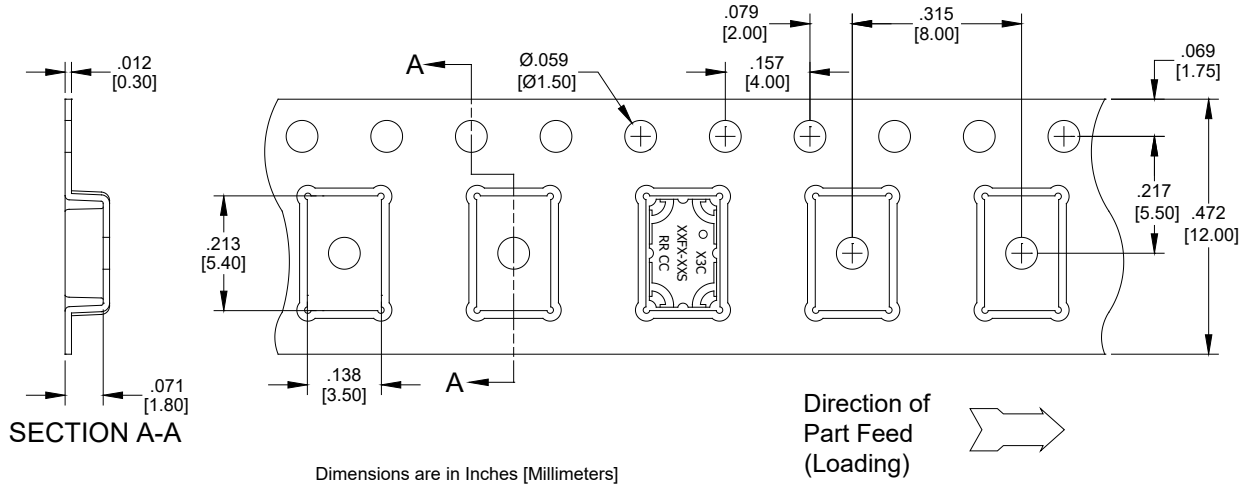

Contact us:
rf&s_support@ttm.com