

6	5	4	3	2	1
APPROVED: _____			Rev	AWO #	Description
DATE: _____ TITLE: _____			-		RELEASED
					Date
					2/9/21
					Appr

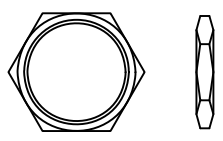

HEX NUT

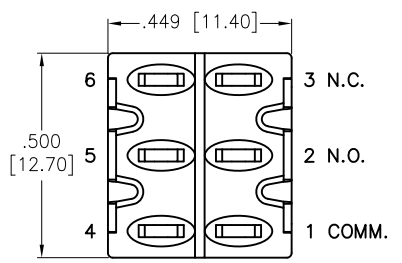
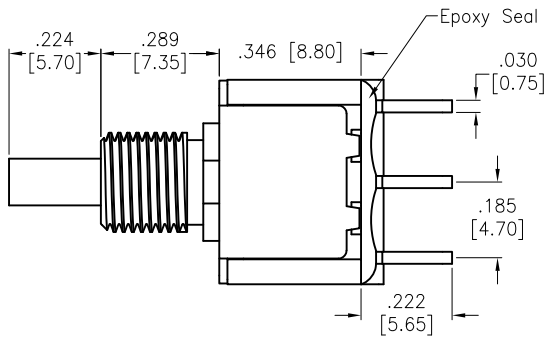
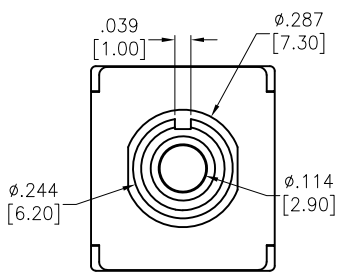
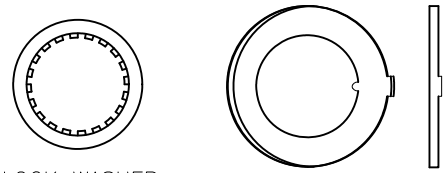

LOCK WASHER

ANTI ROTATIONAL WASHER

INCLUDED HARDWARE

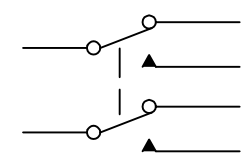
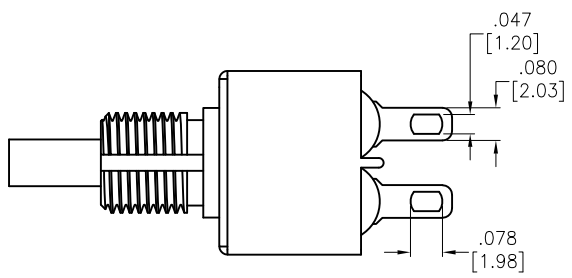

CIRCUIT DIAGRAM
(DPDT) ON-MOMENTARY

SPECIFICATIONS:

Material:
 Movable Contact: Copper Alloy, Silver Plated
 Terminal: Copper Alloy, Silver Plated
 Electrical:
 Voltage rating: 120VAC or 38VDC
 Current rating: 1 Amps
 Contact resistance: 10 mΩ max
 Insulation resistance: 1,000 Mohms min
 Dielectric withstanding voltage: 1,500V RMS @Sea level
 Temperature Rating:
 Operating temperature: -30°C to +85°C
 Environmental:
 Lead free, RoHS compliant



UNLESS OTHERWISE SPECIFIED ALL DIMENSIONS ARE INCHES [MM] TOLERANCES: EXCEPT AS NOTED		
INCHES HOLES		
.X ± .10	∅.X ± .10	
.XX ± .020	∅.XX ± .015	
.XXX ± .015	∅.XXX ± .010	
APPROVALS		DATE
DRAWN	LH	2/9/21
CHECKED	AC	2/9/21
APPROVED		

ADAM TECH 909 Rahway Avenue,
 Union, NJ 07083
 Phone: 908-687-5000
 Fax: 908-687-5710

TITLE: SNAP-ACTING PUSH BUTTON SWITCH, DPDT,
 ON-MOMENTARY, SILVER PLATED, SOLDER TYPE

SIZE X	PART NO. SW-PB8-BB00A1QE-1	REV. -
REF: S00198T	SCALE: NTS	SHEET 1 OF 1