

RECOMMENDED PCB(CONNECTOR SIDE VIEW)
THICKNESS=1.6 TO 2.4 MM

ONLY FOR CKT 6, 10, 14
OTHER DIMENSIONS REFER TO LEFT VIEWS.

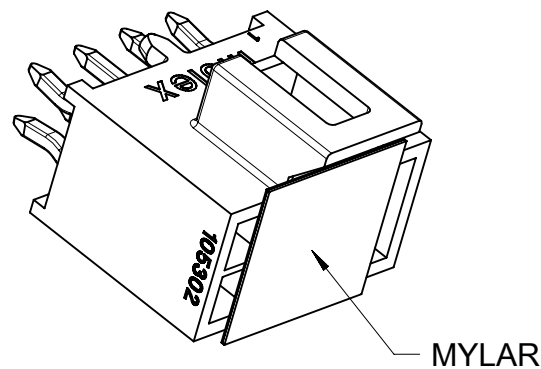

FUNCTIONAL SYMBOLS	THIS DRAWING CONTAINS INFORMATION THAT IS PROPRIETARY TO MOLEX ELECTRONIC TECHNOLOGIES, LLC AND SHOULD NOT BE USED WITHOUT WRITTEN PERMISSION		CURRENT REV DESC:		molex	
	▽A = 0	mm	SCALE	5:1		
▽E = 0	GENERAL TOLERANCES (UNLESS SPECIFIED)				HEADER OF NANO-FIT, D/R, KINK, VERTICAL POWER CONNECTOR	
▽F = 0	ANGULAR TOL ± 3.0°					
DIVISIONAL SYMBOLS	4 PLACES	±	EC NO: 698973	2022/03/07	PRODUCT CUSTOMER DRAWING	
	3 PLACES	± 0.1	DRWN: GLLI	2022/03/11		
	2 PLACES	± 0.2	CHK'D: XQZHANG	2022/03/11	DOCUMENT NUMBER	
	1 PLACE	± 0.3	APPR: XQZHANG	2022/03/11		DOC TYPE
	0 PLACES	±	INITIAL REVISION:			
DRAFT WHERE APPLICABLE MUST REMAIN WITHIN DIMENSIONS		DRWN: GLLI	2019/09/24	REVISION		
THIRD ANGLE PROJECTION		APPR: YXZHENG	2020/03/16		1053101000-SD	
DRAWING		SERIES	MATERIAL NUMBER		CUSTOMER	SHEET NUMBER
A3-SIZE		105310	GENERAL MARKET	PSD 000	B1	
1 OF 5						

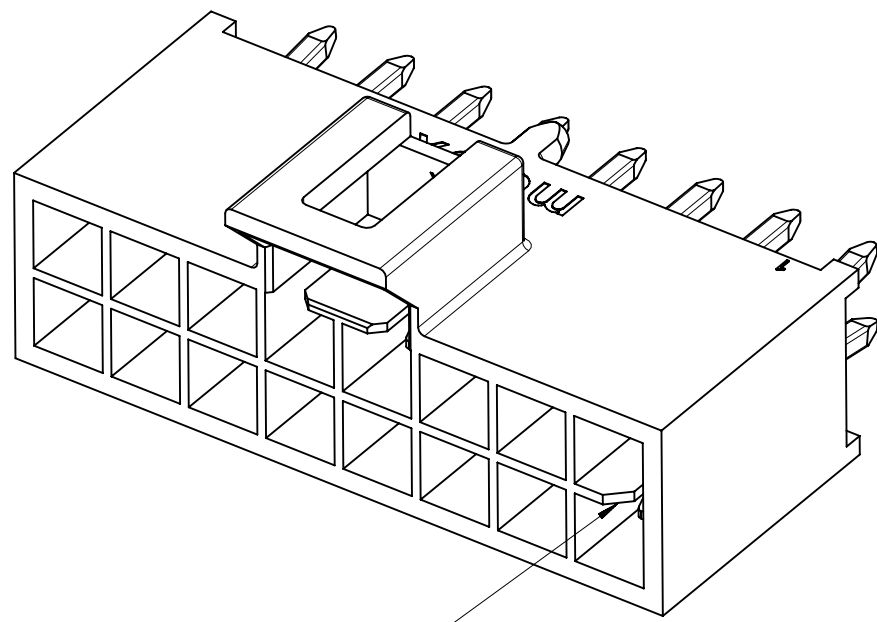

KEY A

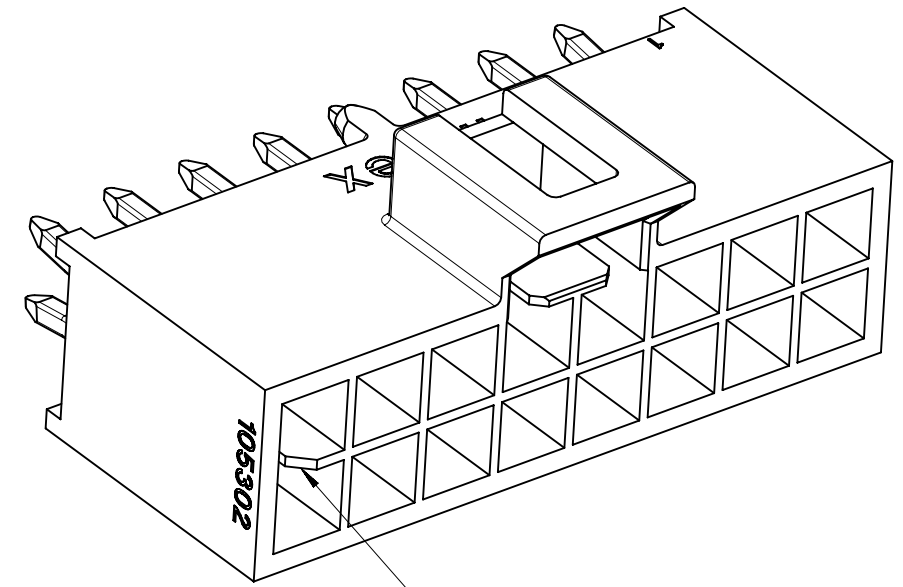

KEY B

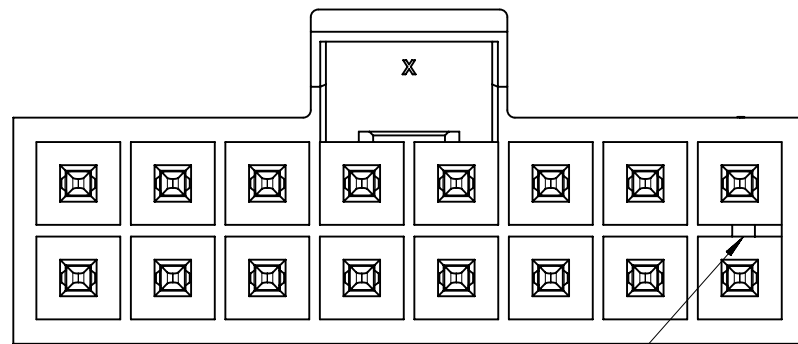

KEY A

BLACK

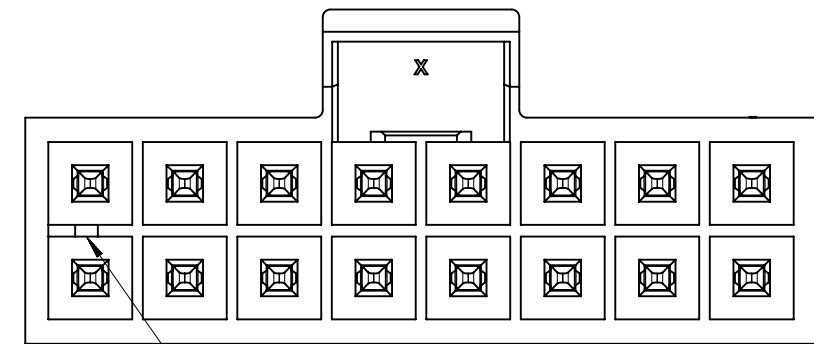

KEY B

NATURAL

COLOR OPTION

FUNCTIONAL SYMBOLS	THIS DRAWING CONTAINS INFORMATION THAT IS PROPRIETARY TO MOLEX ELECTRONIC TECHNOLOGIES, LLC AND SHOULD NOT BE USED WITHOUT WRITTEN PERMISSION		CURRENT REV DESC:		molex				
	$\nabla_A = 0$ $\nabla_E = 0$ $\nabla_F = 0$	DIMENSION UNITS: mm SCALE: 5:1						GENERAL TOLERANCES (UNLESS SPECIFIED) ANGULAR TOL $\pm 3.0^\circ$	
DIVISIONAL SYMBOLS	4 PLACES	\pm	EC NO: 698973	2022/03/07	PRODUCT CUSTOMER DRAWING				
	3 PLACES	± 0.1	DRWN: GLLI	2022/03/11					
	2 PLACES	± 0.2	CHK'D: XQZHANG	2022/03/11	DOCUMENT NUMBER				
	1 PLACE	± 0.3	APPR: XQZHANG	2022/03/11	1053101000-SD		DOC TYPE	DOC PART	REVISION
	0 PLACES	\pm	INITIAL REVISION:		GENERAL MARKET		000	B1	
DRAFT WHERE APPLICABLE MUST REMAIN WITHIN DIMENSIONS		THIRD ANGLE PROJECTION	DRAWING	SERIES	MATERIAL NUMBER	CUSTOMER	SHEET NUMBER		
			A3-SIZE	105310		GENERAL MARKET	2 OF 5		

PART NUMBER	DIM 'A'	DIM 'B'	CKT SIZE	PLATING	MYLAR
105310-3504	5.94	2.50	4	TIN	YES
105310-3506	8.44	5.00	6		
105310-3508	10.94	7.50	8		
105310-3510	13.44	10.00	10		
105310-3512	15.94	12.50	12		
105310-3514	18.44	15.00	14		
105310-3516	20.94	17.50	16		
105310-3704	5.94	2.50	4	GOLD 0.38	YES
105310-3706	8.44	5.00	6		
105310-3708	10.94	7.50	8		
105310-3710	13.44	10.00	10		
105310-3712	15.94	12.50	12		
105310-3714	18.44	15.00	14		
105310-3716	20.94	17.50	16		
105310-3604	5.94	2.50	4	GOLD 0.76	YES
105310-3606	8.44	5.00	6		
105310-3608	10.94	7.50	8		
105310-3610	13.44	10.00	10		
105310-3612	15.94	12.50	12		
105310-3614	18.44	15.00	14		
105310-3616	20.94	17.50	16		
105310-3804	5.94	2.50	4	GOLD 0.76 + LUBE	YES
105310-3806	8.44	5.00	6		
105310-3808	10.94	7.50	8		
105310-3810	13.44	10.00	10		
105310-3812	15.94	12.50	12		
105310-3814	18.44	15.00	14		
105310-3816	20.94	17.50	16		

COLOR: BLACK

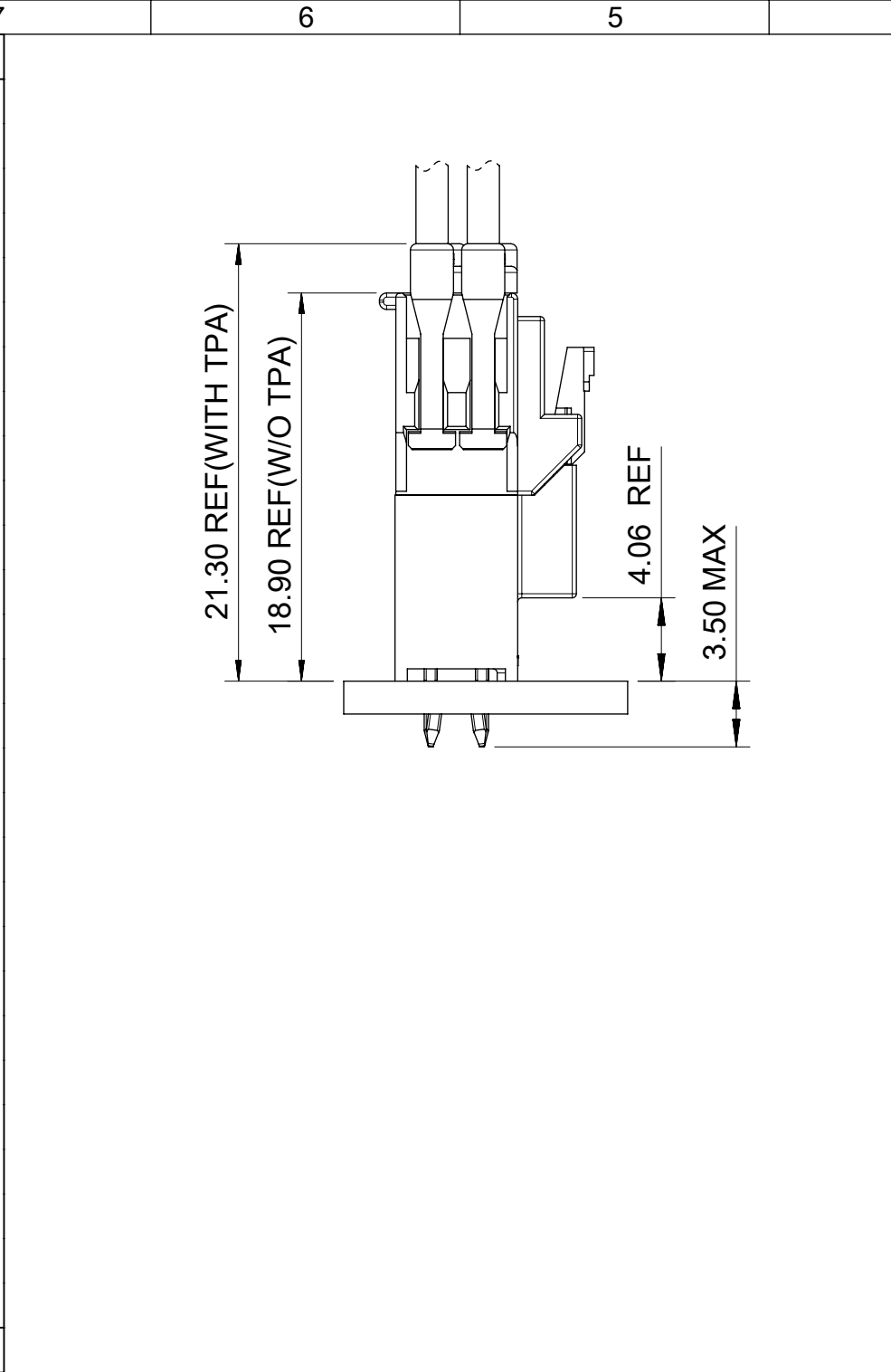

PART NUMBER	DIM 'A'	DIM 'B'	CKT SIZE	PLATING	MYLAR
105310-4504	5.94	2.50	4	TIN	YES
105310-4506	8.44	5.00	6		
105310-4508	10.94	7.50	8		
105310-4510	13.44	10.00	10		
105310-4512	15.94	12.50	12		
105310-4514	18.44	15.00	14		
105310-4704	5.94	2.50	4	GOLD 0.38	YES
105310-4706	8.44	5.00	6		
105310-4708	10.94	7.50	8		
105310-4710	13.44	10.00	10		
105310-4712	15.94	12.50	12		
105310-4714	18.44	15.00	14		
105310-4716	20.94	17.50	16		
105310-4604	5.94	2.50	4	GOLD 0.76	YES
105310-4606	8.44	5.00	6		
105310-4608	10.94	7.50	8		
105310-4610	13.44	10.00	10		
105310-4612	15.94	12.50	12		
105310-4614	18.44	15.00	14		
105310-4616	20.94	17.50	16		
105310-4804	5.94	2.50	4	GOLD 0.76 + LUBE	YES
105310-4806	8.44	5.00	6		
105310-4808	10.94	7.50	8		
105310-4810	13.44	10.00	10		
105310-4812	15.94	12.50	12		
105310-4814	18.44	15.00	14		
105310-4816	20.94	17.50	16		

COLOR: NATURAL

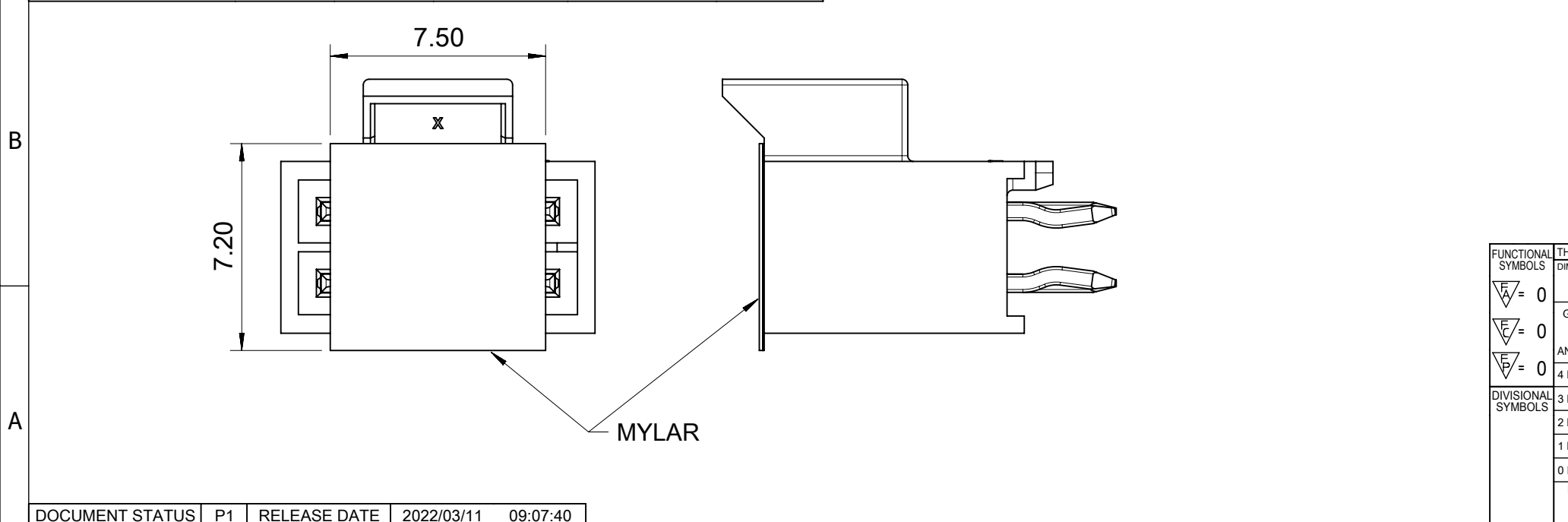

FUNCTIONAL SYMBOLS	THIS DRAWING CONTAINS INFORMATION THAT IS PROPRIETARY TO MOLEX ELECTRONIC TECHNOLOGIES, LLC AND SHOULD NOT BE USED WITHOUT WRITTEN PERMISSION		CURRENT REV DESC:									
	DIMENSION UNITS	SCALE							HEADER OF NANO-FIT, D/R, KINK, VERTICAL POWER CONNECTOR			
△/A = 0	mm	5:1	EC NO: 698973 DRWN: GLLI APPR: XQZHANG 2022/03/11		PRODUCT CUSTOMER DRAWING							
△/E = 0	GENERAL TOLERANCES (UNLESS SPECIFIED)								DOCUMENT NUMBER: 1053101000-SD DOC TYPE: PSD DOC PART: 000 REVISION: B1			
△/V = 0	ANGULAR TOL ± 3.0°											
DIVISIONAL SYMBOLS	4 PLACES	±	THIRD ANGLE PROJECTION 		MATERIAL NUMBER: 105310 CUSTOMER: GENERAL MARKET SHEET NUMBER: 3 OF 5							
	3 PLACES	± 0.1										
	2 PLACES	± 0.2										
	1 PLACE	± 0.3										
	0 PLACES	±	DRAFT WHERE APPLICABLE MUST REMAIN WITHIN DIMENSIONS									

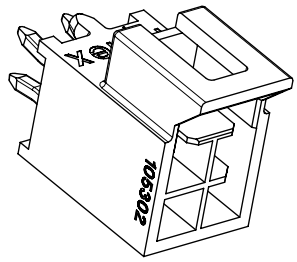
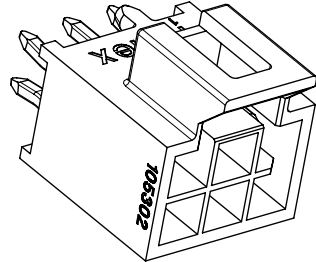
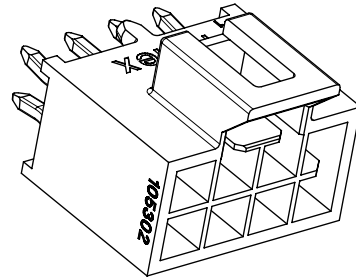
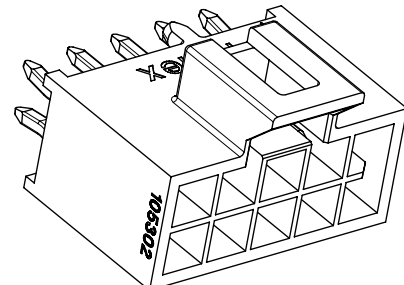
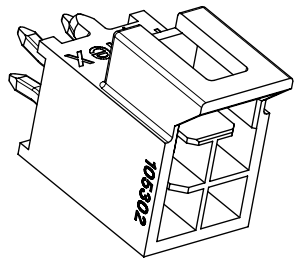
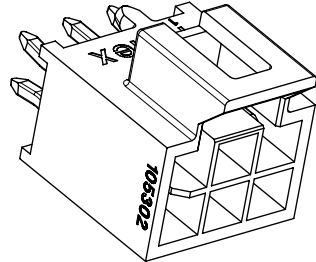
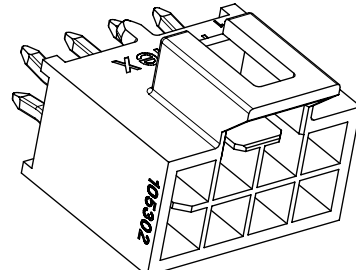
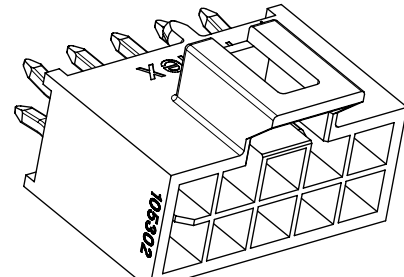
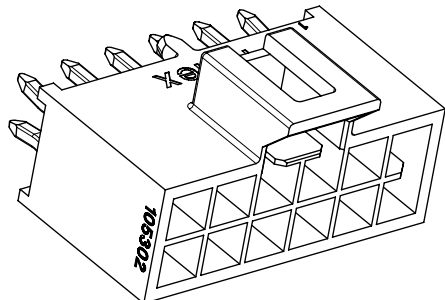
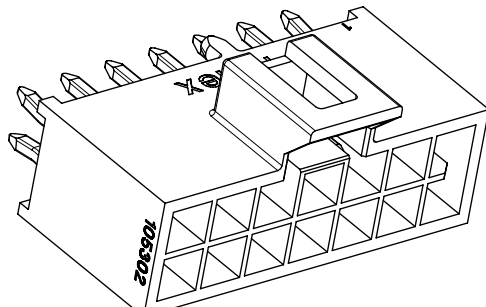
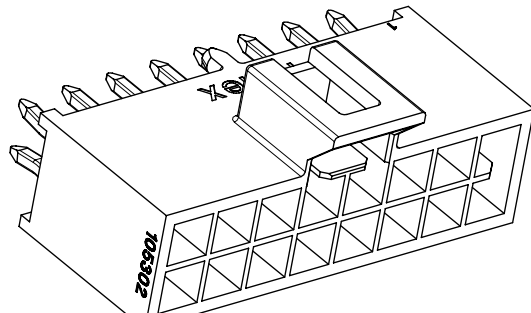
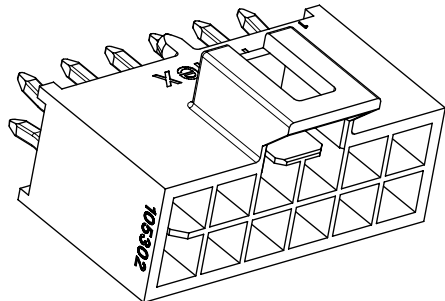
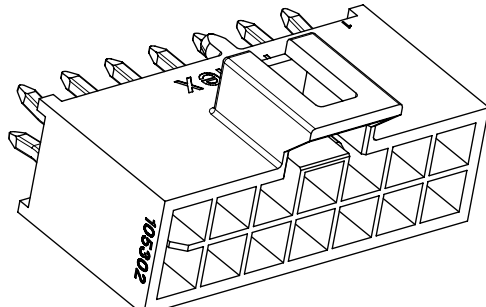
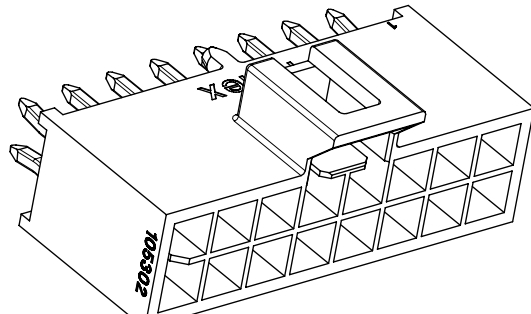
		4 CKT	6 CKT	8 CKT	10 CKT
F	BLACK				
E	NATURAL				
		12 CKT	14 CKT	16 CKT	
D	BLACK				
C	NATURAL				

FUNCTIONAL SYMBOLS	THIS DRAWING CONTAINS INFORMATION THAT IS PROPRIETARY TO MOLEX ELECTRONIC TECHNOLOGIES, LLC AND SHOULD NOT BE USED WITHOUT WRITTEN PERMISSION		CURRENT REV DESC:		molex		
	SCALE	3:1					
DIVISIONAL SYMBOLS	mm		EC NO: 698973 DRWN: GLLI CHK'D: XQZHANG APPR: XQZHANG INITIAL REVISION: DRWN: GLLI APPR: YXZHENG		HEADER OF NANO-FIT, D/R, KINK, VERTICAL POWER CONNECTOR		
	GENERAL TOLERANCES (UNLESS SPECIFIED)						
	ANGULAR TOL ± 3.0°						
	4 PLACES	±					
	3 PLACES	± 0.1					
2 PLACES	± 0.2	2022/03/07		PRODUCT CUSTOMER DRAWING			
1 PLACE	± 0.3	2022/03/11					
0 PLACES	±	2019/09/24		DOCUMENT NUMBER			
DRAFT WHERE APPLICABLE MUST REMAIN WITHIN DIMENSIONS		2020/03/16					1053101000-SD
THIRD ANGLE PROJECTION		DRAWING		PSD 000 B1			
A3-SIZE		SERIES					GENERAL MARKET
		105310		4 OF 5			

NOTES FOR ALL PARTS

1> MATERIAL:
HOUSING: LCP, UL 94V-0; TERMINAL: BRASS.

2> PLATING FINISHED:
TERMINAL:
CONTACT AREA: a. REFLOW MATTE TIN 1.5MICRONS MIN;
b. GOLD 0.38 MICRONS MIN;
c. GOLD 0.76 MICRONS MIN.
SOLDER AREA: MATTE TIN 1.5 MICRONS MIN, UNDER PLATING NICKEL 1.25 MICRONS MIN.

3> PRODUCT SPECIFICATION: PS-105300-100.
4> PACKAGE: TAPE REEL, 1053101000-PK.
5> PRODUCT MATE WITH SERIES OF 105308(RECEPTACLE), 105300(CRIMP TERMINAL).
6> PARTS CONFORM TO CLASS 'B'REQUIREMENTS OF COSMETIC SPECIFICATION PS-45499-002.
7> DISCOLORATION IN THE BANDOLIER PIN CARRIER AREA OF THE PIN IS INHERENT TO THE PLATING PROCESS AND IS DUE TO THE MASKING DEFECT OF THE CARRIER, THIS DISCOLORATION IS IN A NON-FUNCTION AREA OF THE PIN AND WILL NOT AFFECT THE PERFORMANCE OF THE HEADER ASSEMBLY.

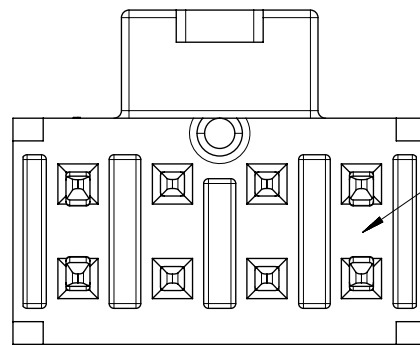

IF ANY NUMBER MARK APPEARS ON THIS SURFACE, PLEASE DISREGARD IT, IT IS NO ANY FUCTION AND NO ANY RELATION TO PIN NUMBER, IT IS JUST FOR MOLDING IDENDIFICATION.

FUNCTIONAL SYMBOLS	THIS DRAWING CONTAINS INFORMATION THAT IS PROPRIETARY TO MOLEX ELECTRONIC TECHNOLOGIES, LLC AND SHOULD NOT BE USED WITHOUT WRITTEN PERMISSION		CURRENT REV DESC:		molex			
	mm	1:1						
GENERAL TOLERANCES (UNLESS SPECIFIED)	ANGULAR TOL ± 3.0°		EC NO: 698973		HEADER OF NANO-FIT, D/R, KINK, VERTICAL POWER CONNECTOR			
4 PLACES ±			DRWN: GLLI 2022/03/07					
DIVISIONAL SYMBOLS	3 PLACES ± 0.1	CHK'D: XQZHANG 2022/03/11		PRODUCT CUSTOMER DRAWING				
2 PLACES ± 0.2	APPR: XQZHANG 2022/03/11		INITIAL REVISION:		DOCUMENT NUMBER	DOC TYPE	DOC PART	REVISION
1 PLACE ± 0.3	DRWN: GLLI 2019/09/24		APPR: YXZHENG 2020/03/16		1053101000-SD	PSD	000	B1
0 PLACES ±	DRAFT WHERE APPLICABLE MUST REMAIN WITHIN DIMENSIONS		THIRD ANGLE PROJECTION	DRAWING	SERIES	MATERIAL NUMBER	CUSTOMER	SHEET NUMBER
				A3-SIZE	105310		GENERAL MARKET	5 OF 5