



# LUXEON UV FC Line

Unique LED enabling limitless design freedom

With FlipChip platform technology, the LUXEON UV FC Line is the smallest and highest power density ( $W/cm^2$ ) ultraviolet LED with FlipChip Technology in a Chip Scale Package (CSP). The LED can be reflowed onto a substrate with standard surface mount (SMT) equipment and process. LUXEON UV FC Line LEDs enable tighter beam control and high packing density of LEDs on a chip on board solution and completely eliminate wire bonds in the system. LUXEON UV FC Line is the ideal choice for cost sensitive applications to achieve high irradiance at high current density, maximizing W/\$ by taking advantage of lowest thermal resistance of a CSP device.



## FEATURES AND BENEFITS

- Ultraviolet wavelength range of 380nm to 420nm for a range of options
- Micro sized CSP:  $1.0mm^2$  package for design flexibility and packing density
- No wire bonds allows for direct attach and reflow
- 5-sided emitter with batwing radiation pattern
- Low thermal resistance for leading system level W/\$
- Maximum drive current of  $1A/mm^2$  delivers superior flux for reduced LED count

## PRIMARY APPLICATIONS

- Specialty Lighting
  - Analytical Instrumentation
  - Curing
  - Medical
  - Security

# Table of Contents

<b>General Product Information</b> .....	<b>2</b>
Product Test Conditions .....	2
Part Number Nomenclature .....	2
Lumen Maintenance .....	2
Environmental Compliance .....	2
<b>Performance Characteristics</b> .....	<b>3</b>
Product Selection Guide .....	3
Optical Characteristics .....	3
Electrical and Thermal Characteristics .....	3
Absolute Maximum Ratings .....	4
<b>Characteristic Curves</b> .....	<b>4</b>
Spectral Power Distribution Characteristics .....	4
<b>Light Output Characteristics</b> .....	<b>5</b>
Forward Current Characteristics .....	6
Wavelength Shift .....	7
Radiation Pattern Characteristics .....	8
<b>Product Bin and Labeling Definitions</b> .....	<b>9</b>
Decoding Product Bin Labeling .....	9
Radiometric Power Bins .....	10
Peak Wavelength Bins .....	10
<b>Forward Voltage Bins</b> .....	<b>11</b>
<b>Mechanical Dimensions</b> .....	<b>11</b>
<b>Reflow Soldering Guidelines</b> .....	<b>12</b>
JEDEC Moisture Sensitivity .....	12
Solder Pad Design .....	13
<b>Packaging Information</b> .....	<b>14</b>
Pocket Tape Dimensions .....	14
Reel Dimensions .....	14

# General Product Information

## Product Test Conditions

LUXEON UV FC Line LEDs are tested and binned with a DC drive current of 500mA at a junction temperature,  $T_j$ , of 25°C.

## Part Number Nomenclature

Part numbers for LUXEON UV FC Line follow the convention below:

L **A** F 3 – U **B B B C** 0 0 0 **D D D D** 1

Where:

- A** – designates packing type (1=tape and reel)
- B B B** – designates minimum peak wavelength (380=380nm, 390=390nm, 400=400nm, 410=410nm)
- C** – designates product name and die size (1=LUXEON UV FC with 1mm<sup>2</sup> die size)
- D D D D** – designates radiometric power (0300=300mW, 0350=350mW, 0400=400mW, 0450=450mW, 1400=1400mW, 1600=1600mW, etc.)

Therefore, the following part number is used for a LUXEON UV FC, with a 1mm<sup>2</sup> die, minimum peak wavelength of 390nm and a radiometric power of 400mW on tape and reel:

L **1** F 3 – U **3 9 0 1** 0 0 0 **0 4 0 0** 1

## Lumen Maintenance

Please contact your local Sales Representative or Lumileds Technical Solutions Manager for more information about the long-term performance of this product.

## Environmental Compliance

Lumileds LLC is committed to providing environmentally friendly products to the solid-state lighting market. LUXEON UV FC Line is compliant to the European Union directives on the restriction of hazardous substances in electronic equipment, namely the RoHS Directive 2011/65/EU and REACH Regulation (EC) 1907/2006. Lumileds LLC will not intentionally add the following restricted materials to its products: lead, mercury, cadmium, hexavalent chromium, polybrominated biphenyls (PBB) or polybrominated diphenyl ethers (PBDE).

# Performance Characteristics

## Product Selection Guide

Table 1. Product performance of LUXEON UV FC Line at 500mA and 1000mA,  $T_j=25^\circ\text{C}$ .

PEAK WAVELENGTH <sup>[1]</sup> (nm)	TYPICAL RADIOMETRIC POWER <sup>[2]</sup> (mW)		PART NUMBER
	500mA	1000mA	
410–420	750	1417	LxF3-U410100007001
400–410	750	1417	LxF3-U400100007001
390–400	750	1417	LxF3-U390100007001
380–390	450	850	LxF3-U380100004001

Notes for Table 1:

1. Lumileds maintains a tolerance of  $\pm 2\text{nm}$  for peak wavelength measurements.
2. Lumileds maintains a tolerance of  $\pm 10\%$  for radiometric power measurements.

## Optical Characteristics

Table 2. Optical characteristics for LUXEON UV FC Line at 500mA,  $T_j=25^\circ\text{C}$ .

PART NUMBER	TYPICAL SPECTRAL HALF-WIDTH (nm)	TYPICAL TEMPERATURE COEFFICIENT OF PEAK WAVELENGTH (nm/ $^\circ\text{C}$ )	TYPICAL TOTAL INCLUDED ANGLE <sup>[1]</sup>	TYPICAL VIEWING ANGLE <sup>[2]</sup>
LxF3-U410x000xxxx1	13.7	0.05	170°	140°
LxF3-U400x000xxxx1	12.0	0.05	170°	140°
LxF3-U390x000xxxx1	11.0	0.05	170°	140°
LxF3-U380x000xxxx1	9.0	0.05	170°	140°

Notes for Table 2:

1. Total angle at which 90% of total luminous flux is captured.
2. Viewing angle is the off axis angle from the LED centerline where the luminous intensity is  $\frac{1}{2}$  of the peak value.

## Electrical and Thermal Characteristics

Table 3. Electrical and thermal characteristics for LUXEON UV FC Line at 500mA,  $T_j=25^\circ\text{C}$ .

PART NUMBER	FORWARD VOLTAGE <sup>[1]</sup> ( $V_f$ )			TYPICAL TEMPERATURE COEFFICIENT OF FORWARD VOLTAGE <sup>[2]</sup> (mV/ $^\circ\text{C}$ )	TYPICAL THERMAL RESISTANCE—JUNCTION TO SOLDER PAD ( $^\circ\text{C}/\text{W}$ )
	MINIMUM	TYPICAL	MAXIMUM		
LxF3-U41010000xxxx1	2.8	3.1	3.4	-2.0 to -3.0	2.0
LxF3-U40010000xxxx1	2.8	3.1	3.4	-2.0 to -3.0	2.0
LxF3-U39010000xxxx1	2.8	3.1	3.4	-2.0 to -3.0	2.0
LxF3-U38010000xxxx1	2.8	3.2	3.4	-2.0 to -3.0	2.0

Notes for Table 3:

1. Lumileds maintains a tolerance of  $\pm 0.05\text{V}$  on forward voltage measurements.
2. Measured between  $25^\circ\text{C}$  and  $85^\circ\text{C}$ .

# Absolute Maximum Ratings

Table 4. Absolute maximum ratings for LUXEON UV FC Line.

PARAMETER	MAXIMUM PERFORMANCE
DC Forward Current <sup>(1,2)</sup>	1000mA
Peak Pulsed Forward Current <sup>(1,3)</sup>	1300mA
LED Junction Temperature <sup>(1)</sup> (DC & Pulse)	120°C
ESD Sensitivity (ANSI/ESDA/JEDEC JS-001-2012)	Class 0B
Operating Case Temperature <sup>(1)</sup>	-40°C to 120°C
LED Storage Temperature	-40°C to 135°C
Soldering Temperature	300 ±3°C <sup>(4)</sup>
Allowable Reflow Cycles	3
Reverse Voltage ( $V_{reverse}$ )	LUXEON UV FC Line LEDs are not designed to be driven in reverse bias

**Notes for Table 4:**

- Proper current derating must be observed to maintain the junction temperature below the maximum allowable junction temperature.
- Residual periodic variations due to power conversion from alternating current (AC) to direct current (DC), also called "ripple," are acceptable if the following conditions are met:
  - The frequency of the ripple current is 100Hz or higher
  - The average current for each cycle does not exceed the maximum allowable DC forward current
  - The maximum amplitude of the ripple does not exceed 15% of the maximum allowable DC forward current
- At 10% duty cycle with pulse width of 10ms.
- 300°C for AuSn (gold-tin) solder system, see [AB116](#) for more details; 260°C for non-AuSn lead-free solder system per JEDEC J-STD-020E classification.

## Characteristic Curves

### Spectral Power Distribution Characteristics

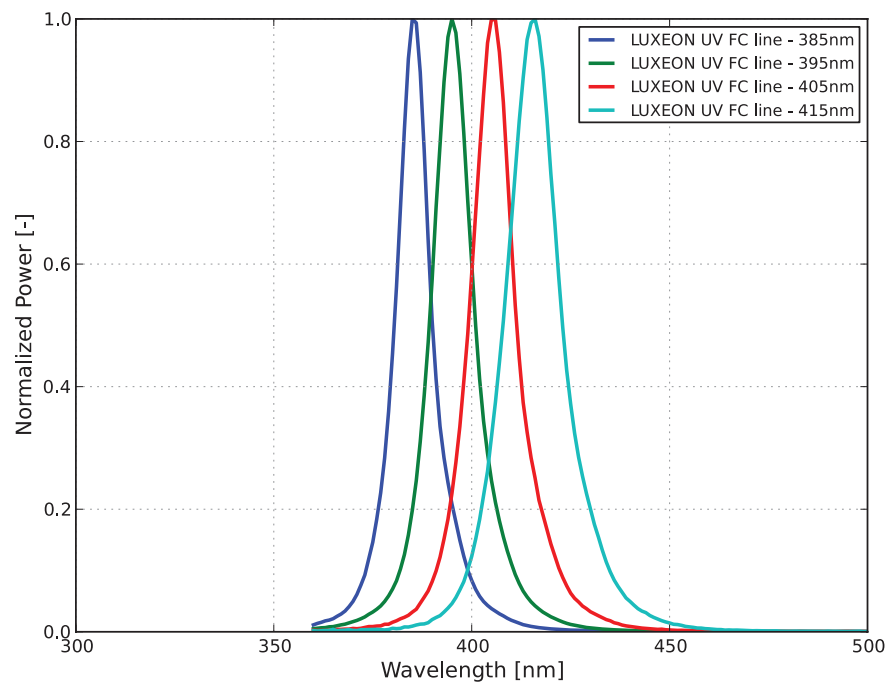

Figure 1. Typical normalized radiant power vs. wavelength for LUXEON UV FC Line at 500mA,  $T_j=25^\circ\text{C}$ .

# Light Output Characteristics

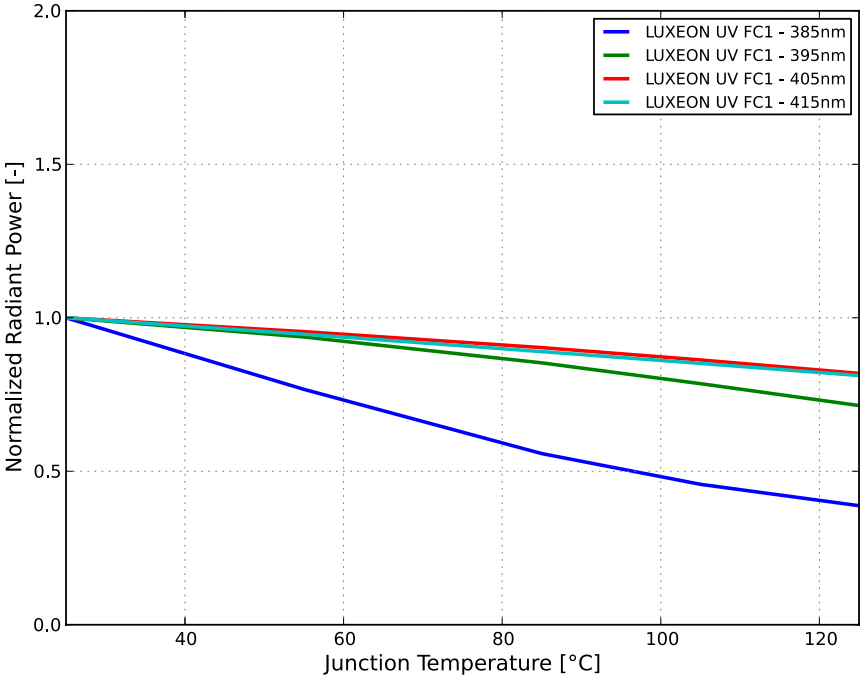

Figure 2. Typical normalized radiant power vs. junction temperature for LUXEON UV FC Line at 500mA.

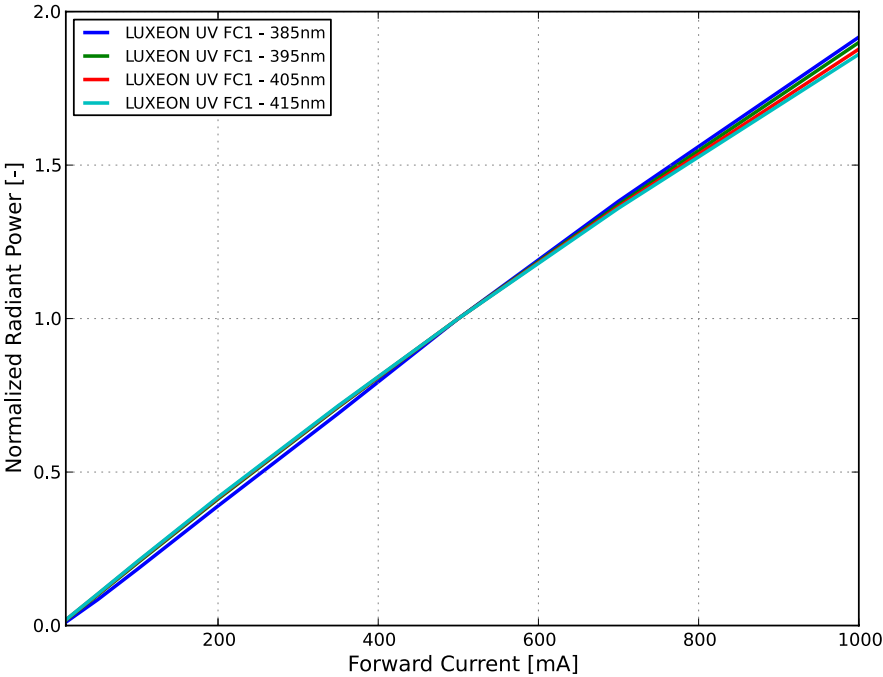

Figure 3. Typical normalized radiant power vs. forward current for LUXEON UV FC Line at T<sub>j</sub>=25°C.

# Forward Current Characteristics

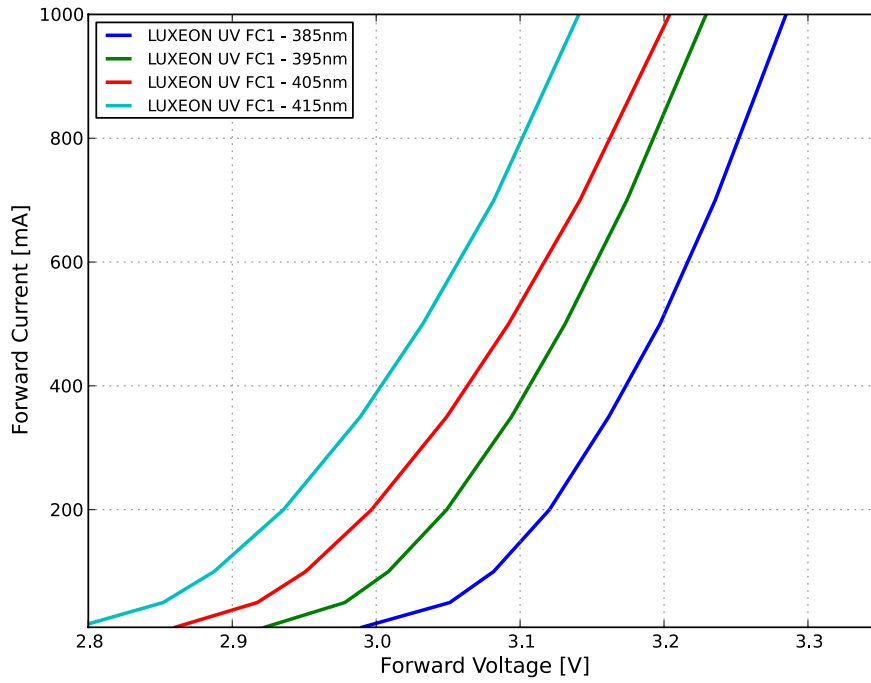

Figure 4. Typical forward current vs. forward voltage for LUXEON UV FC Line at  $T_j=25^\circ\text{C}$ .

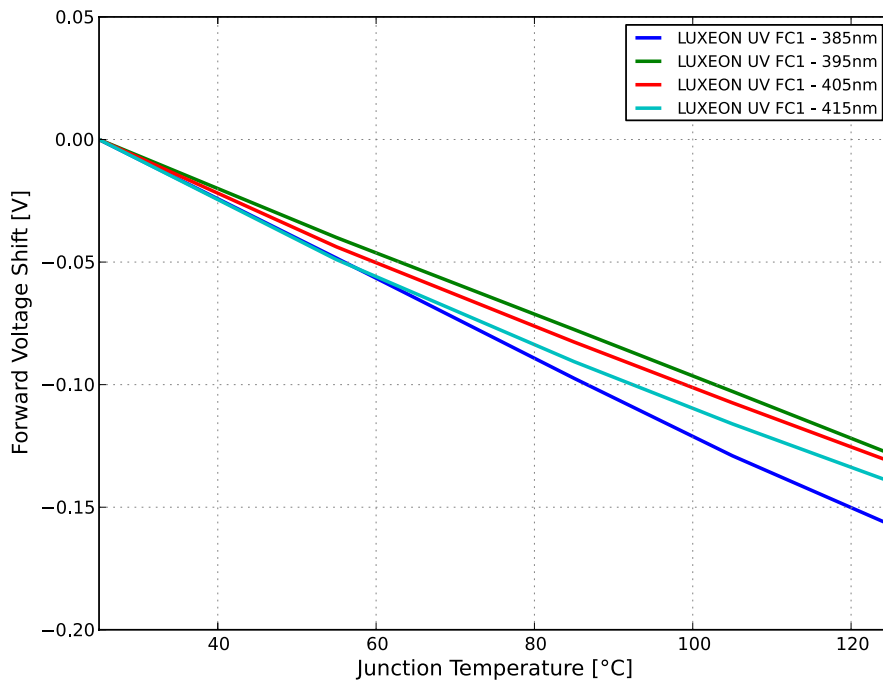

Figure 5. Typical forward voltage shift vs. junction temperature for LUXEON UV FC Line at  $T_j=25^\circ\text{C}$ .

# Wavelength Shift

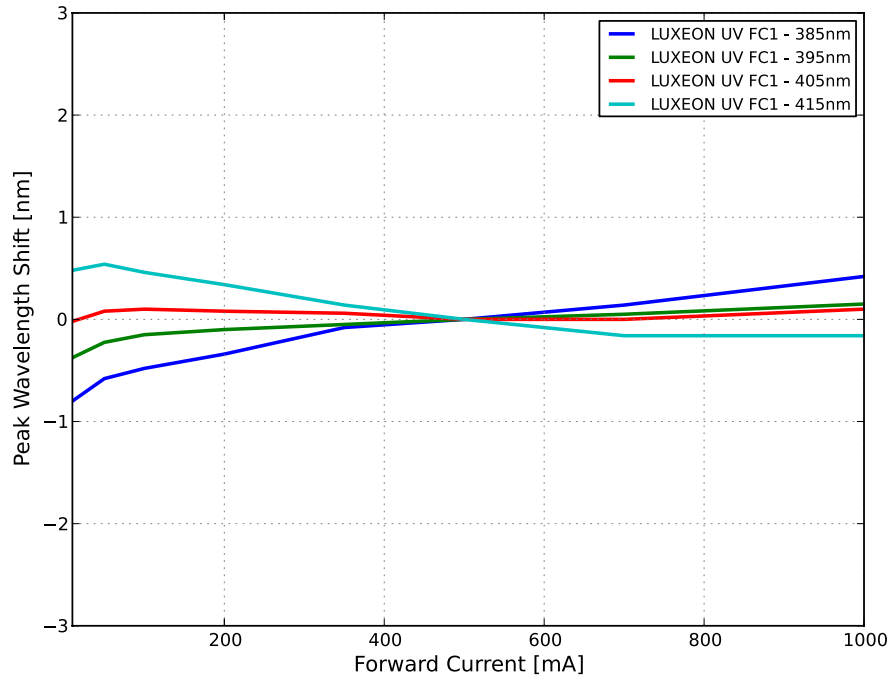

Figure 6. Typical peak wavelength shift vs. forward current for LUXEON UV FC Line at  $T_j=25^\circ\text{C}$ .

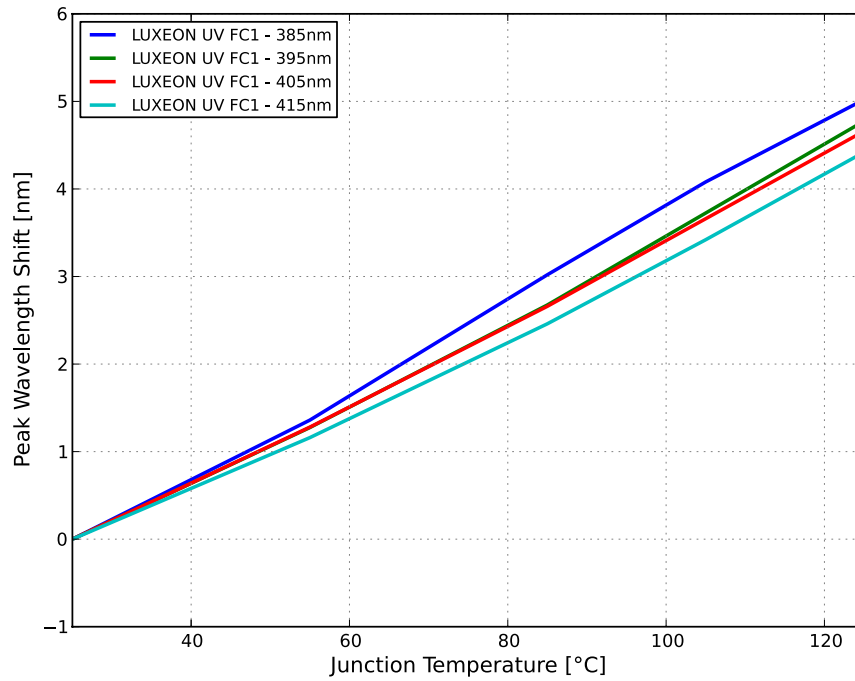

Figure 7. Typical peak wavelength vs. junction temperature for LUXEON UV FC Line at 500mA.



## Radiation Pattern Characteristics

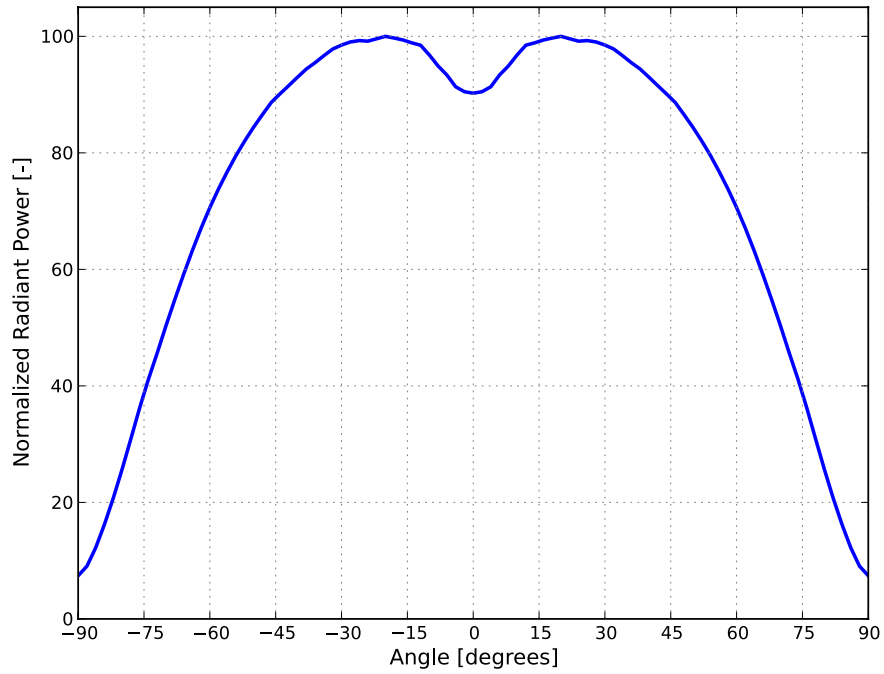

Figure 8. Typical radiation pattern for LUXEON UV FC Line at 500mA,  $T_j=25^{\circ}\text{C}$ .

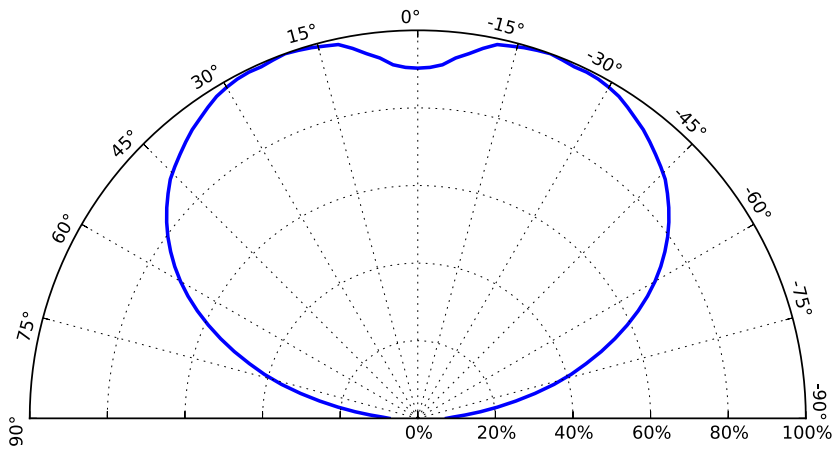

Figure 9. Typical polar radiation pattern for LUXEON UV FC Line at 500mA,  $T_j=25^{\circ}\text{C}$ .

# Product Bin and Labeling Definitions

## Decoding Product Bin Labeling

In the manufacturing of semiconductor products, there are variations in performance around the average values given in the technical datasheet. For this reason, Lumileds bins LED components for luminous flux or radiometric power, color point, peak or dominant wavelength and forward voltage.

LUXEON UV FC Line LEDs are labeled using a 4-digit alphanumeric CAT code following the format below:

### **A B c D**

- A** – designates radiometric power bin (example: B=300 to 350mW, D=400 to 450mW, F=500 to 550mW)
- B c** – designates peak wavelength bin (example: Ax=380 to 385nm, Cx=390 to 395nm, Ex=400 to 405nm)
- D** – designates forward voltage bin (example: 8=2.8 to 2.9V, 0=3.0 to 3.1V)

Therefore, a LUXEON UV FC LED with a radiometric power range of 400 to 450mW, peak wavelength range of 400 to 405nm and a forward voltage range of 3.0 to 3.1V has the following CAT code:

### **D E x 0**

## Radiometric Power Bins

Table 5 lists the standard radiometric power bins for LUXEON UV FC Line emitters. Although several bins are outlined, product availability in a particular bin varies by production run and by product performance. Not all bins are available in all CCTs.

**Table 5. Radiometric power bin definitions for LUXEON UV FC Line.**

BIN	RADIOMETRIC POWER <sup>(1)</sup> (mW)	
	MINIMUM	MAXIMUM
B	300	350
C	350	400
D	400	450
E	450	500
F	500	550
G	550	600
H	600	650
I	650	700
J	700	750
K	750	800
L	800	850
M	850	900
A1	400	600
B1	600	800
C1	800	1000
D1	1000	1200
E1	1200	1400
F1	1400	1600
G1	1600	1800

Notes for Table 5:

1. Lumileds maintains a tolerance of  $\pm 10\%$  on radiometric power measurements.

## Peak Wavelength Bins

**Table 6. Peak wavelength definitions for LUXEON UV FC Line.**

BIN	PEAK WAVELENGTH <sup>(1)</sup> (nm)	
	MINIMUM	MAXIMUM
Ax	380	385
Bx	385	390
Cx	390	395
Dx	395	400
Ex	400	405
Fx	405	410
Gx	410	415
Hx	415	420

Notes for Table 6:

1. Lumileds maintains a tolerance of  $\pm 2\text{nm}$  on peak wavelength measurements.

# Forward Voltage Bins

Table 7. Forward voltage bin definitions for LUXEON UV FC Line.

BIN	FORWARD VOLTAGE <sup>(1)</sup> (V)	
	MINIMUM	MAXIMUM
7	2.7	2.8
8	2.8	2.9
9	2.9	3.0
0	3.0	3.1
1	3.1	3.2
2	3.2	3.3
3	3.3	3.4
4	3.4	3.5
T	2.8	3.0
V	3.0	3.2
W	3.2	3.4
X	3.4	3.6

**Notes for Table 7:**

1. Lumileds maintains a tolerance of  $\pm 0.05V$  on forward voltage measurements.

## Mechanical Dimensions

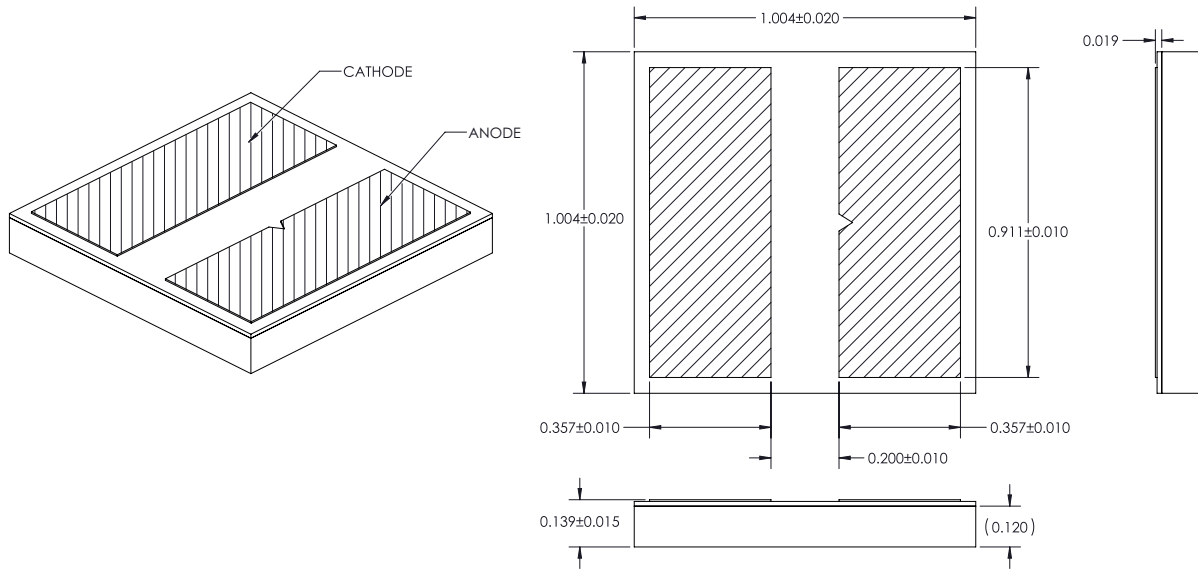

Figure 10. Mechanical dimensions for LUXEON UV FC Line.

**Notes for Figure 10:**

1. Drawings are not to scale.
2. All dimensions are in millimeters.

# Reflow Soldering Guidelines

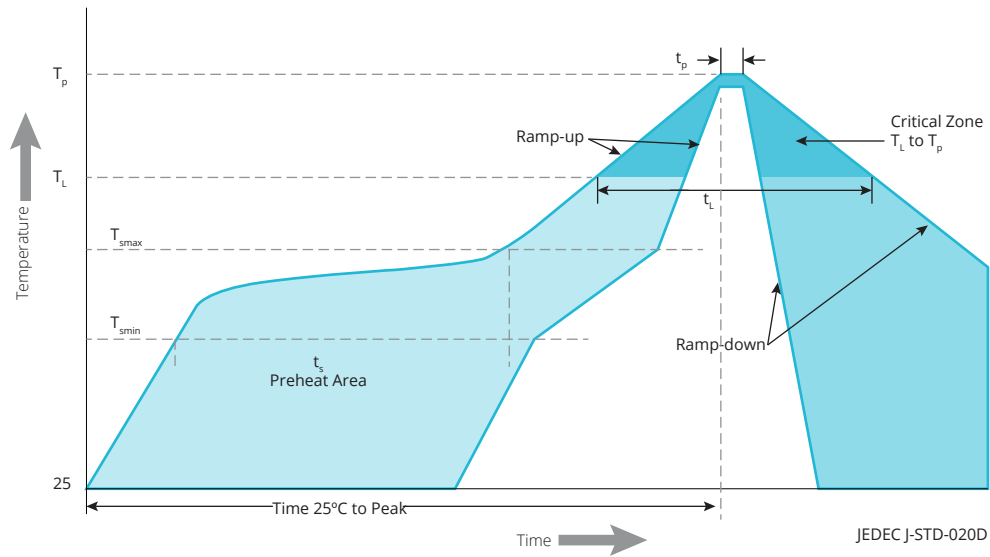

Figure 11. Visualization of the acceptable reflow temperature profile as specified in Table 8.

Table 8. Reflow profile characteristics for LUXEON UV FC Line (non-AuSn solder system)<sup>[1]</sup>.

PROFILE FEATURE	LEAD-FREE ASSEMBLY
Preheat Minimum Temperature ( $T_{smin}$ )	150°C
Preheat Maximum Temperature ( $T_{smax}$ )	200°C
Preheat Time ( $t_{smin}$ to $t_{smax}$ )	60 to 120 seconds
Ramp-Up Rate ( $T_L$ to $T_p$ )	3°C / second maximum
Liquidus Temperature ( $T_L$ )	217°C
Time Maintained Above Temperature $T_L$ ( $t_t$ )	60 to 150 seconds
Peak / Classification Temperature ( $T_p$ )	260°C
Time Within 5°C of Actual Temperature ( $t_p$ )	20 to 40 seconds
Ramp-Down Rate ( $T_p$ to $T_L$ )	6°C / second maximum
Time 25°C to Peak Temperature	8 minutes maximum

**Notes for Table 8:**

1. Characteristics are for non-AuSn lead-free solder system only (for AuSn (gold-tin) solder system, see [AB116](#) for more details).

## JEDEC Moisture Sensitivity

Table 9. Moisture sensitivity levels for LUXEON UV FC Line.

LEVEL	FLOOR LIFE		SOAK REQUIREMENTS STANDARD	
	TIME	CONDITIONS	TIME	CONDITIONS
1	Unlimited	≤30°C / 85% RH	168 Hours +5 / -0	85°C / 85% RH

# Solder Pad Design

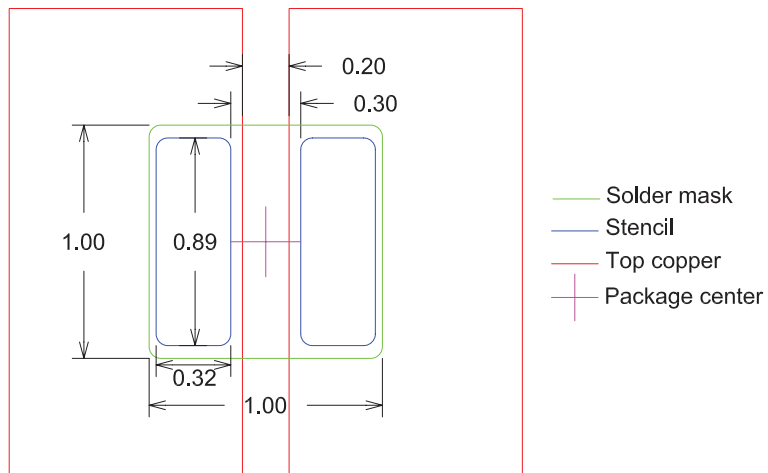

Figure 12. Recommended PCB solder pad layout for LUXEON UV FC Line.

**Notes for Figure 12:**

1. Drawings are not to scale.
2. All dimensions are in millimeters.

# Packaging Information

## Pocket Tape Dimensions

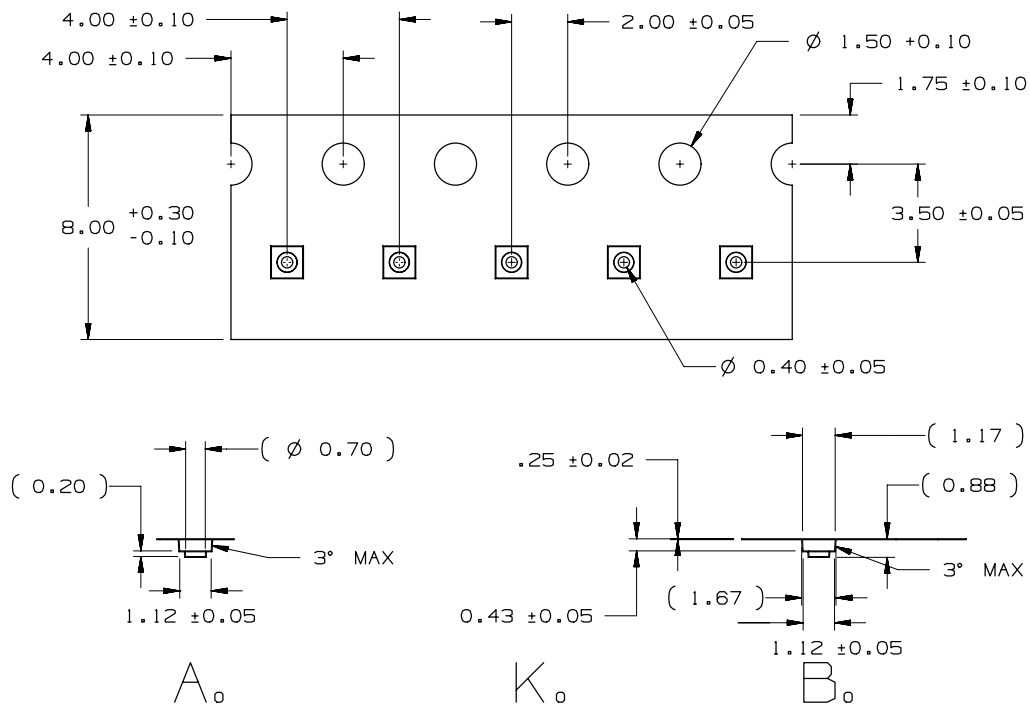

Figure 13. Pocket tape dimensions for LUXEON UV FC Line.

## Reel Dimensions

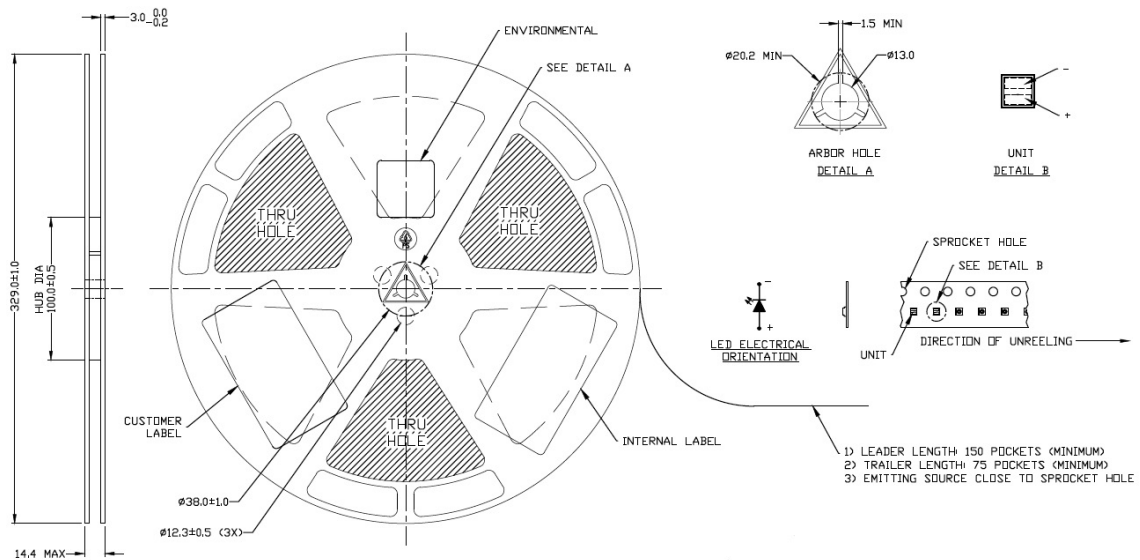

Figure 14. Reel dimensions for LUXEON UV FC Line.

Notes for Figures 13 and 14:  
 1. Drawings are not to scale.  
 2. All dimensions are in millimeters.

## About Lumileds

Companies developing automotive, mobile, IoT and illumination lighting applications need a partner who can collaborate with them to push the boundaries of light. With over 100 years of inventions and industry firsts, Lumileds is a global lighting solutions company that helps customers around the world deliver differentiated solutions to gain and maintain a competitive edge. As the inventor of Xenon technology, a pioneer in halogen lighting and the leader in high performance LEDs, Lumileds builds innovation, quality and reliability into its technology, products and every customer engagement. Together with its customers, Lumileds is making the world safer, better and more beautiful—with light.

To learn more about our lighting solutions, visit [lumileds.com](http://lumileds.com).



©2018 Lumileds Holding B.V. All rights reserved.  
LUXEON is a registered trademark of the Lumileds Holding B.V. in the United States and other countries.  
[lumileds.com](http://lumileds.com)

Neither Lumileds Holding B.V. nor its affiliates shall be liable for any kind of loss of data or any other damages, direct, indirect or consequential, resulting from the use of the provided information and data. Although Lumileds Holding B.V. and/or its affiliates have attempted to provide the most accurate information and data, the materials and services information and data are provided "as is," and neither Lumileds Holding B.V. nor its affiliates warrants or guarantees the contents and correctness of the provided information and data. Lumileds Holding B.V. and its affiliates reserve the right to make changes without notice. You as user agree to this disclaimer and user agreement with the download or use of the provided materials, information and data. A listing of Lumileds product/patent coverage may be accessed at [lumileds.com/patents](http://lumileds.com/patents).