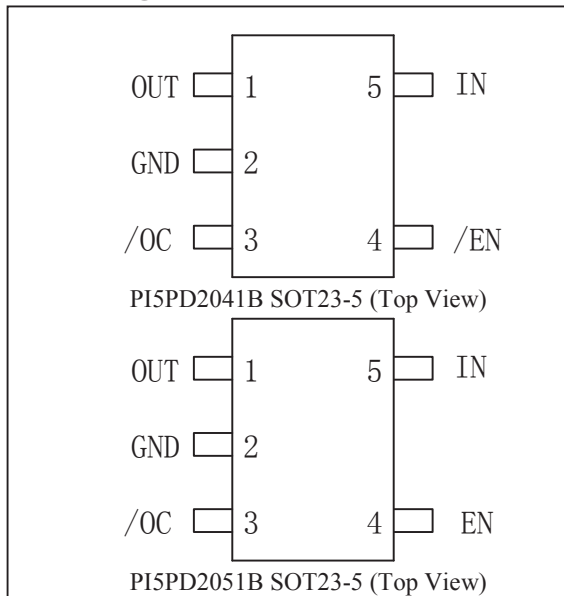

70mΩ Current-Limited, Power-Distribution Switches
Features

- 70mΩ High-Side MOSFET
- 0.5A Continuous Current
- Thermal and Short-Circuit Protection
- Accurate Current Limit (1.0A typ.)
- Operating Range: 2.7V to 5.5V
- 0.6ms Typical Rise Time
- Under-Voltage Lockout
- Deglitched Fault Report (/OC)
- 1μA Maximum Standby Supply Current
- Reverse Current Blocking
- Ambient Temperature Range: -40°C to 85°C
- UL Recognized, File Number E341484

Applications

- Laptop, Motherboard PC
- USB Bus/Self Powered Hubs
- TV and Set-top BOX Power switch
- USB Peripherals
- Battery-Powered Equipment
- Hot-Plug Power Supplies

Pin Configuration

Description

The PI5PD2041B/51B is an integrated 70mΩ N-channel MOSFET power switches for self-powered and bus-powered Universal Series Bus (USB) applications. The devices are equipped with charge pump circuitry to drive the internal MOSFET switch. The switch's low $R_{DS(on)}$, 70mΩ meets USB voltage drop requirements. This power-distribution switch is designed to set current limit at 1.0A typically.

When the output load exceeds the current-limit threshold or a short-circuit situation is present, the devices limit the output current by switching into a constant-current mode, pulling the over-current (/OC) logic output low. When continuous heavy overloads and short-circuits increase the power dissipation in the switch, causing the junction temperature to rise, a thermal protection circuit turns off the switch to prevent damage. Recovery from a thermal shutdown is automatic once the device has cooled sufficiently. Internal circuitry ensures that the switch remains off until valid input voltage is present.

Pin Description

Pin No.	Pin	Type	Description
2	GND	-	Ground.
5	IN	I	Power Input Voltage.
4	/EN (PI5PD2041B)	I	Chip Enable, logic low turns on power switch.
4	EN (PI5PD2051B)	I	Chip Enable, logic high turns on power switch.
3	/OC	O	Over current, open-drain output, active-low.
1	OUT	O	Power Output Voltage

Functional Block Diagram

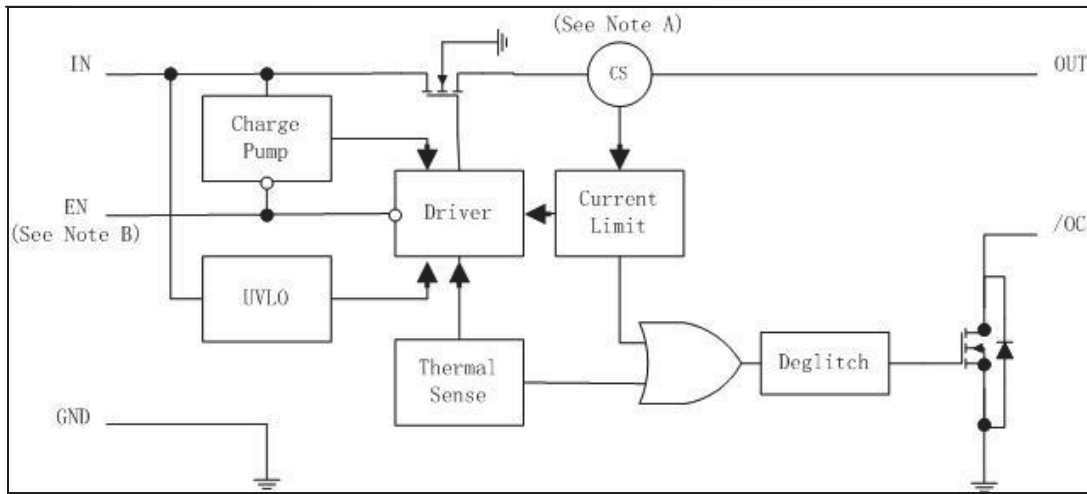

Note A: Current sense

Note B: Active low (/EN) for PI5PD2041B; Active high (EN) for PI5PD2051B

Maximum Ratings

Storage Temperature	-65°C to +150°C
Operating virtual junction temperature range, T_J	-40°C to +125°C
Input Voltage range ($V_{I(IN)}$) ⁽²⁾	-0.3V to +6V
Output Voltage range ($V_{O(OUT)}$) ⁽²⁾	-0.3V to +6V
Input Voltage range ($V_{I(EN)}$, $V_{I(EN)}$)	-0.3V to +6V
Voltage range ($V_{I(OC)}$, $V_{I(OC)}$)	-0.3V to +6V
Continuous output current ($I_{O(OUT)}$)	Internally limit
Power Dissipation	SOT23-5/400mW
Electrostatic discharge (ESD) protection	4kV/Human body MIL-STD-883C
Electrostatic discharge (ESD) protection	500V/Charge device model(CDM)

Note:

(1) Stresses greater than those listed under MAXIMUM RATINGS may cause permanent damage to the device. This is a stress rating only and functional operation of the device at these or any other conditions above those indicated in the operational sections of this specification is not implied. Exposure to absolute maximum rating conditions for extended periods may affect reliability.

(2) All voltages are with respect to GND.

Recommended Operating Conditions

Symbol	Description	Min	Type	Max	Unit
$V_{I(IN)}$	Input Voltage	2.7	-	5.5	V
$V_{I(EN)}$, $V_{I(EN)}$	Input Voltage	0	-	5.5	V
$I_{O(OUT)}$	Continuous Output Current	0	-	0.5	A
T_J	Operating Virtual Junction Temperature Range	-40	-	125	°C

Electrical Characteristics

Unless otherwise specified, $V_{I(IN)} = 5.5V$, $I_O = 0.5A$, $V_{I(EN)} = 0V$, $V_{I(EN)} = 5.5V$.

Sym	Description	Test Conditions ⁽¹⁾	Min	Typ	Max	Unit	
Power Switch							
$R_{DS(on)}$	Static drain-source on-state resistance, 5V operation and 3.3V operation	$V_{I(IN)} = 5V$ or $3.3V$, $I_O = 0.5A$, $-40^\circ C \leq T_J \leq 125^\circ C$	-	70	135	mΩ	
	Static drain-source on-state resistance, 2.7V operation ⁽²⁾	$V_{I(IN)} = 2.7V$, $I_O = 0.5A$, $-40^\circ C \leq T_J \leq 125^\circ C$	-	75	150	mΩ	
$t_r^{(2)}$	Rise time, output	$V_{I(IN)} = 5.5V$	$C_L = 1\mu F$, $R_L = 10\Omega$, $T_J = 25^\circ C$	-	0.6	1.5	ms
		$V_{I(IN)} = 2.7V$		-	0.4	1	
$t_f^{(2)}$	Fall time, output	$V_{I(IN)} = 5.5V$		0.05	-	0.5	
		$V_{I(IN)} = 2.7V$		0.05	-	0.5	
Enable Input /EN or EN							
V_{IH}	High-level input voltage	$2.7V \leq V_{I(IN)} \leq 5.5V$	2	-	-	V	
V_{IL}	Low-level input voltage	$2.7V \leq V_{I(IN)} \leq 5.5V$	-	-	0.8		
I_I	Input current	$V_{I(EN)} = 0V$ or $5.5V$	-0.5	-	0.5	μA	
$t_{on}^{(2)}$	Turn on time	$C_L = 100\mu F$, $R_L = 10\Omega$	-	-	3	ms	
$t_{off}^{(2)}$	Turn off time	$C_L = 100\mu F$, $R_L = 10\Omega$	-	-	10		
Current Limit							
I_{OS}	Short-circuit output current	$V_{I(IN)} = 5V$, OUT connected to GND, device enabled into short-circuit	$T_J = 25^\circ C$	0.75	1	1.25	A
			$-40^\circ C \leq T_J \leq 125^\circ C$	0.7	1	1.3	
$I_{OC-TRIP}$	Over-current trip threshold	$V_{I(IN)} = 5V$, current ramp (≤ 100 A/s) on OUT	1.1	1.5	2.5	A	
Supply Current							
I_{STB}	Input supply current at output disable	No load on OUT, $V_{I(EN)} = 5.5V$, or $V_{I(EN)} = 0V$	$T_J = 25^\circ C$	-	0.1	-	μA
			$-40^\circ C \leq T_J \leq 125^\circ C$	-	0.2	-	
I_{SS}	Input supply current at output enable	No load on OUT, $V_{I(EN)} = 0V$, or $V_{I(EN)} = 5.5V$	$T_A = 25^\circ C$	-	43	-	
			$-40^\circ C \leq T_J \leq 125^\circ C$	-	43	-	
	Leakage current	OUT connected to ground, $V_{I(EN)} = 5.5V$, or $V_{I(EN)} = 0V$	$-40^\circ C \leq T_J \leq 125^\circ C$	-	1	-	
	Reverse leakage current	$V_{I(OUT)} = 5.5V$, IN = ground ⁽²⁾	$T_J = 25^\circ C$	-	0.1	-	
Under-voltage Lockout							
	Low-level input voltage, IN	-	2	-	2.5	V	
	Hysteresis, IN	$T_J = 25^\circ C$	-	75	-	mV	
Over-current /OC							
	Output low voltage, $V_{OL(OC)}$	$I_{O(OC)} = 5mA$	-	-	0.4	V	
	Off-state current ⁽²⁾	$V_{O(OC)} = 5V$ or $3.3V$	-	-	1	μA	
	/OC deglitch ⁽²⁾	/OC assertion or de-assertion	4	12	15	ms	
Thermal Shutdown⁽³⁾							
	Thermal shutdown threshold ⁽²⁾	-	135	-	-	°C	
	Recovery from thermal shutdown ⁽²⁾	-	125	-	-	°C	
	Hysteresis ⁽²⁾	-	-	10	-	°C	

Note:

- (1) Pulse-testing techniques maintain junction temperature close to ambient temperature; thermal effects must be taken into account separately.
- (2) Not tested in production, specified by design.
- (3) The thermal shutdown only reacts under over current conditions.

Typical Performance and Characteristics

1. Turn On Delay and Rise Time

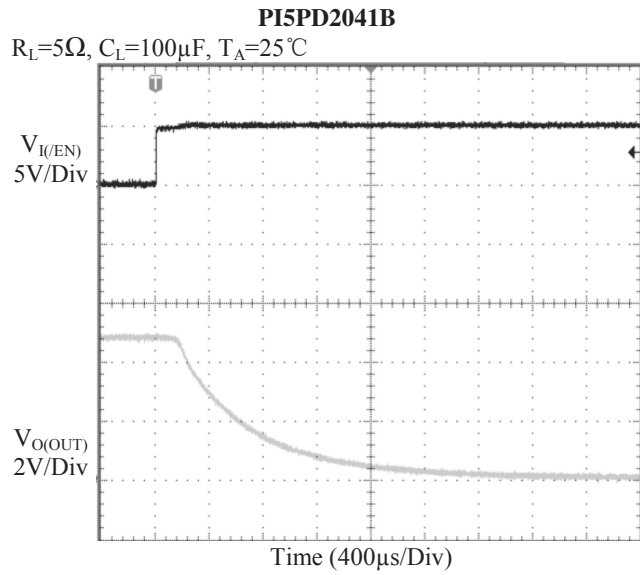
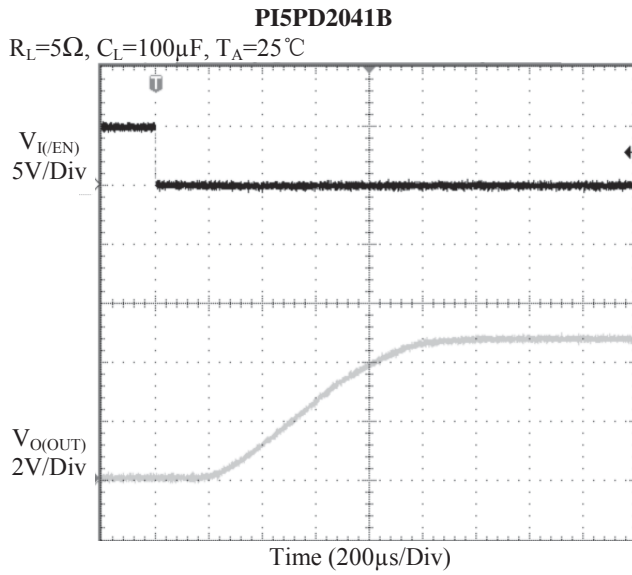
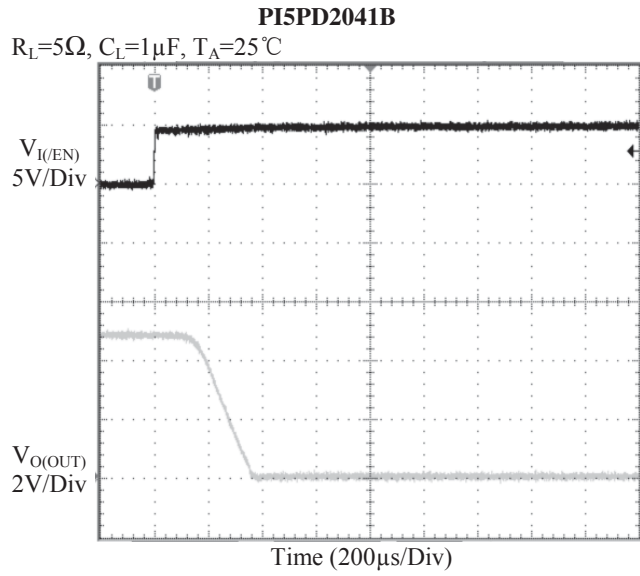
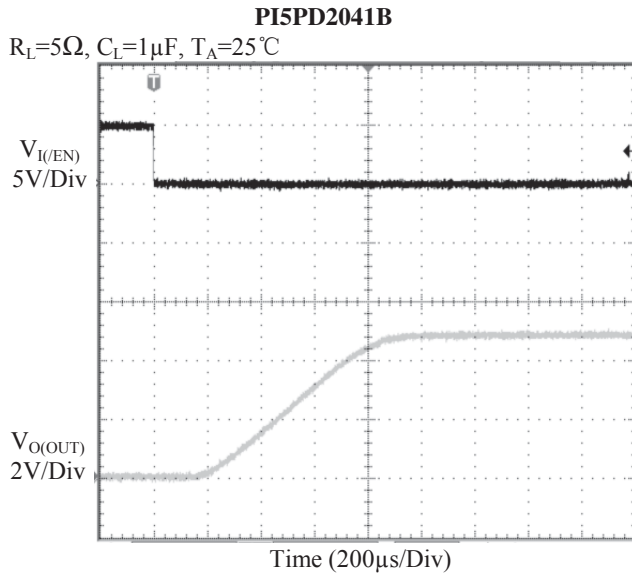

2. Over Current /OC Response
PI5PD2041B

$T_A=25^\circ\text{C}$, $R_L=2\Omega$, $C_L=0.1\mu\text{F}$

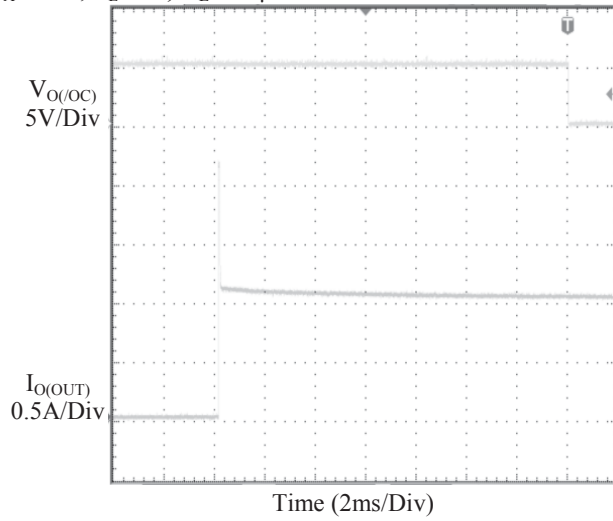

3. Output Short to Ground Then Enable
PI5PD2041B

$T_A=25^\circ\text{C}$

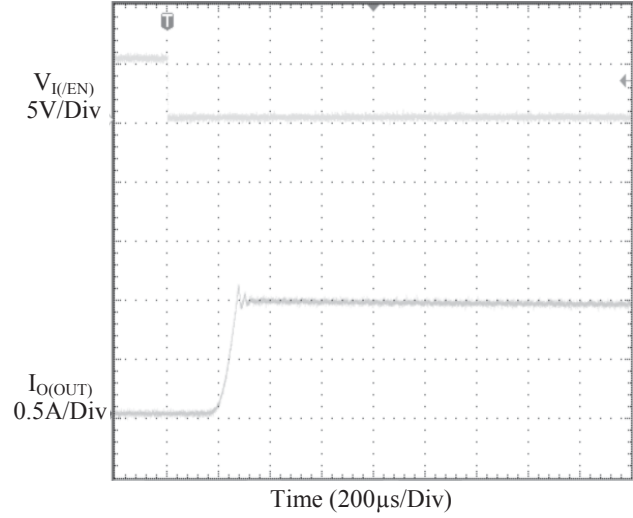

4. Inrush Current

PI5PD2041B

$T_A=25^\circ\text{C}$, $V_{I(IN)}=5\text{V}$, $R_L=10\Omega$

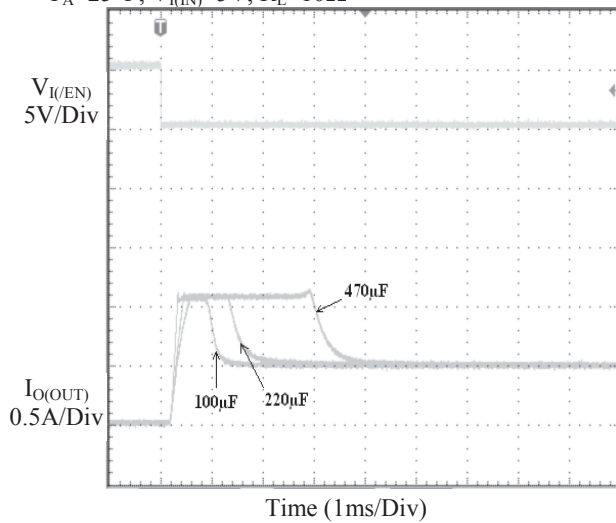

5. Turn On/Off Time vs. Input Voltage

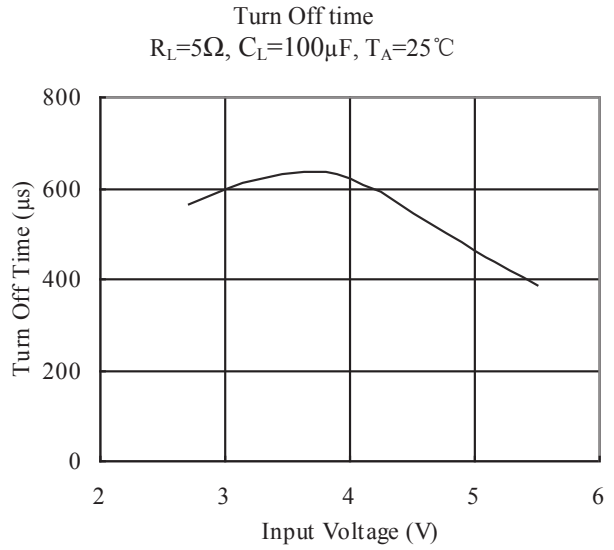
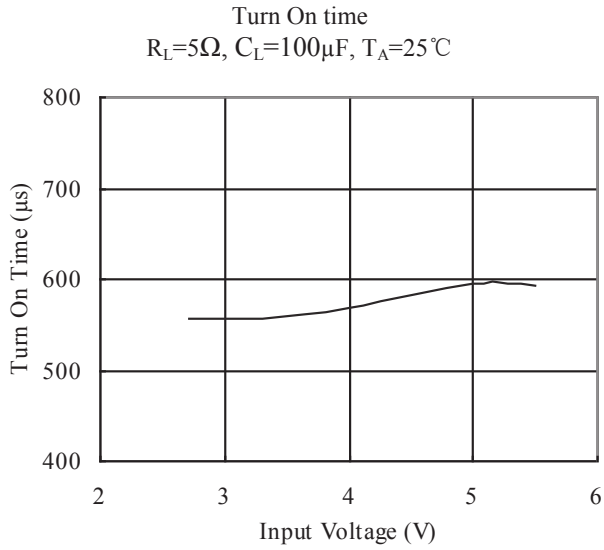

6. Rise and Fall Time vs. Input Voltage

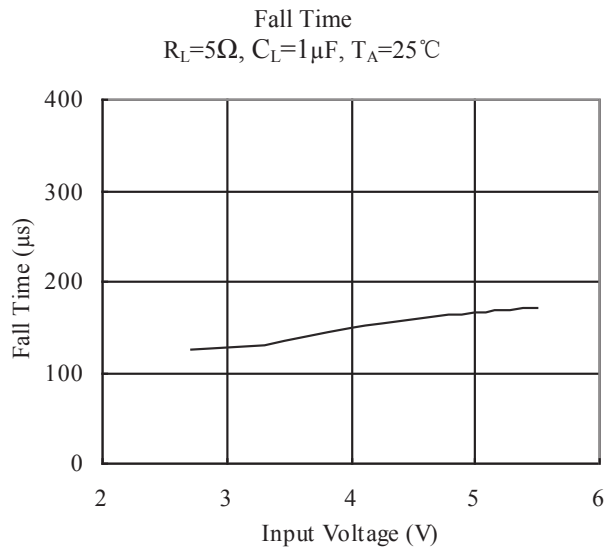
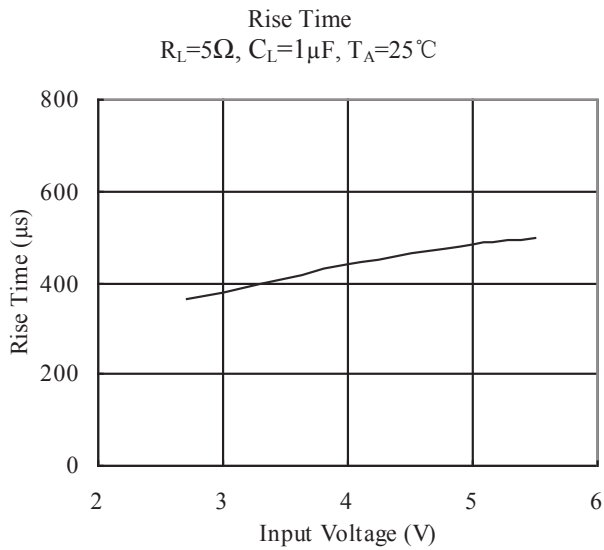

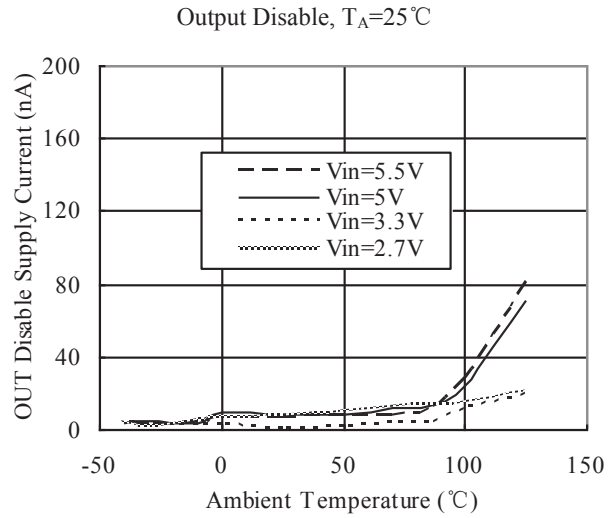
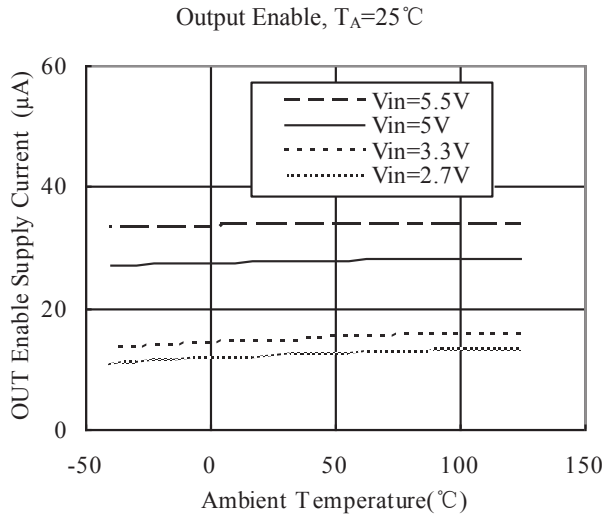
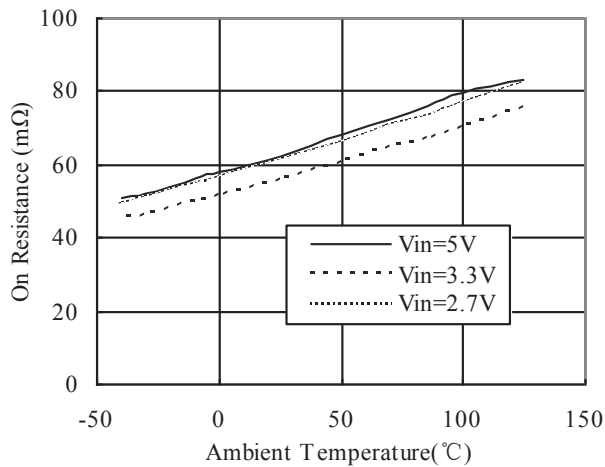
7. Input Supply Current vs. Ambient Temperature

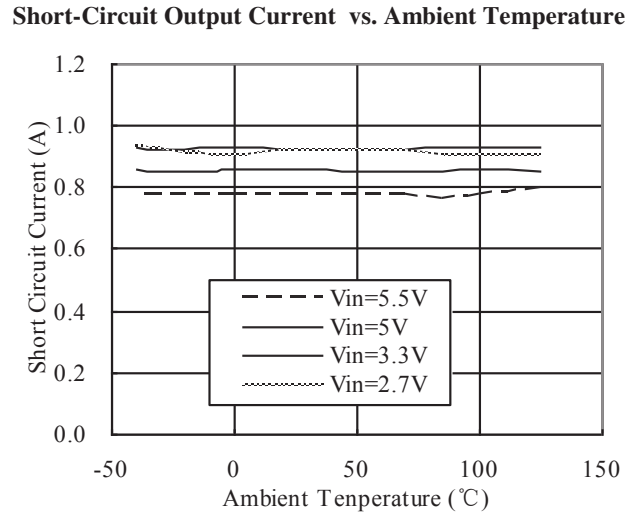
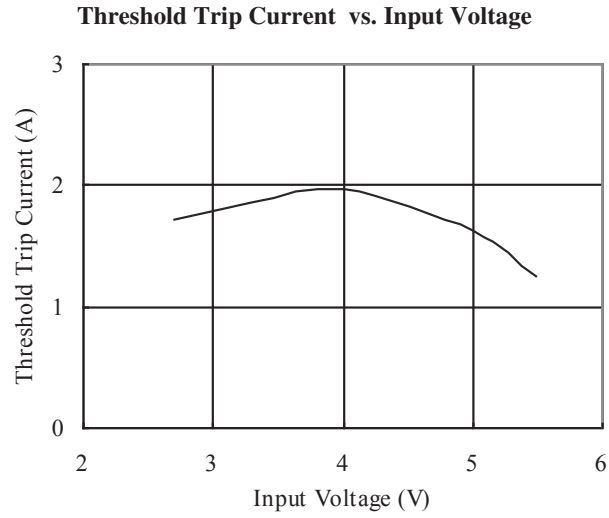
8. Static Drain-source On Resistance vs. Ambient Temperature

9. Current Limit vs. Ambient Temperature

Application Information

The power switch is an N-channel MOSFET with a low $R_{DS(on)}$ 70mΩ resistance. Configured as a high-side switch, the power switch prevents leakage current flow from output to input when chip disabled. The power switch supplies a maximum continuous current up to 0.5A.

Power-Supply Considerations

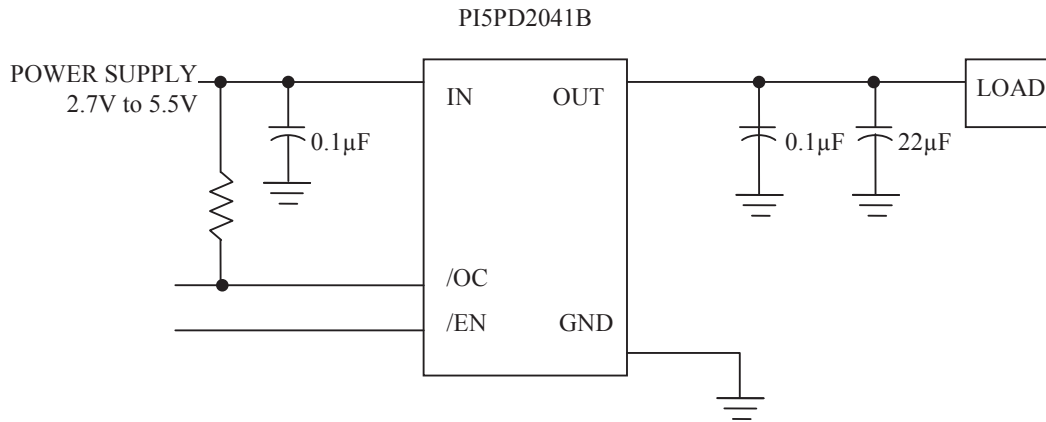

Figure 1 Typical Application Circuit

A 0.01µF to 1µF ceramic bypass capacitor between IN and GND, close to the device, is recommended. Placing a high-value electrolytic capacitor on the output pin(s) is recommended when the output load is heavy. This precaution reduces power-supply transients that may cause ringing on the input. Additionally, bypassing the output with a 0.01µF to 1µF ceramic capacitor improves the immunity of the device to short-circuit transients.

Enable (/EN or EN)

The enable pin is logic enable & disables the power switch, which is compatible with CMOS and TTL logic levels. The supply current is reduced to less than 1µA when a logic high is present on /EN, or when a logic low is present on EN. A logic zero input on /EN, or a logic high input on EN restores the bias to the driver and control circuits and turns the switch on

/OC Output

The /OC open-drain output is asserted (active low) when an over current or over temperature condition is asserted. The output remains asserted until the over current or over temperature condition is removed. The /OC pin requires a pull-up resistor, this resistor should be larger to reduce energy drain. A 100KΩ pull-up resistor works well for most applications. In the case of an over-current or short-circuit conditions, /OC will be asserted only after response delay time, T_d , 14ms have elapsed. If an over temperature shutdown occurs, the /OC is asserted instantaneously.

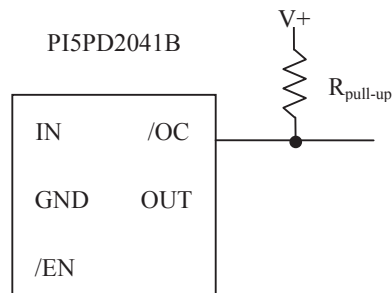

Figure 2 Typical Circuit for the /OC Pin

Under-Voltage Lockout (UVLO)

A voltage sense circuit monitors the input voltage, an under voltage lockout ensures that the power switch is in the off state at power up. When the input voltage is below approximately 2V, a control signal turns off the power switch.

Power Dissipation Calculation

The low $R_{DS(on)}$ resistance on the N-channel MOSFET allows the small surface-mount packages to pass large currents. The thermal resistances of these packages are high compared to those of power packages. Begin by determining the $R_{DS(on)}$ of the N-channel MOSFET relative to the input voltage and operating temperature. Using this value, the power dissipation per switch can be calculated by:

$$\bullet P_D = R_{DS(on)} \times I^2$$

Multiply this number by the number of switches being used. This step renders the total power dissipation from the N-channel MOSFET.

Finally, calculate the junction temperature:

$$\bullet T_J = P_D \times R_{\theta JA} + T_A$$

Where:

- T_A = Ambient temperature °C
- $R_{\theta JA}$ = Thermal resistance
- P_D = Total power dissipation based on number of switches being used.

Thermal Protection

Thermal protection prevents damage to the IC when heavy-overload or short-circuit faults are present for extended periods of time. The PI5PD2041B/51B implements a thermal protection circuitry to monitor the operating junction temperature of the power distribution switch. In an over current or short-circuit condition cause to the junction temperature rises, when the die temperature rises to approximately 135°C due to over current conditions, the internal thermal protection circuitry turns off the switch, thus preventing the device from damage. Hysteresis is built into the thermal protection circuitry, and after the device has cooled approximately 10 degrees, the switch turns back on. The switch continues to cycle off and on until the fault is removed. The open-drain false reporting output (/OC) is asserted (active low) when an over temperature shutdown or over current occurs.

Universal Serial Bus (USB) Application

The universal serial bus (USB) interface is a 480Mb/s or 12Mb/s, multiplexed serial bus designed for low-to-medium bandwidth PC peripherals (e.g., keyboards, printers, scanners, and mice). The four-wire USB interface is conceived for dynamic attach-detach (hot plug-unplug) of peripherals. Two lines are provided for differential data, and two lines are provided for 5V power distribution.

USB data is a 3.3V level signal, but power is distributed at 5V to allow for voltage drops in cases where power is distributed through more than one hub across long cables. Each function must provide its own regulated 3.3V from the 5V input or its own internal power supply.

The USB specification defines the following five classes of devices, each differentiated by power-consumption requirements:

- Hosts/self-powered hubs (SPH)
- Bus-powered hubs (BPH)
- Low-power, bus-powered functions
- High-power, bus-powered functions
- Self-powered functions

SPHs and BPHs distribute data and power to downstream functions. The PI5PD2041B/51B has higher current capability than required by one USB port; so, it can be used on the host side and supplies power to multiple downstream ports or functions.

Host/Self-Powered and Bus-Powered Hubs

Hosts and SPHs have a local power supply that powers the embedded functions and the downstream ports (see Figure 3). This power supply must provide from 5.25V to 4.75V to the board side of the downstream connection under full-load and no-load conditions. Hosts and SPHs are required to have current-limit protection and must report over current conditions to the USB controller. Typical SPHs are desktop PCs, monitors, printers, and stand-alone hubs.

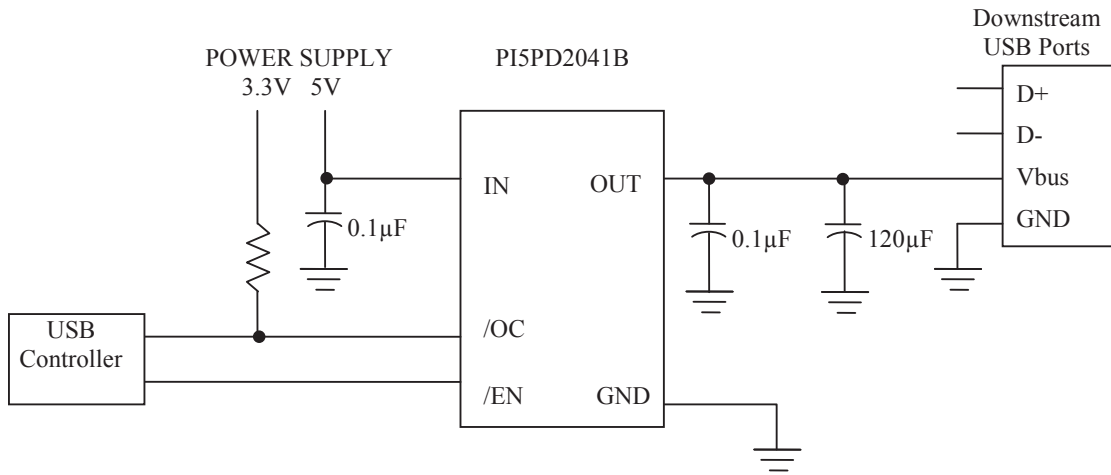
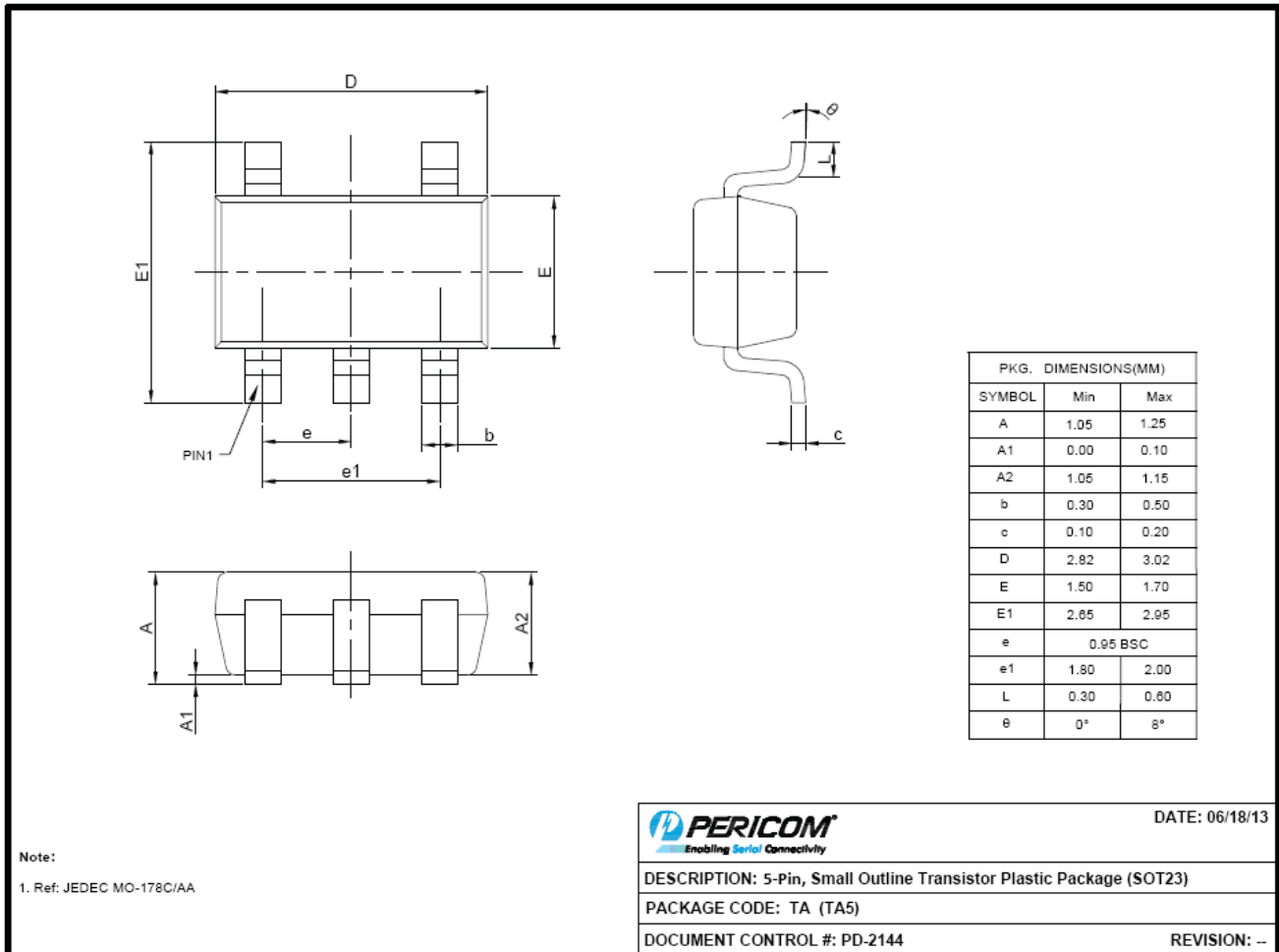

Figure 3 Typical One-Port USB Host/Self-Powered Hub

BPHs obtain all power from upstream ports and often contain an embedded function. The hubs are required to power up with less than one unit load. The BPH usually has one embedded function, and power is always available to the controller of the hub. If the embedded function and hub require more than 100mA on power up, the power to the embedded function may need to be kept off until enumeration is completed. This can be accomplished by removing power or by shutting off the clock to the embedded function. Power switching the embedded function is not necessary if the aggregate power draw for the function and controller is less than one unit load. The total current drawn by the bus-powered device is the sum of the current to the controller, the embedded function, and the downstream ports, and it is limited to 500mA from an upstream port.

Mechanical Information

TAE(Lead free and Green SOT23-5)



Ordering Information

Part Number	Package Code	Package
PI5PD2041BTAE	TA	Lead free and Green 5-Pin SOT23
PI5PD2051BTAE	TA	Lead free and Green 5-Pin SOT23

Notes:

- E = Pb-free and Green
- Adding X Suffix= Tape/Reel

Function comparison table

Part Number	Enable	Recommended maximum continuous load current	Typical short circuit current limit at 25°C	Number of switch
PI5PD2041B	Active Low	0.5A	1A	Single
PI5PD2051B	Active High			Single

Pericom Semiconductor Corporation • 1-800-435-2336 • www.pericom.com

Pericom reserves the right to make changes to its products or specifications at any time, without notice, in order to improve design or performance and to supply the best possible product. Pericom does not assume any responsibility for use of any circuitry described other than the circuitry embodied in Pericom product. The company makes no representations that circuitry described herein is free from patent infringement or other rights, of Pericom.