

●ストレートタイプ Vertical type

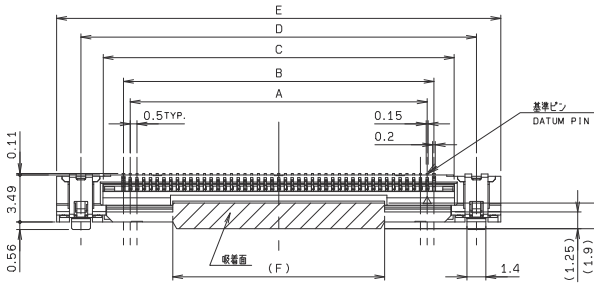

NO OF POS.	DIMENSION					
	A	B	C	D	E	F
10	4.5	5.5	8.58	11.8	15.4	3.2
20	9.5	10.5	13.58	16.8	20.4	3.2
30	14.5	15.5	18.58	21.8	25.4	8.2
35	17.0	18.0	21.08	24.3	27.9	10.7
40	19.5	20.5	23.58	26.8	30.4	13.2
45	22.0	23.0	26.08	29.3	32.9	15.7
50	24.5	25.5	28.58	31.8	35.4	18.2
60	29.5	30.5	33.58	36.8	40.4	23.2

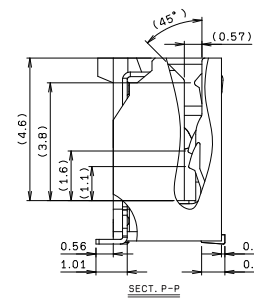
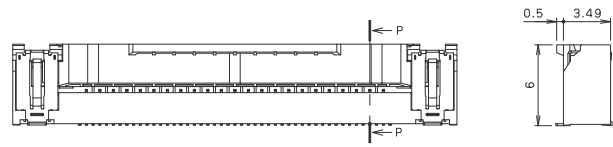

●基板取付寸法 Mounting Layout

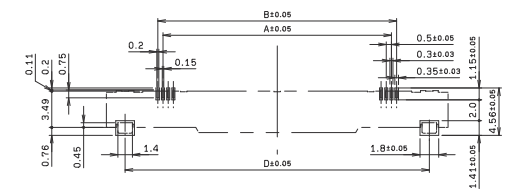

●適用FFC寸法 Applicable FFC

シールド有FFC
Shielded FFC

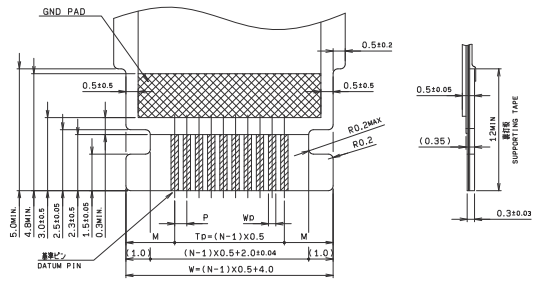

シールド無FFC
Un Shielded FFC

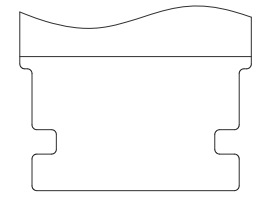
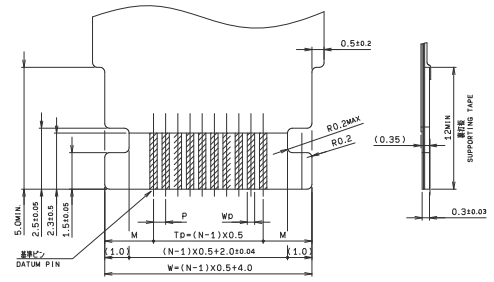

	1	2
M	2.0±0.1	2.0±0.08
P	0.5±0.03	0.5±0.05
TD	TD±0.03	TD±0.05
W	W±0.07	W±0.07
WD	0.3±0.05	0.3±0.05

※FPC寸法の詳細については、お問い合わせください。
Please feel free to contact about applicable fpc details.

●梱包形態 Packaging

10 pos.

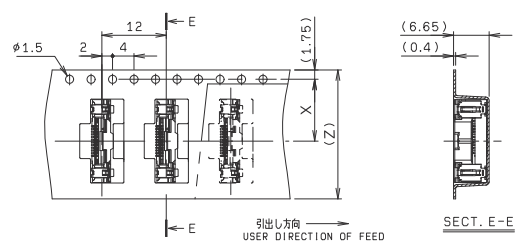

極数 NO. OF POS.	X	Y	Z
10	11.5	---	24.0
20	14.2	28.4	32.0
30	20.2	40.4	44.0
35	20.2	40.4	44.0
40	20.2	40.4	44.0
45	26.2	52.4	56.0
50	26.2	52.4	56.0
60	26.2	52.4	56.0

20 to 60 pos.

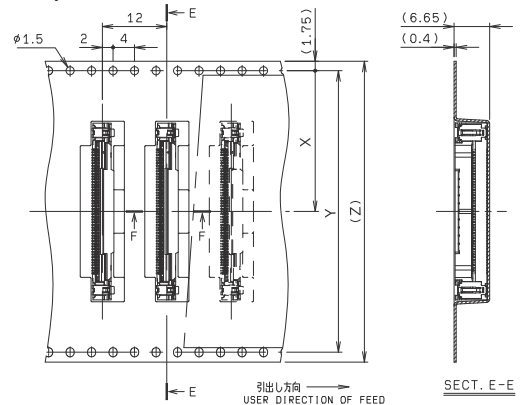

注文コード / Ordering Code

梱包数量 : 1,200 個/リール
PACKING QUANTITY: 1,200/Reel

●高耐熱タイプ

Part No. 04 6810 6XX 02X 846+T

極数 No. of Pos. 0 : グランドピン付き With Ground contact
2 : グランドピンなし Without Ground contact

●通常タイプ

Part No. 04 6810 6XX 00X 846+

極数 No. of Pos. 0 : グランドピン付き With Ground contact
2 : グランドピンなし Without Ground contact

RoHS 対応品
RoHS Compliant Product



●このカタログの記載内容については予告なく変更することがありますので、ご了承ください。
Specification of the catalogue might be changed without notice.
●御使用の際は、納入仕様書を確認の上、正しくお使いください。
Please verify our drawing and specification with your design.

●ライトアングルタイプ Right-angle type

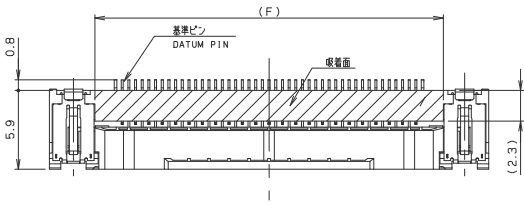

NO OF POS.	DIMENSION					
	A	B	C	D	E	F
10	15.4	8.58	4.5	5.5	11.8	8.6
20	20.4	13.58	9.5	10.5	16.8	13.6
30	25.4	18.58	14.5	15.5	21.8	18.6
35	27.9	21.08	17.0	18.0	24.3	21.1
40	30.4	23.58	19.5	20.5	26.8	23.6
45	32.9	26.08	22.0	23.0	29.3	26.1
50	35.4	28.58	24.5	25.5	31.8	28.6
60	40.4	33.58	29.5	30.5	36.8	33.6

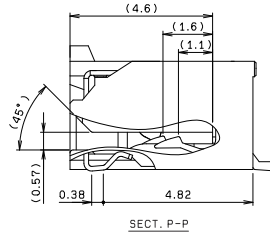
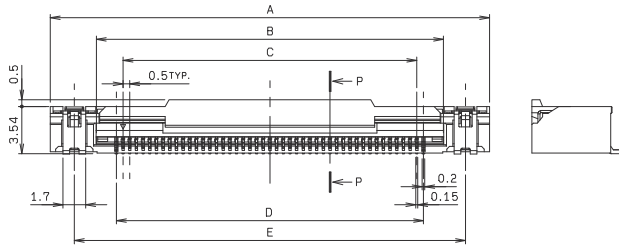

●基板取付寸法 Mounting Layout

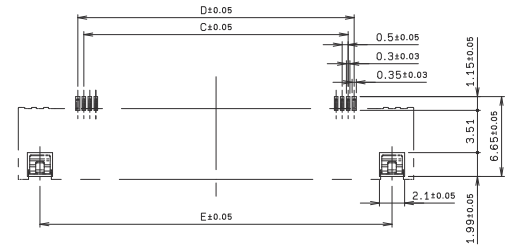

●適用FFC寸法 Applicable FFC

シールド有FFC
Shielded FFC

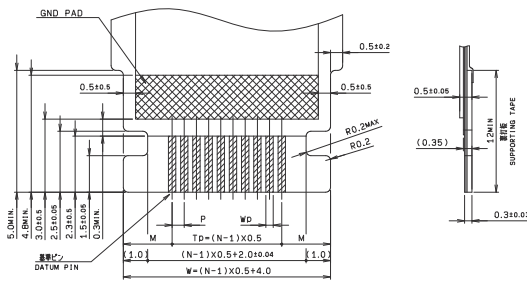

シールド無FFC
Un Shielded FFC

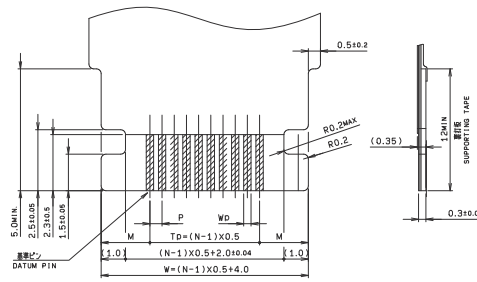

※FPC寸法の詳細については、お問い合わせください。
Please feel free to contact about applicable fpc details.

	1	2
M	2.0±0.1	2.0±0.08
P	0.5±0.03	0.5±0.05
Tp	Tp±0.03	Tp±0.05
W	W±0.07	W±0.07
WD	0.3 ^{+0.05} _{-0.02}	0.3 ^{+0.05} _{-0.02}

●梱包形態 Packaging

10 pos.

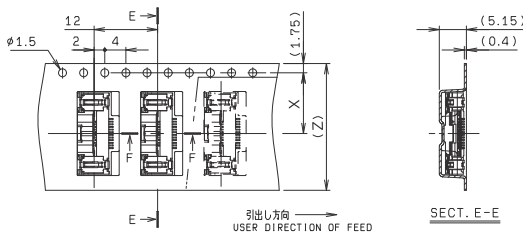

極数 NO. OF POS.	X	Y	Z
10	11.5	---	24.0
20	14.2	28.4	32.0
30	20.2	40.4	44.0
35	20.2	40.4	44.0
40	20.2	40.4	44.0
45	26.2	52.4	56.0
50	26.2	52.4	56.0
60	26.2	52.4	56.0

20 to 60 pos.

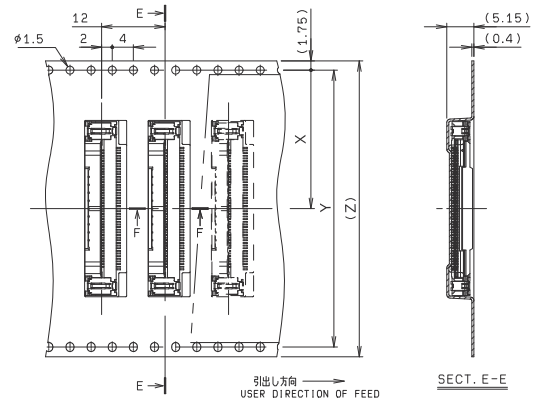

注文コード / Ordering Code

梱包数量: 1,500 個/リール
PACKING QUANTITY: 1,500/Reel

●高耐熱タイプ

Part No. 04 6810 6XX 02X 846+T

極数 No. of Pos. 1: グランドピン付き With Ground contact
3: グランドピンなし Without Ground contact

●通常タイプ

Part No. 04 6810 6XX 00X 846+

極数 No. of Pos. 1: グランドピン付き With Ground contact
3: グランドピンなし Without Ground contact

RoHS 対応品
RoHS Compliant Product



●このカタログの記載内容については予告なく変更することがありますので、ご了承ください。
Specification of the catalogue might be changed without notice.
●御使用の際は、納入仕様書を確認の上、正しくお使いください。
Please verify our drawing and specification with your design.