

Power-Distribution Switch With Adjustable Current-Limit EVM

This user's guide describes the TPS255xDBVEVM-271 and TPS255xDRVEVM-271 evaluation modules (EVM). This guide contains the EVM schematic, bill of materials, assembly drawing, and top and bottom board layouts.

Contents

1	Introduction	2
	1.1 Related Documentation from Texas Instruments	2
2	Electrical Specifications	2
	2.1 Electrostatic Discharge	2
3	Schematic and Bill of Materials	2
	3.1 EVM Options	2
	3.2 Schematic	3
	3.3 Bill of Materials	3
4	EVM Setup	3
	4.1 Recommended Test Equipment	3
	4.2 Measuring the Short-Circuit Output Current-Limit	4
	4.3 Adjusting the Short-Circuit Output Current-Limit	5
5	Board Layout	6

List of Figures

1	EVM Schematic	3
2	EVM Setup For Measuring Current-Limit	4
3	TPS2551DRVEVM-271 Short-Circuit Output Current and $\overline{\text{FAULT}}$ Status With J2 Shorting Jumper Present. ...	4
4	TPS2551DRVEVM-271 Short-Circuit Output Current and $\overline{\text{FAULT}}$ Status With J2 Shorting Jumper Absent.	5
5	EVM Top Assembly	6
6	EVM Top-Side Layout	6
7	EVM Bottom-Side Layout	7
8	EVM Bottom Assembly	7

List of Tables

1	EVM Electrical Specifications	2
2	EVM Options	2
3	EVM Bill of Materials	3

1 Introduction

The TPS255xDBVEVM-271 and TPS255xDRVEVM-271 are evaluation modules (EVM) for Texas Instruments' family of power-distribution switches with adjustable current-limit. These EVMs operate over a 2.5-V to 6.5-V range. An onboard jumper sets the output current-limit to either 0.5 A or 1 A. Test points provide convenient access to all critical node voltages.

The silkscreen outline on the PCB top-side encloses components found in a typical USB application.

The PCB top-side accepts a power-distribution switch in a SOT23-6 package; the PCB bottom side accepts a power-distribution switch in the smaller SON package with a thermal pad. These switches have an enable input, an overcurrent status output, and overtemperature shutdown.

1.1 Related Documentation from Texas Instruments

TPS2550, TPS2551 data sheet ([SLVS736](#))

2 Electrical Specifications

The EVM meets the electrical specifications in [Table 1](#) over the recommended operating junction-temperature range of $-40^{\circ}\text{C} \leq T_j \leq 105^{\circ}\text{C}$ for the DRV (SON) package and $-40^{\circ}\text{C} \leq T_j \leq 125^{\circ}\text{C}$ for the DBV (SOT23-6) package.

Table 1. EVM Electrical Specifications

Parameter	Condition	Min	Typ	Max	Unit
Input voltage, V_{in}	J1	2.5	–	6.5	Volt
Short-Circuit Output Current-Limit, ILIMIT	J2 shorting-jumper is absent, J3 is short circuited, TPS255x is enabled	0.60	0.65	0.72	Ampere
	J2 shorting-jumper is present, J3 is short circuited, TPS255x is enabled	1.20	1.28	1.38	

2.1 Electrostatic Discharge

The EVM has been tested to IEC 61000-4-2. The level used was 8-kV contact discharge and 15-kV air discharge. Surges were applied to the EVM input and output. No damage to the TPS255x was observed.

3 Schematic and Bill of Materials

3.1 EVM Options

Table 2. EVM Options

EVM	Device	Device Package	Enable
TPS2550DBVEVM-271	TPS2550DBV	SOT23-6	Active Low
TPS2551DBVEVM-271	TPS2551DBV	SOT23-6	Active High
TPS2550DRVEVM-271	TPS2550DRV	SON	Active Low
TPS2551DRVEVM-271	TPS2551DRV	SON	Active High

3.2 Schematic

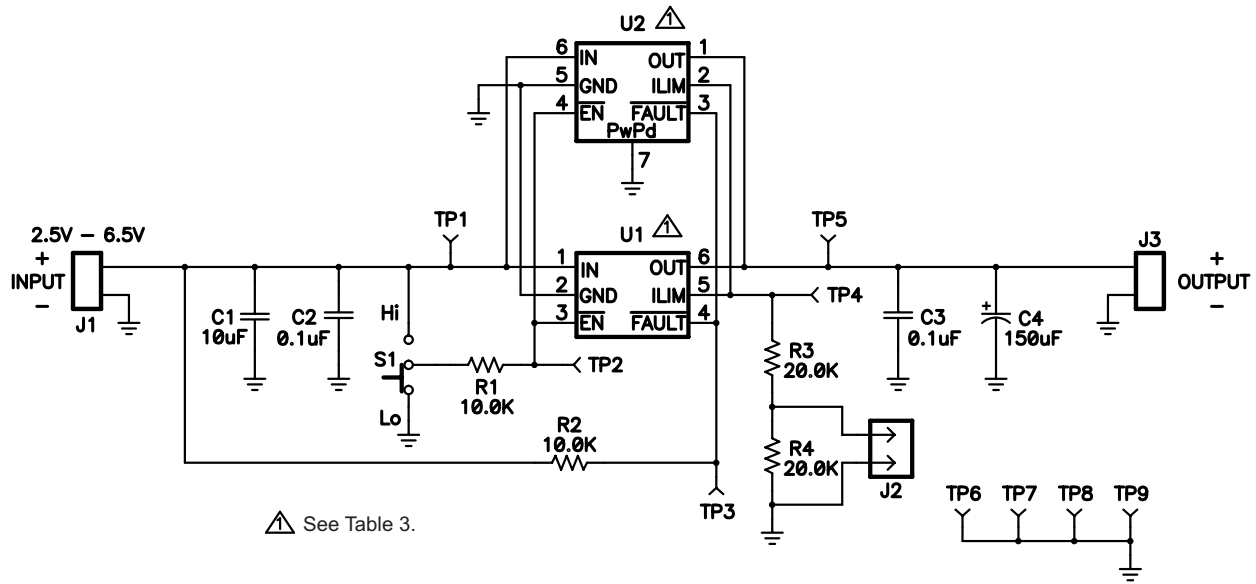

Figure 1. EVM Schematic

3.3 Bill of Materials

Table 3. EVM Bill of Materials

QTY				RefDes	Value	Description	Size	Part Number	MFR
-001	-002	-003	-004						
1	1	1	1	C1	10µF	Capacitor, Ceramic, 10-µF, X7R, 10V, 10%	1206	STD	STD
2	2	2	2	C2, C3	0.1µF	Capacitor, Ceramic, 16V, X7R, 10%	0805	STD	STD
1	1	1	1	C4	150µF	Capacitor, Tantalum, 150µF, 10V, 100mΩ, 10%	7343 (D)	B45197A2157K409	Kemet
1	0	0	0	U1	TPS2550DBV	IC, Power-Distribution Switch, Current-Limited	SOT-23-6	TPS2550DBV	TI
0	1	0	0	U1	TPS2551DBV	IC, Power-Distribution Switch, Current-Limited	SOT-23-6	TPS2551DBV	TI
0	0	1	0	U2	TPS2550DRV	IC, Power-Distribution Switch, Current-Limited	SON	TPS2550DRV	TI
0	0	0	1	U2	TPS2551DRV	IC, Power-Distribution Switch, Current-Limited	SON	TPS2551DRV	TI
1	1	1	1	--	HPA271	PCB, 2.25 In × 2.225 In × 0.062 In		HPA271	Any
2	2	2	2	R1, R2	10.0K	Resistor, Chip, 1/10W, 1%	0805	CRCW0805-1002F	Vishay
2	2	2	2	R3, R4	20.0K	Resistor, Chip, 1/10W, 1%	0805	CRCW0805-2002-F	Vishay

4 EVM Setup

4.1 Recommended Test Equipment

The following test equipment is recommended:

- Two-channel storage oscilloscope
- Current probe
- Voltage probe
- An adjustable power supply with a 2.5-V to 6.5-V output and a 5-A output current-limit
- Volt-ohm meter

- A passive or active load capable of handling 3 A.

4.2 Measuring the Short-Circuit Output Current-Limit

The user should read the TPS2550/1 data sheet before using the EVM.

Figure 2 shows the EVM test setup for measuring current-limit. Switch S1 enables the power-distribution switch into a short circuit for this measurement. Figure 3 shows the current waveform for the TPS2551DRVEVM-271 with a shorting jumper populating header J2; Figure 4 shows the current waveform with header J2 unpopulated.

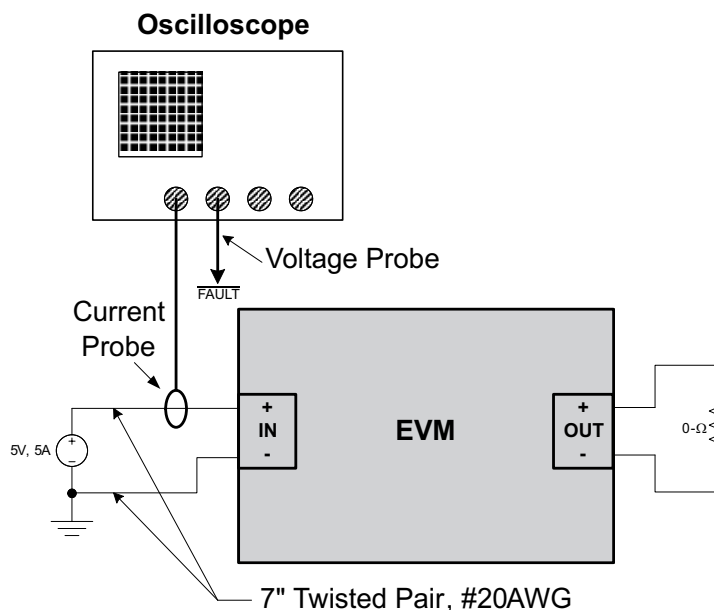

Figure 2. EVM Setup For Measuring Current-Limit

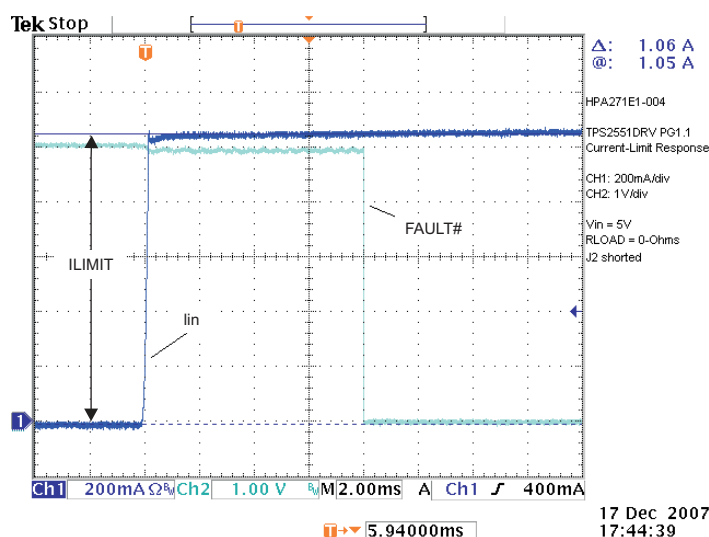

Figure 3. TPS2551DRVEVM-271 Short-Circuit Output Current and FAULT Status With J2 Shorting Jumper Present.

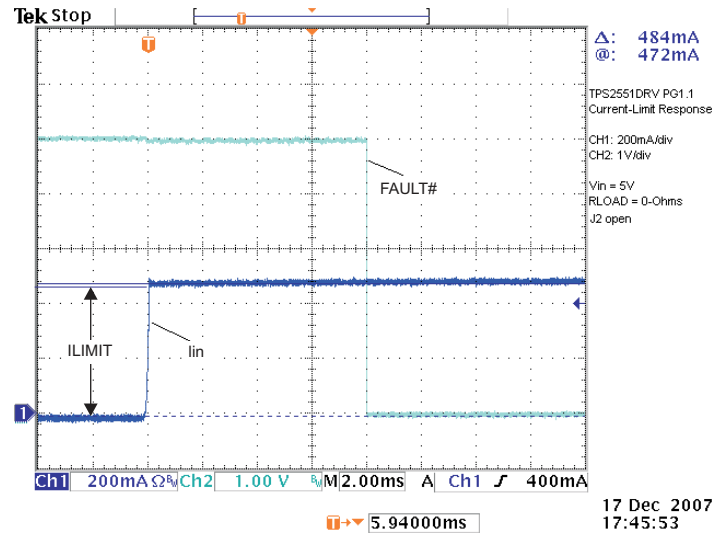

Figure 4. TPS2551DRVEVM-271 Short-Circuit Output Current and FAULT Status With J2 Shorting Jumper Absent.

4.3 Adjusting the Short-Circuit Output Current-Limit

The EVM provides two current-limit settings. If a different setting is required, then populate header J2 with a shorting jumper and modify resistor R3 according to Equation 1:

$$R3 = \left(\frac{28700}{ILIMIT} \right)^{1.114} \tag{1}$$

Where: $15\text{ k}\Omega \leq R3 \leq 80.6\text{ k}\Omega$.

The current-limit programming resistance, R3, is expressed in $\text{k}\Omega$ and the *typical* current-limit, ILIMIT, is expressed in mA. See the TPS2550/1 data sheet for the worst-case current-limit variation.

5 Board Layout

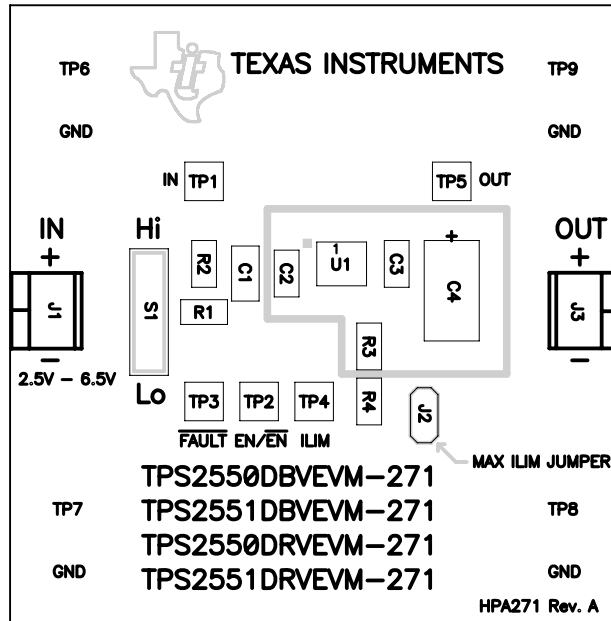

Figure 5. EVM Top Assembly

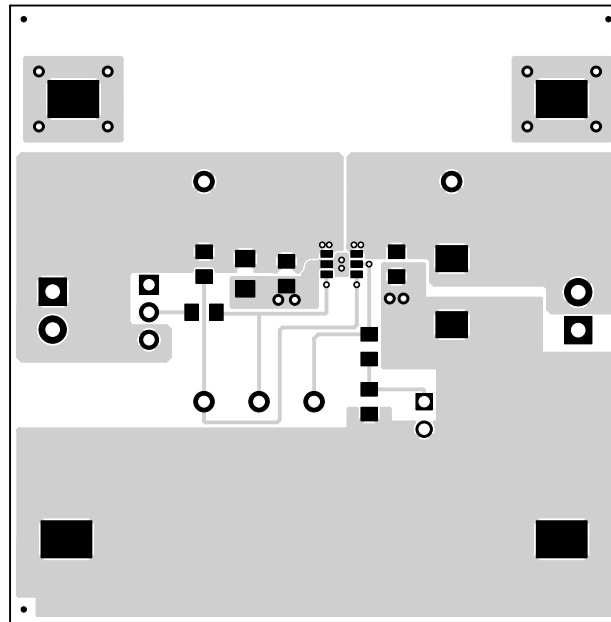

Figure 6. EVM Top-Side Layout

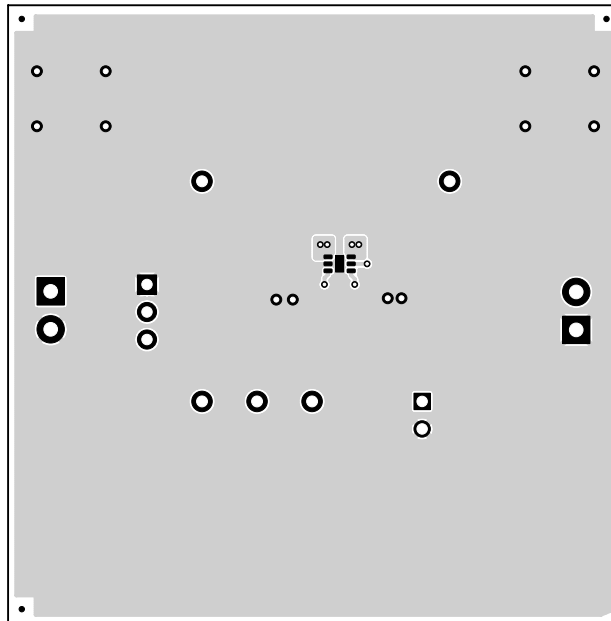

Figure 7. EVM Bottom-Side Layout

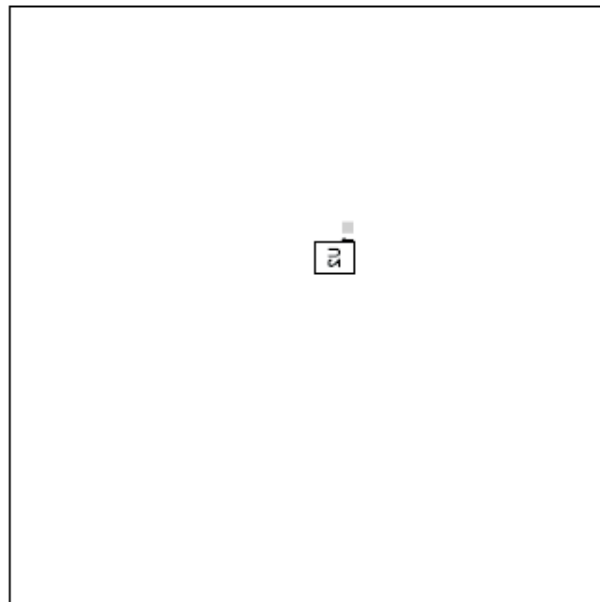

Figure 8. EVM Bottom Assembly

EVALUATION BOARD/KIT IMPORTANT NOTICE

Texas Instruments (TI) provides the enclosed product(s) under the following conditions:

This evaluation board/kit is intended for use for **ENGINEERING DEVELOPMENT, DEMONSTRATION, OR EVALUATION PURPOSES ONLY** and is not considered by TI to be a finished end-product fit for general consumer use. Persons handling the product(s) must have electronics training and observe good engineering practice standards. As such, the goods being provided are not intended to be complete in terms of required design-, marketing-, and/or manufacturing-related protective considerations, including product safety and environmental measures typically found in end products that incorporate such semiconductor components or circuit boards. This evaluation board/kit does not fall within the scope of the European Union directives regarding electromagnetic compatibility, restricted substances (RoHS), recycling (WEEE), FCC, CE or UL, and therefore may not meet the technical requirements of these directives or other related directives.

Should this evaluation board/kit not meet the specifications indicated in the User's Guide, the board/kit may be returned within 30 days from the date of delivery for a full refund. **THE FOREGOING WARRANTY IS THE EXCLUSIVE WARRANTY MADE BY SELLER TO BUYER AND IS IN LIEU OF ALL OTHER WARRANTIES, EXPRESSED, IMPLIED, OR STATUTORY, INCLUDING ANY WARRANTY OF MERCHANTABILITY OR FITNESS FOR ANY PARTICULAR PURPOSE.**

The user assumes all responsibility and liability for proper and safe handling of the goods. Further, the user indemnifies TI from all claims arising from the handling or use of the goods. Due to the open construction of the product, it is the user's responsibility to take any and all appropriate precautions with regard to electrostatic discharge.

EXCEPT TO THE EXTENT OF THE INDEMNITY SET FORTH ABOVE, NEITHER PARTY SHALL BE LIABLE TO THE OTHER FOR ANY INDIRECT, SPECIAL, INCIDENTAL, OR CONSEQUENTIAL DAMAGES.

TI currently deals with a variety of customers for products, and therefore our arrangement with the user **is not exclusive.**

TI assumes **no liability for applications assistance, customer product design, software performance, or infringement of patents or services described herein.**

Please read the User's Guide and, specifically, the Warnings and Restrictions notice in the User's Guide prior to handling the product. This notice contains important safety information about temperatures and voltages. For additional information on TI's environmental and/or safety programs, please contact the TI application engineer or visit www.ti.com/esh.

No license is granted under any patent right or other intellectual property right of TI covering or relating to any machine, process, or combination in which such TI products or services might be or are used.

FCC Warning

This evaluation board/kit is intended for use for **ENGINEERING DEVELOPMENT, DEMONSTRATION, OR EVALUATION PURPOSES ONLY** and is not considered by TI to be a finished end-product fit for general consumer use. It generates, uses, and can radiate radio frequency energy and has not been tested for compliance with the limits of computing devices pursuant to part 15 of FCC rules, which are designed to provide reasonable protection against radio frequency interference. Operation of this equipment in other environments may cause interference with radio communications, in which case the user at his own expense will be required to take whatever measures may be required to correct this interference.

EVM WARNINGS AND RESTRICTIONS

It is important to operate this EVM within the input voltage range of 2.5 V to 6.5 V and the output voltage range of 2.5 V to 6.5 V.

Exceeding the specified input range may cause unexpected operation and/or irreversible damage to the EVM. If there are questions concerning the input range, please contact a TI field representative prior to connecting the input power.

Applying loads outside of the specified output range may result in unintended operation and/or possible permanent damage to the EVM. Please consult the EVM User's Guide prior to connecting any load to the EVM output. If there is uncertainty as to the load specification, please contact a TI field representative.

During normal operation, some circuit components may have case temperatures greater than 85°C. The EVM is designed to operate properly with certain components above 85°C as long as the input and output ranges are maintained. These components include but are not limited to linear regulators, switching transistors, pass transistors, and current sense resistors. These types of devices can be identified using the EVM schematic located in the EVM User's Guide. When placing measurement probes near these devices during operation, please be aware that these devices may be very warm to the touch.

Mailing Address: Texas Instruments, Post Office Box 655303, Dallas, Texas 75265
Copyright © 2009, Texas Instruments Incorporated

IMPORTANT NOTICE

Texas Instruments Incorporated and its subsidiaries (TI) reserve the right to make corrections, modifications, enhancements, improvements, and other changes to its products and services at any time and to discontinue any product or service without notice. Customers should obtain the latest relevant information before placing orders and should verify that such information is current and complete. All products are sold subject to TI's terms and conditions of sale supplied at the time of order acknowledgment.

TI warrants performance of its hardware products to the specifications applicable at the time of sale in accordance with TI's standard warranty. Testing and other quality control techniques are used to the extent TI deems necessary to support this warranty. Except where mandated by government requirements, testing of all parameters of each product is not necessarily performed.

TI assumes no liability for applications assistance or customer product design. Customers are responsible for their products and applications using TI components. To minimize the risks associated with customer products and applications, customers should provide adequate design and operating safeguards.

TI does not warrant or represent that any license, either express or implied, is granted under any TI patent right, copyright, mask work right, or other TI intellectual property right relating to any combination, machine, or process in which TI products or services are used. Information published by TI regarding third-party products or services does not constitute a license from TI to use such products or services or a warranty or endorsement thereof. Use of such information may require a license from a third party under the patents or other intellectual property of the third party, or a license from TI under the patents or other intellectual property of TI.

Reproduction of TI information in TI data books or data sheets is permissible only if reproduction is without alteration and is accompanied by all associated warranties, conditions, limitations, and notices. Reproduction of this information with alteration is an unfair and deceptive business practice. TI is not responsible or liable for such altered documentation. Information of third parties may be subject to additional restrictions.

Resale of TI products or services with statements different from or beyond the parameters stated by TI for that product or service voids all express and any implied warranties for the associated TI product or service and is an unfair and deceptive business practice. TI is not responsible or liable for any such statements.

TI products are not authorized for use in safety-critical applications (such as life support) where a failure of the TI product would reasonably be expected to cause severe personal injury or death, unless officers of the parties have executed an agreement specifically governing such use. Buyers represent that they have all necessary expertise in the safety and regulatory ramifications of their applications, and acknowledge and agree that they are solely responsible for all legal, regulatory and safety-related requirements concerning their products and any use of TI products in such safety-critical applications, notwithstanding any applications-related information or support that may be provided by TI. Further, Buyers must fully indemnify TI and its representatives against any damages arising out of the use of TI products in such safety-critical applications.

TI products are neither designed nor intended for use in military/aerospace applications or environments unless the TI products are specifically designated by TI as military-grade or "enhanced plastic." Only products designated by TI as military-grade meet military specifications. Buyers acknowledge and agree that any such use of TI products which TI has not designated as military-grade is solely at the Buyer's risk, and that they are solely responsible for compliance with all legal and regulatory requirements in connection with such use.

TI products are neither designed nor intended for use in automotive applications or environments unless the specific TI products are designated by TI as compliant with ISO/TS 16949 requirements. Buyers acknowledge and agree that, if they use any non-designated products in automotive applications, TI will not be responsible for any failure to meet such requirements.

Following are URLs where you can obtain information on other Texas Instruments products and application solutions:

Products

Amplifiers	amplifier.ti.com
Data Converters	dataconverter.ti.com
DLP® Products	www.dlp.com
DSP	dsp.ti.com
Clocks and Timers	www.ti.com/clocks
Interface	interface.ti.com
Logic	logic.ti.com
Power Mgmt	power.ti.com
Microcontrollers	microcontroller.ti.com
RFID	www.ti-rfid.com
RF/IF and ZigBee® Solutions	www.ti.com/lprf

Applications

Audio	www.ti.com/audio
Automotive	www.ti.com/automotive
Broadband	www.ti.com/broadband
Digital Control	www.ti.com/digitalcontrol
Medical	www.ti.com/medical
Military	www.ti.com/military
Optical Networking	www.ti.com/opticalnetwork
Security	www.ti.com/security
Telephony	www.ti.com/telephony
Video & Imaging	www.ti.com/video
Wireless	www.ti.com/wireless

Mailing Address: Texas Instruments, Post Office Box 655303, Dallas, Texas 75265
Copyright © 2009, Texas Instruments Incorporated