

QT-Brightek PLCC Series

2014 PLCC2 LED

Part No.: QBLP675-XX Series

XX = Color Code

Product: QBLP675-XX Series	Date: March 29 th , 2018	Page 1 of 12
	Version# 1.0	

Table of Contents:

Introduction	3
Electrical / Optical Characteristic (Ta=25 °C)	4
Absolute Maximum Rating	4
Characteristic Curves.....	7
Solder Profile & Footprint.....	9
Packing	10
Labeling	11
Ordering Information	11
Revision History	12
Disclaimer	12

Introduction

Feature:

- Package in tape and reel
- Water clear lens
- Ultra bright reflector type 2014 PLCC2 LED
- InGaN technology for IB/IG
- AlInGaP technology for R/AG/Y/O/S
- Viewing angle: 120 deg. Typ.

Description:

This ultra-bright 2014 LED has a height profile of 1.30mm. Combination of high brightness output and robust package, this LED is ideal for back lighting, architecture lighting, and industrial equipment lighting applications.

Application:

- Status indication
- Industrial equipment backlighting
- Architecture lighting

Certification & Compliance:

- TS16949
- ISO9001
- RoHS Compliant

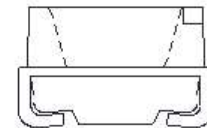
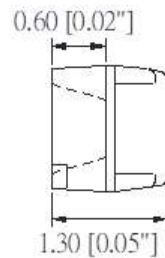
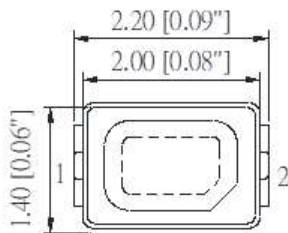
**Dimension:**

**IG (True Green) / IB (Blue) / AG (Yellow Green)
Y (Yellow) / R (Red) / O (Orange)**



S (Deep Red)

Units: mm / tolerance = +/-0.2mm

Electrical / Optical Characteristic (Ta=25 °C)

Product	Color	I _F (mA)	V _F (V)		λ _D (nm)			I _V (mcd)	
			Typ.	Max.	Min.	Typ.	Max.	Min.	Typ.
QBLP675-IB	Blue	20	3.0	3.7	460	465	470	100	195
QBLP675-IG	True Green	20	3.2	3.7	520	522	530	400	725
QBLP675-R	Red	20	2.0	2.5	615	622	630	80	139
QBLP675-AG	Yellow Green	20	2.0	2.5	565	570	576	32	51
QBLP675-Y	Yellow	20	2.0	2.5	585	587	595	63	122
QBLP675-O	Orange	20	2.0	2.5	600	605	610	80	135
QBLP675-S	Deep Red	20	2.0	2.5	630	640	650	63	119

Absolute Maximum Rating

Material	P _d (mW)	I _F (mA)	I _{FP} (mA)*	V _R (V)	T _{OP} (°C)	T _{ST} (°C)	T _{SO L} (°C)**
AllInGaP (R/AG/Y/O/S)	75	30	125	5	-40 ~ +80	-40 ~ +85	260
InGaN (IB/IG)	111	30	125	5	-40 ~ +80	-40 ~ +85	260

*Duty 1/8 @ 1KHz

**IR Reflow for no more than 10 sec @ 260 °C

Forward Voltage V_F for AllInGaP @ I_F=20mA

Bin	Min.	Max.	Unit
□	1.7	2.5	V

Forward Voltage V_F for InGaN @ I_F=20mA

Bin	Min.	Max.	Unit
e	2.5	2.8	V
f	2.8	3.1	
g	3.1	3.4	
h	3.4	3.7	

Dominant Wavelength λ_D for Blue @ $I_F=20mA$

Bin	Min.	Max.	Unit
E	460	462.5	nm
F	462.5	465	
G	465	467.5	
H	467.5	470	

Dominant Wavelength λ_D for True Green @ $I_F=20mA$

Bin	Min.	Max.	Unit
U	520	522.5	nm
V	522.5	525	
W	525	527.5	
X	527.5	530	

Dominant Wavelength λ_D for Red @ $I_F=20mA$

Bin	Min.	Max.	Unit
s	615	620	nm
t	620	625	
u	625	630	

Dominant Wavelength λ_D for Yellow Green @ $I_F=20mA$

Bin	Min.	Max.	Unit
h	565	568	nm
i	568	572	
j	572	576	

Dominant Wavelength λ_D for Yellow @ $I_F=20mA$

Bin	Min.	Max.	Unit
m	585	590	nm
n	590	595	

Dominant Wavelength λ_D for Orange @ $I_F=20mA$

Bin	Min.	Max.	Unit
p	600	605	nm
q	605	610	

Dominant Wavelength λ_D for Deep Red @ $I_F=20mA$

Bin	Min.	Max.	Unit
v	630	635	nm
w	635	650	

Luminous Intensity I_v @ $I_f=20mA$

Bin	Min.	Max.	Unit
E	32	40	mcd
F	40	50	
G	50	63	
H	63	80	
I	80	100	
J	100	125	
K	125	160	
L	160	200	
M	200	250	
N	250	320	
O	320	400	
P	400	500	
Q	500	630	
R	630	800	
S	800	1000	
T	1000	1250	

Characteristic Curves

AllnGaP (R/AG/Y/O/S)

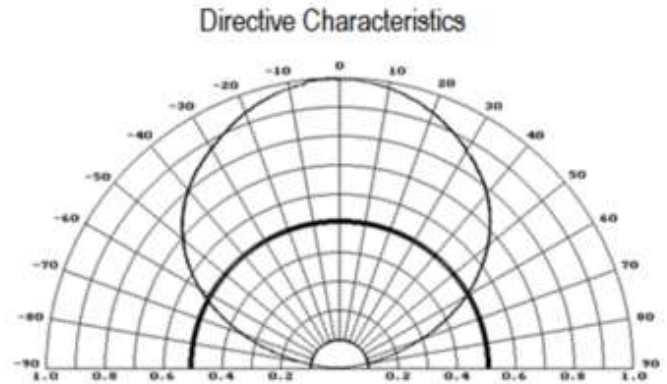
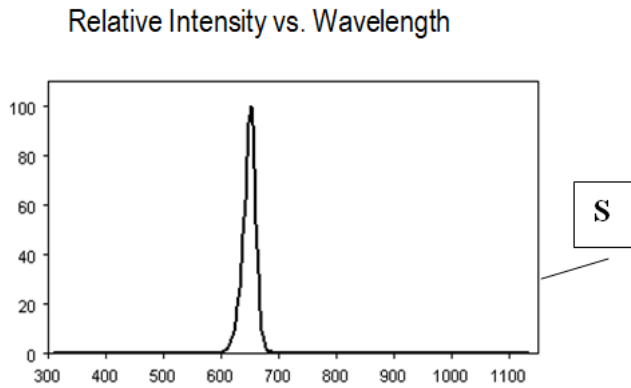
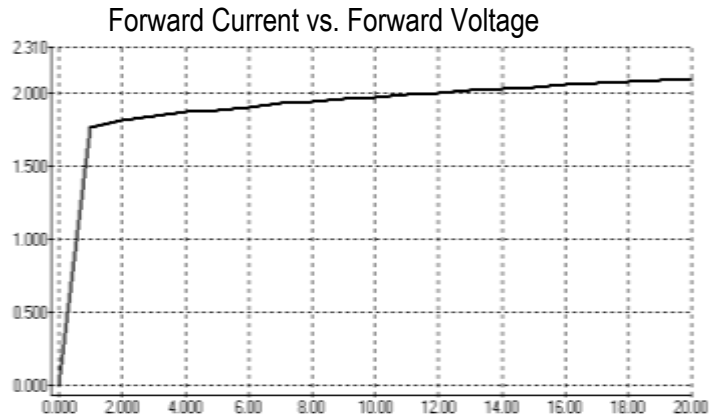
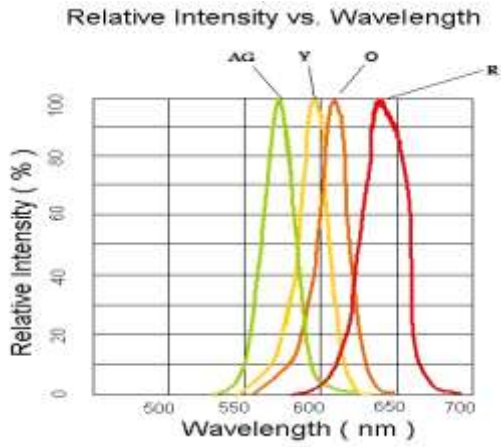

InGaN (IB/IG)

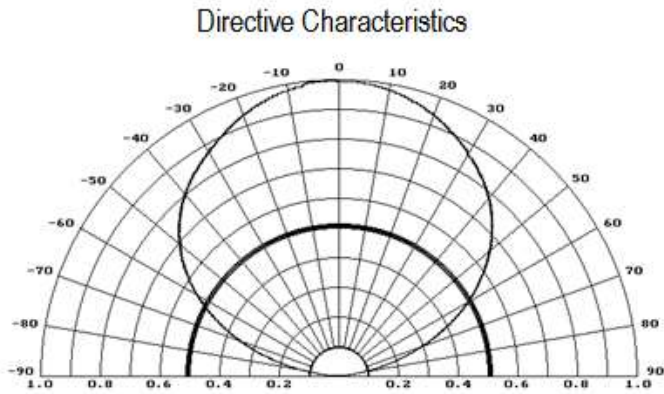
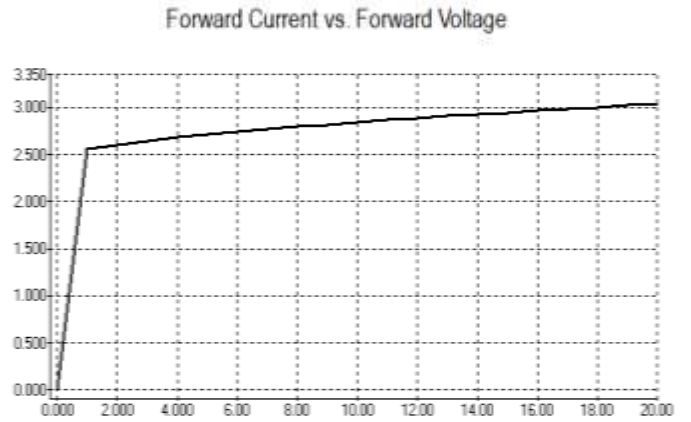
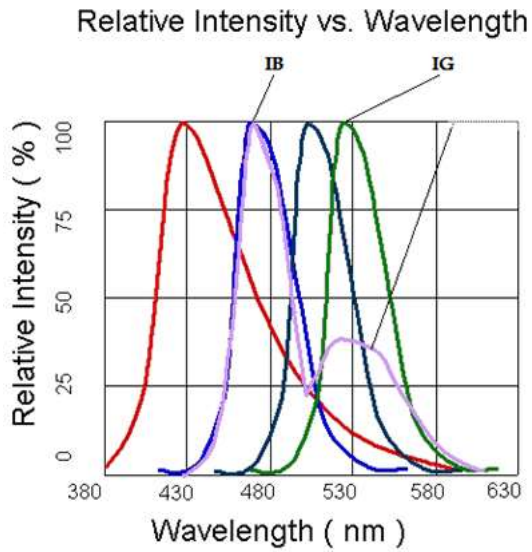

Solder Profile & Footprint

-The recommended reflow soldering profile is as follows (temperatures indicated are as measured on the surface of the LED resin):

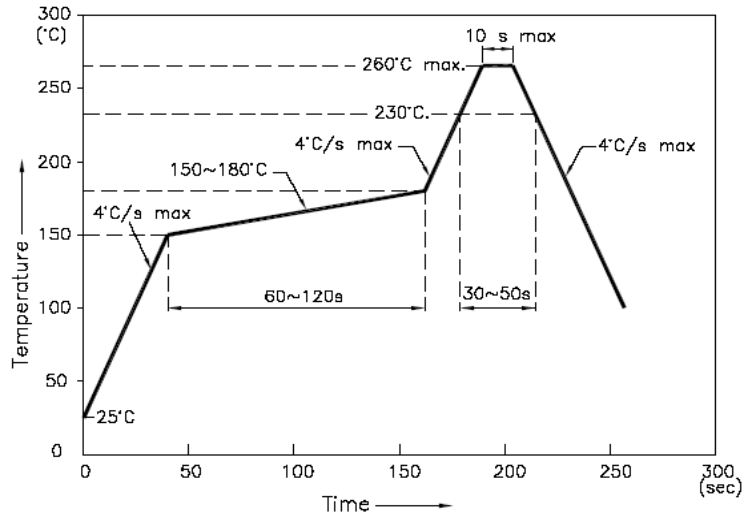

Recommended Pad Layout

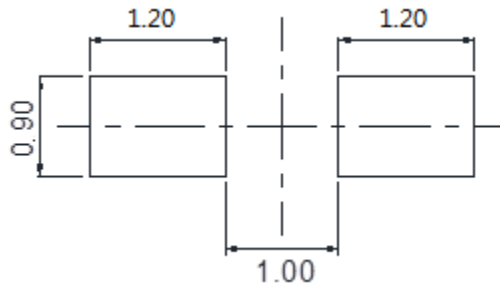

Units: mm

Packing

Reel Dimension:

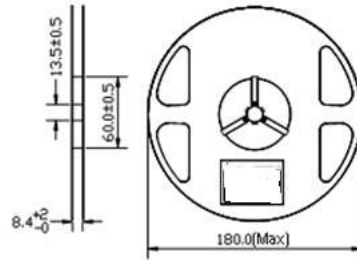

Unit: mm

Tape Dimension:

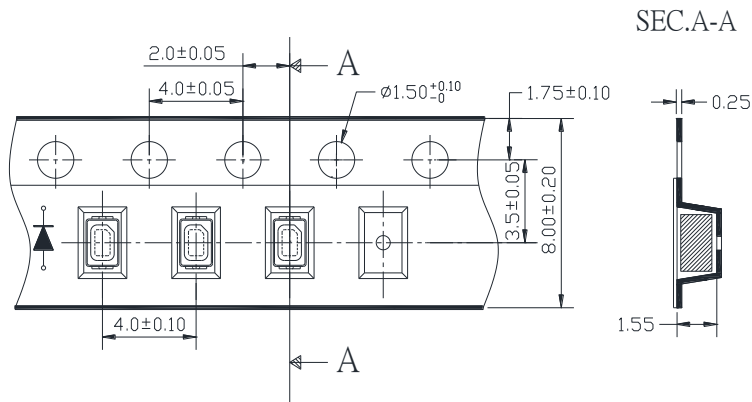

Unit: mm

Packaging Specification:

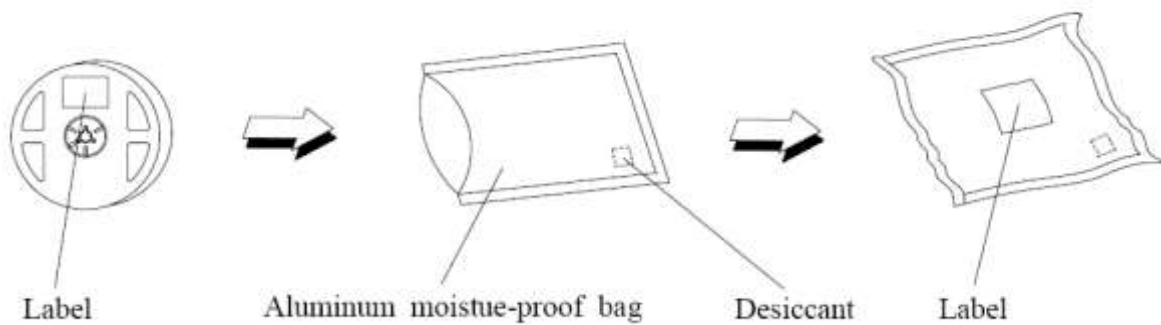

Labeling



Part No: _____

Customer P/N: _____

Item: _____

Q'ty: _____

Vf: _____

Iv: _____

Wl: _____

Date: _____

Made in China

Ordering Information

Part #	Orderable Part #	Spec Range	Quantity per reel
QBLP675-IB	QBLP675-IB	Iv=195mcd typ. @ 20mA / Color=460nm to 470nm	3,000 units
QBLP675-IG	QBLP675-IG	Iv=725mcd typ. @ 20mA / Color=520nm to 530nm	3,000 units
QBLP675-R	QBLP675-R	Iv=139mcd typ. @ 20mA / Color=615nm to 630nm	3,000 units
QBLP675-AG	QBLP675-AG	Iv=51mcd typ. @ 20mA / Color=565nm to 576nm	3,000 units
QBLP675-Y	QBLP675-Y	Iv=122mcd typ. @ 20mA / Color=585nm to 595nm	3,000 units
QBLP675-O	QBLP675-O	Iv=135mcd typ. @ 20mA / Color=600nm to 610nm	3,000 units
QBLP675-S	QBLP675-S	Iv=119mcd typ. @ 20mA / Color=630nm to 650nm	3,000 units

Revision History

Description:	Revision #	Revision Date
New Release of QBLP675_series	V1.0	03/29/2019

Disclaimer

QT-BRIGHTTEK reserves the right to make changes without further notice to any products herein to improve reliability, function or design. QT-BRIGHTTEK does not assume any liability arising out of the application or use of any product or circuit described herein; neither does it convey any license under its patent rights, nor the rights of others.

Life Support Policy

QT-BRIGHTTEK's products are not authorized for use as critical components in life support devices or systems without the express written approval of QT-BRIGHTTEK. As used herein:

1. Life support devices or systems are devices or systems which, (a) are intended for surgical implant into the body, or (b) support or sustain life, and (c) whose failure to perform when properly used in accordance with instructions for use provided in the labeling, can be reasonably expected to result in a significant injury of the user.
2. A critical component in any component of a life support device or system whose failure to perform can be reasonably expected to cause the failure of the life support device or system, or to affect its safety or effectiveness.