

TACT SWITCHES  
 NAVIGATION SWITCHES  
**PUSHBUTTON SWITCHES**  
 TOGGLE SWITCHES  
 ROCKER SWITCHES  
 SLIDE SWITCHES  
 SNAP-ACTION SWITCHES  
 DIP SWITCHES  
 KEYLOCK SWITCHES  
 ROTARY SWITCHES  
 DETECTOR SWITCHES  
 CAP OPTIONS

# SERIES D16, P16, L16 SWITCHES

## PUSHBUTTON SWITCHES - ILLUMINATED



### SPECIFICATIONS

|                               |  |
|-------------------------------|--|
| Contact Rating:               | 5A@250 VAC - UL<br>8A@125 VAC - UL, CSA<br>6A@24 VDC - UL, CSA |
| Life Expectancy (Mechanical): | 100,000 cycles   |
| Life Expectancy (Electrical): | 50,000 cycles  |
| Contact Resistance:           | 100mΩ max. typical; initial @ 2-4 VDC                          |
| Insulation Resistance:        | > 1,000MΩ  |
| Dielectric Strength:          | > 1,500 volts 1 minute<br>> 3,000 volts between poles          |
| Actuation Force:              | 300g/pole  |
| Operating Temperature:        | -20°C to 55°C  |

### FEATURES & BENEFITS

- ▶ Modular interface/contact block design
- ▶ Robust product for industrial applications
- ▶ Attractive front panel design
- ▶ Illuminated options available

### APPLICATIONS/MARKETS

- ▶ Industrial controls
- ▶ Instrumentation
- ▶ Transportation
- ▶ Telecommunications

### HOW TO ORDER

| SERIES  | MECHANICAL CONFIGURATION   | PUSHBUTTON HEAD  | CIRCUIT   | LAMP TYPE & VOLTAGE   | LAMP COLOR (WHERE APPLICABLE)                                   | LENS COLOR   |
|---|--|--|---|---|---|--|
| D16 = Solder Lug<br><br>P16 = Socket<br><br>L16 = Pilot Indicator | EE = Latching<br><br>OA = Momentary<br><br>PL* = Pilot Indicator<br><br>*For L16 (Pilot Indicator) | S1<br>S2<br>T1<br>T2<br>R*<br>R1<br><br>*R (Mushroom Head) Available for D16 & P16 Only. | 0* = Pilot Ind.<br>1** = SPDT<br>2 = DPDT<br>3 = 3PDT<br>4 = 4PDT<br><br>*For L16 only (Pilot Indicator)<br><br>**P16 available SPDT only | 0 = None<br>A<br>B<br>C<br>F<br>G<br><br>H<br>J<br>K<br><br>M<br>N<br>L<br>D<br>E | F ———   Red<br>  Grn<br><br>J ———   Red<br>  Grn<br>K ———   Yel | RED = Red<br>GRN = Green<br>BLU = Blue*<br>WHT = White*<br>ORG = Orange*<br>YEL = Yellow*<br><br>*Not Available For 'R' Mushroom Head. |

▶ ▶ ▶ **Example Ordering Number**  
D16-EE-R1-3-A-BLU

Specifications subject to change without notice. 11.16.2021



# SERIES D16 SWITCHES

## PUSHBUTTON SWITCHES - ILLUMINATED

### D16 (SOLDER LUG)

R

MUSHROOM

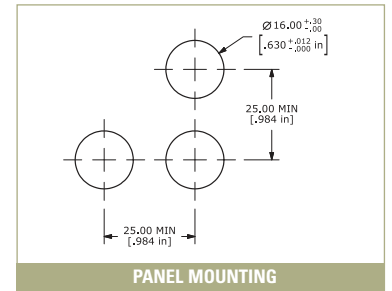
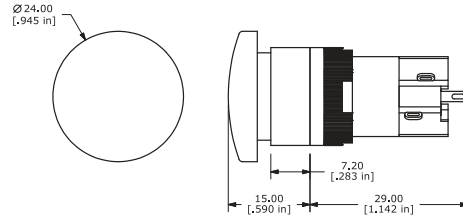

### D16 (SOLDER LUG)

R1

ROUND

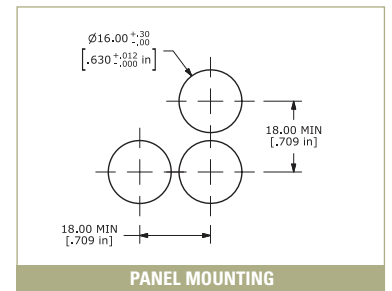
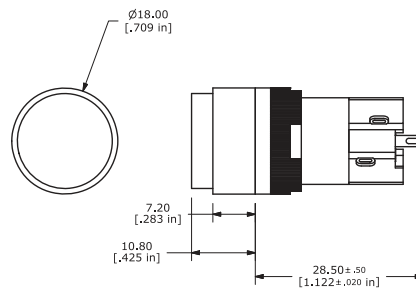

### D16 (SOLDER LUG)

S1

SQUARE

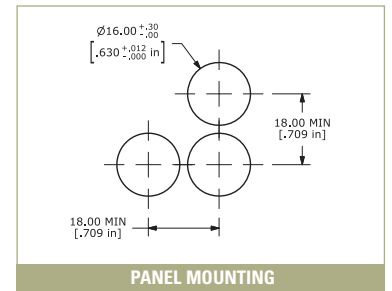
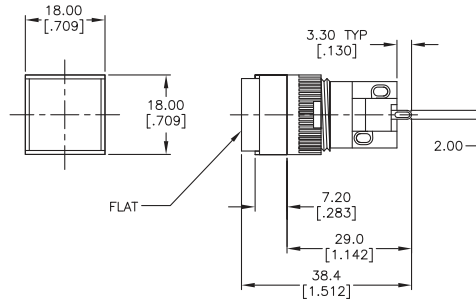

### D16 (SOLDER LUG)

T1

RECTANGULAR

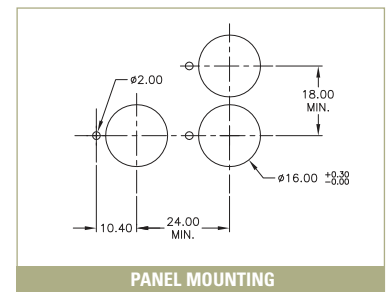
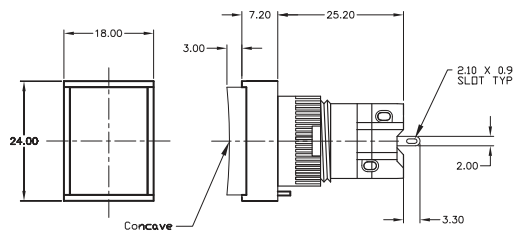

#### BOTTOM VIEW

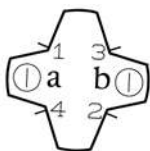

#### SCHEMATIC

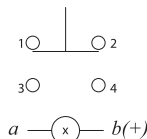

#### MOUNTING LENGTH

|      | Mounting Length (A) |
|------|---------------------|
| SPDT | 29.0 mm             |
| DPDT | 36.5 mm             |
| 3PDT | 44.0 mm             |
| 4PDT | 51.5 mm             |

# SERIES P16 SWITCHES

## PUSHBUTTON SWITCHES - ILLUMINATED

TACT SWITCHES

NAVIGATION SWITCHES

PUSHBUTTON SWITCHES

TOGGLE SWITCHES

ROCKER SWITCHES

SLIDE SWITCHES

SNAP-ACTION SWITCHES

DIP SWITCHES

KEYLOCK SWITCHES

ROTARY SWITCHES

DETECTOR SWITCHES

CAP OPTIONS

### P16 (SOCKET)

R

MUSHROOM

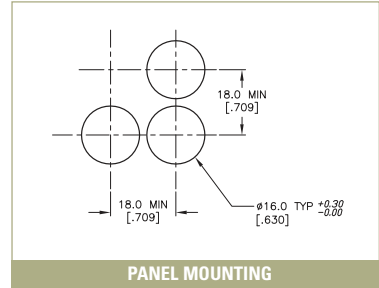
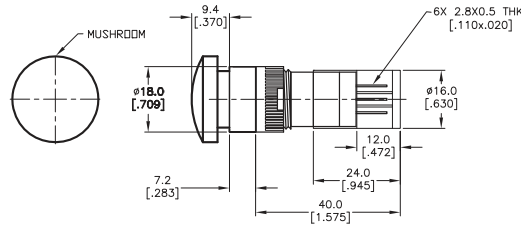

PANEL MOUNTING

### P16 (SOCKET)

R1

ROUND

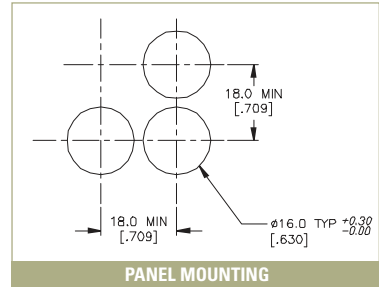
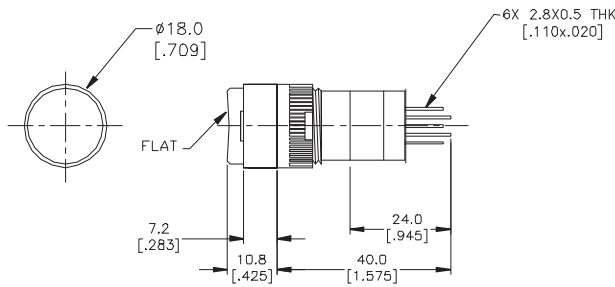

PANEL MOUNTING

### P16 (SOCKET)

S1

SQUARE

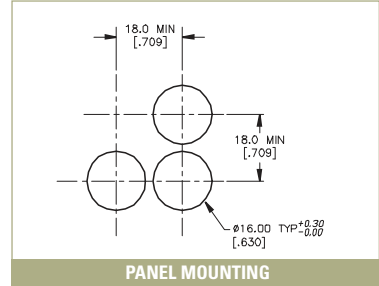
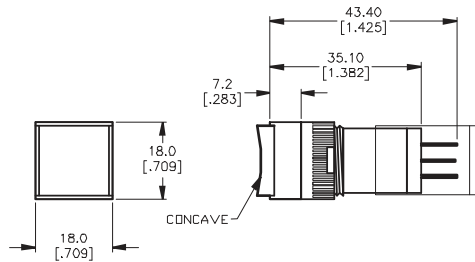

PANEL MOUNTING

### P16 (SOCKET)

T1

RECTANGULAR

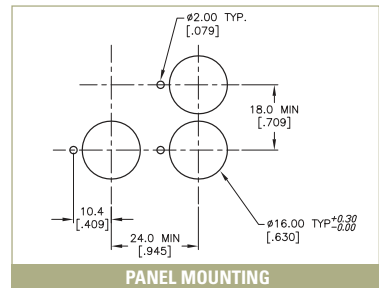
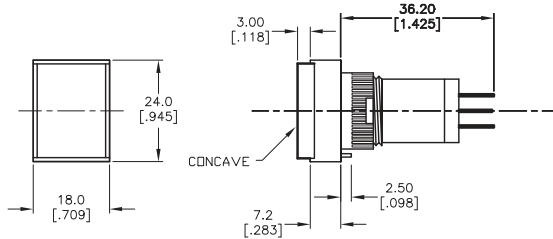

PANEL MOUNTING

### BOTTOM VIEW

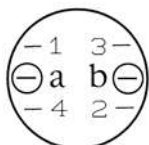

### SCHEMATIC

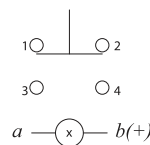



# SERIES L16 SWITCHES

## PUSHBUTTON SWITCHES - ILLUMINATED

### L16 (PILOT INDICATOR)

R1

ROUND

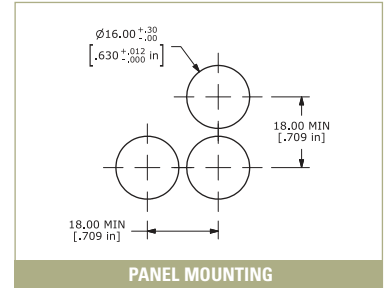
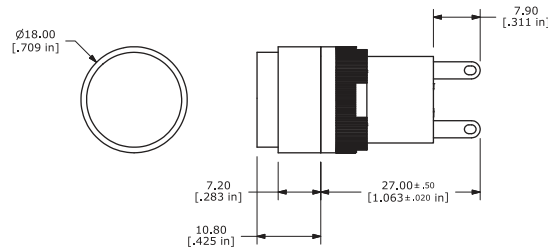

PANEL MOUNTING

### L16 (PILOT INDICATOR)

S1

SQUARE

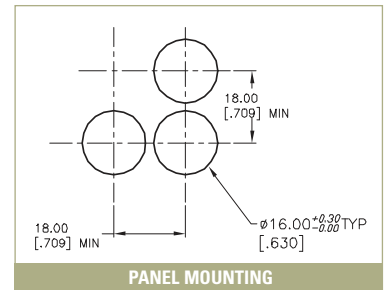
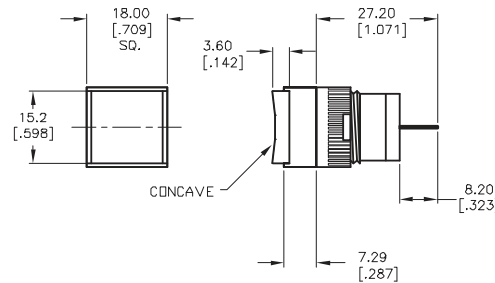

PANEL MOUNTING

### L16 (PILOT INDICATOR)

T1

RECTANGULAR

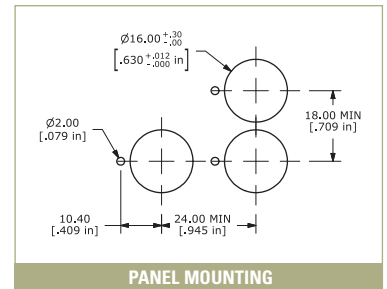
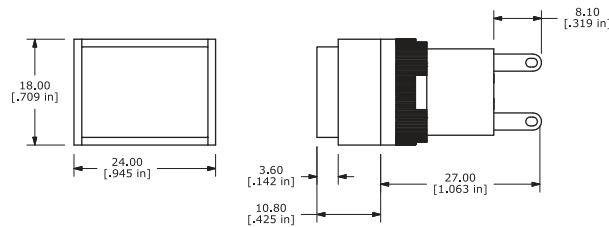

PANEL MOUNTING

#### BOTTOM VIEW

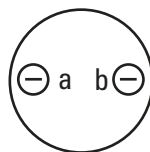

#### SCHEMATIC

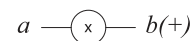



# SERIES D16, P16, L16 SWITCHES

## PUSHBUTTON SWITCHES - ILLUMINATED

TACT SWITCHES

NAVIGATION SWITCHES

PUSHBUTTON SWITCHES

TOGGLE SWITCHES

ROCKER SWITCHES

SLIDE SWITCHES

SNAP-ACTION SWITCHES

DIP SWITCHES

KEYLOCK SWITCHES

ROTARY SWITCHES

DETECTOR SWITCHES

CAP OPTIONS

### MECHANICAL CONFIGURATION & CIRCUIT OPTIONS

#### 0 PILOT INDICATOR

Available 'L16' Pilot Indicator Type



SCHEMATIC

#### 1 SPDT\*\*

Available for 'P16' Socket Type and 'D16' Solder Lug

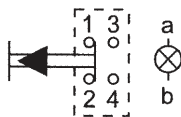

SCHEMATIC

#### 2 DPDT

Available for 'D16' Solder Lug

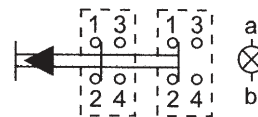

SCHEMATIC

#### 3 3PDT

Available for 'D16' Solder Lug

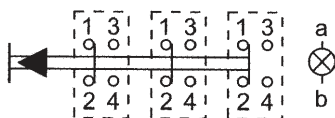

SCHEMATIC

#### 4 4PDT

Available for 'D16' Solder Lug

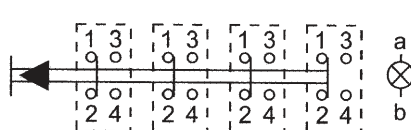

SCHEMATIC

#### Mechanical Configuration Code

|    |                  |
|----|------------------|
| EE | Latching         |
| OA | Momentary        |
| PL | Pilot Indicator* |

\*L16' Series only

### LAMP TYPE & VOLTAGE OPTIONS

| ILLUSTRATION       | CATEGORY     | DESCRIPTION         | COLOR          | PART NO.  |
|--------------------|--------------|---------------------|----------------|-----------|
|                    | Incandescent | A = 6V AC/DC 200 mA | Not Applicable | 50-004-02 |
|                    |              | B = 14V AC/DC 80 mA |                | 50-004-04 |
|                    |              | C = 28V AC/DC 40 mA |                | 50-004-05 |
|                    |              | D = 48V AC/DC 25 mA |                | 50-004-06 |
|                    |              | E = 60V AC/DC 20 mA |                | 50-004-07 |
|                    |              | L = 33V AC/DC 35 mA |                | 50-004-08 |
|                    |              | N = 14V AC/DC 40 mA |                | 50-004-03 |
| M = 6V AC/DC 40 mA | 50-004-01    |                     |                |           |
|                    | Neon         | F = 110V AC         | green          | 50-004-11 |
|                    |              |                     | red            | 50-004-12 |
|                    |              | G = 220V AC         | green          | 50-004-13 |
|                    |              |                     | red            | 50-004-14 |
|                    | LED          | H = 6V DC           | green          | 50-004-16 |
|                    |              |                     | red            | 50-004-17 |
|                    |              |                     | yellow         | 50-004-18 |
|                    |              | J = 12V DC          | green          | 50-004-19 |
|                    |              |                     | red            | 50-004-20 |
|                    |              |                     | yellow         | 50-004-21 |
| K = 24V DC         | green        | 50-004-22           |                |           |
|                    | red          | 50-004-23           |                |           |
|                    | yellow       | 50-004-24           |                |           |



| ILLUSTRATION  |  | STYLE         | SHAPE   | COLOR   | PART NO.   |
|---|--|---------------|---------|---|--|
|    | Available<br>Color Lens<br>(Acrylic Resin) | Round         | Concave | blue<br>green<br>orange<br>red<br>white<br>yellow | 50-001-01<br>50-001-02<br>50-001-03<br>50-001-04<br>50-001-05<br>50-001-06 |
|    |  | Rectangular   | Concave | blue<br>green<br>orange<br>red<br>white<br>yellow | 50-002-01<br>50-002-02<br>50-002-03<br>50-002-04<br>50-002-05<br>50-002-06 |
|    |  | Square        | Concave | blue<br>green<br>orange<br>red<br>white<br>yellow | 50-003-01<br>50-003-02<br>50-003-03<br>50-003-04<br>50-003-05<br>50-003-06 |
|  |  | Mushroom Head | Convex  | green<br>red                                      | 50-012-01<br>50-012-02   |
|  |  | Round         | Flat    | blue<br>green<br>orange<br>red<br>white<br>yellow | 50-001-11<br>50-001-12<br>50-001-13<br>50-001-14<br>50-001-15<br>50-001-16 |
|  |  | Rectangular   | Flat    | blue<br>green<br>orange<br>red<br>white<br>yellow | 50-002-11<br>50-002-12<br>50-002-13<br>50-002-14<br>50-002-15<br>50-002-16 |
|  |  | Square        | Flat    | blue<br>green<br>orange<br>red<br>white<br>yellow | 50-003-11<br>50-003-12<br>50-003-13<br>50-003-14<br>50-003-15<br>50-003-16 |

TACT SWITCHES

NAVIGATION SWITCHES

PUSHBUTTON SWITCHES

TOGGLE SWITCHES

ROCKER SWITCHES

SLIDE SWITCHES

SNAP-ACTION SWITCHES

DIP SWITCHES

KEYLOCK SWITCHES

ROTARY SWITCHES

DETECTOR SWITCHES

CAP OPTIONS

# SERIES D16, P16, L16 SWITCHES

## PUSHBUTTON SWITCHES - ILLUMINATED

TACT SWITCHES

NAVIGATION SWITCHES

PUSHBUTTON SWITCHES

TOGGLE SWITCHES

ROCKER SWITCHES

SLIDE SWITCHES

SNAP-ACTION SWITCHES





DIP SWITCHES

KEYLOCK SWITCHES

ROTARY SWITCHES

DETECTOR SWITCHES

CAP OPTIONS

| ILLUSTRATION  | CATEGORY  | DESCRIPTION   | PART NO.   |
|---|---|---|--|
|    | Lamp Extractor<br>* Also available for LA Series  | Lamp removing tool  | 50-005-01  |
|    | Blanking Plate Block                              | PVC stopper to stuff the superfluous hole of the panel board  | 50-013-01  |
|    | Connector<br>* Also available for LA Series       | Insulation Socket<br>2.8 x 0.5 mm   | 50-014-01  |
|   | PCB Mounting Socket                               |    | 50-015-01  |
|  | Mounting Wrench<br>* Also available for LA Series | Use this for tightening the switch in the mounting hole   | 50-006-01  |
|  | Lens Removing Tool                                | Use this for replacing the fitted color lens  | 50-007-01  |
|  | Spray Cover                                       | Meets requirement of IP65, two pieces of transparent plastic, rectangular head  | 50-010-01  |
|  | Protection Cap                                    | To avoid faulty operation, housing for locking, transparent<br>For square head (90°)<br>For square head (180°)<br>For rectangular head (90°)<br>For rectangular head (180°) | 50-011-01<br>50-011-11<br>50-011-02<br>50-011-12 |