

Ceramic Bandpass Filter

BFCN-4100+

50Ω 3700 to 4500 MHz

The Big Deal

- Flat group delay (± 45 pS)
- Narrow band/fast roll-off in LTCC
- Good passband VSWR (1.2:1 typical)



CASE STYLE: FV1206

Product Overview

The BFCN-4100+ LTCC Bandpass Filter is constructed using multilayer ceramic technology to achieve miniature size and high repeatability of performance. Wrap-around terminations minimize variations in performance due to parasitics. Covering 4100 MHz \pm 400 MHz, these units offer low insertion loss and good rejection at the band reject edges.

Key Features

Feature	Advantages
Flat group delay (± 45 pS)	The model has flat group delay which ensures low distortion.
Sharp shape factor	Sharp shape factor helps in adjacent channel rejection and hence increased selectivity.
Good VSWR, 1.2:1 typical over passband	This provides well matched input and output ports.
Wrap around termination	Provides excellent solderability and easy visual inspection capability.
LTCC construction	Provides a rugged package that is well suited for tough environments including high humidity and high temperature extremes.
Small size, 0.12" x 0.6" x 0.4"	The surface mount package enables BFCN-4100+ to be used in compact designs.

Notes

- A. Performance and quality attributes and conditions not expressly stated in this specification document are intended to be excluded and do not form a part of this specification document.
B. Electrical specifications and performance data contained in this specification document are based on Mini-Circuit's applicable established test performance criteria and measurement instructions.
C. The parts covered by this specification document are subject to Mini-Circuits standard limited warranty and terms and conditions (collectively, "Standard Terms"); Purchasers of this part are entitled to the rights and benefits contained therein. For a full statement of the Standard Terms and the exclusive rights and remedies thereunder, please visit Mini-Circuits' website at www.minicircuits.com/MCLStore/terms.jsp



Bandpass Filter

BFCN-4100+

50Ω 3700 to 4500 MHz



Generic photo used for illustration purposes only

CASE STYLE: FV1206

Features

- Small size, 0.12" x 0.06"
- Temperature stable
- Hermetically sealed
- LTCC construction

Applications

- Harmonic rejection
- Transmitters / receivers

Electrical Specifications^{1,2} at 25°C

Parameter	F#	Frequency (MHz)	Min.	Typ.	Max.	Unit	
Pass Band	Center Frequency	—	—	4100	—	MHz	
	Insertion Loss	F1-F2	3700 - 4500	—	1.4	2.0	dB
	VSWR	F1-F2	3700 - 4500	—	1.5	2.0	:1
Stop Band, Lower	Insertion Loss	DC-F3	DC - 2200	20	25	—	dB
	VSWR	DC-F3	DC - 2200	—	25	—	:1
Stop Band, Upper	Insertion Loss	F4-F5	6000 - 9000	15	20	—	dB
	VSWR	F4-F5	6000 - 9000	—	20	—	:1

1. Measured on Mini-Circuits Characterization Test Board TB-270.

2. This filter is not intended for use as a DC Blocking circuit element. In Application where DC voltage is present at either input or output ports, blocking capacitors are required at the corresponding RF port.

Maximum Ratings

Operating Temperature	-55°C to 100°C
Storage Temperature	-55°C to 100°C
RF Power Input	1.5W max.

Permanent damage may occur if any of these limits are exceeded.

Functional Schematic

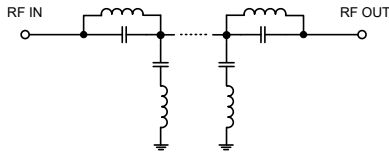

Typical Frequency Response

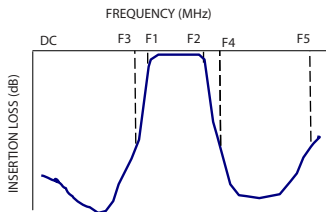

Typical Performance Data at 25°C

Frequency (MHz)	Insertion Loss (dB)	VSWR (:1)	Frequency (MHz)	Group Delay (nsec)
10.00	103.46	20111.00	3700.00	0.67
60.00	79.31	5792.02	3750.00	0.65
100.00	73.31	8202.75	3810.00	0.63
320.00	65.61	729.17	3870.00	0.61
1000.00	54.23	170.92	4000.00	0.59
1510.00	38.59	88.11	4060.00	0.58
2040.00	28.17	59.32	4130.00	0.58
3020.00	11.07	16.83	4190.00	0.58
3310.00	5.55	6.15	4250.00	0.58
3750.00	1.26	1.25	4320.00	0.59
4000.00	1.08	1.08	4380.00	0.59
4510.00	1.33	1.39	4440.00	0.60
4700.00	1.66	1.69	4510.00	0.61
5010.00	3.71	3.38		
6000.00	28.93	28.70		
7080.00	29.82	19.52		
8110.00	27.11	20.57		
9000.00	21.43	19.72		
10000.00	19.39	22.84		

+RoHS Compliant

The +Suffix identifies RoHS Compliance. See our web site for RoHS Compliance methodologies and qualifications



Available Tape and Reel at no extra cost

Reel Size	Devices/Reel
7"	20, 50, 100, 200, 500, 1000, 3000

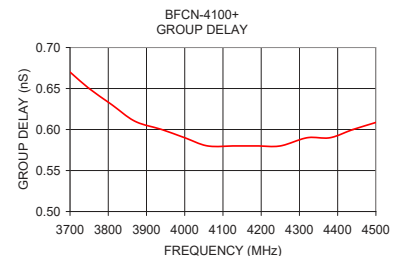
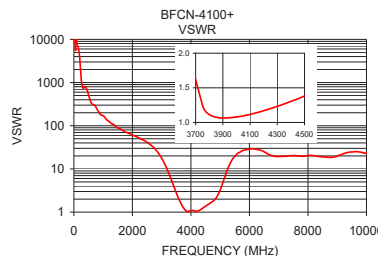
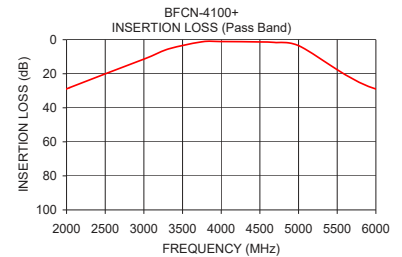
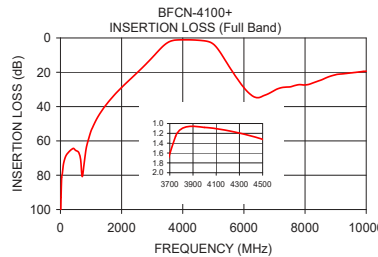

Notes

- Performance and quality attributes and conditions not expressly stated in this specification document are intended to be excluded and do not form a part of this specification document.
- Electrical specifications and performance data contained in this specification document are based on Mini-Circuit's applicable established test performance criteria and measurement instructions.
- The parts covered by this specification document are subject to Mini-Circuits standard limited warranty and terms and conditions (collectively, "Standard Terms"); Purchasers of this part are entitled to the rights and benefits contained therein. For a full statement of the Standard Terms and the exclusive rights and remedies thereunder, please visit Mini-Circuits' website at www.minicircuits.com/WCLStore/terms.jsp



Pin Connections

RF IN	1
RF OUT	3
GROUND	2,4

Demo Board MCL P/N: TB-270
Suggested PCB Layout (PL-137)

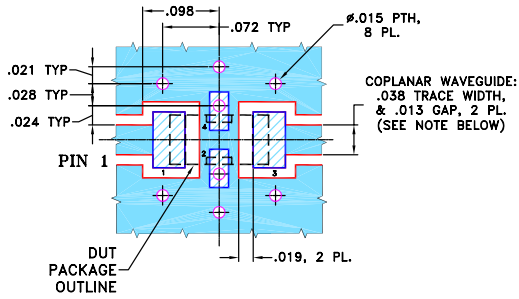

NOTES: 1. COPLANAR WAVEGUIDE PARAMETERS ARE SHOWN FOR ROGERS RO4350B WITH THICKNESS $.020" \pm .0015"$. COPPER: 1/2 OZ. EACH SIDE. FOR OTHER MATERIALS TRACE WIDTH & GAP MAY NEED TO BE MODIFIED.

2. BOTTOM SIDE OF THE PCB IS CONTINUOUS GROUND PLANE.

DENOTES PCB COPPER LAYOUT WITH SMOBC (SOLDER MASK OVER BARE COPPER)

DENOTES COPPER LAND PATTERN FREE OF SOLDER MASK

Product Marking: AZ

Outline Drawing

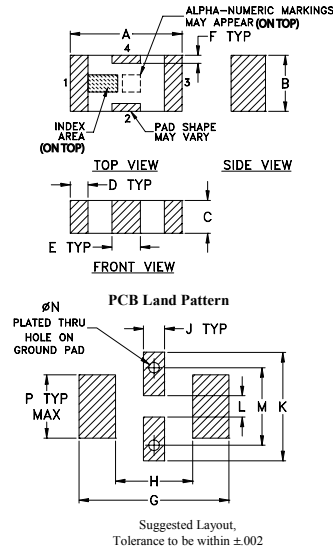

Outline Dimensions (inch mm)

A	B	C	D	E	F	G	
.126	.063	.037	.020	.032	.009	.169	
3.20	1.60	0.94	0.51	0.81	0.23	4.29	
H	J	K	L	M	N	P	wt
.087	.024	.122	.024	.087	.012	.071	grams
2.21	0.61	3.10	0.61	2.21	0.30	1.80	.020

Notes

- Performance and quality attributes and conditions not expressly stated in this specification document are intended to be excluded and do not form a part of this specification document.
- Electrical specifications and performance data contained in this specification document are based on Mini-Circuit's applicable established test performance criteria and measurement instructions.
- The parts covered by this specification document are subject to Mini-Circuits standard limited warranty and terms and conditions (collectively, "Standard Terms"); Purchasers of this part are entitled to the rights and benefits contained therein. For a full statement of the Standard Terms and the exclusive rights and remedies thereunder, please visit Mini-Circuits' website at www.minicircuits.com/MCLStore/terms.jsp