

TOLERANCE UNLESS OTHERWISE SPECIFIED	
.X	±0.35
.XX	±0.25
.XXX	±0.15

THIS IS A C.A.D. GENERATED DRAWING
DO NOT MAKE MANUAL REVISIONS TO MASTER.

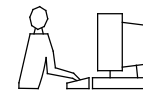

NOTES:

MATERIAL:
HOUSING:
CONTACT:

LCP +30% GLASS REINFORCED, UL94V-0
COPPER ALLOY
GOLD FLASH PLATING 80~160µ" ON SOLDER
TAIL OVER NICKEL 50~150µ" UNDER PLATING

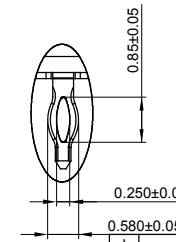
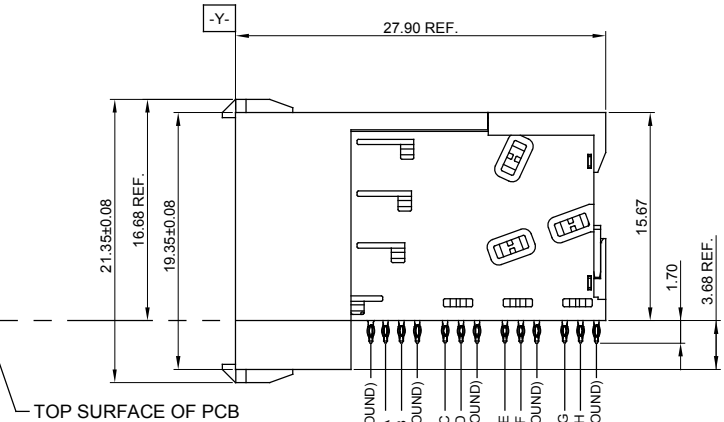
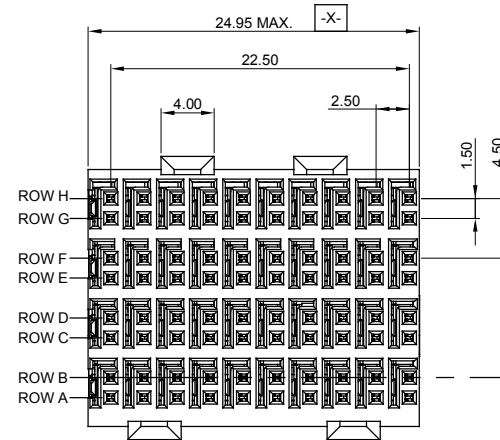
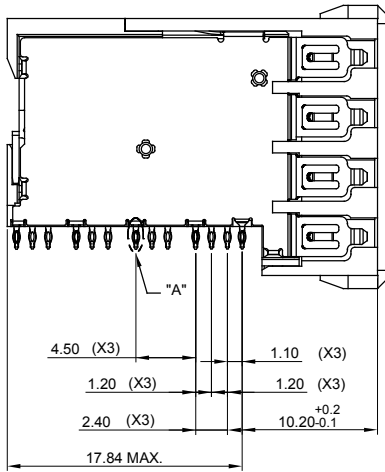
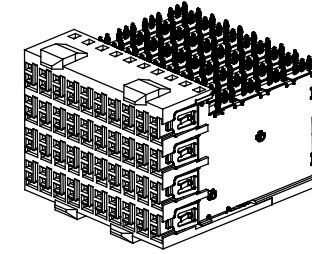
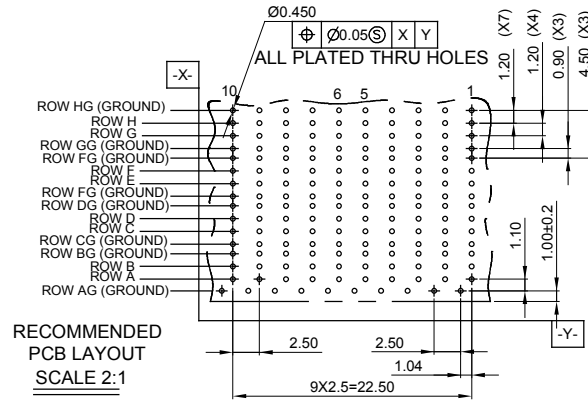
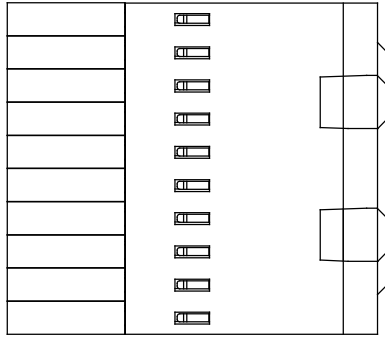

DETAIL A SCALE 10:1

ZD+ CONNECTOR, FEMALE, RIGHT ANGLE, 4 PAIR

ACAD REFERENCE NO.: 500-080-225-F02

DRAWN: W.T

DATE: JUNE.27 /2018

CHECKED:

DATE:

SCALE: N.T.S

SHEET 1 OF 1

DRAWING NUMBER: 500-080-225-F02

ISSUE

PART NUMBER: 500-080-225-F02

1



THIS SERIES FULLY CONFORMS TO THE EUROPEAN UNION DIRECTIVES 2011/65/EU FOR RoHS COMPLIANCY.



EDAC INC
TORONTO, ONTARIO
CANADA
YOUR CONNECTION TO QUALITY & SERVICE

THESE DRAWINGS AND SPECIFICATIONS ARE THE PROPERTY OF EDAC INC., AND SHALL NOT BE REPRODUCED, OR COPIED OR USED AS THE BASIS FOR THE MANUFACTURE OR SALE OF APPARATUS WITHOUT WRITTEN PERMISSION.