

**Cool MOS™ Power Transistor**
**Feature**

- New revolutionary high voltage technology
- Ultra low gate charge
- Periodic avalanche rated
- Extreme dv/dt rated
- High peak current capability
- Improved transconductance
- Qualified according to JEDEC<sup>0)</sup> for target applications

$V_{DS} @ T_{jmax}$	650	V
$R_{DS(on)}$	0.6	$\Omega$
$I_D$	7.3	A

PG-TO263

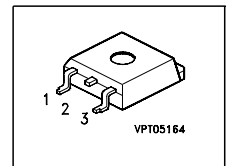

Type	Package	Ordering Code	Marking
SPB07N60C3	PG-TO263	Q67040-S4394	07N60C3

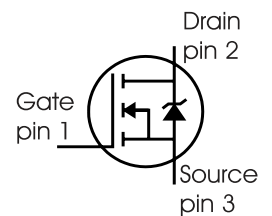
**Maximum Ratings**

Parameter	Symbol	Value		Unit
		SPB		
Continuous drain current $T_C = 25\text{ }^\circ\text{C}$ $T_C = 100\text{ }^\circ\text{C}$	$I_D$	7.3 4.6		A
Pulsed drain current, $t_p$ limited by $T_{jmax}$	$I_{D\text{ puls}}$	21.9		A
Avalanche energy, single pulse $I_D=5.5\text{A}, V_{DD}=50\text{V}$	$E_{AS}$	230		mJ
Avalanche energy, repetitive $t_{AR}$ limited by $T_{jmax}$ <sup>2)</sup> $I_D=7.3\text{A}, V_{DD}=50\text{V}$	$E_{AR}$	0.5		
Avalanche current, repetitive $t_{AR}$ limited by $T_{jmax}$	$I_{AR}$	7.3		A
Gate source voltage static	$V_{GS}$	$\pm 20$		V
Gate source voltage AC ( $f > 1\text{Hz}$ )	$V_{GS}$	$\pm 30$		
Power dissipation, $T_C = 25\text{ }^\circ\text{C}$	$P_{tot}$	83		W
Operating and storage temperature	$T_j, T_{stg}$	-55...+150		$^\circ\text{C}$
Reverse diode dv/dt <sup>6)</sup>	dv/dt	15		V/ns

**Maximum Ratings**

Parameter	Symbol	Value	Unit
Drain Source voltage slope $V_{DS} = 480\text{ V}$ , $I_D = 7.3\text{ A}$ , $T_j = 125\text{ °C}$	$dv/dt$	50	V/ns

**Thermal Characteristics**

Parameter	Symbol	Values			Unit
		min.	typ.	max.	
Thermal resistance, junction - case	$R_{thJC}$	-	-	1.5	K/W
Thermal resistance, junction - case, FullPAK	$R_{thJC\text{ FP}}$	-	-	3.9	
Thermal resistance, junction - ambient, leaded	$R_{thJA}$	-	-	62	
Thermal resistance, junction - ambient, FullPAK	$R_{thJA\text{ FP}}$	-	-	80	
SMD version, device on PCB: @ min. footprint @ 6 cm <sup>2</sup> cooling area <sup>3)</sup>	$R_{thJA}$	-	-	62	
		-	35	-	
Soldering temperature, reflow soldering, MSL1 1.6 mm (0.063 in.) from case for 10s	$T_{sold}$	-	-	260	°C

**Electrical Characteristics, at  $T_j=25\text{ °C}$  unless otherwise specified**

Parameter	Symbol	Conditions	Values			Unit
			min.	typ.	max.	
Drain-source breakdown voltage	$V_{(BR)DSS}$	$V_{GS}=0\text{V}$ , $I_D=0.25\text{mA}$	600	-	-	V
Drain-Source avalanche breakdown voltage	$V_{(BR)DS}$	$V_{GS}=0\text{V}$ , $I_D=7.3\text{A}$	-	700	-	
Gate threshold voltage	$V_{GS(th)}$	$I_D=350\mu\text{A}$ , $V_{GS}=V_{DS}$	2.1	3	3.9	
Zero gate voltage drain current	$I_{DSS}$	$V_{DS}=600\text{V}$ , $V_{GS}=0\text{V}$ , $T_j=25\text{ °C}$ $T_j=150\text{ °C}$	-	0.5	1	μA
			-	-	100	
Gate-source leakage current	$I_{GSS}$	$V_{GS}=30\text{V}$ , $V_{DS}=0\text{V}$	-	-	100	nA
Drain-source on-state resistance	$R_{DS(on)}$	$V_{GS}=10\text{V}$ , $I_D=4.6\text{A}$ $T_j=25\text{ °C}$ $T_j=150\text{ °C}$	-	0.54	0.6	Ω
			-	1.46	-	
Gate input resistance	$R_G$	$f=1\text{MHz}$ , open drain	-	0.8	-	

**Electrical Characteristics, at  $T_j = 25^\circ\text{C}$ , unless otherwise specified**

Parameter	Symbol	Conditions	Values			Unit
			min.	typ.	max.	
<b>Characteristics</b>						
Transconductance	$g_{fs}$	$V_{DS} \geq 2 \cdot I_D \cdot R_{DS(on)max}$ , $I_D = 4.6\text{A}$	-	6	-	S
Input capacitance	$C_{iss}$	$V_{GS} = 0\text{V}$ , $V_{DS} = 25\text{V}$ , $f = 1\text{MHz}$	-	790	-	pF
Output capacitance	$C_{oss}$		-	260	-	
Reverse transfer capacitance	$C_{rss}$		-	16	-	
Effective output capacitance, <sup>4)</sup> energy related	$C_{o(er)}$	$V_{GS} = 0\text{V}$ , $V_{DS} = 0\text{V to } 480\text{V}$	-	30	-	
Effective output capacitance, <sup>5)</sup> time related	$C_{o(tr)}$		-	55	-	
Turn-on delay time	$t_{d(on)}$	$V_{DD} = 380\text{V}$ , $V_{GS} = 0/13\text{V}$ , $I_D = 7.3\text{A}$ , $R_G = 12\Omega$ , $T_j = 125^\circ\text{C}$	-	6	-	ns
Rise time	$t_r$		-	3.5	-	
Turn-off delay time	$t_{d(off)}$		-	60	100	
Fall time	$t_f$		-	7	15	

**Gate Charge Characteristics**

Gate to source charge	$Q_{gs}$	$V_{DD} = 480\text{V}$ , $I_D = 7.3\text{A}$	-	3	-	nC
Gate to drain charge	$Q_{gd}$		-	9.2	-	
Gate charge total	$Q_g$	$V_{DD} = 480\text{V}$ , $I_D = 7.3\text{A}$ , $V_{GS} = 0 \text{ to } 10\text{V}$	-	21	27	
Gate plateau voltage	$V_{(plateau)}$	$V_{DD} = 480\text{V}$ , $I_D = 7.3\text{A}$	-	5.5	-	V

<sup>0</sup>J-STD20 and JESD22

<sup>1</sup>Limited only by maximum temperature

<sup>2</sup>Repetitive avalanche causes additional power losses that can be calculated as  $P_{AV} = E_{AR} \cdot f$ .

<sup>3</sup>Device on 40mm\*40mm\*1.5mm epoxy PCB FR4 with 6cm<sup>2</sup> (one layer, 70 μm thick) copper area for drain connection. PCB is vertical without blown air.

<sup>4</sup> $C_{o(er)}$  is a fixed capacitance that gives the same stored energy as  $C_{oss}$  while  $V_{DS}$  is rising from 0 to 80%  $V_{DSS}$ .

<sup>5</sup> $C_{o(tr)}$  is a fixed capacitance that gives the same charging time as  $C_{oss}$  while  $V_{DS}$  is rising from 0 to 80%  $V_{DSS}$ .

<sup>6</sup> $I_{SD} \leq I_D$ ,  $di/dt \leq 400\text{A}/\mu\text{s}$ ,  $V_{DClink} = 400\text{V}$ ,  $V_{peak} < V_{BR, DSS}$ ,  $T_j < T_{j,max}$ .

Identical low-side and high-side switch.

**Electrical Characteristics**

Parameter	Symbol	Conditions	Values			Unit
			min.	typ.	max.	
Inverse diode continuous forward current	$I_S$	$T_C=25^\circ\text{C}$	-	-	7.3	A
Inverse diode direct current, pulsed	$I_{SM}$		-	-	21.9	
Inverse diode forward voltage	$V_{SD}$	$V_{GS}=0\text{V}, I_F=I_S$	-	1	1.2	V
Reverse recovery time	$t_{rr}$	$V_R=480\text{V}, I_F=I_S,$	-	400	600	ns
Reverse recovery charge	$Q_{rr}$	$di_F/dt=100\text{A}/\mu\text{s}$	-	4	-	$\mu\text{C}$
Peak reverse recovery current	$I_{rrm}$		-	28	-	A
Peak rate of fall of reverse recovery current	$di_{rr}/dt$	$T_j=25^\circ\text{C}$	-	800	-	$\text{A}/\mu\text{s}$

**Typical Transient Thermal Characteristics**

Symbol	Value		Unit	Symbol	Value		Unit
	SPB				SPB		
$R_{th1}$	0.024		K/W	$C_{th1}$	0.00012		Ws/K
$R_{th2}$	0.046			$C_{th2}$	0.0004578		
$R_{th3}$	0.085			$C_{th3}$	0.000645		
$R_{th4}$	0.308			$C_{th4}$	0.001867		
$R_{th5}$	0.317			$C_{th5}$	0.004795		
$R_{th6}$	0.112			$C_{th6}$	0.045		

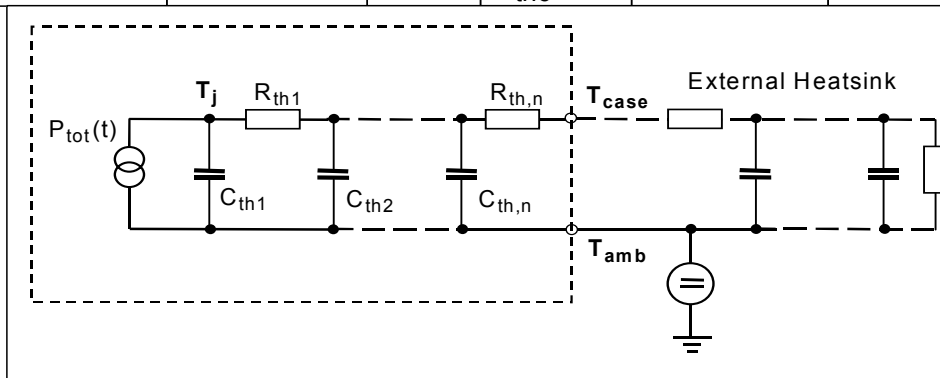

**1 Power dissipation**

$P_{tot} = f(T_C)$

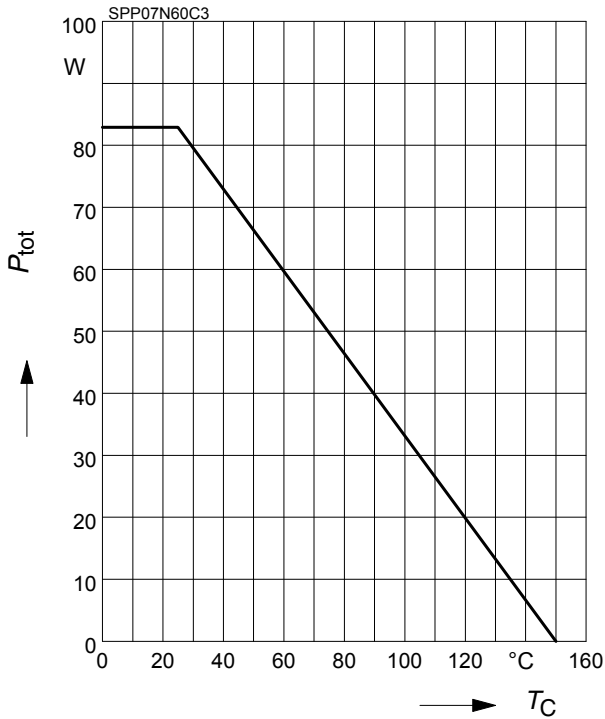

**2 Power dissipation FullPAK**

$P_{tot} = f(T_C)$

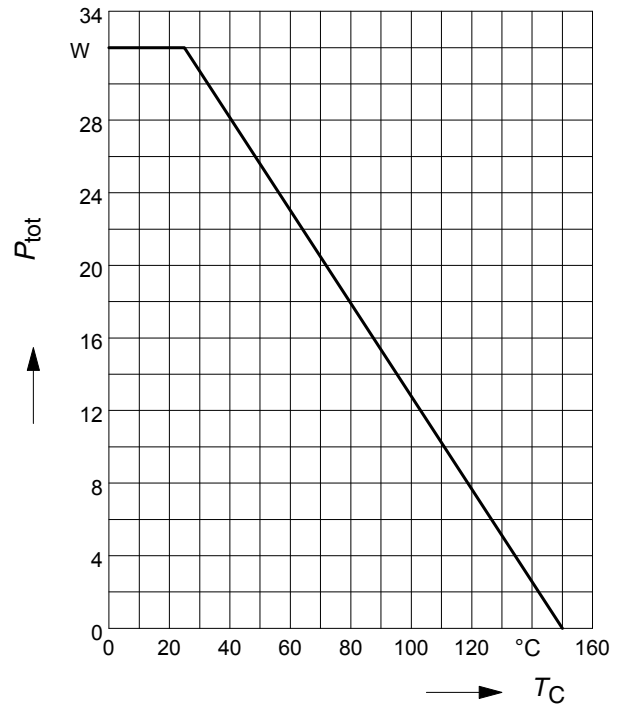

**3 Safe operating area**

$I_D = f(V_{DS})$

parameter :  $D = 0$  ,  $T_C = 25^\circ\text{C}$

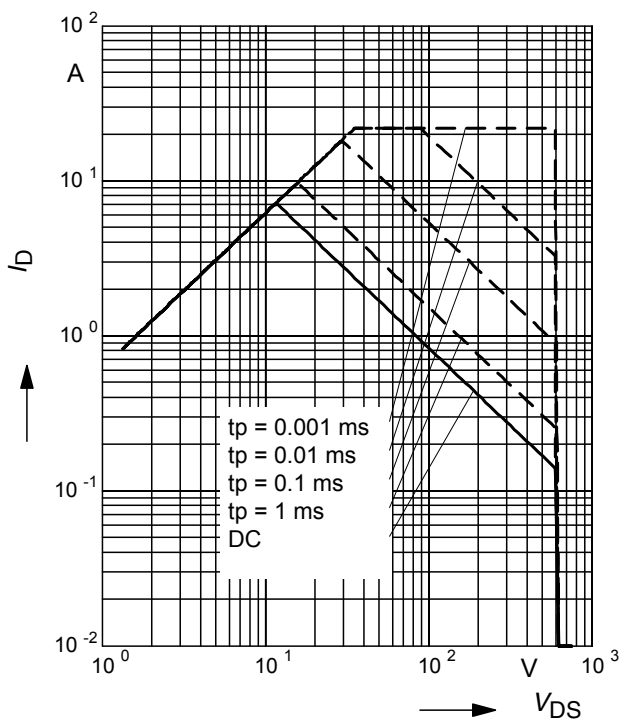

**4 Safe operating area FullPAK**

$I_D = f(V_{DS})$

parameter:  $D = 0$  ,  $T_C = 25^\circ\text{C}$

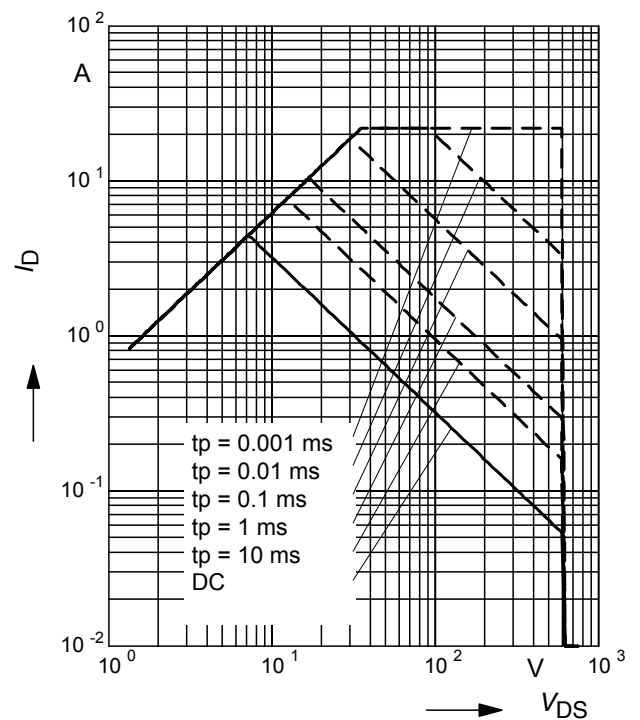

**5 Transient thermal impedance**

$Z_{thJC} = f(t_p)$

parameter:  $D = t_p/T$

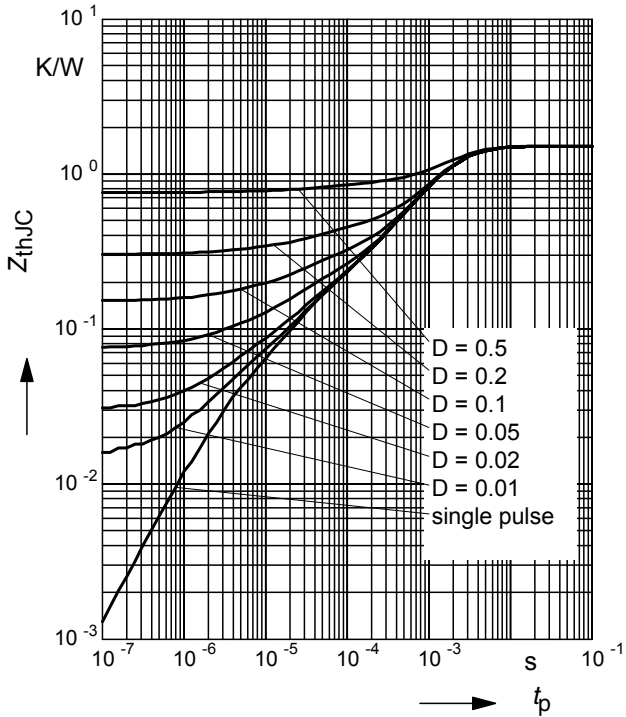

**6 Transient thermal impedance FullPAK**

$Z_{thJC} = f(t_p)$

parameter:  $D = t_p/t$

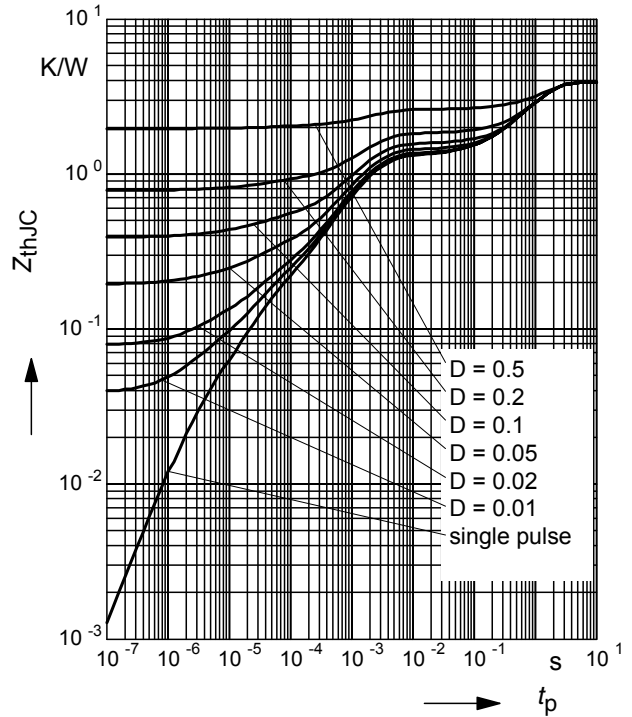

**7 Typ. output characteristic**

$I_D = f(V_{DS}); T_j = 25^\circ C$

parameter:  $t_p = 10 \mu s, V_{GS}$

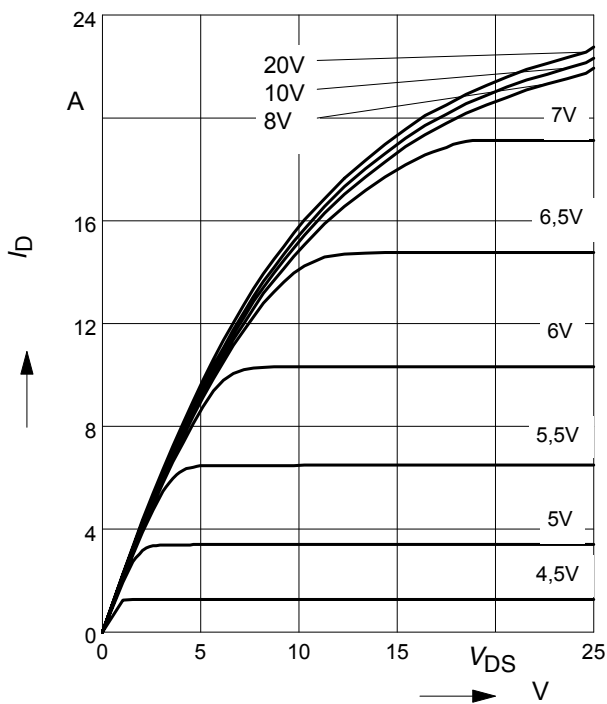

**8 Typ. output characteristic**

$I_D = f(V_{DS}); T_j = 150^\circ C$

parameter:  $t_p = 10 \mu s, V_{GS}$

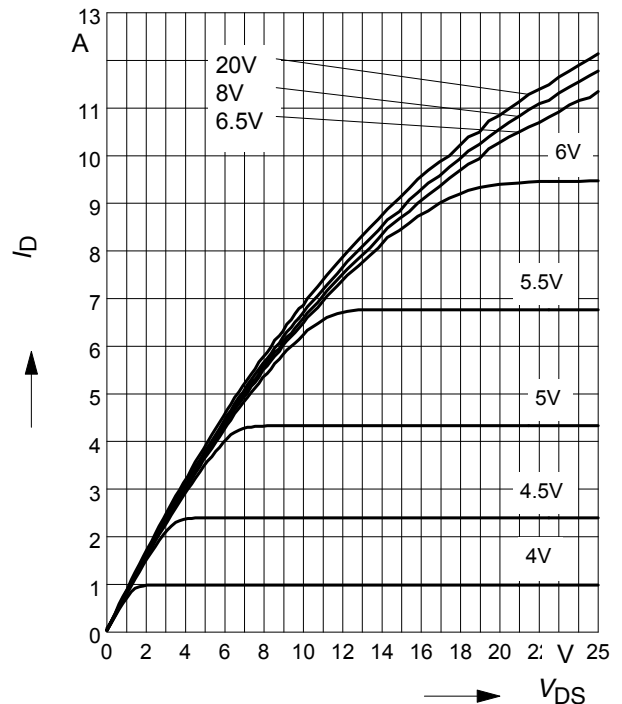

**9 Typ. drain-source on resistance**

$$R_{DS(on)} = f(I_D)$$

parameter:  $T_j = 150^\circ\text{C}$ ,  $V_{GS}$

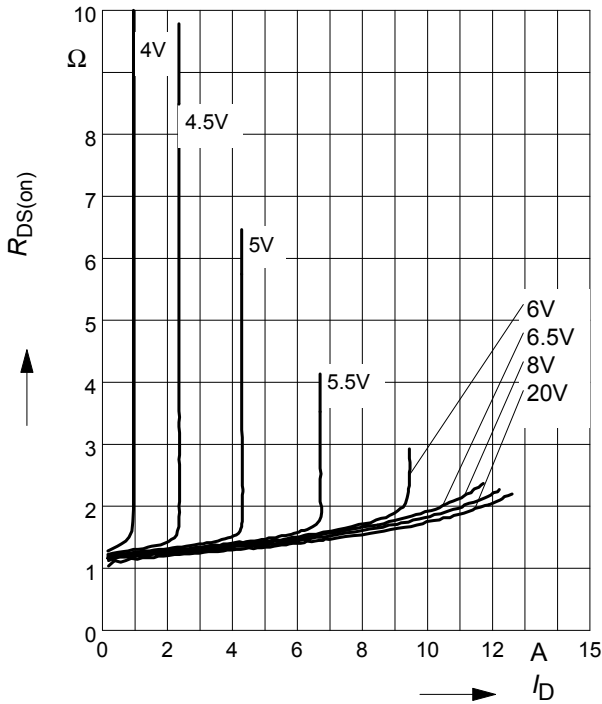

**10 Drain-source on-state resistance**

$$R_{DS(on)} = f(T_j)$$

parameter:  $I_D = 4.6\text{ A}$ ,  $V_{GS} = 10\text{ V}$

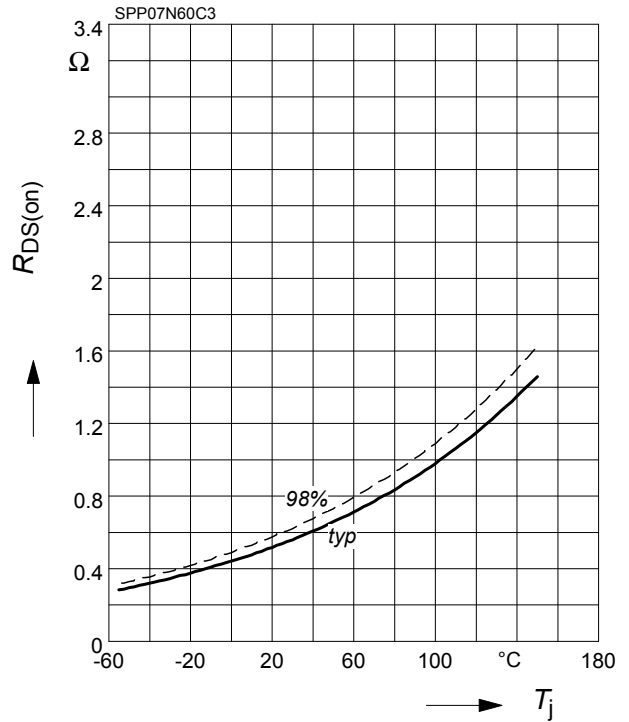

**11 Typ. transfer characteristics**

$$I_D = f(V_{GS}); V_{DS} \geq 2 \times I_D \times R_{DS(on)max}$$

parameter:  $t_p = 10\ \mu\text{s}$

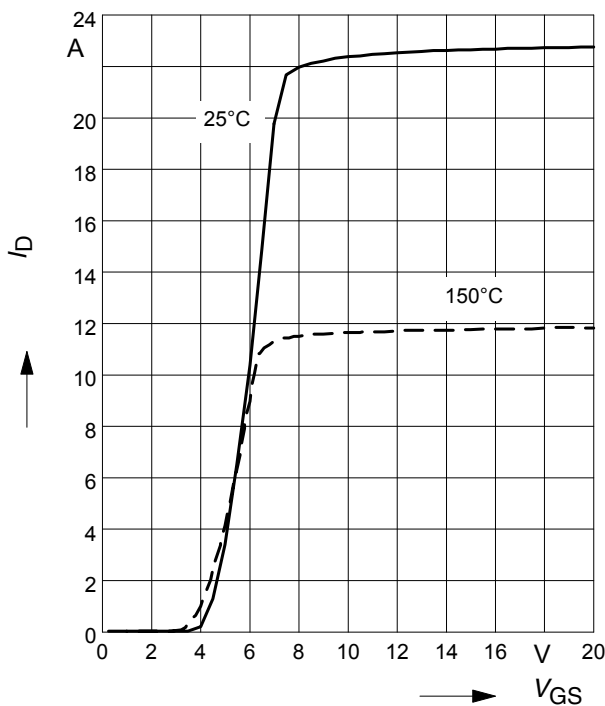

**12 Typ. gate charge**

$$V_{GS} = f(Q_{Gate})$$

parameter:  $I_D = 7.3\text{ A pulsed}$

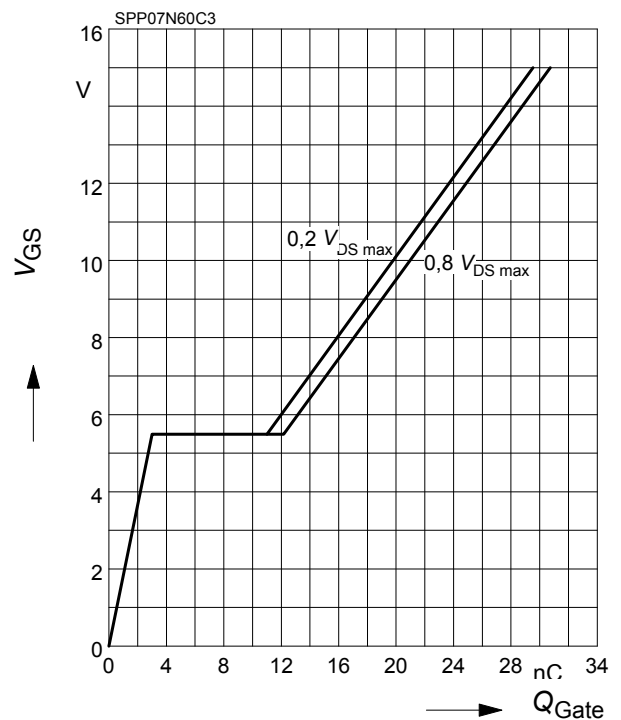

**13 Forward characteristics of body diode**

$I_F = f(V_{SD})$

parameter:  $T_j$ ,  $t_p = 10 \mu s$

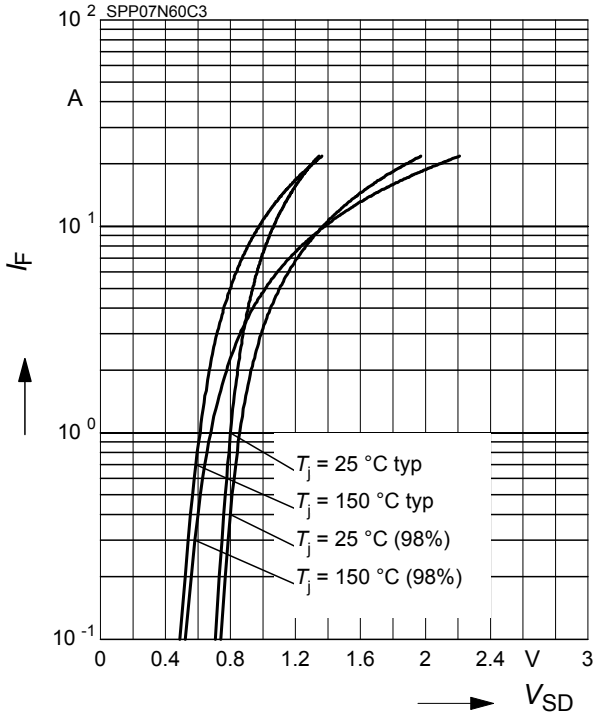

**14 Typ. switching time**

$t = f(I_D)$ , inductive load,  $T_j = 125^\circ C$

par.:  $V_{DS} = 380V$ ,  $V_{GS} = 0/+13V$ ,  $R_G = 12\Omega$

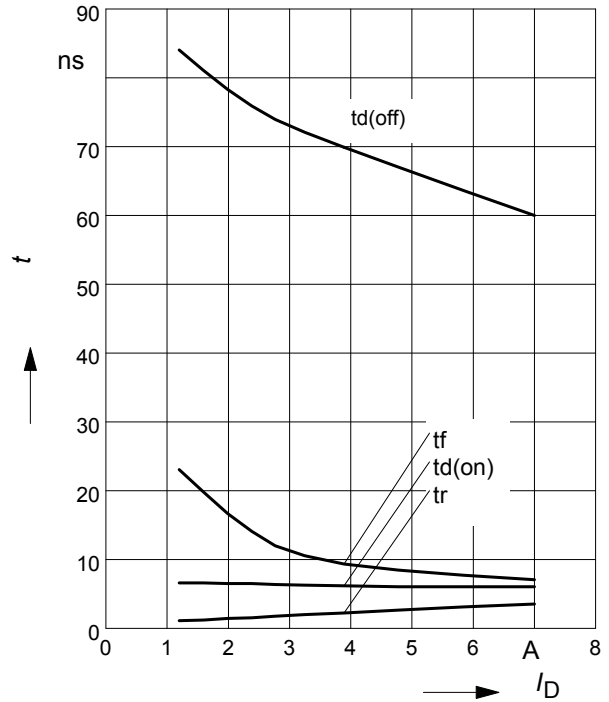

**15 Typ. switching time**

$t = f(R_G)$ , inductive load,  $T_j = 125^\circ C$

par.:  $V_{DS} = 380V$ ,  $V_{GS} = 0/+13V$ ,  $I_D = 7.3 A$

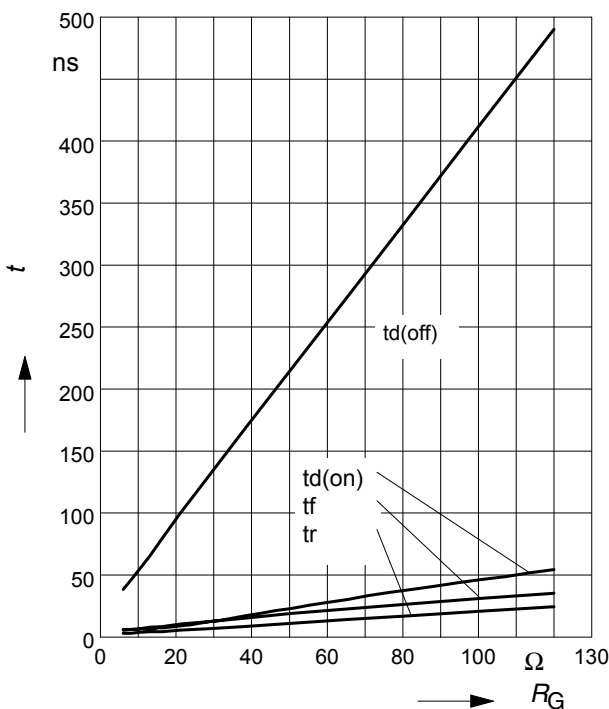

**16 Typ. drain current slope**

$di/dt = f(R_G)$ , inductive load,  $T_j = 125^\circ C$

par.:  $V_{DS} = 380V$ ,  $V_{GS} = 0/+13V$ ,  $I_D = 7.3A$

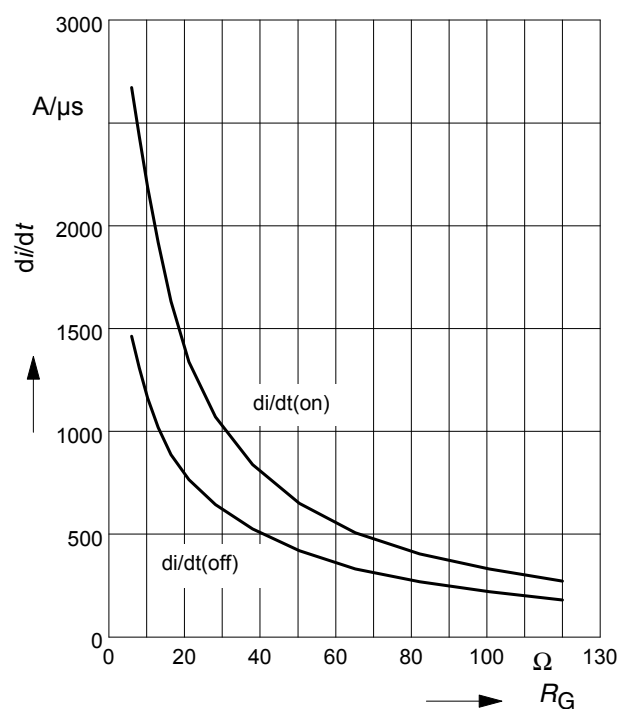



**17 Typ. drain source voltage slope**

$dv/dt = f(R_G)$ , inductive load,  $T_j = 125^\circ\text{C}$   
 par.:  $V_{DS}=380\text{V}$ ,  $V_{GS}=0/+13\text{V}$ ,  $I_D=7.3\text{A}$

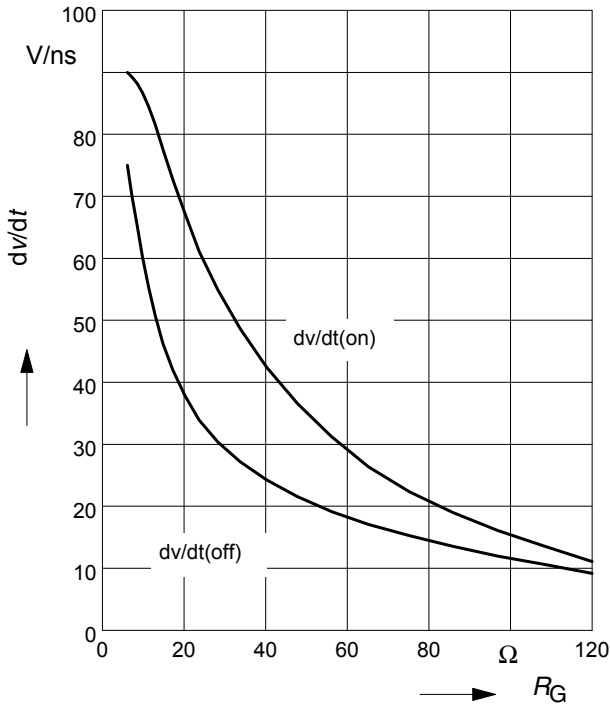

**18 Typ. switching losses**

$E = f(I_D)$ , inductive load,  $T_j=125^\circ\text{C}$   
 par.:  $V_{DS}=380\text{V}$ ,  $V_{GS}=0/+13\text{V}$ ,  $R_G=12\Omega$

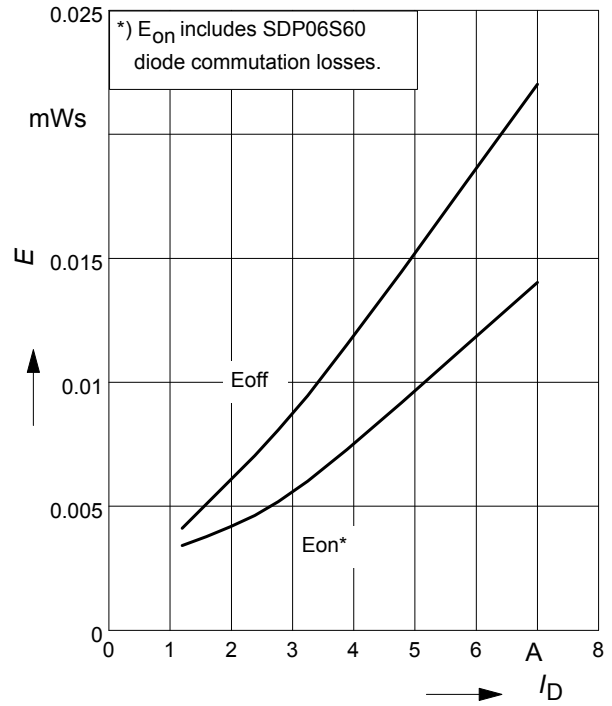

**19 Typ. switching losses**

$E = f(R_G)$ , inductive load,  $T_j=125^\circ\text{C}$   
 par.:  $V_{DS}=380\text{V}$ ,  $V_{GS}=0/+13\text{V}$ ,  $I_D=7.3\text{A}$

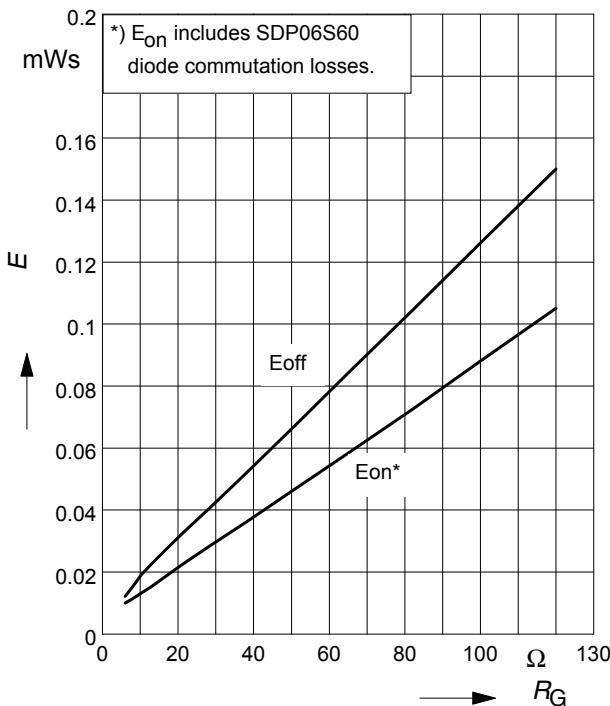

**20 Avalanche SOA**

$I_{AR} = f(t_{AR})$   
 par.:  $T_j \leq 150^\circ\text{C}$

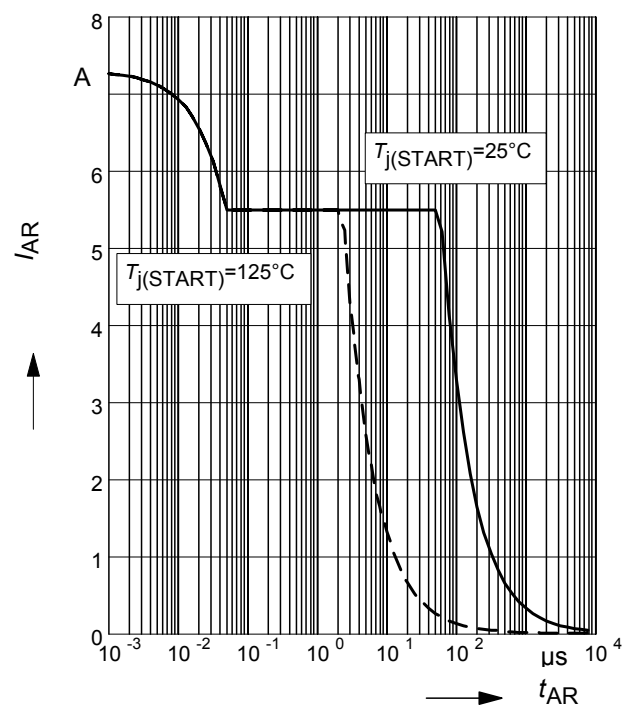

**21 Avalanche energy**

$$E_{AS} = f(T_j)$$

par.:  $I_D = 5.5 \text{ A}$ ,  $V_{DD} = 50 \text{ V}$

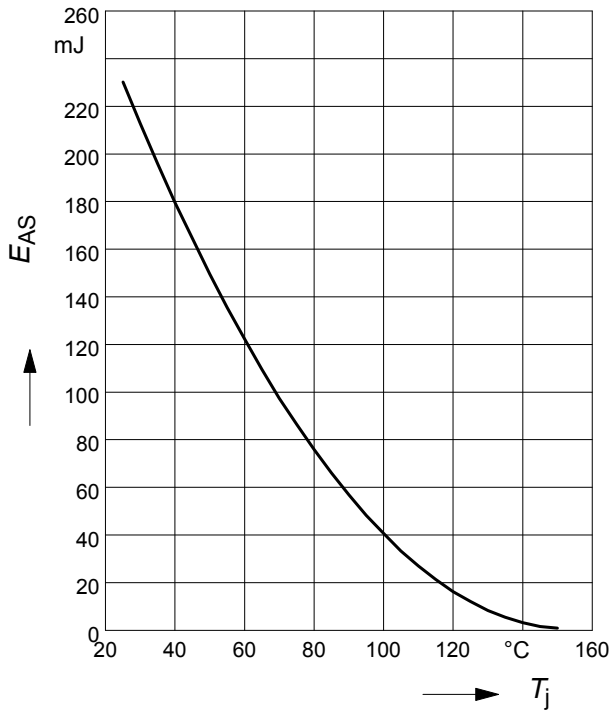

**22 Drain-source breakdown voltage**

$$V_{(BR)DSS} = f(T_j)$$

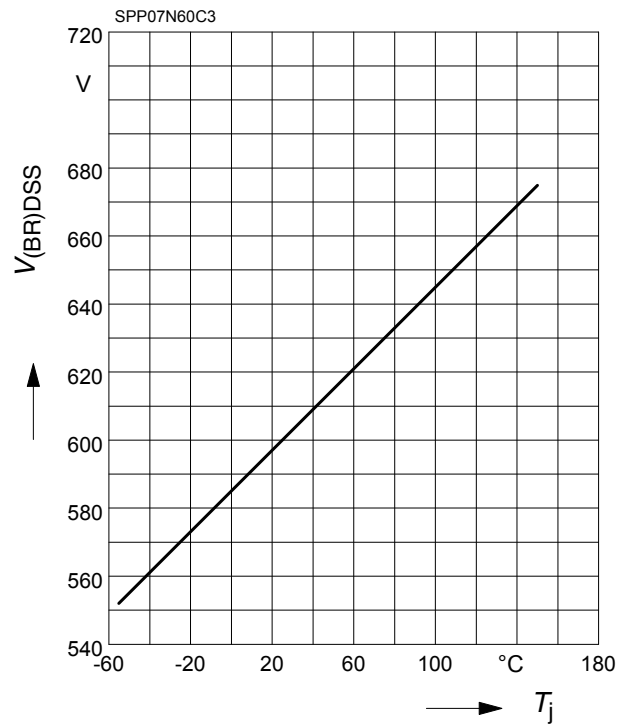

**23 Avalanche power losses**

$$P_{AR} = f(f)$$

parameter:  $E_{AR} = 0.5 \text{ mJ}$

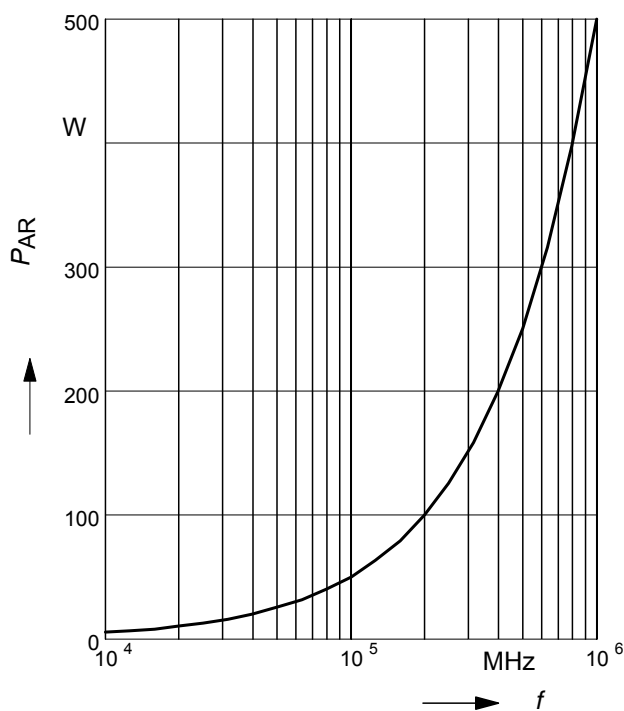

**24 Typ. capacitances**

$$C = f(V_{DS})$$

parameter:  $V_{GS} = 0 \text{ V}$ ,  $f = 1 \text{ MHz}$

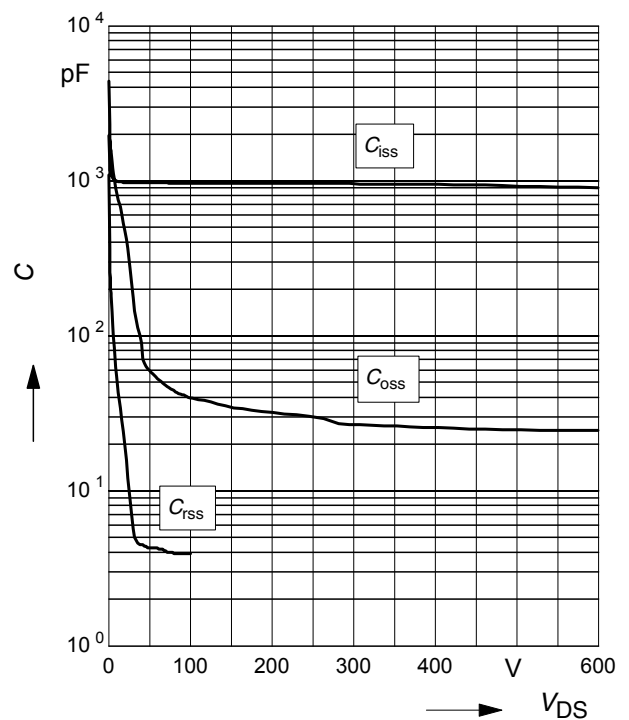

25 Typ.  $C_{OSS}$  stored energy

$$E_{OSS} = f(V_{DS})$$

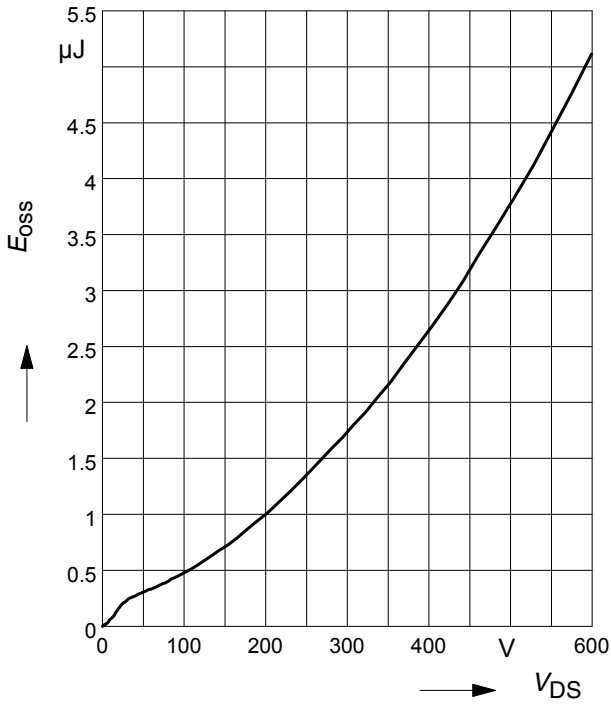

Definition of diodes switching characteristics

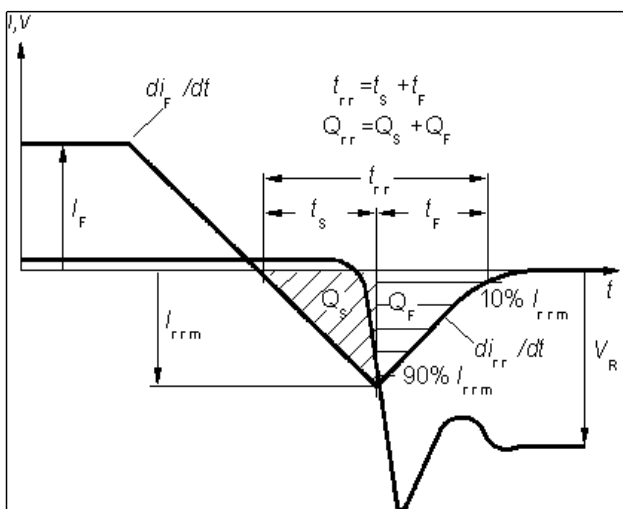

PG-TO263-3-2/ PG-TO263-3-5/ PG-TO263-3-22

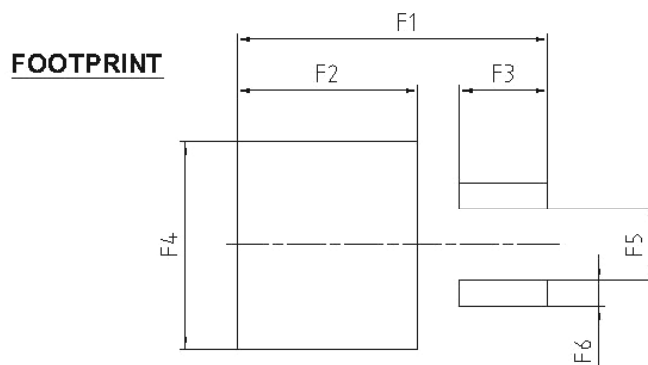
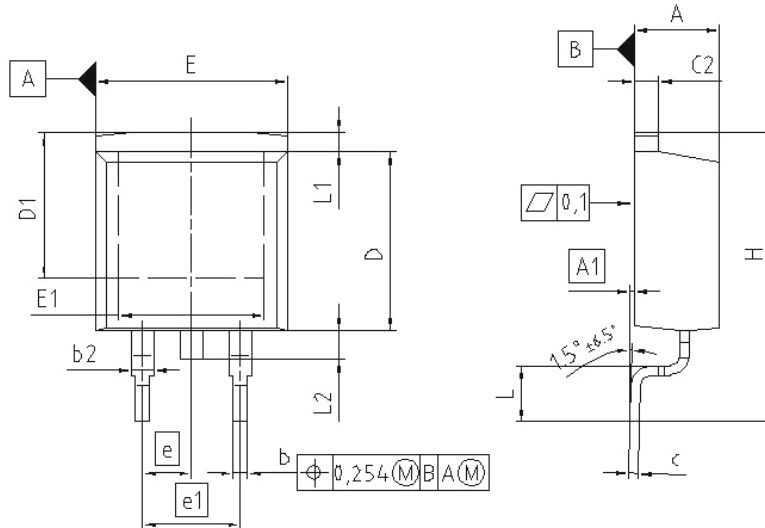

DIM	MILLIMETERS		INCHES	
	MIN	MAX	MIN	MAX
A	4.300	4.572	0.169	0.180
A1	0.000	0.254	0.000	0.010
b	0.650	0.850	0.026	0.033
b2	0.950	1.321	0.037	0.052
c	0.330	0.650	0.013	0.026
c2	0.170	1.400	0.046	0.055
D	8.509	9.450	0.335	0.372
D1	7.100	-	0.280	-
E	9.800	10.312	0.386	0.406
E1	6.500	-	0.256	-
e	2.540		0.100	
e1	5.080		0.200	
N	2		2	
H	14.605	15.875	0.575	0.625
L	2.200	3.000	0.087	0.118
L1	-	1.600	-	0.063
L2	1.000	1.778	0.039	0.070
F1	16.050	16.250	0.632	0.640
F2	9.300	9.500	0.366	0.374
F3	4.500	4.700	0.177	0.185
F4	10.700	10.900	0.421	0.429
F5	3.630	3.830	0.143	0.151
F6	1.100	1.300	0.043	0.051

**REFERENCE**  
JEDEC TO263

**SCALE**  
0 5 5  
7.5mm

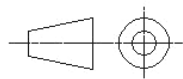
**EUROPEAN PROJECTION**  

**ISSUE DATE**  
12-02-2006

**FILE**  
TO263\_2

**Published by**  
**Infineon Technologies AG**  
**81726 München**  
**Germany**

**© Infineon Technologies AG 2006**  
**All Rights Reserved.**

**Attention please!**

The information herein is given to describe certain components and shall not be considered as warranted characteristics.

Terms of delivery and rights to technical change reserved.

We hereby disclaim any and all warranties, including but not limited to warranties of non-infringement, regarding circuits, descriptions and charts stated herein.

Infineon Technologies is an approved CECC manufacturer.

**Information**

For further information on technology, delivery terms and conditions and prices please contact your nearest Infineon Technologies Office in Germany or our Infineon Technologies Representatives worldwide (see address list).

**Warnings**

Due to technical requirements components may contain dangerous substances.

For information on the types in question please contact your nearest Infineon Technologies Office.

Infineon Technologies Components may only be used in life-support devices or systems with the express written approval of Infineon Technologies, if a failure of such components can reasonably be expected to cause the failure of that life-support device or system, or to affect the safety or effectiveness of that device or system. Life support devices or systems are intended to be implanted in the human body, or to support and/or maintain and sustain and/or protect human life. If they fail, it is reasonable to assume that the health of the user or other persons may be endangered.