

NOTES:

1. MATERIALS AND FINISHES:

RP SMA STR BHD JACK - BRASS, GOLD PLATING
 CABLE - 1.32 MM TO AMC R/A PLUG

2. ELECTRICAL:

A. IMPEDANCE: 50 OHM, NOMINAL

3. PACKAGING:

A. QUANTITY: SINGLE PACK
 B. BAG TO BE MARKED: AMPHENOL RF, 336314-13-XXXX, AND DATE CODE

THIRD ANGLE PROJ.

REVISIONS

REV	DESCRIPTION	DATE	ECO	APPR
A	RELEASE TO MFG	--	--	--
B	DRAWING UPDATED & COD SHEET ADDED	28-Jul-15	50567	NR

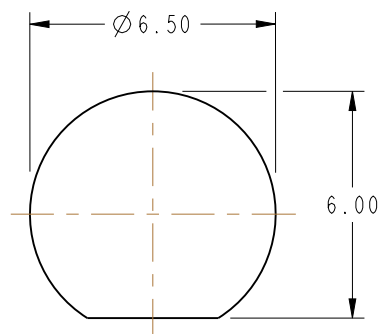

RECOMMENDED MOUNTING HOLE DIMENSIONS

(MAX. PANEL THICKNESS = 3.20 MM)

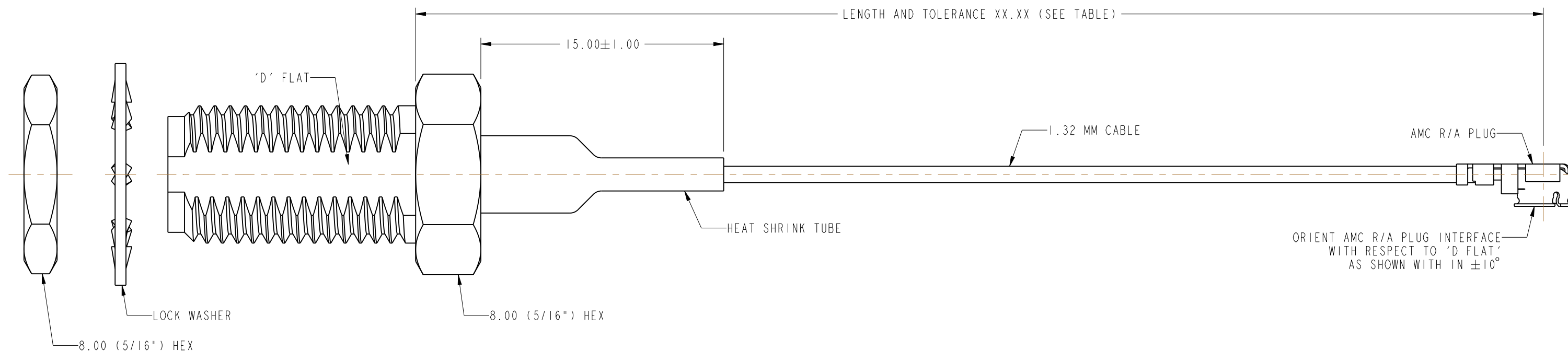
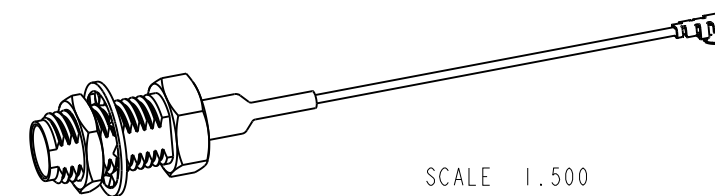

PART NUMBER	LENGTH AND TOLERANCE XX.XX IN MM
336314-13-0050	50.00±5.00
336314-13-0100	100.00±5.00
336314-13-0150	150.00±5.00
336314-13-0200	200.00±5.00
336314-13-0250	250.00±5.00
336314-13-0300	300.00±5.00

DESIGN REQUIREMENTS:

- | | |
|---|---|
| <input checked="" type="checkbox"/> FREQUENCY : DC TO 6 GHz | <input checked="" type="checkbox"/> CONTINUITY |
| <input type="checkbox"/> VSWR : ---- MAX | <input checked="" type="checkbox"/> HI-POT : 200 VRMS |
| <input type="checkbox"/> INS. LOSS : ---- dBMAX | <input type="checkbox"/> OTHER |

CUSTOMER OUTLINE DRAWING

ALL OTHER SHEETS ARE FOR INTERNAL USE ONLY

UNLESS OTHERWISE SPECIFIED, DIMENSIONS ARE IN METRIC AND TOLERANCES ARE:
 <0.5mm ±0.05mm 0.5 - 6mm ±0.1mm 6 - 30mm ±0.2mm 30 - 120mm ±0.3mm ANGLES ±1°

NOTICE - These drawings, specifications, or other data (1) are, and remain the property of Amphenol corp. (2) must be returned upon request; and (3) are confidential and not to be disclosed to any person other than those to whom they are given by Amphenol Corp. the furnishing of these drawings, specifications, or other data by Amphenol Corp., or to any other person to anyone for any purpose is not to be regarded by implication or otherwise in any manner licensing, granting rights to permitting such holder or any other person to manufacture, use or sell any product, process or design, patented or otherwise, that may in any way be related to or disclosed by said drawings, specifications, or other data.

MATERIAL SEE NOTES	DRAWN RAJAGOPAL N	DATE 19-May-15	TITLE RP SMA STR BHD JACK TO AMC R/A PLUG USING 1.32 MM CABLE VARIOUS LENGTH		Amphenol RF www.amphenolrf.com
REFERENCE EAR # 6751	ENGINEER RAJAGOPAL N	DATE 19-May-15	DRAWING NO. 336314-13-XXXX		
CONFIGURATION LEVEL: In Work	APPROVED K.CAPOZZI	DATE 28-Jul-15	SCALE: 5.5:1.0	SHEET 2 OF 2	ITEM NO. 336314-13-XXXX
FINISH	CAD FILE	DWG SIZE B	REV B	PART NO. 336314-13-XXXX	