

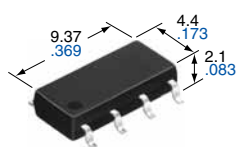

**Miniature SOP4, 8-pin type
of 60 V/350 V/400 V
load voltage**

**PhotoMOS®
GU SOP 1, 2 Form A
(AQY, W280S)**

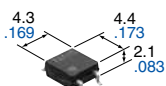

mm inch

FEATURES

- 1. Low cost type.**
- 2. High sensitivity, Low ON resistance**
Can control a maximum 0.5A (AQY282S, AQW282S) load current with a 5mA input current.
Low ON resistance of 2.5Ω (AQY282S, AQW282S).
Stable operation because there are no metallic contact parts.
- 3. Various package design (DIP4, SOP4, DIP8, SOP8 packages are available)**
- 4. Low-level off state leakage current**
The SSR has an off state leakage current of several milliamperes, where as the PhotoMOS relay has only 100pA even with the rated load voltage of 350V (AQY280S, AQW280S).

TYPICAL APPLICATIONS

- Modem
- Telephone equipment
- Security equipment
- Sensors
- Amusement

TYPES

SOP 4pin

Type	Output rating*		Part No.		Packing quantity in tape and reel
	Load voltage	Load current	Picked from the 1/2-pin side	Picked from the 3/4-pin side	
AC/DC type	60 V	500 mA	AQY282SX	AQY282SZ	1,000 pcs.
	350 V	120 mA	AQY280SX	AQY280SZ	
	400 V	100 mA	AQY284SX	AQY284SZ	

*Indicate the peak AC and DC values.

Notes: 1. Tape package is the standard packing style. Also available in tube. (Part No. suffix "X" or "Z" is not needed when ordering; Tube: 100 pcs.; Case: 2,000 pcs.)
2. For space reasons, the initial letters of the product number "AQY" and "S", the package type indicator "X" and "Z" are omitted from the seal.

SOP 8pin

Type	Output rating*		Part No.		Packing quantity in tape and reel
	Load voltage	Load current	Picked from the 1/2/3/4-pin side	Picked from the 5/6/7/8-pin side	
AC/DC type	60 V	350 mA	AQW282SX	AQW282SZ	1,000 pcs.
	350 V	100 mA	AQW280SX	AQW280SZ	
	400 V	80 mA	AQW284SX	AQW284SZ	

* Indicate the peak AC and DC values.

Notes: 1. Tape package is the standard style. Also available in tube. (Part No. suffix "X" or "Z" is not needed when ordering; Tube: 50 pcs.; Case: 1,000 pcs.)
2. For space reasons, the package type indicator "X" and "Z" are omitted from the seal.

RATING

1. Absolute maximum ratings (Ambient temperature: 25°C 77°F)

SOP 4pin

Item		Symbol	AQY282S	AQY280S	AQY284S	Remarks
Input	LED forward current	I_F	50 mA			
	LED reverse voltage	V_R	5 V			
	Peak forward current	I_{FP}	1 A			f = 100 Hz, Duty factor = 0.1%
	Power dissipation	P_{in}	75 mW			
Output	Load voltage (peak AC)	V_L	60 V	350 V	400 V	
	Continuous load current (peak AC)	I_L	0.5 A	0.12 A	0.1 A	
	Peak load current	I_{peak}	1.5 A	0.3 A	0.24 A	100 ms (1 shot), $V_L = DC$
	Power dissipation	P_{out}	300 mW			
Total power dissipation		P_T	350 mW			
I/O isolation voltage		V_{iso}	1,500 V AC			
Operating temperature		T_{opr}	-40°C to +85°C -40°F to +185°F			Non-condensing at low temperature
Storage temperature		T_{stg}	-40°C to +100°C -40°F to +212°F			

SOP 8pin

Item		Symbol	AQW282S	AQW280S	AQW284S	Remarks
Input	LED forward current	I_F	50 mA			
	LED reverse voltage	V_R	5 V			
	Peak forward current	I_{FP}	1 A			f = 100 Hz, Duty factor = 0.1%
	Power dissipation	P_{in}	75 mW			
Output	Load voltage (peak AC)	V_L	60 V	350 V	400 V	
	Continuous load current (peak AC)	I_L	0.35 (0.5) A	0.1 (0.13) A	0.08 (0.1) A	(): in case of using only 1 channel
	Peak load current	I_{peak}	1.05 A	0.3 A	0.24 A	100 ms (1 shot), $V_L = DC$
	Power dissipation	P_{out}	600 mW			
Total power dissipation		P_T	650 mW			
I/O isolation voltage		V_{iso}	1,500 V AC			
Operating temperature		T_{opr}	-40°C to +85°C -40°F to +185°F			Non-condensing at low temperature
Storage temperature		T_{stg}	-40°C to +100°C -40°F to +212°F			

2. Electrical characteristics (Ambient temperature: 25°C 77°F)

SOP 4pin

Item		Symbol	AQY282S	AQY280S	AQY284S	Condition
Input	LED operate current	Typical	1.8 mA			$I_L = \text{Max.}$
		Maximum	3.0 mA			
	LED turn off current	Minimum	0.2 mA			$I_L = \text{Max.}$
		Typical	1.6 mA			
LED dropout voltage	Typical	1.14 V (1.25 V at $I_F = 50\text{mA}$)			$I_F = 5 \text{ mA}$	
	Maximum	1.5 V				
Output	On resistance	Typical	0.85Ω	20Ω	28Ω	$I_F = 5 \text{ mA}$ $I_L = \text{Max.}$ Within 1 s on time
		Maximum	2.5Ω	25Ω	35Ω	
	Off state leakage current	Maximum	1μA			$I_F = 0 \text{ mA}$ $V_L = \text{Max.}$
Transfer characteristics	Turn on time*	Typical	0.9 ms	0.3 ms		$I_F = 5 \text{ mA}$ $I_L = \text{Max.}$
		Maximum	3 ms			
	Turn off time*	Typical	0.5 ms			$I_F = 5 \text{ mA}$ $I_L = \text{Max.}$
		Maximum	2 ms			
	I/O capacitance	Typical	0.8 pF			f = 1 MHz $V_B = 0\text{V}$
Maximum		1.5 pF				
Initial I/O isolation resistance	Minimum	R_{iso}	1,000 MΩ		500 V DC	

SOP 8pin

Item			Symbol	AQW282S	AQW280S	AQW284S	Condition
Input	LED operate current	Typical	I _{Fon}	1.8 mA			I _L = Max.
		Maximum		3.0 mA			
	LED turn off current	Minimum	I _{Foff}	0.2 mA			I _L = Max.
		Typical		1.6 mA			
	LED dropout voltage	Typical	V _F	1.14 V (1.25 V at I _F = 50mA)			I _F = 5 mA
		Maximum		1.5 V			
Output	On resistance	Typical	R _{on}	0.85Ω	20Ω	28Ω	I _F = 5 mA I _L = Max. Within 1 s on time
		Maximum		2.5Ω	25Ω	35Ω	
	Off state leakage current	Maximum	I _{Leak}	1μA			I _F = 0 mA V _L = Max.
Transfer characteristics	Turn on time*	Typical	T _{on}	0.9 ms	0.3 ms		I _F = 5 mA I _L = Max.
		Maximum		3 ms			
	Turn off time*	Typical	T _{off}	0.5 ms			I _F = 5 mA I _L = Max.
		Maximum		2 ms			
	I/O capacitance	Typical	C _{iso}	0.8 pF			f = 1 MHz V _b = 0V
		Maximum		1.5 pF			
Initial I/O isolation resistance	Minimum	R _{iso}	1,000 MΩ			500 V DC	

*Turn on/Turn off time

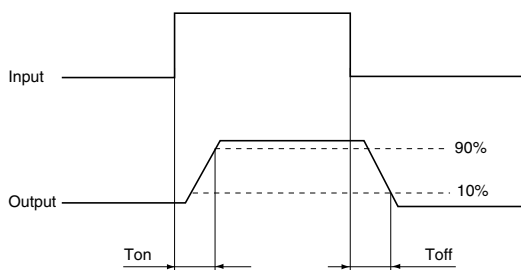

3-4 the terminal leads receive solder plating or solder dip plating.

RECOMMENDED OPERATING CONDITIONS

Please obey the following conditions to ensure proper device operation and resetting.

Item	Symbol	Recommended value	Unit
Input LED current	I _F	5	mA

REFERENCE DATA

1. Load current vs. ambient temperature characteristics

Allowable ambient temperature: -40°C to +85°C
-40°F to +185°F

Type of connection: A

(1) AQY282S

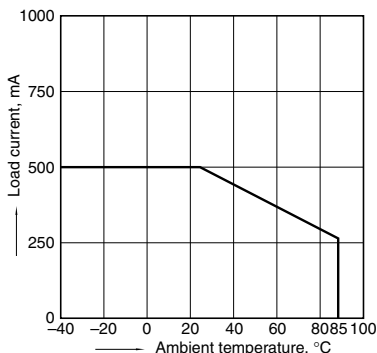

(2) AQY280S, AQY284S

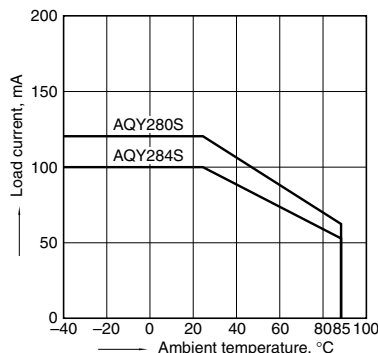

(3) AQW282S

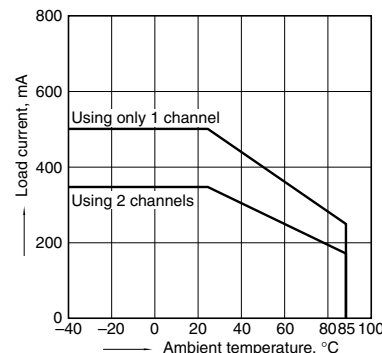

(4) AQW280S, AQW284S

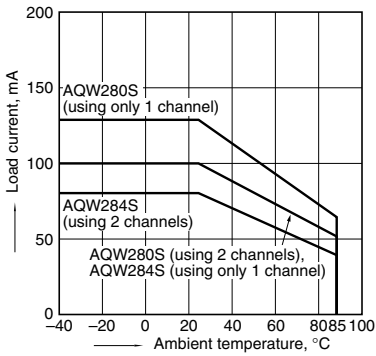

2.-(1) On resistance vs. ambient temperature characteristics

Measured portion: between terminals 3 and 4 (Y type), 5 and 6, 7 and 8 (W type);
LED current: 5 mA; Load voltage: Max. (DC);
Continuous load current: Max. (DC)

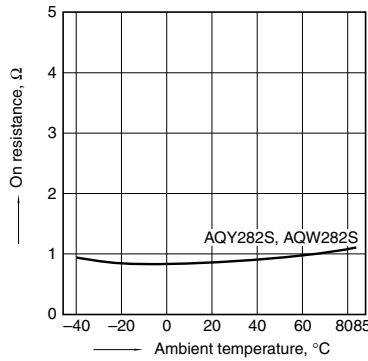

2.-(2) On resistance vs. ambient temperature characteristics

Measured portion: between terminals 3 and 4 (Y type), 5 and 6, 7 and 8 (W type);
LED current: 5 mA; Load voltage: Max. (DC);
Continuous load current: Max. (DC)

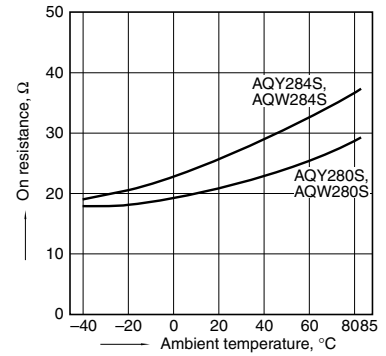

3. Turn on time vs. ambient temperature characteristics

Measured portion: between terminals 3 and 4 (Y type), 5 and 6, 7 and 8 (W type);
LED current: 5 mA; Load voltage: Max. (DC);
Continuous load current: Max. (DC)

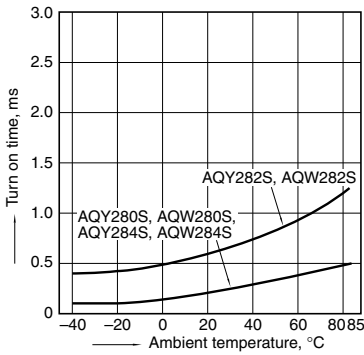

4. Turn off time vs. ambient temperature characteristics

Measured portion: between terminals 3 and 4 (Y type), 5 and 6, 7 and 8 (W type);
LED current: 5 mA; Load voltage: Max. (DC);
Continuous load current: Max. (DC)

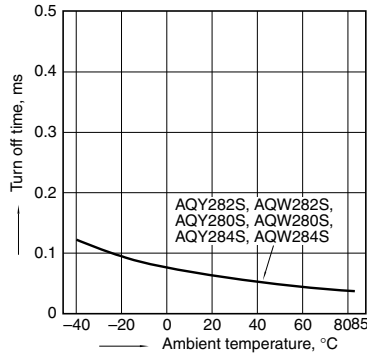

5. LED operate current vs. ambient temperature characteristics

Sample: All types; Load voltage: Max. (DC);
Continuous load current: Max. (DC)

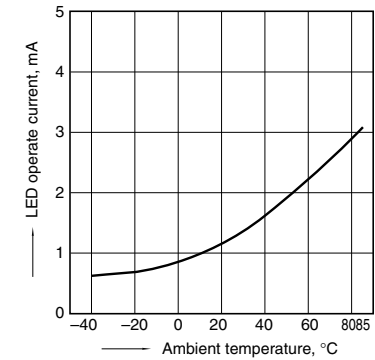

6. LED turn off current vs. ambient temperature characteristics

Sample: All types; Load voltage: Max. (DC);
Continuous load current: Max. (DC)

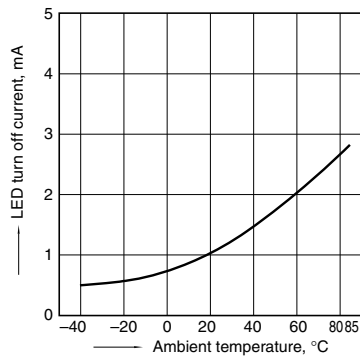

7. LED dropout voltage vs. ambient temperature characteristics

Sample: All types;
LED current: 5 to 50 mA

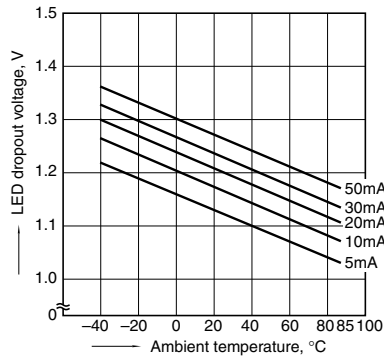

8.-(1) Current vs. voltage characteristics of output at MOS portion

Measured portion: between terminals 3 and 4 (Y type), 5 and 6, 7 and 8 (W type);
Ambient temperature: 25°C 77°F

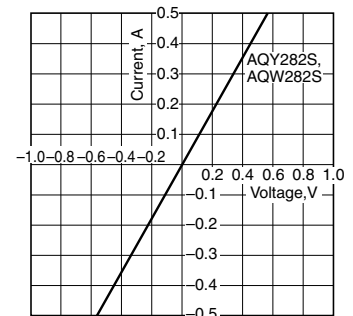

8.-(2) Current vs. voltage characteristics of output at MOS portion

Measured portion: between terminals 3 and 4 (Y type), 5 and 6, 7 and 8 (W type);
Ambient temperature: 25°C 77°F

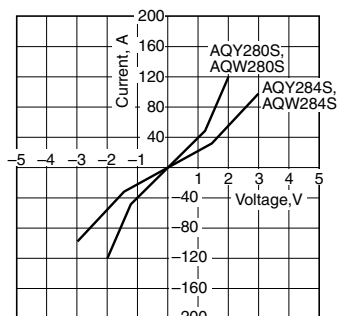

9. Off state leakage current vs. load voltage

Measured portion: between terminals 3 and 4 (Y type), 5 and 6, 7 and 8 (W type);
Sample: All types;
Ambient temperature: 25°C 77°F

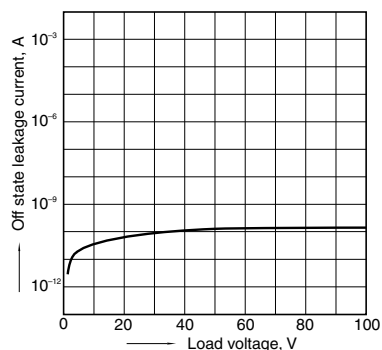

10. Turn on time vs. LED forward current characteristics

Measured portion: between terminals 3 and 4 (Y type), 5 and 6, 7 and 8 (W type);
Load voltage: Max. (DC); Continuous load current: Max. (DC); Ambient temperature: 25°C 77°F

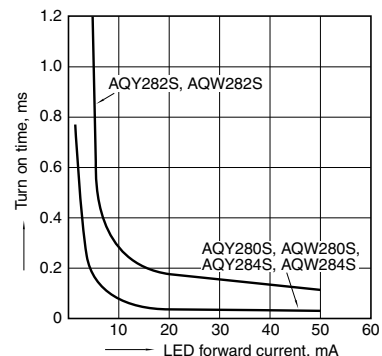

11. Turn off time vs. LED forward current characteristics

Measured portion: between terminals 3 and 4 (Y type), 5 and 6, 7 and 8 (W type);
Load voltage: Max. (DC); Continuous load current: Max. (DC); Ambient temperature: 25°C 77°F

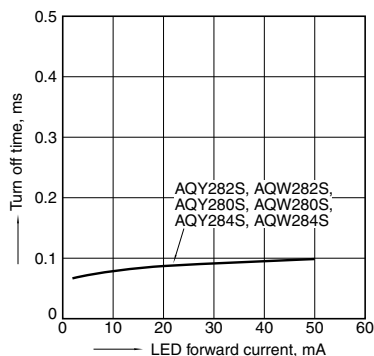

12. Output capacitance vs. applied voltage characteristics

Measured portion: between terminals 3 and 4 (Y type), 5 and 6, 7 and 8 (W type);
Frequency: 1 MHz;
Ambient temperature: 25°C 77°F

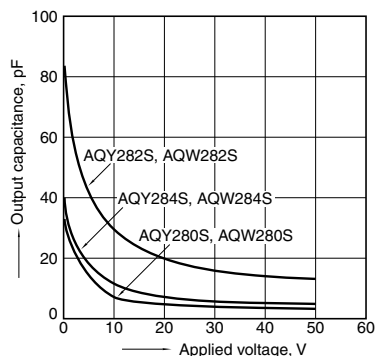



DIP4, 6-pin type, reinforced insulation available

**PhotoMOS[®]
GE 1, 2 Form A
(AQY, W280EH)**

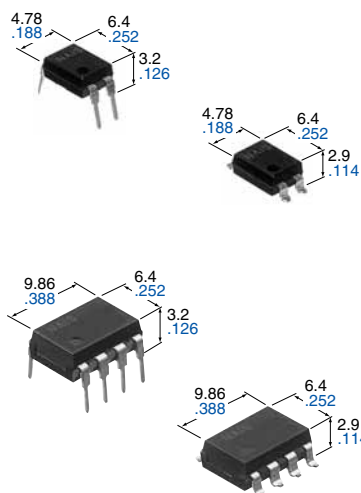

mm inch

FEATURES

- 1. Low cost type.**
- 2. Reinforced insulation 5,000V type (DIP type)**
More than 0.4mm internal insulation distance between inputs and outputs. Conforms to EN41003, EN60950 (reinforced insulation)
- 3. Various package design (DIP4, SOP4, DIP8, SOP8 packages are available)**
- 4. High sensitivity, Low ON resistance**
Can control a maximum 0.5A (AQY282EH, AQW282EH) load current with a 5mA input current. Low ON resistance of 2.5Ω (AQY282EH, AQW282EH). Stable operation because there are no metallic contact parts.
- 5. Low-level off state leakage current**
The SSR has an off state leakage current of several milliamperes, where as the PhotoMOS relay has only 100pA even with the rated load voltage of 350V (AQY280EH).

TYPICAL APPLICATIONS

- Modem
- Telephone equipment
- Security equipment
- Sensors
- Amusement

TYPES

DIP 4pin

Type	I/O isolation voltage	Output rating*		Part No.				Packing quantity
				Through hole terminal	Surface-mount terminal			
		Load voltage	Load current		Tube packing style		Tape and reel packing style	
				Picked from the 1/2-pin side	Picked from the 3/4-pin side			
AC/DC type	Reinforced 5,000 V	60 V	500 mA	AQY282EH	AQY282EHA	AQY282EHAX	AQY282EHAZ	Tube: 1 tube contains 100 pcs. Tube: 1 batch contains 1,000 pcs. Tape and reel: 1,000 pcs.
		350 V	130 mA	AQY280EH	AQY280EHA	AQY280EHAX	AQY280EHAZ	
		400 V	120 mA	AQY284EH	AQY284EHA	AQY284EHAX	AQY284EHAZ	

*Indicate the peak AC and DC values.

Note: For space reasons, the initial letters of the product number "AQY", the SMD terminal shape indicator "A" and the package type indicator "X" and "Z" are omitted from the seal.

DIP 8pin

Type	I/O isolation voltage	Output rating*		Part No.				Packing quantity
				Through hole terminal	Surface-mount terminal			
		Load voltage	Load current		Tube packing style		Tape and reel packing style	
				Picked from the 1/2/3/4-pin side	Picked from the 5/6/7/8-pin side			
AC/DC type	Reinforced 5,000 V	60 V	400 mA	AQW282EH	AQW282EHA	AQW282EHAX	AQW282EHAZ	Tube: 1 tube contains 50 pcs. Tube: 1 batch contains 500 pcs. Tape and reel: 1,000 pcs.
		350 V	120 mA	AQW280EH	AQW280EHA	AQW280EHAX	AQW280EHAZ	
		400 V	100 mA	AQW284EH	AQW284EHA	AQW284EHAX	AQW284EHAZ	

*Indicate the peak AC and DC values.

Note: For space reasons, the SMD terminal shape indicator "A" and the package type indicator "X" and "Z" are omitted from the seal.

RATING

1. Absolute maximum ratings (Ambient temperature: 25°C 77°F)

DIP 4pin

Item		Symbol	AQY282EH	AQY280EH	AQY284EH	Remarks
Input	LED forward current	I_F	50 mA			
	LED reverse voltage	V_R	5 V			
	Peak forward current	I_{FP}	1 A			f = 100 Hz, Duty factor = 0.1%
	Power dissipation	P_{in}	75 mW			
Output	Load voltage (peak AC)	V_L	60 V	350 V	400 V	
	Continuous load current (peak AC)	I_L	0.5 A	0.13 A	0.12 A	
	Peak load current	I_{peak}	1.5 A	0.4 A	0.3 A	100 ms (1 shot), $V_L = DC$
	Power dissipation	P_{out}	500 mW			
Total power dissipation		P_T	550 mW			
I/O isolation voltage		V_{iso}	5,000 V AC			
Operating temperature		T_{opr}	-40°C to +85°C -40°F to +185°F			Non-condensing at low temperature
Storage temperature		T_{stg}	-40°C to +100°C -40°F to +212°F			

DIP 8pin

Item		Symbol	AQW282E	AQW280EH	AQW284EH	Remarks
Input	LED forward current	I_F	50 mA			
	LED reverse voltage	V_R	5 V			
	Peak forward current	I_{FP}	1 A			f = 100 Hz, Duty factor = 0.1%
	Power dissipation	P_{in}	75 mW			
Output	Load voltage (peak AC)	V_L	60 V	350 V	400 V	
	Continuous load current (peak AC)	I_L	0.4 (0.5) A	0.12 (0.14) A	0.1 (0.13) A	(): in case of using only 1 channel
	Peak load current	I_{peak}	1.2 A	0.36 A	0.3 A	100 ms (1 shot), $V_L = DC$
	Power dissipation	P_{out}	800 mW			
Total power dissipation		P_T	850 mW			
I/O isolation voltage		V_{iso}	5,000 V AC			
Operating temperature		T_{opr}	-40°C to +85°C -40°F to +185°F			Non-condensing at low temperature
Storage temperature		T_{stg}	-40°C to +100°C -40°F to +212°F			

2. Electrical characteristics (Ambient temperature: 25°C 77°F)

DIP4pin

Item		Symbol	AQY282EH	AQY280EH	AQY284EH	Condition
Input	LED operate current	Typical	1.8 mA			$I_L = Max.$
		Maximum	3.0 mA			
	LED turn off current	Minimum	0.2 mA			$I_L = Max.$
		Typical	1.6 mA			
LED dropout voltage	Typical	1.14 V (1.25 V at $I_F = 50mA$)			$I_F = 5 mA$	
	Maximum	1.5 V				
Output	On resistance	Typical	0.85Ω	20Ω	28Ω	$I_F = 5 mA$ $I_L = Max.$ Within 1 s on time
		Maximum	2.5Ω	25Ω	35Ω	
	Off state leakage current	Maximum	1μA			$I_F = 0 mA$ $V_L = Max.$
Transfer characteristics	Turn on time*	Typical	1.8 ms	1.5 ms		$I_F = 5 mA$ $I_L = Max.$
		Maximum	5 ms			
	Turn off time*	Typical	0.5 ms			$I_F = 5 mA$ $I_L = Max.$
		Maximum	2 ms			
	I/O capacitance	Typical	0.8 pF			f = 1 MHz $V_B = 0V$
Maximum		1.5 pF				
Initial I/O isolation resistance	Minimum	R_{iso}	1,000 MΩ		500 V DC	

GE 1, 2 Form A (AQY, W280EH)

DIP8pin

Ite			Symbol	AQW282EH	AQW280EH	AQW284EH	Condition
Input	LED operate current	Typical	I _{Fon}	1.8 mA			I _L = Max.
		Maximum		3.0 mA			
	LED turn off current	Minimum	I _{Foff}	0.2 mA			I _L = Max.
		Typical		1.6 mA			
LED dropout voltage	Typical	V _F	1.14 V (1.25 V at I _F = 50mA)			I _F = 5 mA	
	Maximum		1.5 V				
Output	On resistance	Typical	R _{on}	0.85Ω	20Ω	28Ω	I _F = 5 mA I _L = Max. Within 1 s on time
		Maximum		2.5Ω	25Ω	35Ω	
	Off state leakage current	Maximum	I _{LLeak}	1μA			I _F = 0 mA V _L = Max.
Transfer characteristics	Turn on time*	Typical	T _{on}	1.8 ms	1.5 ms		I _F = 5 mA I _L = Max.
		Maximum		5 ms			
	Turn off time*	Typical	T _{off}	0.5 ms			I _F = 5 mA I _L = Max.
		Maximum		2 ms			
	I/O capacitance	Typical	C _{iso}	0.8 pF			f = 1 MHz V _B = 0V
Maximum		1.5 pF					
Initial I/O isolation resistance	Minimum	R _{iso}	1,000 MΩ			500 V DC	

*Turn on/Turn off time

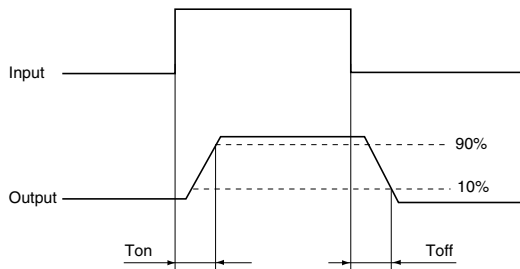

3-4 the terminal leads receive solder plating or solder dip plating.

RECOMMENDED OPERATING CONDITIONS

Please obey the following conditions to ensure proper device operation and resetting.

Item	Symbol	Recommended value	Unit
Input LED current	I _F	5 to 10	mA

REFERENCE DATA

1. Load current vs. ambient temperature characteristics

Allowable ambient temperature: -40°C to +85°C
-40°F to +185°F

Type of connection: A

(1) AQY282EH

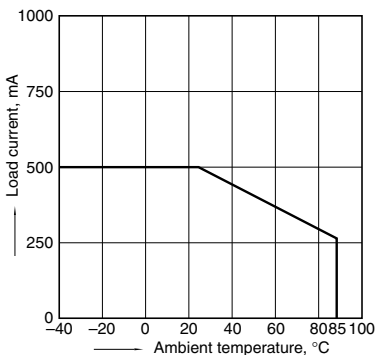

(2) AQY280EH, AQY284EH

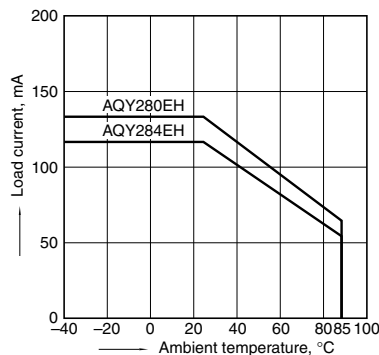

(3) AQW282EH

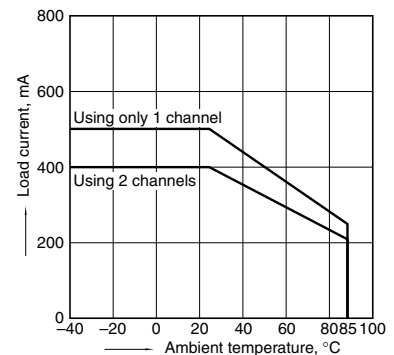

(4) AQW280EH, AQW284EH

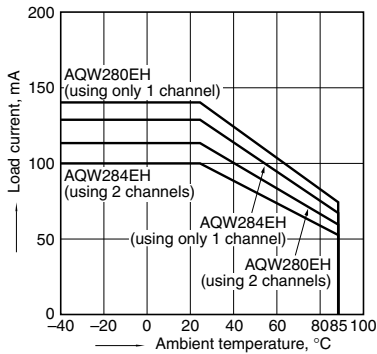

2.-(1) On resistance vs. ambient temperature characteristics

Measured portion: between terminals 3 and 4 (Y type), 5 and 6, 7 and 8 (W type);
LED current: 5 mA; Load voltage: Max. (DC);
Continuous load current: Max. (DC)

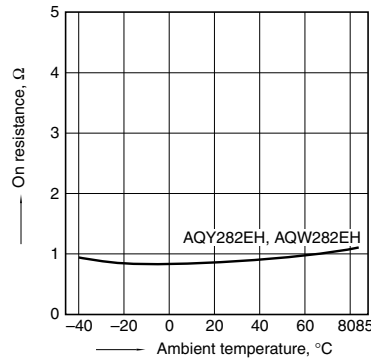

2.-(2) On resistance vs. ambient temperature characteristics

Measured portion: between terminals 3 and 4 (Y type), 5 and 6, 7 and 8 (W type);
LED current: 5 mA; Load voltage: Max. (DC);
Continuous load current: Max. (DC)

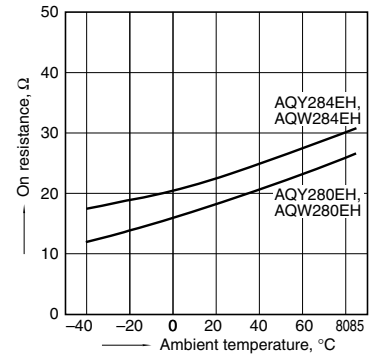

3. Turn on time vs. ambient temperature characteristics

Measured portion: between terminals 3 and 4 (Y type), 5 and 6, 7 and 8 (W type);
LED current: 5 mA; Load voltage: Max. (DC);
Continuous load current: Max. (DC)

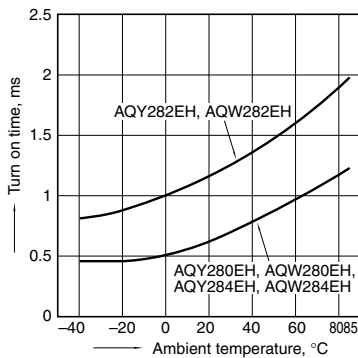

4. Turn off time vs. ambient temperature characteristics

Measured portion: between terminals 3 and 4 (Y type), 5 and 6, 7 and 8 (W type);
LED current: 5 mA; Load voltage: Max. (DC);
Continuous load current: Max. (DC)

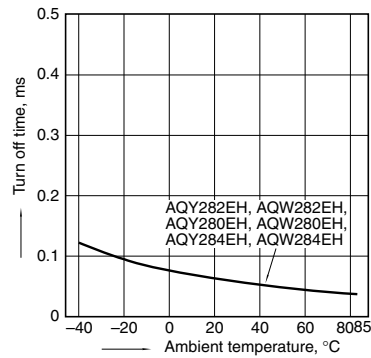

5. LED operate current vs. ambient temperature characteristics

Sample: All types; Load voltage: Max. (DC);
Continuous load current: Max. (DC)

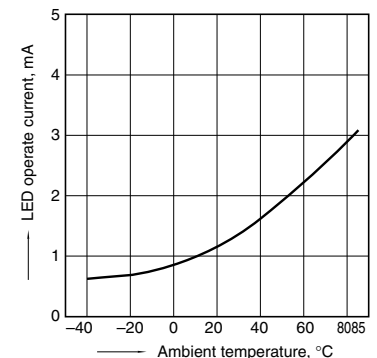

6. LED turn off current vs. ambient temperature characteristics

Sample: All types; Load voltage: Max. (DC);
Continuous load current: Max. (DC)

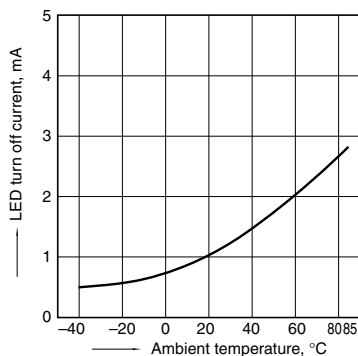

7. LED dropout voltage vs. ambient temperature characteristics

Sample: All types;
LED current: 5 to 50 mA

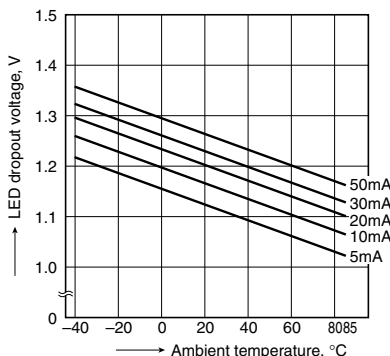

8.-(1) Current vs. voltage characteristics of output at MOS portion

Measured portion: between terminals 3 and 4 (Y type), 5 and 6, 7 and 8 (W type);
Ambient temperature: 25°C 77°F

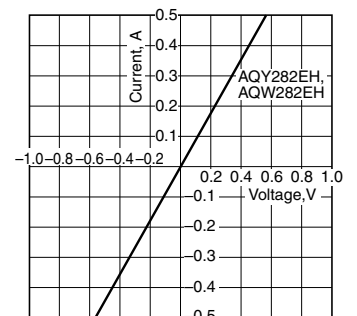

GE 1, 2 Form A (AQY, W28○EH)

8.-(2) Current vs. voltage characteristics of output at MOS portion

Measured portion: between terminals 3 and 4 (Y type), 5 and 6, 7 and 8 (W type);
Ambient temperature: 25°C 77°F

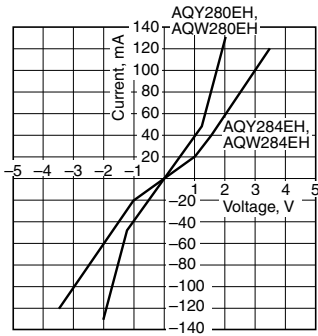

9. Off state leakage current vs. load voltage

Measured portion: between terminals 3 and 4 (Y type), 5 and 6, 7 and 8 (W type);
Sample: All types;
Ambient temperature: 25°C 77°F

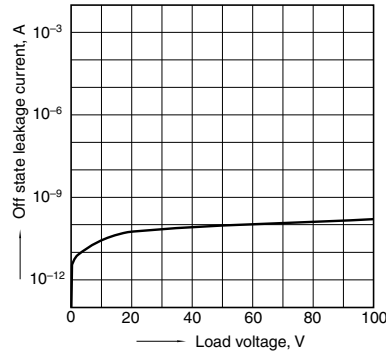

10. Turn on time vs. LED forward current characteristics

Measured portion: between terminals 3 and 4 (Y type), 5 and 6, 7 and 8 (W type);
Load voltage: Max. (DC); Continuous load current: Max. (DC); Ambient temperature: 25°C 77°F

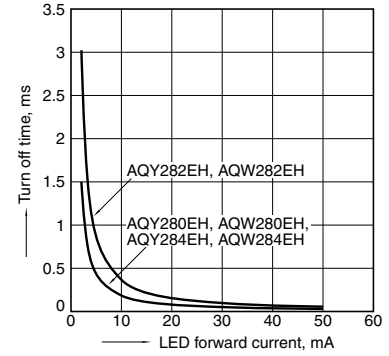

11. Turn off time vs. LED forward current characteristics

Measured portion: between terminals 3 and 4 (Y type), 5 and 6, 7 and 8 (W type);
Load voltage: Max. (DC); Continuous load current: Max. (DC); Ambient temperature: 25°C 77°F

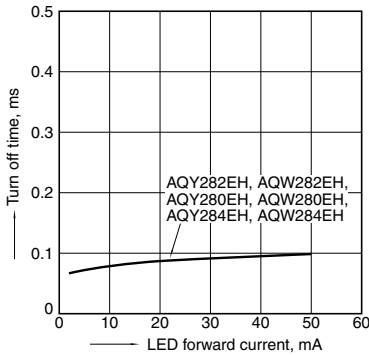

12. Output capacitance vs. applied voltage characteristics

Measured portion: between terminals 3 and 4 (Y type), 5 and 6, 7 and 8 (W type);
Frequency: 1 MHz;
Ambient temperature: 25°C 77°F

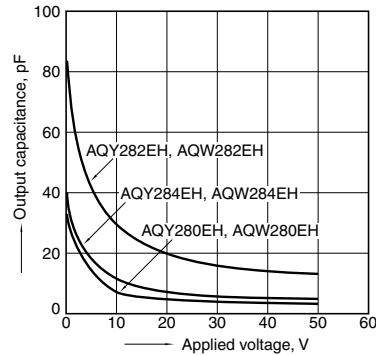

DIMENSIONS (mm inch)

AQY28○S

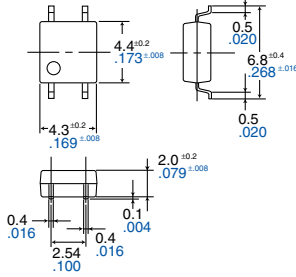

Recommended mounting pad
(Top view)

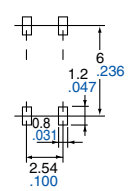

Tolerance: $\pm 0.1 \pm .004$

Terminal thickness = 0.15 .006
General tolerance: $\pm 0.1 \pm .004$

AQW28○S

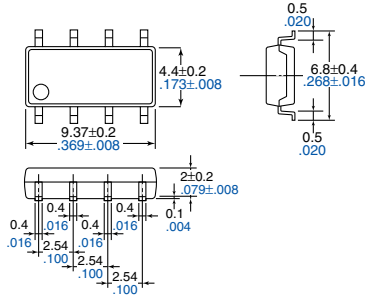

Recommended mounting pad
(Top view)

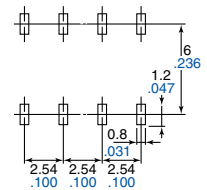

Tolerance: $\pm 0.1 \pm .004$

Terminal thickness = 0.15 .006
General tolerance: $\pm 0.1 \pm .004$

AQY28○EH(A)

Through hole terminal type

Surface mount terminal type

PC board pattern (Bottom view)

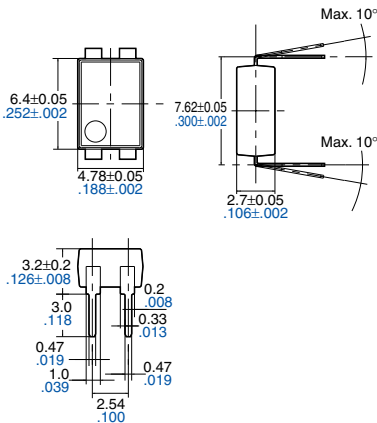

Terminal thickness = 0.2 .008
General tolerance: $\pm 0.1 \pm .004$

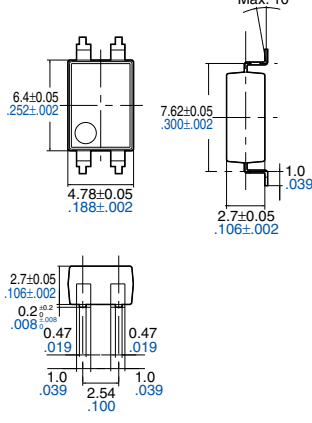

Terminal thickness = 0.2 .008
General tolerance: $\pm 0.1 \pm .004$

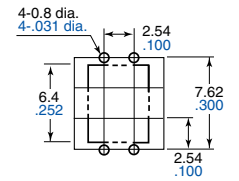

Tolerance: $\pm 0.1 \pm .004$

Mounting pad (Top view)

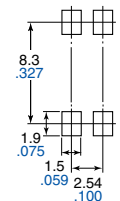

Tolerance: $\pm 0.1 \pm .004$

AQW28○EH(A)

Through hole terminal type

Surface mount terminal type

PC board pattern
(Bottom view)

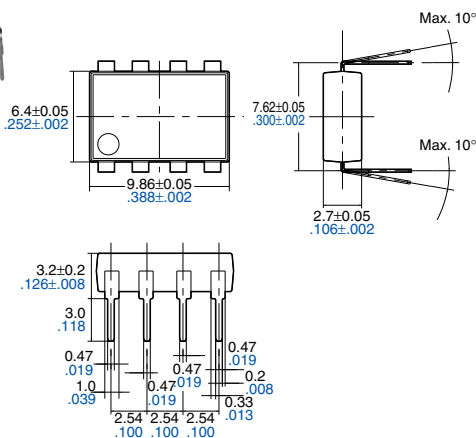

Terminal thickness = 0.2 .008
General tolerance: $\pm 0.1 \pm .004$

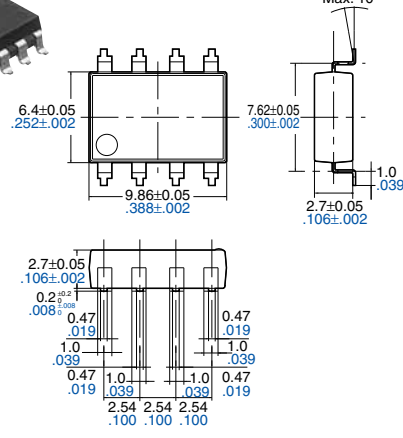

Terminal thickness = 0.2 .008
General tolerance: $\pm 0.1 \pm .004$

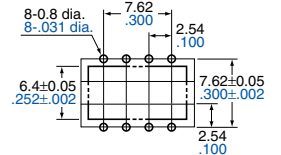

Tolerance: $\pm 0.1 \pm .004$

Mounting pad (Top view)

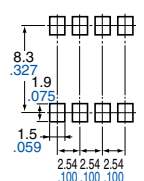

Tolerance: $\pm 0.1 \pm .004$

SCHEMATIC AND WIRING DIAGRAMS

AQY28 (SOP), AQY28 Series

E₁: Power source at input side; I_F: LED forward current; I_L: Load current

Schematic	Output configuration	Load	Wiring diagram
	1a	AC/DC	

AQW28 (SOP), AQW28 Series

E₁: Power source at input side; V_{IN}: Input voltage; I_F: LED forward current; I_{IN}: Input current; V_L: Load voltage; I_L: Load current

Schematic	Output configuration	Load	Wiring diagram
	2a	AC/DC	<p>(1) Two independent 1 Form A use</p> <p>(2) 2 Form A use</p>

PhotoMOS® CAUTIONS FOR USE SAFETY WARNINGS

- Do not use the product under conditions that exceed the range of its specifications. It may cause overheating, smoke, or fire.

- Do not touch the recharging unit while the power is on. There is a danger of electrical shock. Be sure to turn off the power when performing mounting, maintenance, or repair operations on the relay (including connecting parts such as the terminal board and socket).

- Check the connection diagrams in the catalog and be sure to connect the terminals correctly. Erroneous connections could lead to unexpected operating errors, overheating, or fire.

1. Applying stress that exceeds the absolute maximum rating

If the voltage or current value for any of the terminals exceeds the absolute maximum rating, internal elements will deteriorate because of the overvoltage or overcurrent. In extreme cases, wiring may melt, or silicon P/N junctions may be destroyed.

Therefore, the circuit should be designed in such a way that the load never exceed the absolute maximum ratings, even momentarily.

2. Derating design

Derating is essential in any reliable design and is a significant factor for product life.

Even if the conditions of use (temperature, current, voltage, etc.) of the product fall within the absolute maximum ratings, reliability can be reduced remarkably when continually used under high load (high temperature, high humidity, high current, high voltage, etc.). Therefore, please derate sufficiently below the absolute maximum rating and verify operation of the actual design before use.

Also, if there is the possibility that the inferior quality of this product could possibility cause great adverse affect on human life or physical property we recommend that, from the perspective of a manufacturer's liability, sufficient amount of derating to be added to the maximum rating value and implement safety measures such as fail-safe circuit.

3. Short across terminals

Do not short circuit between terminals when relay is energized, since there is possibility of breaking of the internal IC.

4. Surge voltages at the input

If reverse surge voltages are present at the input terminals, connect a diode in reverse parallel across the input terminals and keep the reverse voltages below the reverse breakdown voltage.

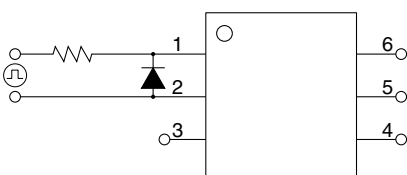

5. Recommended LED forward current (I_F)

It is recommended that the LED forward current (I_F) of each PhotoMOS Relay should be set according to the following table.

Product name	Recommended LED forward current (I _F)
AQY28OS AQW28OS	5 mA
AQY28OEH AQW28OEH	5 to 10 mA

6. LED current vs. ambient temperature characteristics

Please keep the LED current to within the range given below.

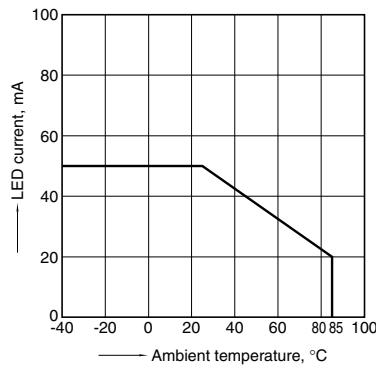

7. Ripple in the input power supply

If ripple is present in the input power supply, observe the following:

- For LED operate current at E_{min}, maintain the value mentioned in the table of "5. Recommended LED forward current (I_F)."
- Keep the LED operate current at 50 mA or less at E_{max}.

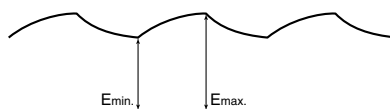

8. Output spike voltages

1) If an inductive load generates spike voltages which exceed the absolute maximum rating, the spike voltage must be limited.

Typical circuits are shown below.

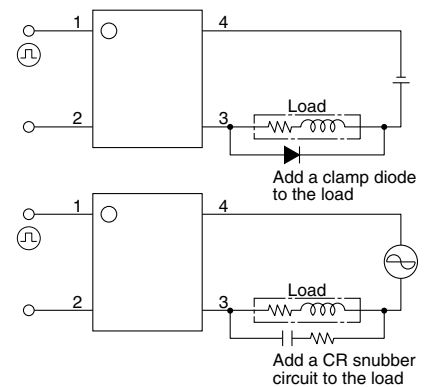

2) Even if spike voltages generated at the load are limited with a clamp diode if the circuit wires are long, spike voltages will occur by inductance. Keep wires as short as possible to minimize inductance.

9. Cleaning solvents compatibility

We recommend cleaning with an organic solvent. If you cannot avoid using ultrasonic cleansing, please ensure that the following conditions are met, and check beforehand for defects.

- Frequency: 27 to 29 kHz
- Ultrasonic output: No greater than 0.25W/cm²
- Cleaning time: No longer than 30 s
- Cleanser used: Asahiklin AK-225
- Other: Submerge in solvent in order to prevent the PCB and elements from being contacted directly by the ultrasonic vibrations.

Note: Applies to unit area ultrasonic output for ultrasonic baths.

10. Notes for mounting

1) If many different packages are combined on a single substrate, then lead temperature rise is highly dependent on package size. For this reason, please make sure that the temperature of the terminal solder area of the PhotoMOS® falls within the temperature conditions of item "11. Soldering" before mounting.

2) If the mounting conditions exceed the recommended solder conditions in item 10, resin strength will fall and the nonconformity of the heat expansion coefficient of each constituent material will increase markedly, possibly causing cracks in the package, severed bonding wires, and the like. For this reason,

please inquire with us about whether this use is possible.

11. Soldering

1) When soldering PC board terminals, keep soldering time to within 10 s at 260°C 500°F.

2) When soldering surface-mount terminals, the following conditions are recommended.

(1) IR (Infrared reflow) soldering method

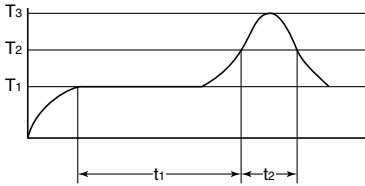

T₁ = 150 to 180°C 302 to 356°F
 T₂ = 230°C 446°F
 T₃ = 250°C 482°F or less
 t₁ = 60 to 120 s or less
 t₂ = 30 s or less

(2) Soldering iron method

Tip temperature: 350 to 400°C 662 to 752°F

Wattage: 30 to 60 W

Soldering time: within 3 s

(3) Others

Check mounting conditions before using other soldering methods (DWS, VPS, hot-air, hot plate, laser, pulse heater, etc.)

- When using lead-free solder, we recommend a type with an alloy composition of Sn 3.0 Ag 0.5 Cu. Please inquire about soldering conditions and other details.

- The temperature profile indicates the temperature of the soldered terminal on the surface of the PC board. The ambient temperature may increase excessively. Check the temperature under mounting conditions.

12. The following shows the packaging format

1) Tape and reel

mm imch

Type	Tape dimensions	Dimensions of paper tape reel
SOP 4-pin	<p>(1) When picked from 1/2-pin side: Part No. AQY*<i>SX</i> (Shown above) (2) When picked from 3/4-pin side: Part No. AQY*<i>SZ</i></p>	
SOP 8-pin	<p>(1) When picked from 1/2/3/4-pin side: Part No. AQW*<i>SX</i> (Shown above) (2) When picked from 5/6/7/8-pin side: Part No. AQW*<i>SZ</i></p>	

Notes: "*" indicates two or more characters of number or alphabet.
 "○" indicates a single-digit figure.

Type	Tape dimensions	Dimensions of paper tape reel
DIP 4-pin Surface mount terminal	<p>(1) When picked from 1/2-pin side: Part No. AQY*HAX (Shown above) (2) When picked from 3/4-pin side: Part No. AQY*HAZ</p>	
DIP 8-pin Surface mount terminal (Reinforced insulation type)	<p>(1) When picked from 1/2/3/4-pin side: Part No. AQW○○○EHAX (Shown above) (2) When picked from 5/6/7/8-pin side: Part No. AQW○○○EHAZ</p>	

Notes: "*" indicates two or more characters of number or alphabet.
"○" indicates a single-digit figures.

2) Tube

Devices are packaged in a tube so pin No. 1 is on the stopper B side. Observe correct orientation when mounting them on PC boards.

(DIP type)

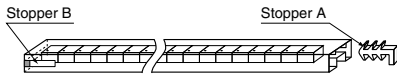

(SOP type)



13. Transportation and storage

- 1) Extreme vibration during transport will warp the lead or damage the device. Handle the outer and inner boxes with care.
- 2) Storage under extreme conditions will cause soldering degradation, external appearance defects, and deterioration of the characteristics. The following storage conditions are recommended:
 - Temperature: 0 to 45°C 32 to 113°F
 - Humidity: Less than 70% R.H.
 - Atmosphere: No harmful gasses such as sulfuro acid gas, minimal dust.
- 3) PhotoMOS[®] implemented in VSSOP, SON, SSOP, SOP are sensitive to moisture and come in sealed moisture-proof packages. Observe the following cautions on storage.
 - After the moisture-proof package is unsealed, take the devices out of storage as soon as possible (within 1 month ≤ 45°C/70% R.H.).
 - If the devices are to be left in storage for a considerable period after the moisture-proof package has been unsealed, it is recommended to keep them in another moisture-proof bag containing silica gel (within 3 months at the most).

Please contact

Panasonic Corporation

Automation Controls Business Division

■ Head Office: 1048, Kadoma, Kadoma-shi, Osaka 571-8686, Japan
industrial.panasonic.com/ac/e/

Panasonic[®]

©Panasonic Corporation 2014