

MP-1616-2103 Color SMD LED



Table of Contents

Technology Overview	2
Product Selection Table	3
Operating Characteristics	4
Chromaticity Binning	5
Chromaticity Diagram	6
Characteristic Graphs	7 & 8
Ordering Information	9
Product Dimensions	10
Solder Pad Pattern	10
Dimensions of Tape	11
Reel Dimensions	12
Reel Packaging	12
Box Packaging	13

Features:

- Wide viewing angle: 135 degrees
- 1.63W maximum operating input power
- Compact: 1.6mm x 1.6mm
- High efficacy: up to 143 lumens per watt
- Colors: Semiconductor blue, phosphor converted green, phosphor converted red
- 6V input
- Compatible with automatic placement equipment
- Compatible with infrared reflow solder process
- RoHs and REACH compliant

Applications

- | | |
|---------------------|--------------------------|
| • Replacement lamps | • Cove lighting |
| • Panel lighting | • Architectural lighting |
| • Down lights | • Channel lighting |

Technology Overview

Luminus Luminus Cube™ LEDs are lighting class solutions designed for high performance general lighting applications. These state-of-the-art LEDs allow illumination engineers and designers to develop lighting solutions with maximum efficacy, brightness and overall quality. The Luminus Cube™ is a unique LED that provides the benefits of a wide emission angle within a compact footprint. The 1.6mm x 1.6mm package emits into a 135 degree viewing angle, enabling designers with new degrees of freedom to solve many of today's most challenging lighting problems. The very wide viewing angle promotes Energy Star compliance for replacement lamps, and results in increased mixing and uniformity for linear and area lighting. The miniature package size with high lumen density creates a "point source" of light that provides flexibility to develop innovative optical solutions. Additionally, the Luminus Cube advances the hallmark characteristics of the Luminus family, including high efficacy and color fidelity. Luminus LEDs – the right choice for color quality, efficacy and reliability.

Reliability

The Luminus Cube is one of the most reliable light sources in the world today. Having passed a rigorous suite of environmental and mechanical stress tests, including mechanical shock, vibration, temperature cycling and humidity, it is fully qualified for use in a wide range of high performance and high efficacy lighting applications.

REACH & RoHS Compliance

The Luminus Cube LED is compliant to the Restriction of Hazardous Substances Directive or RoHS.

Understanding Luminus™ LED Test Specifications

Every Luminus LED is fully tested to ensure it meets the high quality standards customers have come to expect from Luminus products.

Testing Temperature

Luminus Cube MP-1616 LEDs are tested and binned at 25°C

Product Selection Table

Test condition = 150 mA, 25C

Color	Dominant Wavelength	Ordering Part Number	Minimum Flux (Lumens)	Typical Flux (Lumens)
ROYAL BLUE	455-460nm	MP-1616-2103-RB	17	20
GREEN	525-540nm	MP-1616-2103-PG	130	138
RED	620-630nm	MP-1616-2103-PR	18	22

1616 Mid Power Operating Characteristics

Optical and Electrical Characteristics(Ta=25°C)

Parameter	Symbol	Minimum	Typical	Maximum	Unit	Condition
Forward Voltage	V _F		6.2	6.3	V	I _F =150mA
Reverse Current	I _R			10	uA	V _R =5V
Viewing Angle	2θ _{1/2}		135		°	I _F =150mA
Thermal Resistance	R _{th(j-sp)}		12		°C/W	I _F =150mA
Electrostatic Discharge	ESD	1000			V	

Note 1: To prevent damage refer to operating conditions and derating curves for appropriate maximum operating conditions

Note 2: Maximum operating case temperature combined with maximum drive current defines the total maximum operating condition for the device. To prevent damage, please follow derating curves for all operating conditions.

Note 3: Luminus Cube are designed for operation up to an absolute maximum forward drive current as specified below. Product lifetime data is specified at typical forward drive currents. Sustained operation at absolute maximum currents will result in a reduction of device lifetime compared to typical forward drive currents. Actual device lifetimes will also depend on case temperature. Refer to the current vs. case temperature derating curves for further information.

Note 4: Caution must be taken not to stare at the light emitted from these LEDs. Under special circumstances, the high intensity could damage the eye.

Absolute Maximum Ratings (Ta=25°C)

Parameter	Symbol	Rating	Unit
Forward Current	I _F	200	mA
Pulse Forward Current	I _{FP}	300	mA
Power Dissipation	P _D	1,632	mW
Reverse Voltage	V _R	5	V
Operating Temperature	T _{OPR}	-40~+80	°C
Storage Temperature	T _{STG}	-40~+80	°C
Junction Temperature	T _J	125	°C
Soldering Temperature	T _{SLD}	230 °C or 260 °C for 10 sec	

*I_{FP} condition with Pulse: Width ≤100μs Duty cycle ≤1/10

Dominant Wavelength Binning**Dominant Wavelength Color Bins @ $T_c=25^\circ\text{C}$**

COLOR	bin code	Dominant Wavelength(nm)	
		min	max
ROYAL BLUE	B1	455	460
GREEN	G1	520	525
	G2	525	530
	G3	530	535
	G4	535	540
RED	R1	620	625
	R2	625	630

Notes: Tolerance of measurements of dominant wavelength is $\pm 1.5\text{nm}$

this page intentionally left blank

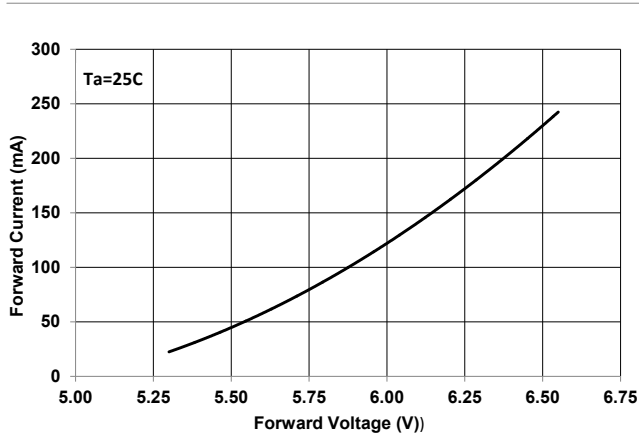
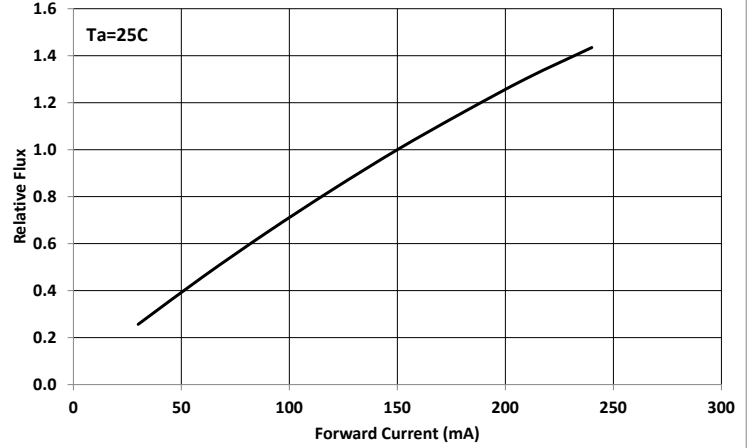
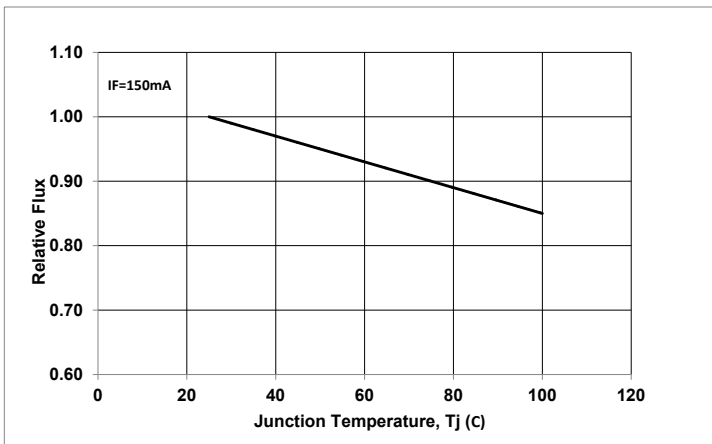
Typical Optical/Electrical Characteristics Graphs
Vf-----IF

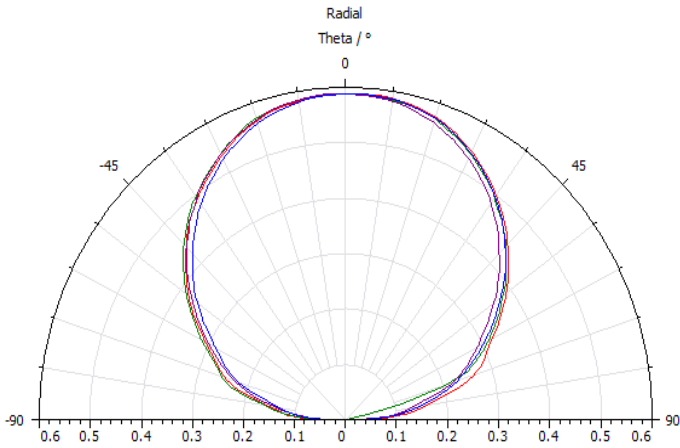
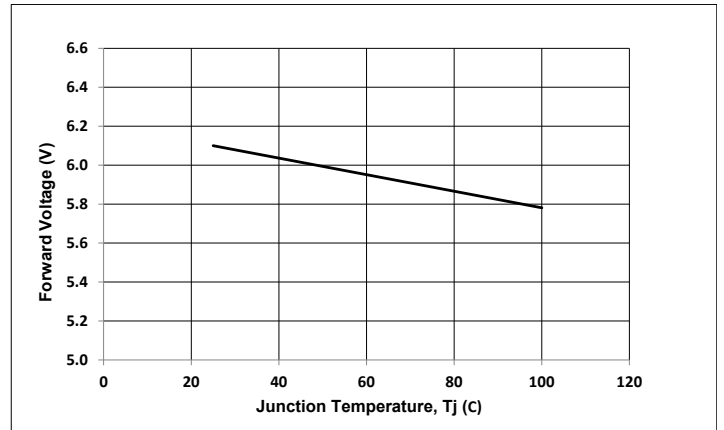
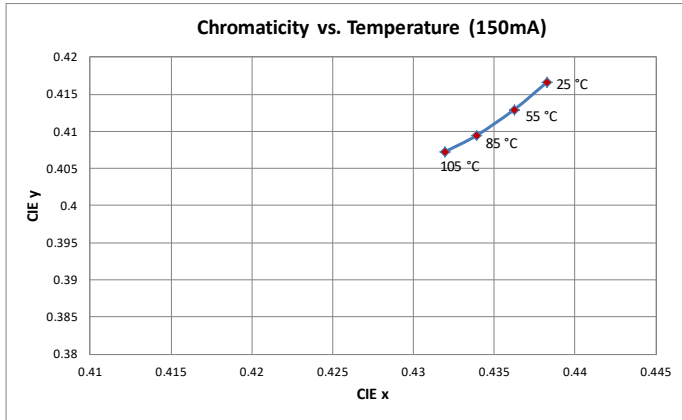
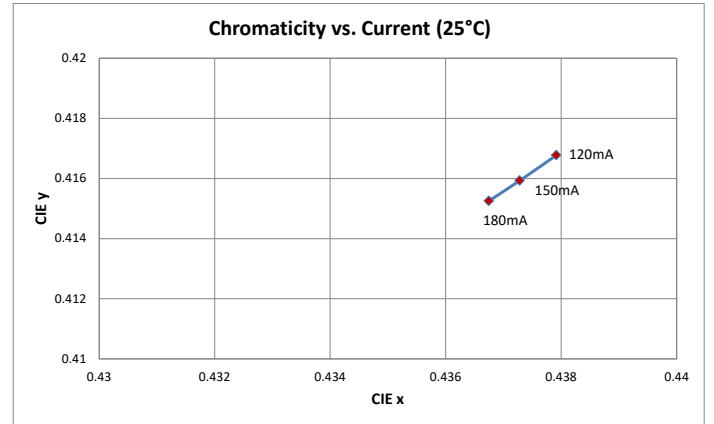
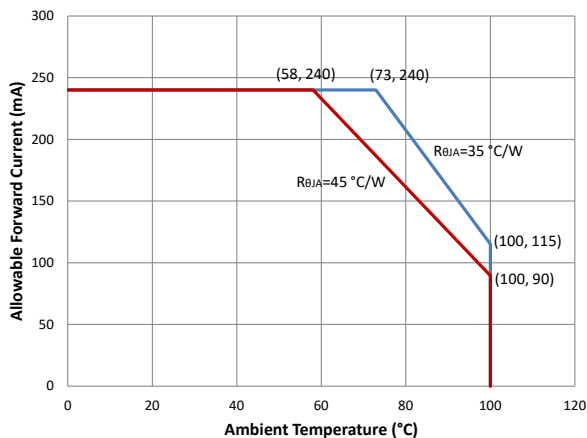
IF---- Relative Luminous flux

Tj-----Relative Luminous Flux

Typical Optical/Electrical Characteristics Graphs
Typical Polar Radiation Pattern

T_j -- Forward Voltage

Chromaticity vs Temperature

Chromaticity vs Current

Current vs T_j

Product Ordering and Shipping Part Number Nomenclature

All Luminus Cube products are packaged and labeled with part numbers as outlined in below. When shipped, each reel will contain only a single flux and voltage bin. The part number designation is as follows:

1616 Luminus Cube LEDs

Luminus Cube	Package Type	Package Configurator	Color
MP	1616	2103	RG, PG, or PR

Example:

The part number MP-1616-2100-RB refers to a Royal Blue Luminus Cube emitter

Each mid power product shipped will be labeled with its specific flux and voltage bins. Not all bins listed are available in all colors.

Luminus Flux Bins (Ta= 25°C)

Bin Code	Minimum Flux (Lumens)	Maximum Flux (Lumens)
D2	18	20
D3	22	24
D4	24	26
D5	26	28
D6	28	30
2F	130	139
2G	139	148

Forward Voltage Bins (Ta=25°C)

Bin Code	Minimum Voltage (Volts)	Maximum Voltage (Volts)
B	5.9	6.1
C	6.1	6.3
D	6.3	6.5

*Tolerance of measurements f the Forward Voltage is $\pm 0.1V$

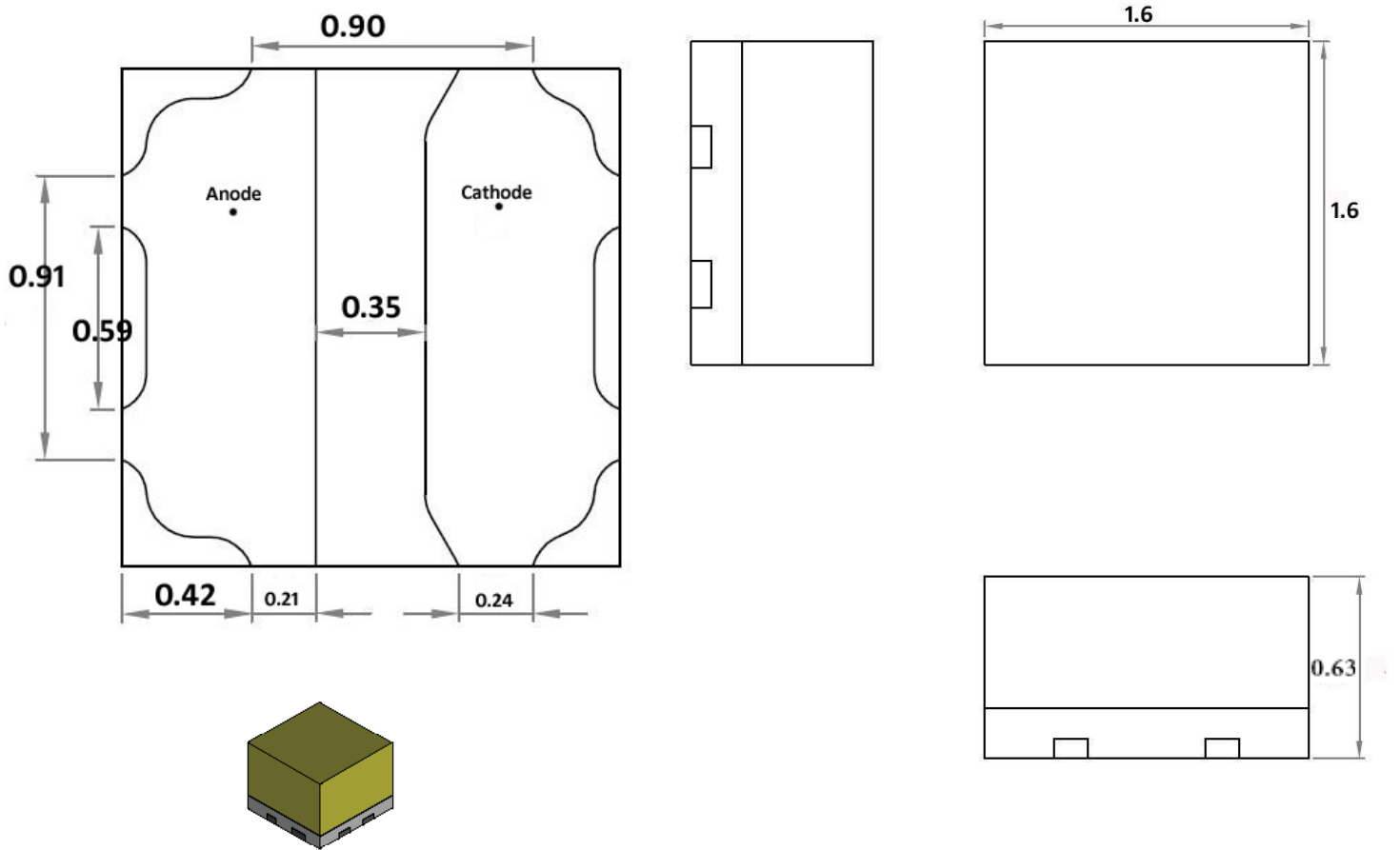
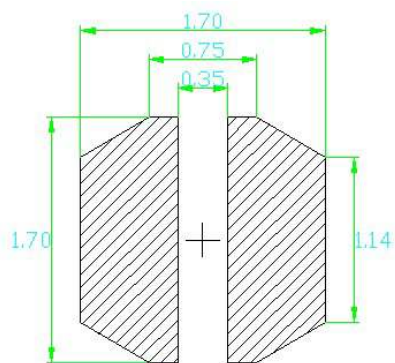
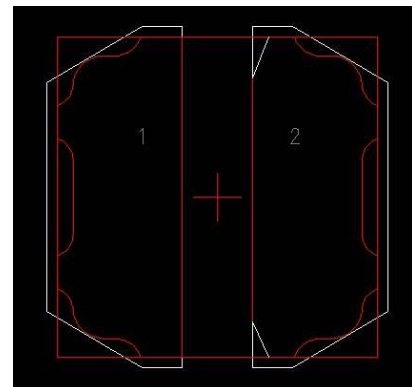
Product Dimensions (mm)

Recommended Soldering Pad Pattern

Recommended Solder Pad

Effect Picture

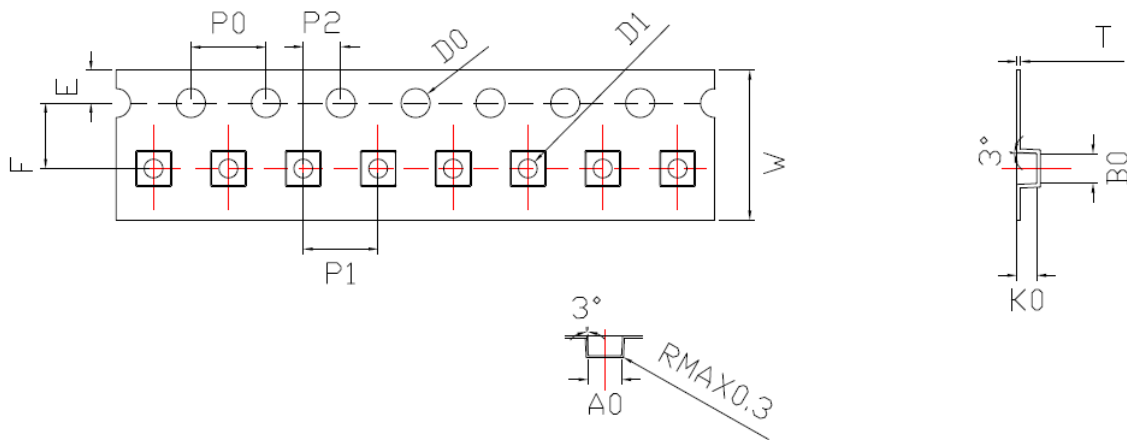
- All dimensions are in millimeters.
- Scale : 1:1
- Undefined tolerance is $\pm 0.1\text{mm}$

Dimensions of tape (mm)

symbol	A0	BO	KO	PO	P1	P2
Spec	1.80±0.05	1.80±0.05	1.0±0.05	4.00±0.10	4.0±0.1	2.0±0.05
symbol	W	T	E	F	DO	D1
Spec	8.0±0.2	0.20±0.05	1.75±0.10	3.5±0.1	1.90±0.1/-0	1.90±0.1/-0



Reel Dimensions (mm)

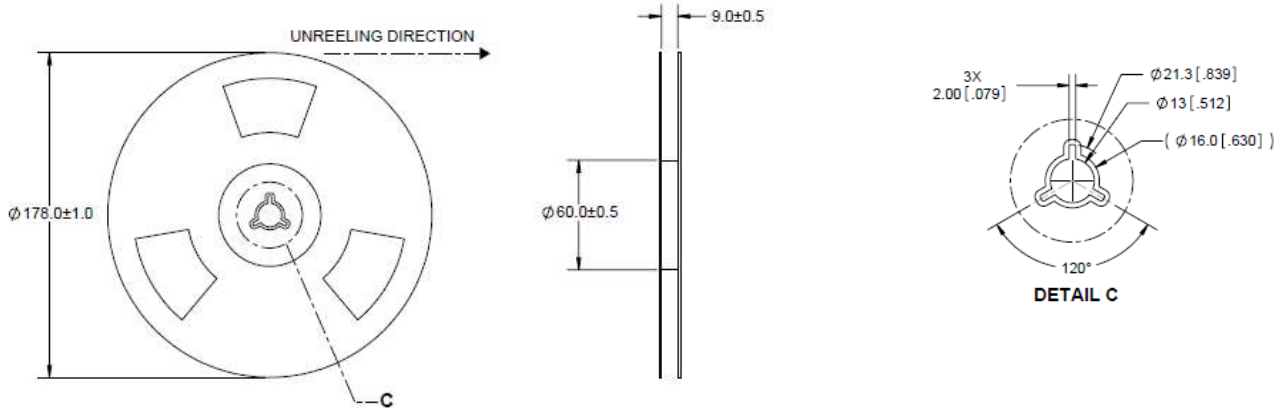

Reel Packaging

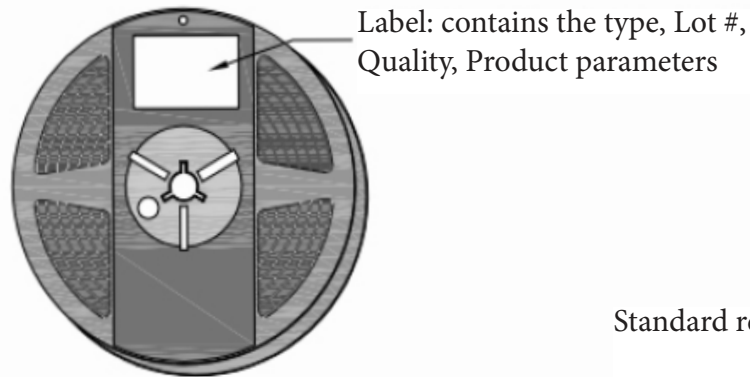

Standard reel quantity: 3000 pcs

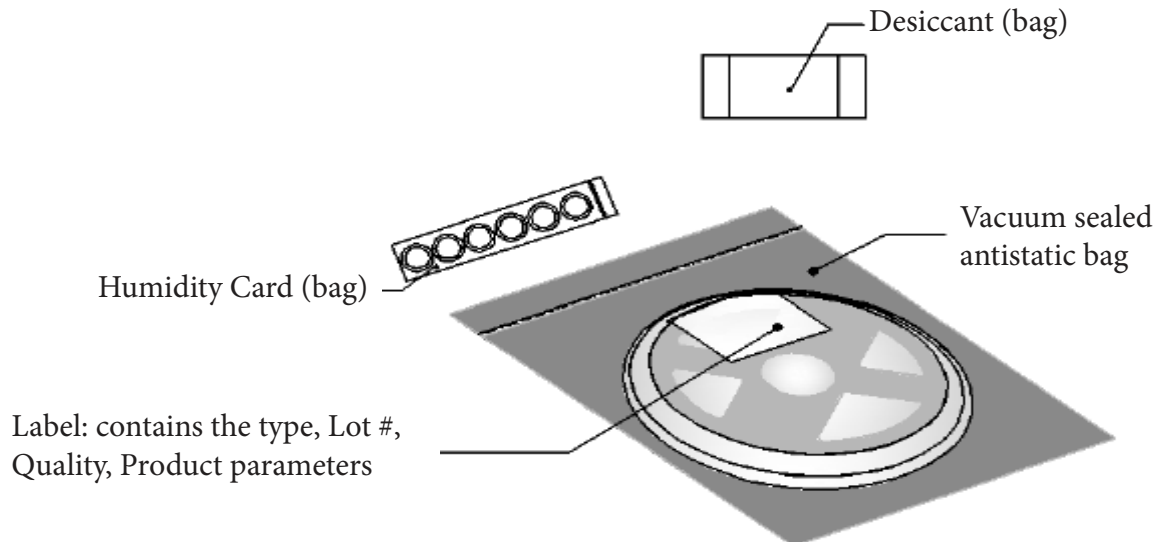

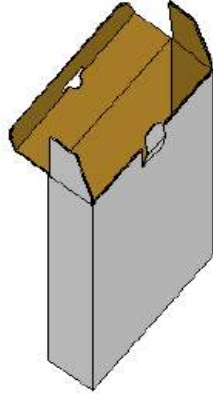
Box Packaging Information

*Capacity 5 reels per box

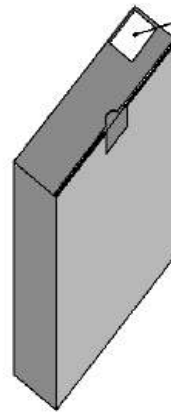

Label: contains the type,
Lot #, Quality, Product
parameters



*Capacity 10 reels per box



Label: contains the type,
Lot #, Quality, Product
parameters

Precaution for Use

Storage:

1. This device is rated at MSL 3 per JEDEC J-STD-020 standard.
2. Recommended storage condition:
At 5 °C- 30 °C and relative humidity 60% RH in its original package
3. After this bag is opened, devices that will be applied to infrared reflow, vapor - phase reflow, or equivalent soldering process must be:
 - a) Completed within 168 hours
 - b) Stored at less than 60%RH
 - c) If not completely used within 168 hours, seal the remaining in the moisture barrier bag
4. Devices require baking before mounting, if 3 a) is not met.
5. If baking is required, devices must be baked under below conditions:
24 hours at 60C+/-5C

Static Electricity:

1. The products are sensitive to static electricity, and care should be taken when handling them.
2. Static electricity or surge voltage will damage the LEDs. It is recommended to wear a anti-electrostatic wristband or an anti-electrostatic gloves when handling the LEDs.
3. All devices, equipment and machinery must be properly grounded. It is recommended that measures be taken against surge voltage to the equipment that mounts the LEDs.

Change of History

Date	Rev	Change details
2-11-2020	NA	first draft