

PCM6480-Q1 Automotive, 8-Channel, 768-kHz, Audio ADC With Integrated Microphone Bias and Input Fault Diagnostics

1 Features

- AEC-Q100 qualified for automotive applications
 - Temperature grade 1: $-40^{\circ}\text{C} \leq T_A \leq +125^{\circ}\text{C}$
- Simultaneous conversion of upto 8-channel audio
 - 4-channel analog microphone or line inputs
 - 4-channel digital PDM microphone inputs
- ADC performance:
 - Line differential input dynamic range: 110 dB
 - Microphone differential input dynamic range: 110 dB
 - THD+N: -95 dB
- ADC analog input voltage:
 - Differential, $10\text{-}V_{\text{RMS}}$ full-scale inputs
 - Single-ended, $5\text{-}V_{\text{RMS}}$ full-scale inputs
- ADC sample rate (f_s) = 8 kHz to 768 kHz
- Programmable channel settings:
 - Analog input channel gain: 0 dB to 42 dB
 - Digital volume control: -100 dB to 27 dB
 - Gain calibration with 0.1-dB resolution
 - Phase calibration with 163-ns resolution
- Programmable microphone bias (5 V to 9 V)
- Programmable microphone analog input fault diagnostics:
 - Open inputs or shorted inputs
 - Short to ground, MICBIAS or VBAT
 - Microphone bias over current protection
- Low-latency signal processing filter selection
- Programmable HPF and biquad digital filters
- I²C or SPI controls
- Audio serial data interface:
 - Format: TDM, I²S, or left-justified (LJ)
 - Word length: 16 bits, 20 bits, 24 bits, or 32 bits
 - Master or slave interface
- Single-supply, 3.3-V operation
- I/O supply operation: 3.3 V or 1.8 V
- Power consumption:
 - < 20 mW/channel at 48-kHz

2 Applications

- [Automotive active noise cancellation](#)
- [Automotive head units](#)
- [Digital cockpit processing units](#)
- [Automotive external amplifiers](#)

3 Description

The PCM6480-Q1 is a high-performance audio converter that supports simultaneous sampling of up to a 4-channel analog microphone or a line input with up to a 4-channel digital pulse density-modulation (PDM) microphone input. The device integration enables both in-cabin active noise cancellation (ANC) and voice recognition (VR) applications in a very efficient manner by simultaneously using the analog and digital microphone input sampling. The PCM6480-Q1 consists of high-performance, audio analog-to-digital converters (ADCs) that support analog input signals up to $10 V_{\text{RMS}}$. The device offers an integrated high-voltage, programmable microphone bias, and input diagnostic circuitry that allow direct connection to microphone-based automotive systems with full fault diagnostic capability for DC-coupled inputs. The device integrates an efficient boost converter to generate a high voltage microphone bias using an external, low-voltage, 3.3-V supply. The PCM6480-Q1 integrates the programmable channel gain, digital volume control, a low-jitter phase-locked loop (PLL), a programmable high-pass filter (HPF), biquad filters, low-latency filter modes, and allows for sample rates up to 768 kHz. The PCM6480-Q1 supports time-division multiplexing (TDM), I²S, or left-justified (LJ) audio formats, and can be controlled with either the I²C or SPI interface.

Device Information

| PART NUMBER ⁽¹⁾ | PACKAGE | BODY SIZE (NOM) |
|----------------------------|-----------|--|
| PCM6480-Q1 | WQFN (32) | 5.00 mm x 5.00 mm with 0.5-mm pitch |

- (1) For all available packages, see the orderable addendum at the end of the data sheet.

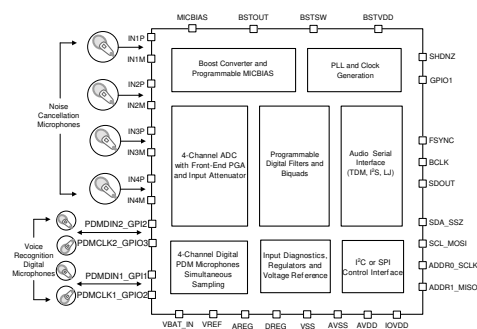

Simplified Application Diagram

Table of Contents

| | | | |
|--|----------|--|------------|
| 1 Features | 1 | 8 Detailed Description | 21 |
| 2 Applications | 1 | 8.1 Overview..... | 21 |
| 3 Description | 1 | 8.2 Functional Block Diagram..... | 22 |
| 4 Revision History | 2 | 8.3 Feature Description..... | 23 |
| 5 Device Comparison Table | 3 | 8.4 Device Functional Modes..... | 63 |
| 6 Pin Configuration and Functions | 4 | 8.5 Programming..... | 64 |
| 7 Specifications | 6 | 8.6 Register Maps..... | 68 |
| 7.1 Absolute Maximum Ratings | 6 | 9 Application and Implementation | 152 |
| 7.2 ESD Ratings | 6 | 9.1 Application Information..... | 152 |
| 7.3 Recommended Operating Conditions | 6 | 9.2 Typical Application..... | 153 |
| 7.4 Thermal Information | 7 | 9.3 What To Do and What Not To Do..... | 157 |
| 7.5 Electrical Characteristics | 7 | 10 Power Supply Recommendations | 158 |
| 7.6 Timing Requirements: I ² C Interface | 11 | 11 Layout | 159 |
| 7.7 Switching Characteristics: I ² C Interface | 12 | 11.1 Layout Guidelines..... | 159 |
| 7.8 Timing Requirements: SPI Interface | 13 | 11.2 Layout Example..... | 160 |
| 7.9 Switching Characteristics: SPI Interface | 13 | 12 Device and Documentation Support | 161 |
| 7.10 Timing Requirements: TDM, I ² S or LJ Interface | 13 | 12.1 Device Support..... | 161 |
| 7.11 Switching Characteristics: TDM, I ² S or LJ Interface | 14 | 12.2 Documentation Support..... | 161 |
| 7.12 Timing Requirements: PDM Digital Microphone Interface | 14 | 12.3 Receiving Notification of Documentation Updates | 161 |
| 7.13 Switching Characteristics: PDM Digital Microphone Interface | 15 | 12.4 Support Resources..... | 161 |
| 7.14 Timing Diagrams..... | 15 | 12.5 Trademarks..... | 161 |
| 7.15 Typical Characteristics..... | 17 | 12.6 Electrostatic Discharge Caution..... | 161 |
| | | 12.7 Glossary..... | 161 |
| | | 13 Mechanical, Packaging, and Orderable Information | 162 |

4 Revision History

NOTE: Page numbers for previous revisions may differ from page numbers in the current version.

| DATE | REVISION | NOTES |
|---------------|----------|------------------|
| December 2020 | * | Initial release. |

5 Device Comparison Table

| FEATURE | PCM6020-Q1 | PCM6240-Q1 | PCM6260-Q1 | PCM6480-Q1 | PCM6340-Q1 | PCM6360-Q1 |
|--------------------------------------|--|------------|------------|------------------------------------|--|------------|
| Control interface | I ² C or SPI | | | | | |
| Digital audio serial interface | TDM or I ² S or left-justified (LJ) | | | | | |
| Audio analog channel | 2 | 4 | 6 | 4 | 4 | 6 |
| Audio PDM input channel | 0 | 0 | 0 | 4 | 0 | 0 |
| General-purpose input or output pins | 5 | 5 | 1 | 5 (multiplexed with PDM interface) | 5 | 1 |
| Microphone bias voltage | Programmable 5 V to 9 V in steps of 0.5 V | | | | | |
| Microphone bias LDO supply | Generated using integrated efficient boost converter with external low-voltage BSTVDD = 3.3-V supply | | | | Powered directly using external high-voltage HVDD (as high as 12 V) supply | |
| Input fault diagnostics | Comprehensive input fault diagnostics for DC-coupled microphone inputs with programmable thresholds | | | | | |
| Package | WQFN (RTV), 32-pin, 5.00 mm x 5.00 mm (0.5-mm pitch) | | | | | |
| Compatibility | Package, and control registers compatible; replacements of each other. See the Scalable Automotive Audio Solutions Using the PCM6xx0-Q1 Family of Products application report for further details. | | | | | |

6 Pin Configuration and Functions

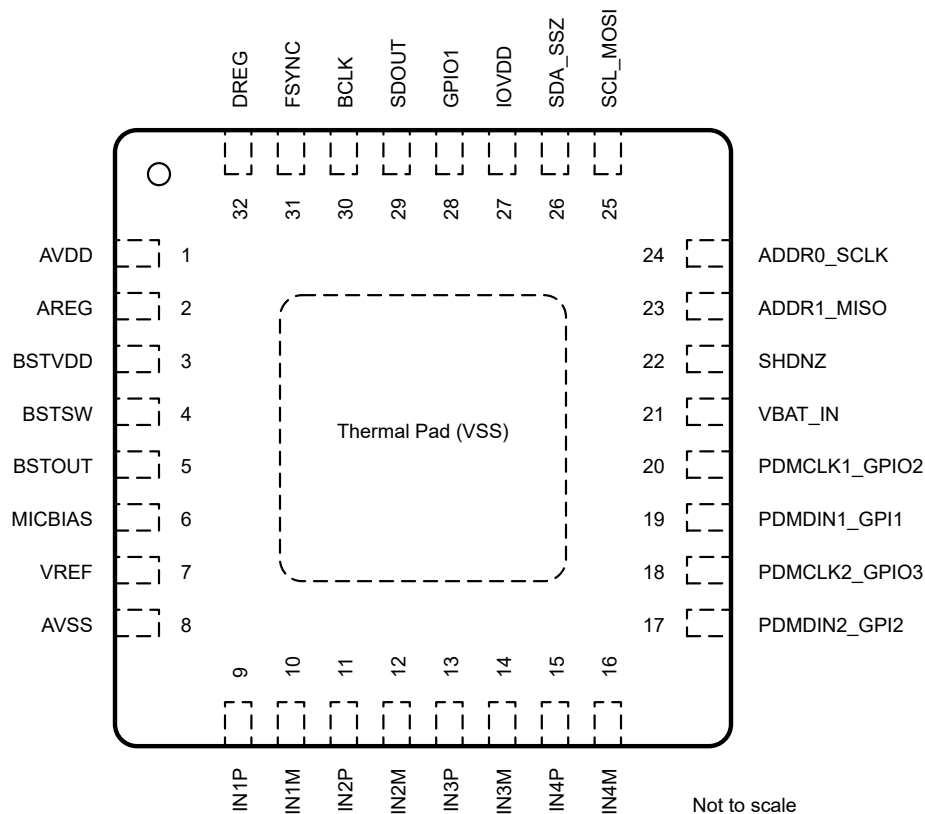

Figure 6-1. RTV Package, 32-Pin WQFN With Exposed Thermal Pad, Top View

Table 6-1. Pin Functions

| PIN | | TYPE | DESCRIPTION |
|-----|---------|---------------|--|
| NO. | NAME | | |
| 1 | AVDD | Analog supply | Analog power (3.3 V, nominal) |
| 2 | AREG | Analog supply | Analog on-chip regulator output voltage for analog supply (1.8 V, nominal) |
| 3 | BSTVDD | Analog supply | Boost converter supply voltage (3.3 V, nominal) |
| 4 | BSTSW | Analog supply | Boost converter switch input |
| 5 | BSTOUT | Analog supply | Boost converter output voltage |
| 6 | MICBIAS | Analog | MICBIAS output (programmable output up to 9 V) |
| 7 | VREF | Analog | Analog reference voltage filter output |
| 8 | AVSS | Analog supply | Analog ground; short directly to the board ground plane |
| 9 | IN1P | Analog input | Analog input 1P pin |
| 10 | IN1M | Analog input | Analog input 1M pin |

Table 6-1. Pin Functions (continued)

| PIN | | TYPE | DESCRIPTION |
|-------------------|---------------|----------------|--|
| NO. | NAME | | |
| 11 | IN2P | Analog input | Analog input 2P pin |
| 12 | IN2M | Analog input | Analog input 2M pin |
| 13 | IN3P | Analog input | Analog input 3P pin |
| 14 | IN3M | Analog input | Analog input 3M pin |
| 15 | IN4P | Analog input | Analog input 4P pin |
| 16 | IN4M | Analog input | Analog input 4M pin |
| 17 | PDMDIN2_GPI2 | Digital input | PDM microphone data input 2 or general-purpose digital input 2 (multipurpose functions such as daisy-chain input, PLL input clock source, and so forth) |
| 18 | PDMCLK2_GPIO3 | Digital I/O | PDM microphone clock output 2 or general-purpose digital input/output 3 (multipurpose functions such as daisy-chain input, audio data output, PLL input clock source, interrupt, and so forth) |
| 19 | PDMDIN1_GPI1 | Digital input | PDM microphone data input 1 or general-purpose digital input 1 (multipurpose functions such as daisy-chain input, PLL input clock source, and so forth) |
| 20 | PDMCLK1_GPIO2 | Digital I/O | PDM microphone clock output 1 or general-purpose digital input/output 2 (multipurpose functions such as daisy-chain input, audio data output, PLL input clock source, interrupt, and so forth) |
| 21 | VBAT_IN | Analog | Analog VBAT input monitoring pin (used for input diagnostics) |
| 22 | SHDNZ | Digital input | Device hardware shutdown and reset (active low) |
| 23 | ADDR1_MISO | Digital I/O | For I ² C operation: I ² C slave address A1 pin. For SPI operation: SPI slave output pin. |
| 24 | ADDR0_SCLK | Digital input | For I ² C operation: I ² C slave address A0 pin. For SPI operation : SPI serial bit clock. |
| 25 | SCL_MOSI | Digital input | For I ² C operation: clock pin for I ² C control bus. For SPI operation: SPI slave input pin. |
| 26 | SDA_SSZ | Digital I/O | For I ² C operation: data pin for I ² C control bus. For SPI operation: SPI slave-select pin. |
| 27 | IOVDD | Digital supply | Digital I/O power supply (1.8 V or 3.3 V, nominal) |
| 28 | GPIO1 | Digital I/O | General-purpose digital input/output 1 (multipurpose functions such as daisy-chain input, audio data output, PLL input clock source, interrupt, and so forth) |
| 29 | SDOUT | Digital output | Audio serial data interface bus output |
| 30 | BCLK | Digital I/O | Audio serial data interface bus bit clock |
| 31 | FSYNC | Digital I/O | Audio serial data interface bus frame synchronization signal |
| 32 | DREG | Digital supply | Digital regulator output voltage for digital core supply (1.5 V, nominal) |
| Thermal Pad (VSS) | | Ground supply | Thermal pad shorted to the internal device ground. Short the thermal pad directly to the board ground plane. |

7 Specifications

7.1 Absolute Maximum Ratings

over the operating ambient temperature range (unless otherwise noted)⁽¹⁾

| | | MIN | MAX | UNIT |
|----------------------------|---|------|-------------|------|
| Supply voltage | AVDD to AVSS | -0.3 | 3.9 | V |
| | BSTVDD to VSS (thermal pad) | -0.3 | 3.9 | |
| | IOVDD to VSS (thermal pad) | -0.3 | 3.9 | |
| Ground voltage differences | AVSS to VSS (thermal pad) | -0.3 | 0.3 | V |
| Battery voltage | VBAT_IN to AVSS | -0.3 | 18 | V |
| Analog input voltage | Analog input pins voltage to AVSS | -0.3 | 18 | V |
| Digital input voltage | Digital input pins voltage to VSS (thermal pad) | -0.3 | IOVDD + 0.3 | V |
| Temperature | Operating ambient, T _A | -40 | 125 | °C |
| | Junction, T _J | -40 | 150 | |
| | Storage, T _{stg} | -65 | 150 | |

(1) Stresses beyond those listed under *Absolute Maximum Ratings* may cause permanent damage to the device. These are stress ratings only, which do not imply functional operation of the device at these or any other conditions beyond those indicated under *Recommended Operating Conditions*. Exposure to absolute-maximum-rated conditions for extended periods may affect device reliability.

7.2 ESD Ratings

| | | | VALUE | UNIT | |
|--------------------|-------------------------|---|-----------------------------------|------|------|
| V _(ESD) | Electrostatic discharge | Human-body model (HBM), per AEC Q100-002 ⁽¹⁾ | ±2000 | V | |
| | | Charged-device model (CDM), per AEC Q100-011 | Corner package pins | | ±750 |
| | | | All other non-corner package pins | | ±500 |

(1) AEC Q100-002 indicates that HBM stressing shall be in accordance with the ANSI/ESDA/JEDEC JS-001 specification.

7.3 Recommended Operating Conditions

| | | MIN | NOM | MAX | UNIT |
|---------------------|--|------|------|---------------|------|
| POWER | | | | | |
| AVDD ⁽¹⁾ | Analog supply voltage to AVSS | 3.0 | 3.3 | 3.6 | V |
| BSTVDD | Boost converter supply voltage to VSS (thermal pad) | 3.0 | 3.3 | 3.6 | V |
| IOVDD | IO supply voltage to VSS (thermal pad) - IOVDD 3.3-V operation | 3.0 | 3.3 | 3.6 | V |
| | IO supply voltage to VSS (thermal pad) - IOVDD 1.8-V operation | 1.65 | 1.8 | 1.95 | |
| INPUTS | | | | | |
| VBAT_IN | VBAT_IN input pin voltage to AVSS | 0 | 12.6 | 18 | V |
| INxx | Analog input pins voltage to AVSS for line-in recording | 0 | | 14.2 | V |
| | Analog input pins voltage to AVSS for microphone recording | 0.1 | | MICBIAS – 0.1 | V |
| | Analog input pins voltage to AVSS during short to VBAT_IN | | | VBAT_IN | V |
| | Digital input pins voltage to VSS (thermal pad) | 0 | | IOVDD | V |
| TEMPERATURE | | | | | |
| T _A | Operating ambient temperature | -40 | | 125 | °C |

7.3 Recommended Operating Conditions (continued)

| | | MIN | NOM | MAX | UNIT |
|----------------|---|-----|-----|-----------------------|------|
| OTHERS | | | | | |
| | GPIOx or GPIx (used as MCLK input) clock frequency | | | 36.864 ⁽²⁾ | MHz |
| C _b | SCL and SDA bus capacitance for I ² C interface supports standard-mode and fast-mode | | | 400 | pF |
| | SCL and SDA bus capacitance for I ² C interface supports fast-mode plus | | | 550 | |
| C _L | Digital output load capacitance | | 20 | 50 | pF |
| | Boost converter inductor for 6MHz clocking mode (recommended inductor CIGW201610GL2R2MLE) | | 2.2 | | μH |

- (1) AVSS and VSS (thermal pad); all ground pins must be tied together and must not differ in voltage by more than 0.2 V.
 (2) MCLK input rise time (V_{IL} to V_{IH}) and fall time (V_{IH} to V_{IL}) must be less than 5 ns. For better audio noise performance, MCLK input must be used with low jitter.

7.4 Thermal Information

| THERMAL METRIC ⁽¹⁾ | | PCM6480-Q1 | | UNIT |
|-------------------------------|--|------------|--|------|
| | | RTV (WQFN) | | |
| | | 32 PINS | | |
| R _{θJA} | Junction-to-ambient thermal resistance | 30.1 | | °C/W |
| R _{θJC(top)} | Junction-to-case (top) thermal resistance | 17.0 | | °C/W |
| R _{θJB} | Junction-to-board thermal resistance | 11.0 | | °C/W |
| ψ _{JT} | Junction-to-top characterization parameter | 0.2 | | °C/W |
| ψ _{JB} | Junction-to-board characterization parameter | 10.9 | | °C/W |
| R _{θJC(bot)} | Junction-to-case (bottom) thermal resistance | 1.8 | | °C/W |

- (1) For more information about traditional and new thermal metrics, see the [Semiconductor and IC Package Thermal Metrics](#) application report.

7.5 Electrical Characteristics

at T_A = 25°C, AVDD = 3.3 V, IOVDD = 3.3 V, BSTVDD = 3.3 V, f_{IN} = 1-kHz sinusoidal signal, f_S = 48 kHz, 32-bit audio data, BCLK = 256 × f_S, TDM slave mode and PLL on (unless otherwise noted)

| PARAMETER | TEST CONDITIONS | MIN | NOM | MAX | UNIT |
|---|--|-----|-----|------------------|------|
| ADC PERFORMANCE FOR LINE INPUT RECORDING | | | | | |
| Differential input full-scale AC signal voltage | AC-coupled input, input fault diagnostic not supported | 10 | | V _{RMS} | |
| | DC-coupled input, DC common-mode voltage INxP = INxM = 7.1 V, input fault diagnostic not supported | | | | |
| Single-ended input full-scale AC signal voltage | AC-coupled input, input fault diagnostic not supported | 5 | | V _{RMS} | |
| | DC-coupled input, DC common-mode voltage INxP = INxM = 7.1 V, input fault diagnostic not supported | | | | |
| SNR | IN1 differential AC-coupled input selected and AC signal shorted to ground, 0-dB channel gain | 105 | 110 | dB | |
| | IN1 differential DC-coupled input selected and AC signal shorted to ground, 0-dB channel gain | 110 | | | |
| | IN1 differential DC-coupled input selected and AC signal shorted to ground, 12-dB channel gain | 101 | | | |

7.5 Electrical Characteristics (continued)

at $T_A = 25^\circ\text{C}$, $AVDD = 3.3\text{ V}$, $IOVDD = 3.3\text{ V}$, $BSTVDD = 3.3\text{ V}$, $f_{IN} = 1\text{-kHz}$ sinusoidal signal, $f_S = 48\text{ kHz}$, 32-bit audio data, $BCLK = 256 \times f_S$, TDM slave mode and PLL on (unless otherwise noted)

| PARAMETER | | TEST CONDITIONS | MIN | NOM | MAX | UNIT |
|---|--|---|------|-----|-----|------------|
| DR | Dynamic range, A-weighted ⁽²⁾ | IN1 differential AC-coupled input selected and –60-dB full-scale AC signal input, 0-dB channel gain | | 110 | | dB |
| | | IN1 differential DC-coupled input selected and –60-dB full-scale AC signal input, 0-dB channel gain | | 110 | | |
| | | IN1 differential DC-coupled input selected and –72-dB full-scale AC signal input, 12-dB channel gain | | 101 | | |
| THD+N | Total harmonic distortion ⁽²⁾ | IN1 differential AC-coupled input selected and –1-dB full-scale AC signal input, 0-dB channel gain | | –95 | –78 | dB |
| | | IN1 differential DC-coupled input selected and –1-dB full-scale AC signal input, 0-dB channel gain | | –95 | | |
| | | IN1 differential DC-coupled input selected and –13-dB full-scale AC signal input, 12-dB channel gain | | –91 | | |
| | Channel gain control range | Programmable 1-dB steps | 0 | | 42 | dB |
| ADC PERFORMANCE FOR MICROPHONE INPUT RECORDING | | | | | | |
| | Differential input full-scale AC signal voltage ⁽³⁾ | AC-coupled input, input fault diagnostic not supported. CHx_MIC_RANGE register bit is set to high. DC-coupled input, DC differential common-mode voltage $INxP - INxM > 3.4\text{ V}$, DC common-mode voltage $INxP < (\text{MICBIAS} - 1.7\text{ V})$ and DC common-mode voltage $INxM > 1.7\text{ V}$. CHx_MIC_RANGE register bit is set to high to support AC differential signal max swing $> 2 V_{rms}^{(4)}$. | | 10 | | V_{RMS} |
| SNR | Signal-to-noise ratio, A-weighted ^{(1) (2)} | IN1 differential AC-coupled input selected and AC signal shorted to ground, 0-dB channel gain | | 110 | | dB |
| | | IN1 differential DC-coupled input selected and AC-signal shorted to ground, DC differential common-mode voltage $IN1P - IN1M < 5.0\text{ V}$, 0-dB channel gain | 105 | 110 | | |
| DR | Dynamic range, A-weighted ⁽²⁾ | IN1 differential AC-coupled input selected and –60-dB full-scale AC signal input, 0-dB channel gain | | 110 | | dB |
| | | IN1 differential DC-coupled input selected and –60-dB full-scale AC signal input, DC differential common-mode voltage $IN1P - IN1M < 5.0\text{ V}$, 0-dB channel gain | | 110 | | |
| THD+N | Total harmonic distortion ⁽²⁾ | IN1 differential AC-coupled input selected and –1-dB full-scale AC signal input, 0-dB channel gain | | –92 | | dB |
| | | IN1 differential DC-coupled input selected and –15-dB full-scale AC signal input, 0-dB channel gain | | –90 | –78 | |
| | Channel gain control range | Programmable 1-dB steps | 0 | | 42 | dB |
| ADC OTHER PARAMETERS | | | | | | |
| | Input impedance | Differential input, between $INxP$ and $INxM$ | | 50 | | k Ω |
| | | Single-ended input, between $INxP$ and $INxM$ | | 25 | | |
| | Digital volume control range | Programmable 0.5-dB steps | –100 | | 27 | dB |

7.5 Electrical Characteristics (continued)

at $T_A = 25^\circ\text{C}$, $AVDD = 3.3\text{ V}$, $IOVDD = 3.3\text{ V}$, $BSTVDD = 3.3\text{ V}$, $f_{IN} = 1\text{-kHz}$ sinusoidal signal, $f_S = 48\text{ kHz}$, 32-bit audio data, $BCLK = 256 \times f_S$, TDM slave mode and PLL on (unless otherwise noted)

| PARAMETER | | TEST CONDITIONS | MIN | NOM | MAX | UNIT |
|--------------------------|---|---|----------------------------|------|----------------------------|----------------------------|
| | Output data sample rate | Programmable | 7.35 | | 768 | kHz |
| | Output data sample word length | Programmable | 16 | | 32 | Bits |
| | Digital high-pass filter cutoff frequency | First-order IIR filter with programmable coefficients, -3-dB point (default setting) | | 12 | | Hz |
| | Interchannel isolation | -1-dB full-scale AC signal line-in input to non measurement channel | | -134 | | dB |
| | Interchannel gain mismatch | -6-dB full-scale AC signal line-in input, 0-dB channel gain | | 0.1 | | dB |
| | Interchannel phase mismatch | 1-kHz sinusoidal signal | | 0.01 | | Degrees |
| PSRR | Power-supply rejection ratio | 100-mV _{PP} , 1-kHz sinusoidal signal on AVDD, differential input selected, 0-dB channel gain | | 92 | | dB |
| CMRR | Common-mode rejection ratio | Differential microphone input selected, 0-dB channel gain, 1-V _{RMS} AC input, 1-kHz signal on both pins and measure level at output, CHx_CFG0 D3-2 register bits set to 2b'10 to configure device in high CMRR performance mode | | 70 | | dB |
| MICROPHONE BIAS | | | | | | |
| | MICBIAS noise | BW = 20 Hz to 20 kHz, A-weighted, 1- μF capacitor between MICBIAS and AVSS | | 6.8 | | μV_{RMS} |
| | MICBIAS voltage | Programmable 0.5-V steps | 5 | | 9 | V |
| | MICBIAS current drive | MICBIAS voltage 9 V | | | 80 | mA |
| | MICBIAS load regulation | MICBIAS voltage 9 V, measured up to maximum load | 0 | | 1 | % |
| | MICBIAS over current protection threshold | MICBIAS voltage 9 V | 82 | | | mA |
| INPUT DIAGNOSTICS | | | | | | |
| | Fault monitoring repetition rate | Programmable, DC-coupled input | 1 | 4 | 8 | ms |
| | Fault response time | Fault monitoring repetition rate 4-ms, DC-coupled input | | 16 | | ms |
| | Threshold voltage for (INxx – AVSS) input shorted to ground | Programmable 60-mV steps, DC-coupled input | 0 | | 900 | mV |
| | Threshold voltage for (INxP – INxM) input shorted together | Programmable 30-mV steps, DC-coupled input | 0 | | 450 | mV |
| | Threshold voltage for (MICBIAS – INxx) input shorted to MICBIAS | Programmable 30-mV steps, DC-coupled input | 0 | | 450 | mV |
| | Threshold voltage for (VBAT – INxx) input shorted to VBAT_IN | Programmable 30-mV steps, DC-coupled input | 0 | | 450 | mV |
| DIGITAL I/O | | | | | | |
| $V_{IL(\text{SHDNZ})}$ | Low-level digital input logic voltage threshold | SHDNZ pin | -0.3 | | $0.25 \times \text{IOVDD}$ | V |
| $V_{IH(\text{SHDNZ})}$ | High-level digital input logic voltage threshold | SHDNZ pin | $0.75 \times \text{IOVDD}$ | | $\text{IOVDD} + 0.3$ | V |

7.5 Electrical Characteristics (continued)

at $T_A = 25^\circ\text{C}$, $AVDD = 3.3\text{ V}$, $IOVDD = 3.3\text{ V}$, $BSTVDD = 3.3\text{ V}$, $f_{IN} = 1\text{-kHz}$ sinusoidal signal, $f_S = 48\text{ kHz}$, 32-bit audio data, $BCLK = 256 \times f_S$, TDM slave mode and PLL on (unless otherwise noted)

| PARAMETER | | TEST CONDITIONS | MIN | NOM | MAX | UNIT |
|----------------|---|--|----------------------------|-----|----------------------------|---------------|
| V_{IL} | Low-level digital input logic voltage threshold | All digital pins except SDA and SCL, IOVDD 1.8-V operation | -0.3 | | $0.35 \times \text{IOVDD}$ | V |
| | | All digital pins except SDA and SCL, IOVDD 3.3-V operation | -0.3 | | 0.8 | |
| V_{IH} | High-level digital input logic voltage threshold | All digital pins except SDA and SCL, IOVDD 1.8-V operation | $0.65 \times \text{IOVDD}$ | | $\text{IOVDD} + 0.3$ | V |
| | | All digital pins except SDA and SCL, IOVDD 3.3-V operation | 2 | | $\text{IOVDD} + 0.3$ | |
| V_{OL} | Low-level digital output voltage | All digital pins except SDA and SCL, $I_{OL} = -2\text{ mA}$, IOVDD 1.8-V operation | | | 0.45 | V |
| | | All digital pins except SDA and SCL, $I_{OL} = -2\text{ mA}$, IOVDD 3.3-V operation | | | 0.4 | |
| V_{OH} | High-level digital output voltage | All digital pins except SDA and SCL, $I_{OH} = 2\text{ mA}$, IOVDD 1.8-V operation | $\text{IOVDD} - 0.45$ | | | V |
| | | All digital pins except SDA and SCL, $I_{OH} = 2\text{ mA}$, IOVDD 3.3-V operation | 2.4 | | | |
| $V_{IL(I2C)}$ | Low-level digital input logic voltage threshold | SDA and SCL | -0.5 | | $0.3 \times \text{IOVDD}$ | V |
| $V_{IH(I2C)}$ | High-level digital input logic voltage threshold | SDA and SCL | $0.7 \times \text{IOVDD}$ | | $\text{IOVDD} + 0.5$ | V |
| $V_{OL1(I2C)}$ | Low-level digital output voltage | SDA, $I_{OL(I2C)} = -3\text{ mA}$, $\text{IOVDD} > 2\text{ V}$ | | | 0.4 | V |
| $V_{OL2(I2C)}$ | Low-level digital output voltage | SDA, $I_{OL(I2C)} = -2\text{ mA}$, $\text{IOVDD} \leq 2\text{ V}$ | | | $0.2 \times \text{IOVDD}$ | V |
| $I_{OL(I2C)}$ | Low-level digital output current | SDA, $V_{OL(I2C)} = 0.4\text{ V}$, standard-mode or fast-mode | 3 | | | mA |
| | | SDA, $V_{OL(I2C)} = 0.4\text{ V}$, fast-mode plus | 20 | | | |
| I_{IL} | Input logic-low leakage for digital inputs | All digital pins, input = 0 V | -5 | 0.1 | 5 | μA |
| I_{IH} | Input logic-high leakage for digital inputs | All digital pins, input = IOVDD | -5 | 0.1 | 5 | μA |
| C_{IN} | Input capacitance for digital inputs | All digital pins | | 5 | | pF |
| R_{PD} | Pulldown resistance for digital I/O pins when asserted on | | | 20 | | k Ω |

TYPICAL SUPPLY CURRENT CONSUMPTION

| | | | | | |
|--------------|--|---|--|-------|---------------|
| I_{AVDD} | Current consumption in hardware shutdown mode | SHDNZ = 0, all device external clocks stopped | | 0.5 | μA |
| I_{BSTVDD} | | | | 0.1 | |
| I_{IOVDD} | | | | 0.1 | |
| I_{AVDD} | Current consumption in sleep mode (software shutdown mode) | All device external clocks stopped | | 4 | μA |
| I_{BSTVDD} | | | | 0.1 | |
| I_{IOVDD} | | | | 0.1 | |
| I_{AVDD} | Current consumption when MICBIAS ON, MICBIAS voltage 9 V, 40 mA load, ADC off | $f_S = 48\text{ kHz}$, $BCLK = 256 \times f_S$ | | 2.1 | mA |
| I_{BSTVDD} | | | | 162.5 | |
| I_{IOVDD} | | | | 0.01 | |
| I_{AVDD} | Current consumption with ADC 2-channel analog input operation at $f_S 16\text{-kHz}$ | MICBIAS off, PLL on, $BCLK = 512 \times f_S$ | | 13.5 | mA |
| I_{BSTVDD} | | | | 0 | |
| I_{IOVDD} | | | | 0.1 | |

7.5 Electrical Characteristics (continued)

at $T_A = 25^\circ\text{C}$, $AVDD = 3.3\text{ V}$, $IOVDD = 3.3\text{ V}$, $BSTVDD = 3.3\text{ V}$, $f_{IN} = 1\text{-kHz}$ sinusoidal signal, $f_S = 48\text{ kHz}$, 32-bit audio data, $BCLK = 256 \times f_S$, TDM slave mode and PLL on (unless otherwise noted)

| PARAMETER | | TEST CONDITIONS | MIN | NOM | MAX | UNIT |
|--------------|---|---|-----|------|-----|------|
| I_{AVDD} | Current consumption with ADC 2-channel analog input operation at f_S 48-kHz | MICBIAS off, PLL off, $BCLK = 512 \times f_S$ | | 13.5 | | mA |
| I_{BSTVDD} | | | | 0 | | |
| I_{IOVDD} | | | | 0.1 | | |
| I_{AVDD} | Current consumption with ADC 4-channel analog input operation at f_S 48-kHz | MICBIAS off, PLL on, $BCLK = 256 \times f_S$ | | 24.7 | | mA |
| I_{BSTVDD} | | | | 0 | | |
| I_{IOVDD} | | | | 0.2 | | |
| I_{AVDD} | Current consumption with 4-channel digital PDM input operation at f_S 48 kHz | MICBIAS off, PLL on, $BCLK = 256 \times f_S$, GPIO2 and GPIO3 configured as PDMCLK = $64 \times f_S$ | | 9.7 | | mA |
| I_{BSTVDD} | | | | 0 | | |
| I_{IOVDD} | | | | 3.1 | | |
| I_{AVDD} | Current consumption with ADC 4-channel analog input and 4-channel digital PDM input operation at f_S 48 kHz | MICBIAS off, PLL on, $BCLK = 256 \times f_S$, GPIO2 and GPIO3 configured as PDMCLK = $64 \times f_S$ | | 28.5 | | mA |
| I_{BSTVDD} | | | | 0 | | |
| I_{IOVDD} | | | | 3.2 | | |

- (1) Ratio of output level with 1-kHz full-scale sine-wave input, to the output level with the AC signal input shorted to ground, measured A-weighted over a 20-Hz to 20-kHz bandwidth using an audio analyzer.
- (2) All performance measurements done with 20-kHz low-pass filter and, where noted, A-weighted filter. Failure to use such a filter can result in higher THD and lower SNR and dynamic range readings than shown in the Electrical Characteristics. The low-pass filter removes out-of-band noise, which, although not audible, can affect dynamic specification values.
- (3) Microphone inputs support a $2 V_{RMS}$ differential input full-scale AC signal voltage, if the CHx_MIC_RANGE register bit is set to low (default value). However, if the input DC common-mode differential voltage is higher than 4 V, then TI recommends setting the CHx_MIC_RANGE register bit high to avoid any saturation resulting from the high input DC common-mode differential voltage.
- (4) If the CHx_MIC_RANGE register bit is set to high (default value is low) in DC-coupled input configuration mode, then the input differential DC common-mode along with input differential AC signal must be less than $10 V_{RMS}$ for differential input configuration mode. Similarly, for single-ended input configuration mode, the input DC common-mode voltage along with the input AC signal must be less than $5 V_{RMS}$.

7.6 Timing Requirements: I²C Interface

at $T_A = 25^\circ\text{C}$, $IOVDD = 3.3\text{ V}$ or 1.8 V (unless otherwise noted); see [Figure 7-1](#) for timing diagram

| | | MIN | NOM | MAX | UNIT |
|----------------------|--|-----|-----|------|---------------|
| STANDARD-MODE | | | | | |
| f_{SCL} | SCL clock frequency | 0 | | 100 | kHz |
| $t_{HD;STA}$ | Hold time (repeated) START condition. After this period, the first clock pulse is generated. | 4 | | | μs |
| t_{LOW} | Low period of the SCL clock | 4.7 | | | μs |
| t_{HIGH} | High period of the SCL clock | 4 | | | μs |
| $t_{SU;STA}$ | Setup time for a repeated START condition | 4.7 | | | μs |
| $t_{HD;DAT}$ | Data hold time | 0 | | 3.45 | μs |
| $t_{SU;DAT}$ | Data setup time | 250 | | | ns |
| t_r | SDA and SCL rise time | | | 1000 | ns |
| t_f | SDA and SCL fall time | | | 300 | ns |
| $t_{SU;STO}$ | Setup time for STOP condition | 4 | | | μs |
| t_{BUF} | Bus free time between a STOP and START condition | 4.7 | | | μs |
| FAST-MODE | | | | | |
| f_{SCL} | SCL clock frequency | 0 | | 400 | kHz |
| $t_{HD;STA}$ | Hold time (repeated) START condition. After this period, the first clock pulse is generated. | 0.6 | | | μs |

7.6 Timing Requirements: I²C Interface (continued)

at T_A = 25°C, IOVDD = 3.3 V or 1.8 V (unless otherwise noted); see [Figure 7-1](#) for timing diagram

| | | MIN | NOM | MAX | UNIT |
|-----------------------|--|----------------------------|-----|------|------|
| t _{LOW} | Low period of the SCL clock | 1.3 | | | μs |
| t _{HIGH} | High period of the SCL clock | 0.6 | | | μs |
| t _{SU,STA} | Setup time for a repeated START condition | 0.6 | | | μs |
| t _{HD,DAT} | Data hold time | 0 | | 0.9 | μs |
| t _{SU,DAT} | Data setup time | 100 | | | ns |
| t _r | SDA and SCL rise time | 20 | | 300 | ns |
| t _f | SDA and SCL fall time | 20 × (IOVDD / 5.5 V) | | 300 | ns |
| t _{SU,STO} | Setup time for STOP condition | 0.6 | | | μs |
| t _{BUF} | Bus free time between a STOP and START condition | 1.3 | | | μs |
| FAST-MODE PLUS | | | | | |
| f _{SCL} | SCL clock frequency | 0 | | 1000 | kHz |
| t _{HD,STA} | Hold time (repeated) START condition. After this period, the first clock pulse is generated. | 0.26 | | | μs |
| t _{LOW} | Low period of the SCL clock | 0.5 | | | μs |
| t _{HIGH} | High period of the SCL clock | 0.26 | | | μs |
| t _{SU,STA} | Setup time for a repeated START condition | 0.26 | | | μs |
| t _{HD,DAT} | Data hold time | 0 | | | μs |
| t _{SU,DAT} | Data setup time | 50 | | | ns |
| t _r | SDA and SCL Rise Time | | | 120 | ns |
| t _f | SDA and SCL Fall Time | 20 × (IOVDD / 5.5 V) | | 120 | ns |
| t _{SU,STO} | Setup time for STOP condition | 0.26 | | | μs |
| t _{BUF} | Bus free time between a STOP and START condition | 0.5 | | | μs |

7.7 Switching Characteristics: I²C Interface

at T_A = 25°C, IOVDD = 3.3 V or 1.8 V (unless otherwise noted); see [Figure 7-1](#) for timing diagram

| PARAMETER | TEST CONDITIONS | MIN | TYP | MAX | UNIT |
|---------------------|-----------------|-----|-----|------|------|
| t _{d(SDA)} | Standard-mode | 200 | | 1250 | ns |
| | Fast-mode | 200 | | 850 | ns |
| | Fast-mode plus | | | 400 | ns |

7.8 Timing Requirements: SPI Interface

at $T_A = 25^\circ\text{C}$, IOVDD = 3.3 V or 1.8 V and 20-pF load on all outputs (unless otherwise noted); see [Figure 7-2](#) for timing diagram

| | | MIN | NOM | MAX | UNIT |
|-----------------|---------------------------|---------------------|-----|-----|------|
| $t_{(SCLK)}$ | SCLK period | 40 | | | ns |
| $t_{H(SCLK)}$ | SCLK high pulse duration | 18 | | | ns |
| $t_{L(SCLK)}$ | SCLK low pulse duration | 18 | | | ns |
| t_{LEAD} | Enable lead time | 16 | | | ns |
| t_{TRAIL} | Enable trail time | 16 | | | ns |
| t_{DSEQ} | Sequential transfer delay | 20 | | | ns |
| $t_{SU(MOSI)}$ | MOSI data setup time | 8 | | | ns |
| $t_{HLD(MOSI)}$ | MOSI data hold time | 8 | | | ns |
| $t_{r(SCLK)}$ | SCLK rise time | 10% - 90% rise time | | 6 | ns |
| $t_{f(SCLK)}$ | SCLK fall time | 90% - 10% fall time | | 6 | ns |

7.9 Switching Characteristics: SPI Interface

at $T_A = 25^\circ\text{C}$, IOVDD = 3.3 V or 1.8 V and 20-pF load on all outputs (unless otherwise noted); see [Figure 7-2](#) for timing diagram

| PARAMETER | | TEST CONDITIONS | MIN | TYP | MAX | UNIT |
|------------------------|--------------------|---|-----|-----|-----|------|
| $t_a(\text{MISO})$ | MISO access time | IOVDD = 1.8 V | | | 18 | ns |
| | | IOVDD = 3.3 V | | | 14 | |
| $t_d(\text{MISO})$ | SCLK to MISO delay | 50% of SCLK to 50% of MISO, IOVDD = 1.8 V | | | 19 | ns |
| | | 50% of SCLK to 50% of MISO, IOVDD = 3.3 V | | | 15 | |
| $t_{dis}(\text{MISO})$ | MISO disable time | IOVDD = 1.8 V | | | 18 | ns |
| | | IOVDD = 3.3 V | | | 14 | |

7.10 Timing Requirements: TDM, I²S or LJ Interface

at $T_A = 25^\circ\text{C}$, IOVDD = 3.3 V or 1.8 V and 20-pF load on all outputs (unless otherwise noted); see [Figure 7-3](#) for timing diagram

| | | MIN | NOM | MAX | UNIT |
|------------------|---|---------------------|-----|-----|------|
| $t_{(BCLK)}$ | BCLK period | 40 | | | ns |
| $t_{H(BCLK)}$ | BCLK high pulse duration ⁽¹⁾ | 18 | | | ns |
| $t_{L(BCLK)}$ | BCLK low pulse duration ⁽¹⁾ | 18 | | | ns |
| $t_{SU(FSYNC)}$ | FSYNC setup time | 8 | | | ns |
| $t_{HLD(FSYNC)}$ | FSYNC hold time | 8 | | | ns |
| $t_{r(BCLK)}$ | BCLK rise time | 10% - 90% rise time | | 10 | ns |
| $t_{f(BCLK)}$ | BCLK fall time | 90% - 10% fall time | | 10 | ns |

- (1) The BCLK minimum high or low pulse duration must be higher than 25 ns (to meet the timing specifications), if the SDOUT data line is latched on the opposite BCLK edge polarity than the edge used by the device to transmit SDOUT data.

7.11 Switching Characteristics: TDM, I²S or LJ Interface

at $T_A = 25^\circ\text{C}$, IOVDD = 3.3 V or 1.8 V and 20-pF load on all outputs (unless otherwise noted); see [Figure 7-3](#) for timing diagram

| PARAMETER | | TEST CONDITIONS | MIN | TYP | MAX | UNIT |
|-----------------------------|--|---|-----|-----|--------|------|
| $t_{d(\text{SDOUT-BCLK})}$ | BCLK to SDOUT delay | 50% of BCLK to 50% of SDOUT, IOVDD = 1.8 V | | | 18 | ns |
| | | 50% of BCLK to 50% of SDOUT, IOVDD = 3.3 V | | | 14 | |
| $t_{d(\text{SDOUT-FSYNC})}$ | FSYNC to SDOUT delay in TDM or LJ mode (for MSB data with TX_OFFSET = 0) | 50% of FSYNC to 50% of SDOUT, IOVDD = 1.8 V | | | 18 | ns |
| | | 50% of FSYNC to 50% of SDOUT, IOVDD = 3.3 V | | | 14 | |
| $f_{(\text{BCLK})}$ | BCLK output clock frequency; master mode ⁽¹⁾ | | | | 24.576 | MHz |
| $t_{H(\text{BCLK})}$ | BCLK high pulse duration; master mode | IOVDD = 1.8 V | 14 | | | ns |
| | | IOVDD = 3.3 V | 14 | | | |
| $t_{L(\text{BCLK})}$ | BCLK low pulse duration; master mode | IOVDD = 1.8 V | 14 | | | ns |
| | | IOVDD = 3.3 V | 14 | | | |
| $t_{d(\text{FSYNC})}$ | BCLK to FSYNC delay; master mode | 50% of BCLK to 50% of FSYNC, IOVDD = 1.8 V | | | 18 | ns |
| | | 50% of BCLK to 50% of FSYNC, IOVDD = 3.3 V | | | 14 | |
| $t_{r(\text{BCLK})}$ | BCLK rise time; master mode | 10% - 90% rise time, IOVDD = 1.8 V | | | 10 | ns |
| | | 10% - 90% rise time, IOVDD = 3.3 V | | | 10 | |
| $t_{f(\text{BCLK})}$ | BCLK fall time; master mode | 90% - 10% fall time, IOVDD = 1.8 V | | | 8 | ns |
| | | 90% - 10% fall time, IOVDD = 3.3 V | | | 8 | |

(1) The BCLK output clock frequency must be lower than 18.5 MHz (to meet the timing specifications), if the SDOUT data line is latched on the opposite BCLK edge polarity than the edge used by the device to transmit SDOUT data.

7.12 Timing Requirements: PDM Digital Microphone Interface

at $T_A = 25^\circ\text{C}$, IOVDD = 3.3 V or 1.8 V and 20-pF load on all outputs (unless otherwise noted); see [Figure 7-4](#) for timing diagram

| | | MIN | NOM | MAX | UNIT |
|----------------------------------|-------------------------|-----|-----|-----|------|
| $t_{\text{SU}}(\text{PDMDINx})$ | PDMDINx_GPIx setup time | 30 | | | ns |
| $t_{\text{HLD}}(\text{PDMDINx})$ | PDMDINx_GPIx hold time | 0 | | | ns |

7.13 Switching Characteristics: PDM Digital Microphone Interface

at $T_A = 25^\circ\text{C}$, IOVDD = 3.3 V or 1.8 V and 20-pF load on all outputs (unless otherwise noted); see Figure 7-4 for timing diagram

| PARAMETER | TEST CONDITIONS | MIN | TYP | MAX | UNIT |
|-----------------|-----------------------------------|---------------------|-----|-------|------|
| $f_{(PDMCLK)}$ | PDMCLKx_GPIOx clock frequency | 0.768 | | 6.144 | MHz |
| $t_{H(PDMCLK)}$ | PDMCLKx_GPIOx high pulse duration | 72 | | | ns |
| $t_{L(PDMCLK)}$ | PDMCLKx_GPIOx low pulse duration | 72 | | | ns |
| $t_r(PDMCLK)$ | PDMCLKx_GPIOx rise time | 10% - 90% rise time | | 18 | ns |
| $t_f(PDMCLK)$ | PDMCLKx_GPIOx fall time | 90% - 10% fall time | | 18 | ns |

7.14 Timing Diagrams

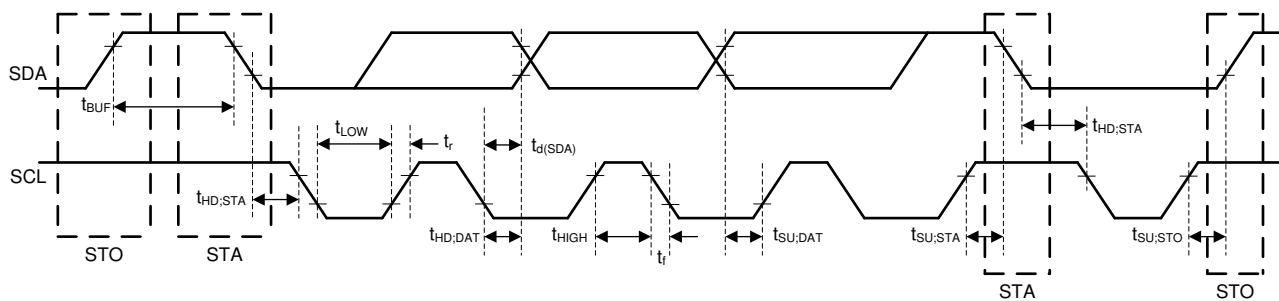

Figure 7-1. I²C Interface Timing Diagram

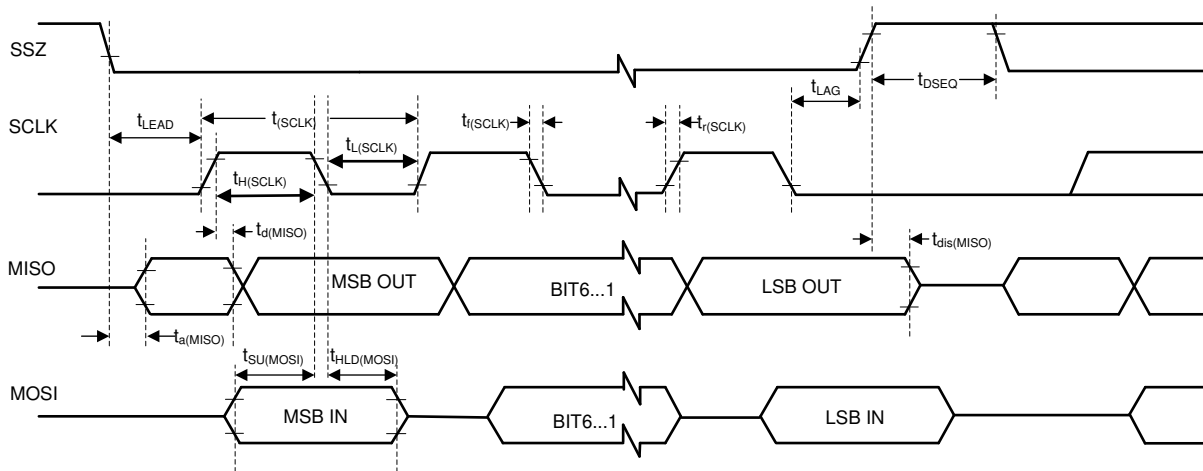

Figure 7-2. SPI Interface Timing Diagram

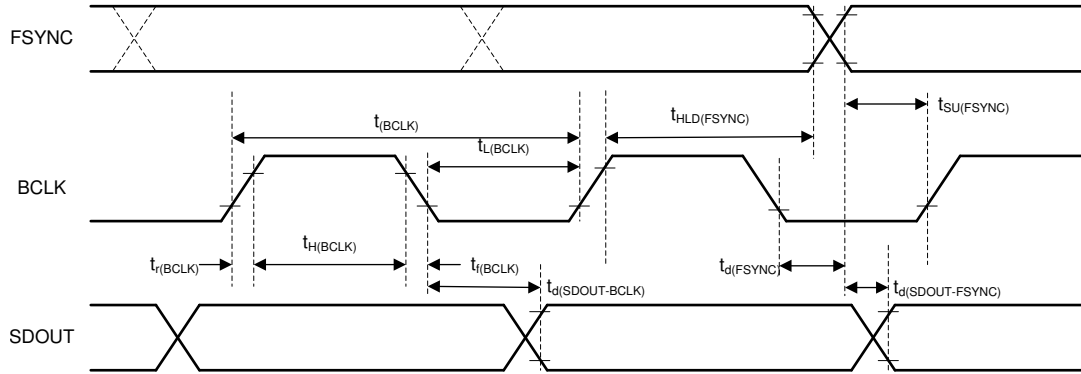

Figure 7-3. TDM, I²S, LJ Interface Timing Diagram

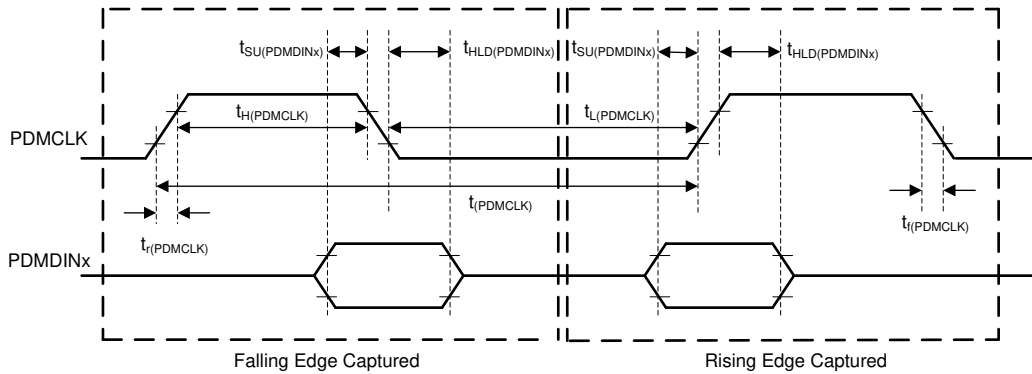
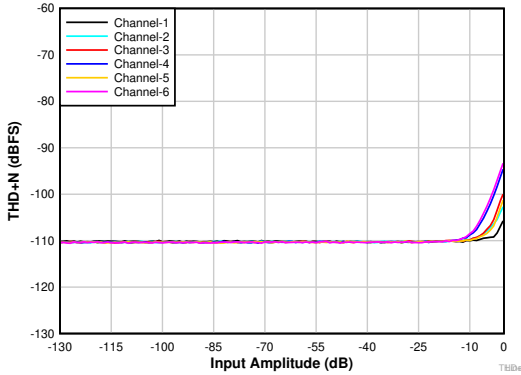

Figure 7-4. PDM Digital Microphone Interface Timing Diagram

7.15 Typical Characteristics

at $T_A = 25^\circ\text{C}$, $AVDD = 3.3\text{ V}$, $IOVDD = 3.3\text{ V}$, $BSTVDD = 3.3\text{ V}$, $f_{IN} = 1\text{-kHz}$ sinusoidal signal, $f_S = 48\text{ kHz}$, 32-bit audio data, $BCLK = 256 \times f_S$, TDM slave mode, PLL on, channel gain = 0 dB, linear phase decimation filter, and MICBIAS programmed voltage = 8 V (unless otherwise noted); all performance measurements are done by feeding the device analog input and PDM digital input signal using audio precision with a 20-kHz, low-pass filter and an A-weighted filter (unless otherwise noted)



AC-coupled differential line input

Figure 7-5. THD+N vs Input Amplitude

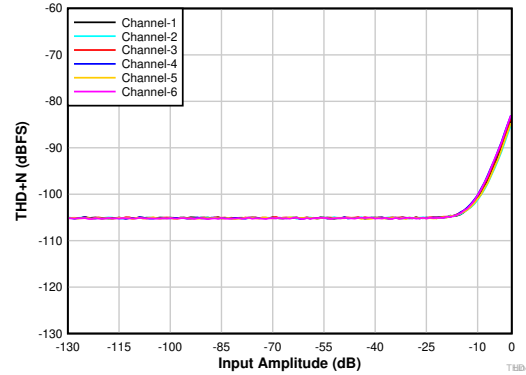

AC-coupled single-ended line input

Figure 7-6. THD+N vs Input Amplitude

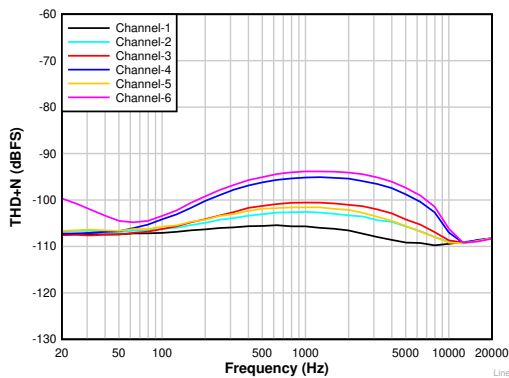

AC-coupled differential line input

Figure 7-7. THD+N vs Input Frequency With a -1-dBr Input (non A-weighted)

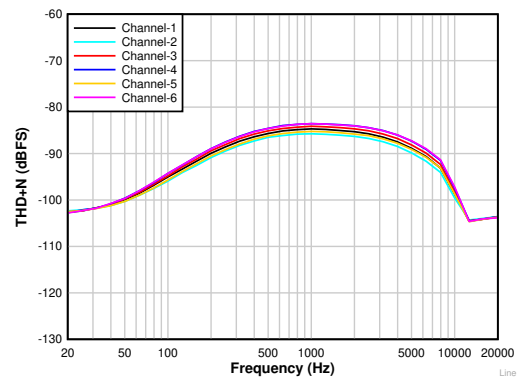

AC-coupled single-ended line input

Figure 7-8. THD+N vs Input Frequency With a -1-dBr Input (non A-weighted)

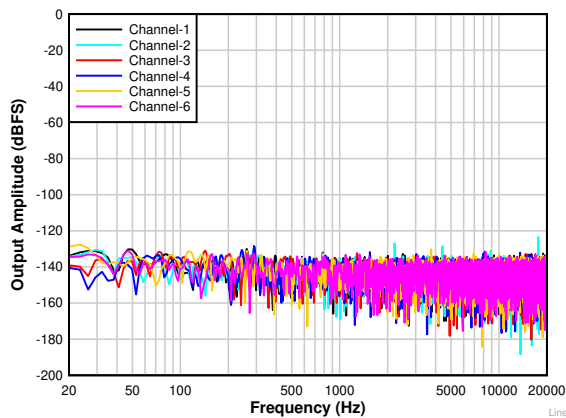

AC-coupled differential line input

Figure 7-9. FFT With Idle Input (non A-weighted)

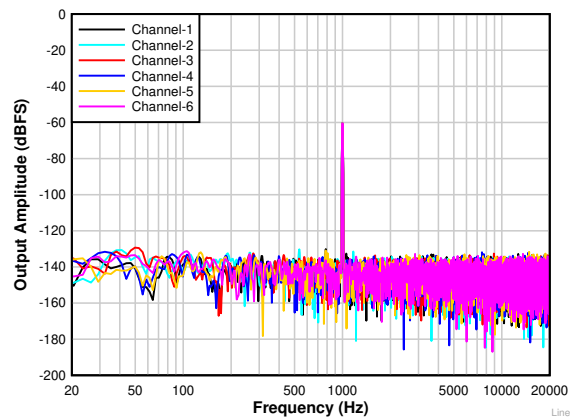

AC-coupled differential line input

Figure 7-10. FFT With a -60-dBr Input (non A-weighted)

7.15 Typical Characteristics (continued)

at $T_A = 25^\circ\text{C}$, $AVDD = 3.3\text{ V}$, $IOVDD = 3.3\text{ V}$, $BSTVDD = 3.3\text{ V}$, $f_{IN} = 1\text{-kHz}$ sinusoidal signal, $f_S = 48\text{ kHz}$, 32-bit audio data, $BCLK = 256 \times f_S$, TDM slave mode, PLL on, channel gain = 0 dB, linear phase decimation filter, and MICBIAS programmed voltage = 8 V (unless otherwise noted); all performance measurements are done by feeding the device analog input and PDM digital input signal using audio precision with a 20-kHz, low-pass filter and an A-weighted filter (unless otherwise noted)

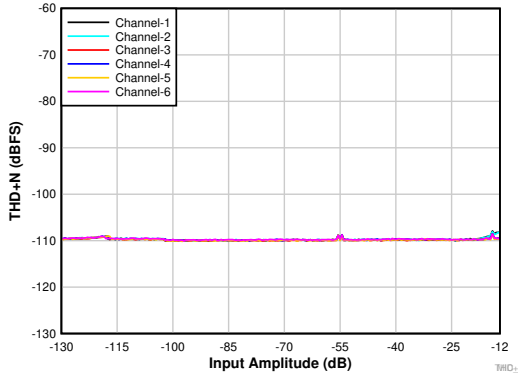

DC-coupled differential microphone input with DC common-mode $1N_{xP} = 6\text{ V}$ and $IN_{xM} = 2\text{ V}$, high swing mode enabled

Figure 7-11. THD+N vs Input Amplitude

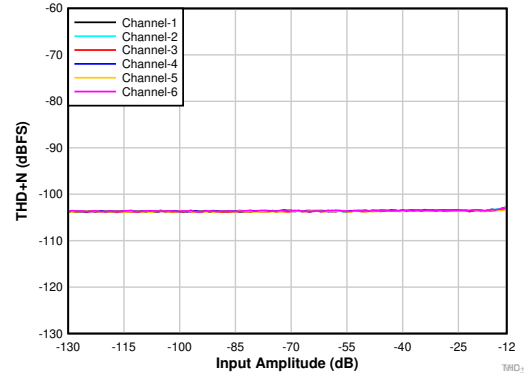

DC-coupled single-ended microphone input with DC common-mode $1N_{xP} = 4\text{ V}$ and $IN_{xM} = 0\text{ V}$, high swing mode enabled

Figure 7-12. THD+N vs Input Amplitude

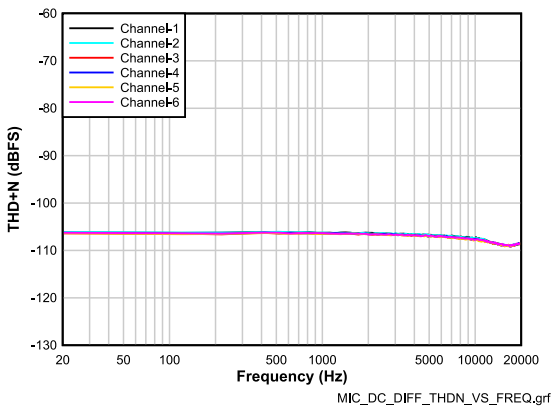

DC-coupled differential microphone input with DC common-mode $1N_{xP} = 6\text{ V}$ and $IN_{xM} = 2\text{ V}$, High swing mode enabled

Figure 7-13. THD+N vs Input Frequency With a -15-dBr Input (non A-weighted)

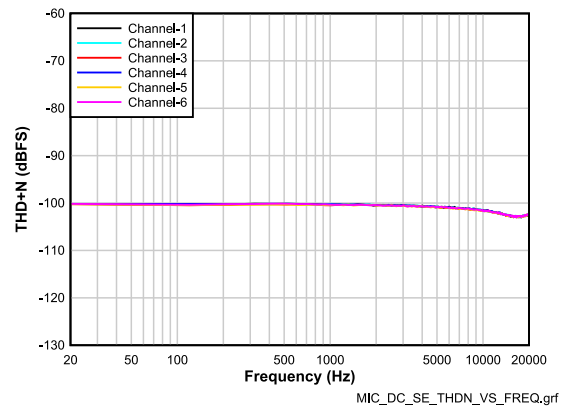

DC-coupled single-ended microphone input with DC common-mode $1N_{xP} = 4\text{ V}$ and $IN_{xM} = 0\text{ V}$, high swing mode enabled

Figure 7-14. THD+N vs Input Frequency With a -15-dBr Input (non A-weighted)

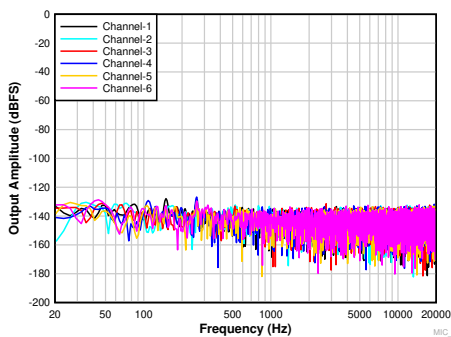

DC-coupled differential microphone input with DC common-mode $1N_{xP} = 6\text{ V}$ and $IN_{xM} = 2\text{ V}$, high swing mode enabled

Figure 7-15. FFT With Idle Input (non A-weighted)

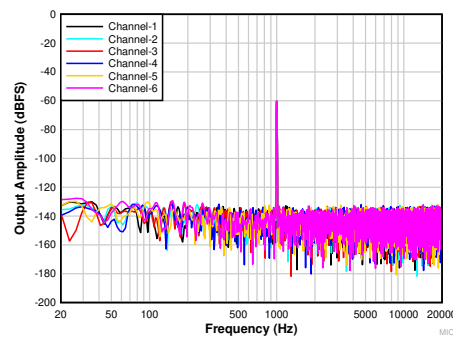

DC-coupled differential microphone input with DC common-mode $1N_{xP} = 6\text{ V}$ and $IN_{xM} = 2\text{ V}$, high swing mode enabled

Figure 7-16. FFT With a -60-dBr Input (non A-weighted)

7.15 Typical Characteristics (continued)

at $T_A = 25^\circ\text{C}$, $AVDD = 3.3\text{ V}$, $IOVDD = 3.3\text{ V}$, $BSTVDD = 3.3\text{ V}$, $f_{IN} = 1\text{-kHz}$ sinusoidal signal, $f_S = 48\text{ kHz}$, 32-bit audio data, $BCLK = 256 \times f_S$, TDM slave mode, PLL on, channel gain = 0 dB, linear phase decimation filter, and MICBIAS programmed voltage = 8 V (unless otherwise noted); all performance measurements are done by feeding the device analog input and PDM digital input signal using audio precision with a 20-kHz, low-pass filter and an A-weighted filter (unless otherwise noted)

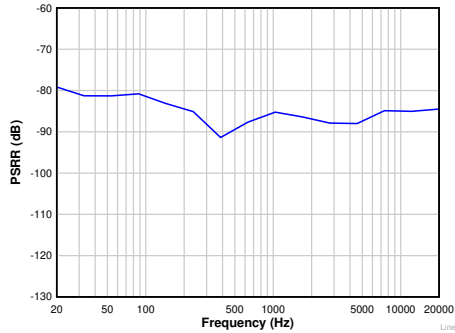

AC-coupled differential line input

Figure 7-17. Power-Supply Rejection Ratio vs Ripple Frequency With 1-V_{PP} Amplitude

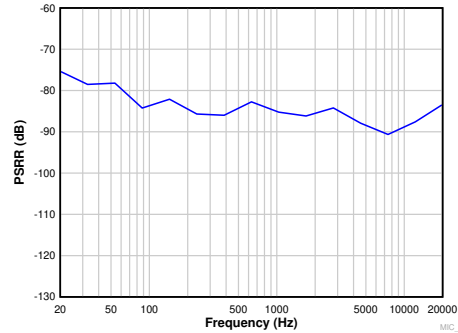

DC-coupled differential microphone input with DC common-mode $1N_{xP} = 6\text{ V}$ and $IN_{xM} = 2\text{ V}$, high swing mode enabled

Figure 7-18. Power-Supply Rejection Ratio vs Ripple Frequency With 1-V_{PP} Amplitude

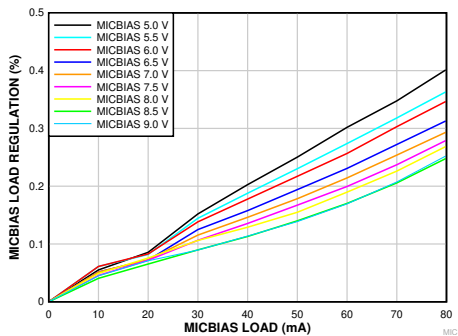

DC-coupled differential microphone input

Figure 7-19. MICBIAS Load Regulation vs MICBIAS Load Current

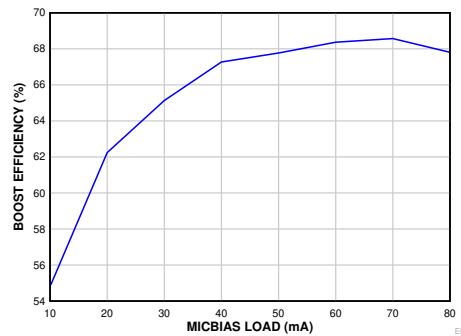

DC-coupled differential microphone input with DC common-mode $1N_{xP} = 6\text{ V}$ and $IN_{xM} = 2\text{ V}$, high swing mode enabled

Figure 7-20. Boost Efficiency vs MICBIAS Load Current

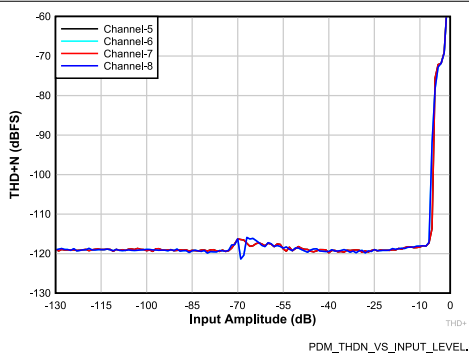

4th-order PDM modulator with $PDMCLKx = 3.072\text{ MHz}$

Figure 7-21. THD+N vs Input Amplitude

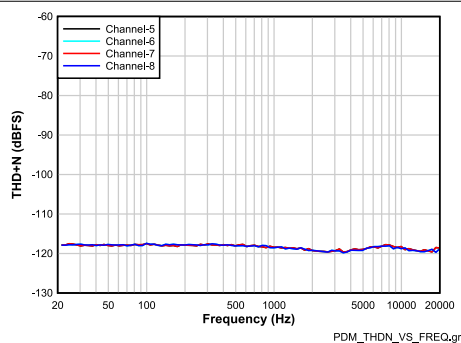

4th-order PDM modulator with $PDMCLKx = 3.072\text{ MHz}$

Figure 7-22. THD+N vs Input Frequency With a -20-dBFS Input

7.15 Typical Characteristics (continued)

at $T_A = 25^\circ\text{C}$, $AVDD = 3.3\text{ V}$, $IOVDD = 3.3\text{ V}$, $BSTVDD = 3.3\text{ V}$, $f_{IN} = 1\text{-kHz}$ sinusoidal signal, $f_S = 48\text{ kHz}$, 32-bit audio data, $BCLK = 256 \times f_S$, TDM slave mode, PLL on, channel gain = 0 dB, linear phase decimation filter, and MICBIAS programmed voltage = 8 V (unless otherwise noted); all performance measurements are done by feeding the device analog input and PDM digital input signal using audio precision with a 20-kHz, low-pass filter and an A-weighted filter (unless otherwise noted)

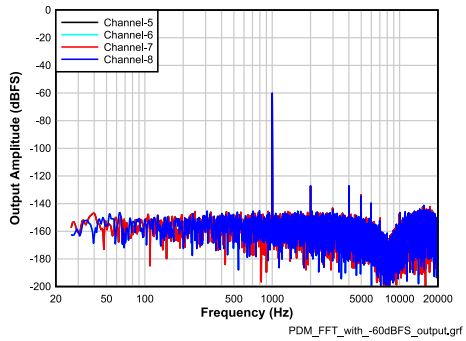

4th-order PDM modulator with PDMCLKx = 3.072 MHz

Figure 7-23. FFT With a -60-dBFS Input (non A-weighted)

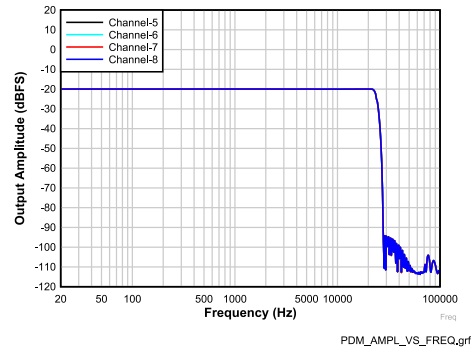

4th-order PDM modulator with PDMCLKx = 3.072 MHz

Figure 7-24. Amplitude Response With a -20-dBFS Input

8 Detailed Description

8.1 Overview

The PCM6480-Q1 is a scalable device that consists of high-performance, low-power, flexible, multichannel, audio analog-to-digital converters (ADCs) with extensive feature integration. This device is intended for automotive applications such as vehicle cabin active noise cancellation, hands-free in-vehicle communication, emergency call, and multimedia applications. The PCM6480-Q1 is a high performance audio converter that supports simultaneous sampling of up to a 4-channel analog microphone or a line input along with up to a 4-channel digital pulse density modulation (PDM) microphone input. The high dynamic range of this device enables far-field audio recording with high fidelity. This device integrates a host of features that reduce cost, board space, and power consumption in space-constrained automotive sub-system designs. Package, performance, and device-compatible configuration registers make this device well suited for scalable system designs.

The PCM6480-Q1 consists of the following blocks:

- 4-channel, multibit, high-performance delta-sigma ($\Delta\Sigma$) ADCs
- 4-channel pulse density modulation (PDM) digital microphone interface with high-performance decimation filter
- Configurable single-ended or differential audio inputs with high voltage signal swing
- High-voltage, low-noise programmable microphone bias output
- Highly flexible, comprehensive input fault diagnostic
- Automatic gain controller (AGC)
- Programmable decimation filters with linear-phase or low-latency filter
- Programmable channel gain, volume control, and biquad filters for each channel
- Programmable phase and gain calibration with fine resolution for each channel
- Programmable high-pass filter (HPF) and digital channel mixer
- Integrated low-jitter, phase-locked loop (PLL) supporting a wide range of system clocks
- Integrated digital and analog voltage regulators to support single-supply operation

Communication to the PCM6480-Q1 for configuring the control registers is supported using an I²C or SPI interface. The device supports a highly flexible audio serial interface [time-division multiplexing (TDM), I²S, or left-justified (LJ)] to transmit audio data seamlessly in the system across devices.

The device can support multiple devices by sharing the common I²C and TDM buses across devices. Moreover, the device includes a daisy-chain feature and a secondary audio serial output data pin. These features relax the shared TDM bus timing requirements and board design complexities when operating multiple devices for applications requiring high audio data bandwidth.

[Table 8-1](#) lists the reference abbreviations used throughout this document to registers that control the device.

Table 8-1. Abbreviations for Register References

| REFERENCE | ABBREVIATION | DESCRIPTION | EXAMPLE |
|------------------------------|--------------|--|---|
| Page y, register z, bit k | Py_Rz_Dk | Single data bit. The value of a single bit in a register. | Page 4, register 36, bit 0 = P4_R36_D0 |
| Page y, register z, bits k-m | Py_Rz_D[k:m] | Range of data bits. A range of data bits (inclusive). | Page 4, register 36, bits 3-0 = P4_R36_D[3:0] |
| Page y, register z | Py_Rz | One entire register. All eight bits in the register as a unit. | Page 4, register 36 = P4_R36 |
| Page y, registers z-n | Py_Rz-Rn | Range of registers. A range of registers in the same page. | Page 4, registers 36, 37, 38 = P4_R36-R38 |

8.2 Functional Block Diagram

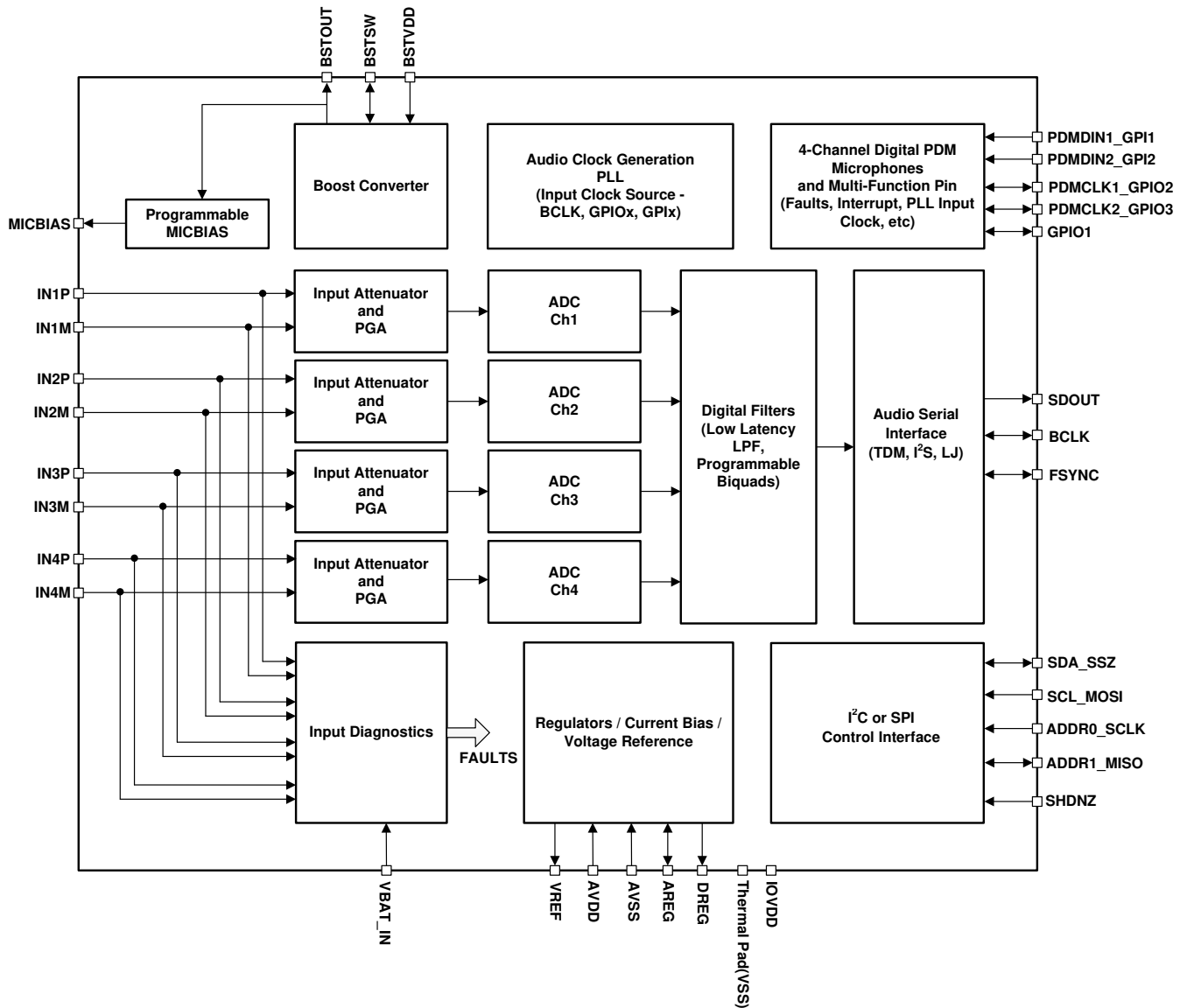

Figure 8-1. Simplified Device Functional Block Diagram

8.3 Feature Description

8.3.1 Serial Interfaces

This device has two serial interfaces: control and audio data. The control serial interface is used for device configuration. The audio data serial interface is used for transmitting audio data to the host device.

8.3.1.1 Control Serial Interfaces

The device contains configuration registers and programmable coefficients that can be set to the desired values for a specific system and application use. All registers can be accessed using either I²C or SPI communication to the device. For more information, see the [Programming](#) section.

8.3.1.2 Audio Serial Interfaces

Digital audio data flows between the host processor and the PCM6480-Q1 on the digital audio serial interface (ASI), or audio bus. This highly flexible ASI bus includes a TDM mode for multichannel operation, support for I²S or left-justified protocols format, programmable data length options, very flexible master-slave configurability for bus clock lines, and the ability to communicate with multiple devices within a system directly.

The bus protocol TDM, I²S, or left-justified (LJ) format can be selected by using the ASI_FORMAT[1:0], P0_R7_D[7:6] register bits. As shown in [Table 8-2](#) and [Table 8-3](#), these modes are all most significant byte (MSB)-first, pulse code modulation (PCM) data format, with the output channel data word-length programmable as 16, 20, 24, or 32 bits by configuring the ASI_WLEN[1:0], P0_R7_D[5:4] register bits.

Table 8-2. Audio Serial Interface Format

| P0_R7_D[7:6] : ASI_FORMAT[1:0] | AUDIO SERIAL INTERFACE FORMAT |
|--------------------------------|--|
| 00 (default) | Time division multiplexing (TDM) mode |
| 01 | Inter IC sound (I ² S) mode |
| 10 | Left-justified (LJ) mode |
| 11 | Reserved (do not use this setting) |

Table 8-3. Audio Output Channel Data Word-Length

| P0_R7_D[5:4] : ASI_WLEN[1:0] | AUDIO OUTPUT CHANNEL DATA WORD-LENGTH |
|------------------------------|--|
| 00 | Output channel data word-length set to 16 bits |
| 01 | Output channel data word-length set to 20 bits |
| 10 | Output channel data word-length set to 24 bits |
| 11 (default) | Output channel data word-length set to 32 bits |

The frame sync pin, FSYNC, is used in this audio bus protocol to define the beginning of a frame and has the same frequency as the output data sample rates. The bit clock pin, BCLK, is used to clock out the digital audio data across the serial bus. The number of bit clock cycles in a frame must accommodate multiple device active output channels with the programmed data word length.

A frame consists of multiple time-division channel slots (up to 64) to allow all output channel audio data transmissions to complete on the audio bus by a device or multiple PCM6480-Q1 devices sharing the same audio bus. The device supports up to eight output channels that can be configured to place their audio data on bus slot 0 to slot 63. [Table 8-4](#) lists the output channel slot configuration settings. In I²S and LJ mode, the slots are divided into two sets, left-channel slots and right-channel slots, as described in the [Inter IC Sound \(I²S\) Interface](#) and [Left-Justified \(LJ\) Interface](#) sections.

Table 8-4. Output Channel Slot Assignment Settings

| P0_R11_D[5:0] : CH1_SLOT[5:0] | OUTPUT CHANNEL 1 SLOT ASSIGNMENT |
|-------------------------------|--|
| 00 0000 = 0d (default) | Slot 0 for TDM or left slot 0 for I ² S, LJ. |
| 00 0001 = 1d | Slot 1 for TDM or left slot 1 for I ² S, LJ. |
| ... | ... |
| 01 1111 = 31d | Slot 31 for TDM or left slot 31 for I ² S, LJ. |
| 10 0000 = 32d | Slot 32 for TDM or right slot 0 for I ² S, LJ. |
| ... | ... |
| 11 1110 = 62d | Slot 62 for TDM or right slot 30 for I ² S, LJ. |
| 11 1111 = 63d | Slot 63 for TDM or right slot 31 for I ² S, LJ. |

Similarly, the slot assignment setting for output channel 2 to channel 6 can be done using the CH2_SLOT (P0_R12) to CH6_SLOT (P0_R16) registers, respectively.

The slot word length is the same as the output channel data word length set for the device. The output channel data word length must be set to the same value for all PCM6480-Q1 devices if all devices share the same ASI bus in a system. The maximum number of slots possible for the ASI bus in a system is limited by the available bus bandwidth, which depends upon the BCLK frequency, output data sample rate used, and the channel data word length configured.

The device also includes a feature that offsets the start of the slot data transfer with respect to the frame sync by up to 31 cycles of the bit clock. [Table 8-5](#) lists the programmable offset configuration settings.

Table 8-5. Programmable Offset Settings for the ASI Slot Start

| P0_R8_D[4:0] : TX_OFFSET[4:0] | PROGRAMMABLE OFFSET SETTING FOR SLOT DATA TRANSMISSION START |
|-------------------------------|--|
| 0 0000 = 0d (default) | The device follows the standard protocol timing without any offset. |
| 0 0001 = 1d | Slot start is offset by one BCLK cycle, as compared to standard protocol timing. For I ² S or LJ, the left and right slot start is offset by one BCLK cycle, as compared to standard protocol timing. |
| | |
| 1 1110 = 30d | Slot start is offset by 30 BCLK cycles, as compared to standard protocol timing. For I ² S or LJ, the left and right slot start is offset by 30 BCLK cycles, as compared to standard protocol timing. |
| 1 1111 = 31d | Slot start is offset by 31 BCLK cycles, as compared to standard protocol timing. For I ² S or LJ, the left and right slot start is offset by 31 BCLK cycles, as compared to standard protocol timing. |

The device also features the ability to invert the polarity of the frame sync pin, FSYNC, used to transfer the audio data as compared to the default FSYNC polarity used in standard protocol timing. This feature can be set using the FSYNC_POL, P0_R7_D3 register bit. Similarly, the device can invert the polarity of the bit clock pin, BCLK, which can be set using the BCLK_POL, P0_R7_D2 register bit.

8.3.1.2.1 Time Division Multiplexed Audio (TDM) Interface

In TDM mode, also known as DSP mode, the rising edge of FSYNC starts the data transfer with the slot 0 data first. Immediately after the slot 0 data transmission, the remaining slot data are transmitted in order. FSYNC and each data bit (except the MSB of slot 0 when TX_OFFSET equals 0) is transmitted on the rising edge of BCLK. [Figure 8-2](#) to [Figure 8-5](#) illustrate the protocol timing for TDM operation with various configurations.

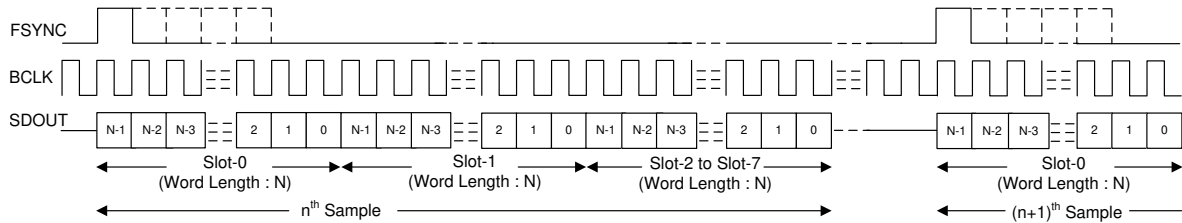

Figure 8-2. TDM Mode Standard Protocol Timing (TX_OFFSET = 0)

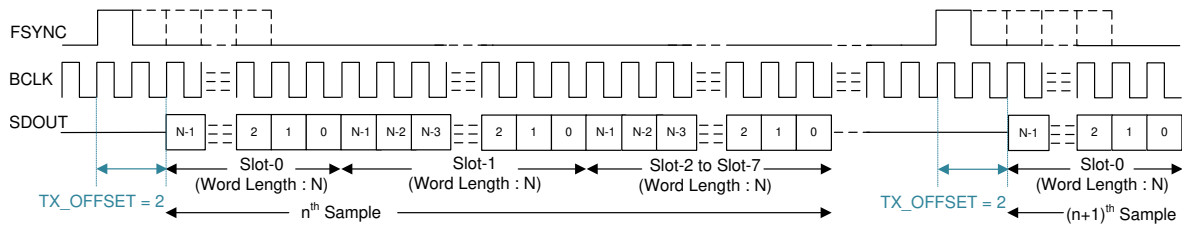

Figure 8-3. TDM Mode Protocol Timing (TX_OFFSET = 2)

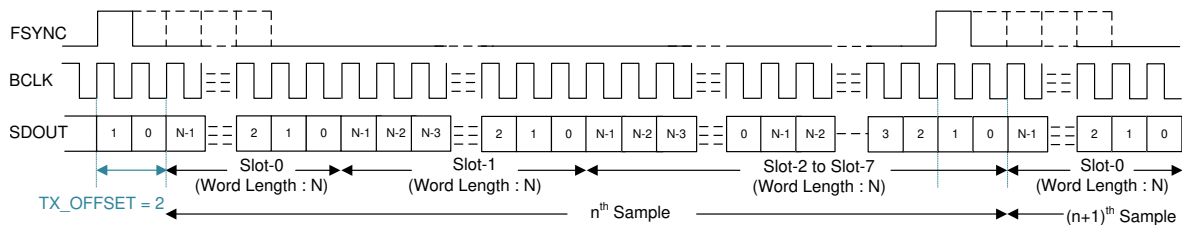

Figure 8-4. TDM Mode Protocol Timing (No Idle BCLK Cycles, TX_OFFSET = 2)

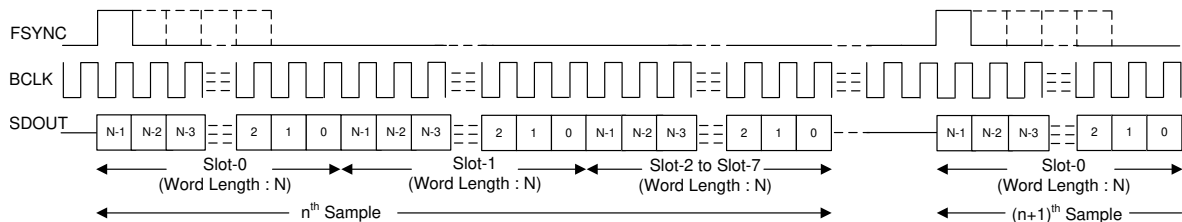

Figure 8-5. TDM Mode Protocol Timing (TX_OFFSET = 0 and BCLK_POL = 1)

For proper operation of the audio bus in TDM mode, the number of bit clocks per frame must be greater than or equal to the number of active output channels times the programmed word length of the output channel data. The device supports FSYNC as a pulse with a 1-cycle-wide bit clock, but also supports multiples as well. For a higher BCLK frequency operation, using TDM mode with a TX_OFFSET value higher than 0 is recommended.

8.3.1.2.2 Inter IC Sound (I²S) Interface

The standard I²S protocol is defined for only two channels: left and right. The device extends the same protocol timing for multichannel operation. In I²S mode, the MSB of the left slot 0 is transmitted on the falling edge of BCLK in the second cycle after the *falling* edge of FSYNC. Immediately after the left slot 0 data transmission, the remaining left slot data are transmitted in order. The MSB of the right slot 0 is transmitted on the falling edge of BCLK in the second cycle after the *rising* edge of FSYNC. Immediately after the right slot 0 data transmission, the remaining right slot data are transmitted in order. FSYNC and each data bit is transmitted on the falling edge of BCLK. Figure 8-6 to Figure 8-9 illustrate the protocol timing for I²S operation with various configurations.

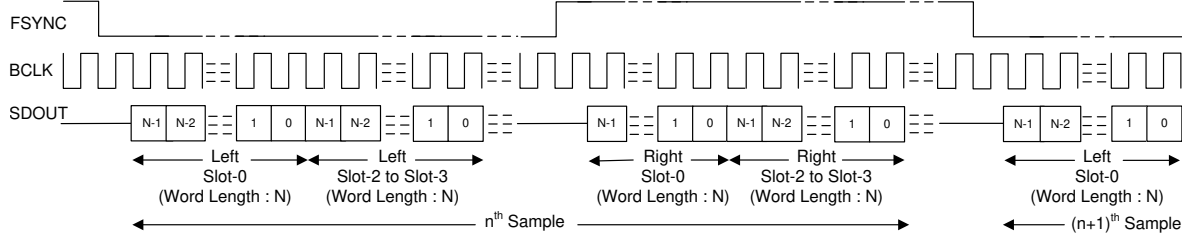

Figure 8-6. I²S Mode Standard Protocol Timing (TX_OFFSET = 0)

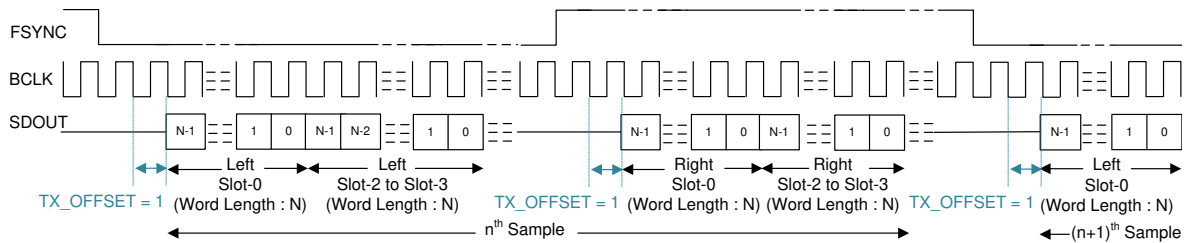

Figure 8-7. I²S Protocol Timing (TX_OFFSET = 1)

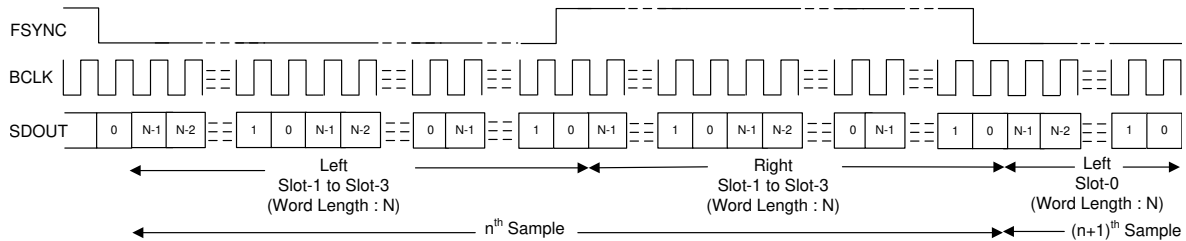

Figure 8-8. I²S Protocol Timing (No Idle BCLK Cycles, TX_OFFSET = 0)

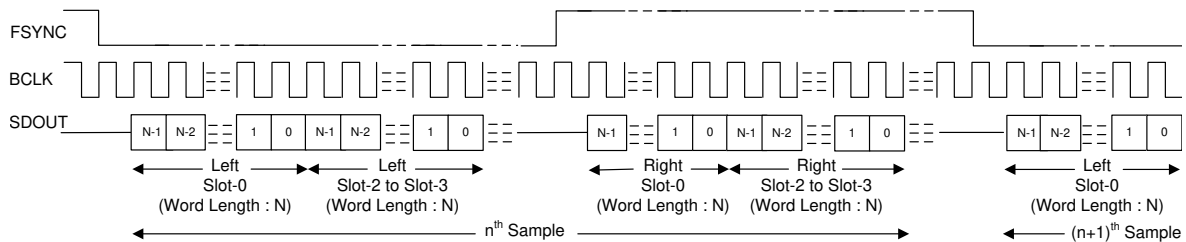

Figure 8-9. I²S Protocol Timing (TX_OFFSET = 0 and BCLK_POL = 1)

For proper operation of the audio bus in I²S mode, the number of bit clocks per frame must be greater than or equal to the number of active output channels (including left and right slots) times the programmed word length of the output channel data. The device FSYNC low pulse must be a number of BCLK cycles wide that is greater than or equal to the number of active left slots times the data word length configured. Similarly, the FSYNC high pulse must be a number of BCLK cycles wide that is greater than or equal to the number of active right slots times the data word length configured.

8.3.1.2.3 Left-Justified (LJ) Interface

The standard LJ protocol is defined for only two channels: left and right. The device extends the same protocol timing for multichannel operation. In LJ mode, the MSB of the left slot 0 is transmitted in the same BCLK cycle after the *rising* edge of FSYNC. Each subsequent data bit is transmitted on the falling edge of BCLK. Immediately after the left slot 0 data transmission, the remaining left slot data are transmitted in order. The MSB of the right slot 0 is transmitted in the same BCLK cycle after the *falling* edge of FSYNC. Each subsequent data bit is transmitted on the falling edge of BCLK. Immediately after the right slot 0 data transmission, the remaining right slot data are transmitted in order. FSYNC is transmitted on the falling edge of BCLK. [Figure 8-10](#) to [Figure 8-13](#) illustrate the protocol timing for LJ operation with various configurations.

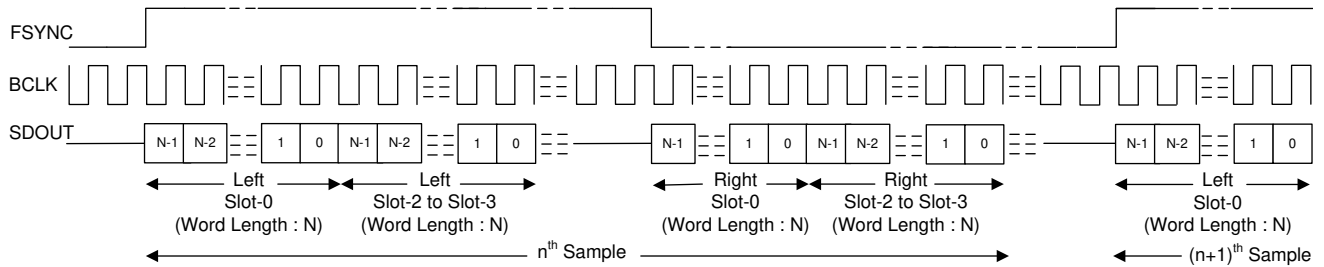

Figure 8-10. LJ Mode Standard Protocol Timing (TX_OFFSET = 0)

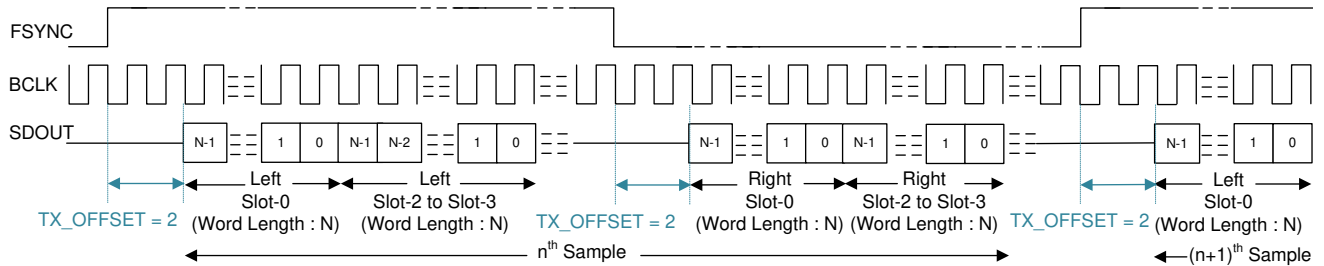

Figure 8-11. LJ Protocol Timing (TX_OFFSET = 2)

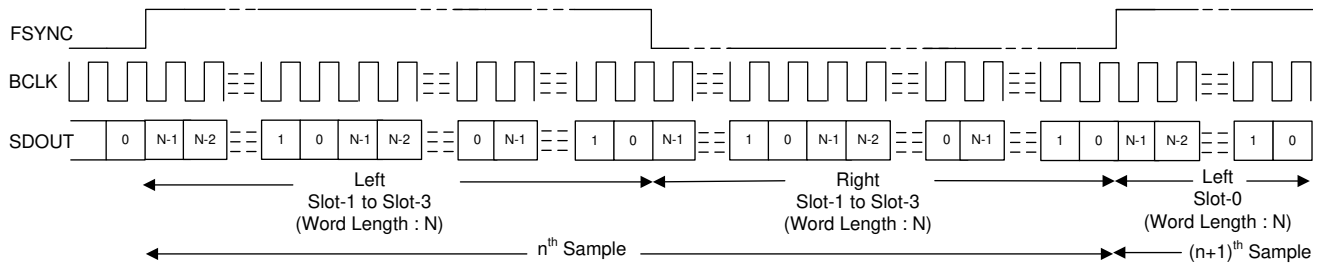

Figure 8-12. LJ Protocol Timing (No Idle BCLK Cycles, TX_OFFSET = 0)

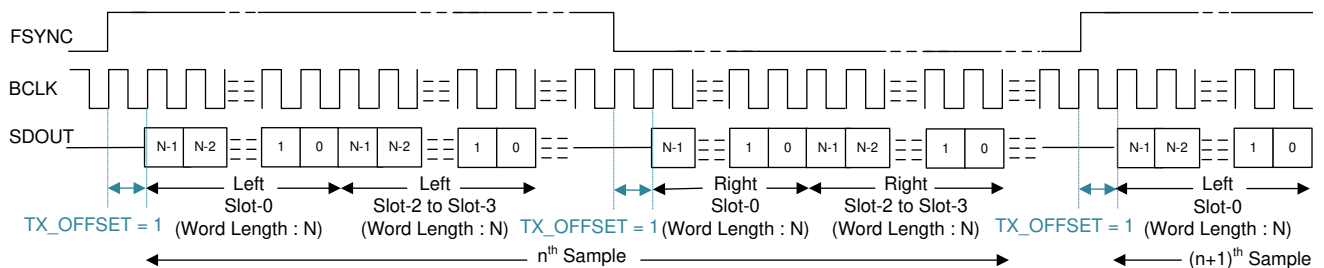

Figure 8-13. LJ Protocol Timing (TX_OFFSET = 1 and BCLK_POL = 1)

For proper operation of the audio bus in LJ mode, the number of bit clocks per frame must be greater than or equal to the number of active output channels (including left and right slots) times the programmed word length of the output channel data. The device FSYNC high pulse must be a number of BCLK cycles wide that is greater than or equal to the number of active left slots times the data word length configured. Similarly, the FSYNC low pulse must be number of BCLK cycles wide that is greater than or equal to the number of active right slots times the data word length configured. For a higher BCLK frequency operation, using LJ mode with a TX_OFFSET value higher than 0 is recommended.

8.3.1.3 Using Multiple Devices With Shared Buses

The device has many supported features and flexible options that can be used in the system to seamlessly connect multiple PCM6480-Q1 devices by sharing a single common I²C control bus and an audio serial interface bus. This architecture enables multiple applications to be applied to a system that require a microphone array for beam-forming operation, hands-free in-vehicle communication, car cabin active noise cancellation, and so forth.

Figure 8-14 shows a diagram of multiple PCM6480-Q1 devices in a configuration where the control and audio data buses are shared.

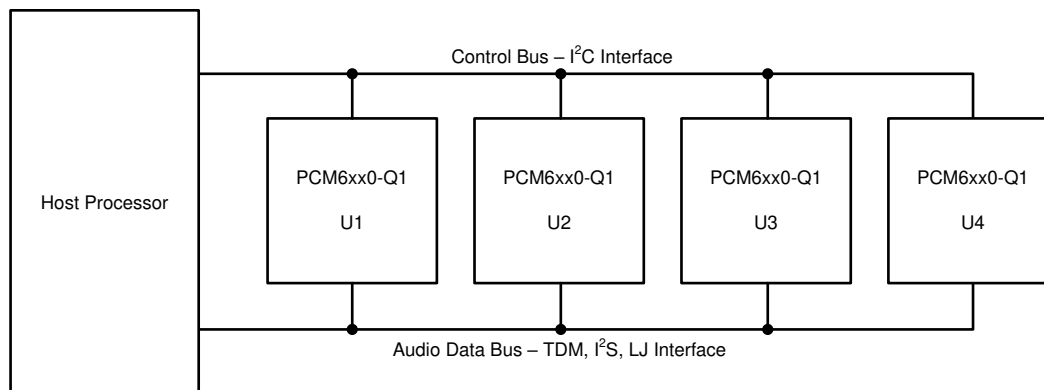

Figure 8-14. Multiple PCM6480-Q1 Devices With Shared Control and Audio Data Buses

The PCM6480-Q1 consist of the following features to enable seamless connection and interaction of multiple devices using a shared bus:

- Supports up to four pin-programmable I²C slave addresses
- I²C broadcast simultaneously writes to (or triggers) all PCM6480-Q1 devices
- Supports up to 64 configuration output channel slots for the audio serial interface
- Tri-state feature (with enable and disable) for the unused audio data slots of the device
- Supports a bus-holder feature (with enable and disable) to keep the last driven value on the audio bus
- The GPIOx pin can be configured as a secondary output data lane for the audio serial interface
- The GPIOx or GPIx pin can be used in a daisy-chain configuration of multiple PCM6480-Q1 devices
- Supports one BCLK cycle data latching timing to relax the timing requirement for the high-speed interface
- Programmable master and slave options for the audio serial interface
- Ability to synchronize the multiple devices for the simultaneous sampling requirement across devices

See the [Multiple PCM6xx0-Q1 Devices With Shared TDM and I²C Bus application report](#) for further details.

8.3.2 Phase-Locked Loop (PLL) and Clock Generation

The device has a smart auto-configuration block to generate all necessary internal clocks required for the ADC modulator and the digital filter engine used for signal processing. This configuration is done by monitoring the frequency of the FSYNC and BCLK signal on the audio bus.

The device supports the various output data sample rates (of the FSYNC signal frequency) and the BCLK to FSYNC ratio to configure all clock dividers, including the PLL configuration, internally without host programming. [Table 8-6](#) and [Table 8-7](#) list the supported FSYNC and BCLK frequencies.

Table 8-6. Supported FSYNC (Multiples or Submultiples of 48 kHz) and BCLK Frequencies

| BCLK TO FSYNC RATIO | BCLK (MHz) | | | | | | | | |
|---------------------|---------------|----------------|----------------|----------------|----------------|----------------|-----------------|-----------------|-----------------|
| | FSYNC (8 kHz) | FSYNC (16 kHz) | FSYNC (24 kHz) | FSYNC (32 kHz) | FSYNC (48 kHz) | FSYNC (96 kHz) | FSYNC (192 kHz) | FSYNC (384 kHz) | FSYNC (768 kHz) |
| 16 | Reserved | 0.256 | 0.384 | 0.512 | 0.768 | 1.536 | 3.072 | 6.144 | 12.288 |
| 24 | Reserved | 0.384 | 0.576 | 0.768 | 1.152 | 2.304 | 4.608 | 9.216 | 18.432 |
| 32 | 0.256 | 0.512 | 0.768 | 1.024 | 1.536 | 3.072 | 6.144 | 12.288 | 24.576 |
| 48 | 0.384 | 0.768 | 1.152 | 1.536 | 2.304 | 4.608 | 9.216 | 18.432 | Reserved |
| 64 | 0.512 | 1.024 | 1.536 | 2.048 | 3.072 | 6.144 | 12.288 | 24.576 | Reserved |
| 96 | 0.768 | 1.536 | 2.304 | 3.072 | 4.608 | 9.216 | 18.432 | Reserved | Reserved |
| 128 | 1.024 | 2.048 | 3.072 | 4.096 | 6.144 | 12.288 | 24.576 | Reserved | Reserved |
| 192 | 1.536 | 3.072 | 4.608 | 6.144 | 9.216 | 18.432 | Reserved | Reserved | Reserved |
| 256 | 2.048 | 4.096 | 6.144 | 8.192 | 12.288 | 24.576 | Reserved | Reserved | Reserved |
| 384 | 3.072 | 6.144 | 9.216 | 12.288 | 18.432 | Reserved | Reserved | Reserved | Reserved |
| 512 | 4.096 | 8.192 | 12.288 | 16.384 | 24.576 | Reserved | Reserved | Reserved | Reserved |
| 1024 | 8.192 | 16.384 | 24.576 | Reserved | Reserved | Reserved | Reserved | Reserved | Reserved |
| 2048 | 16.384 | Reserved | Reserved | Reserved | Reserved | Reserved | Reserved | Reserved | Reserved |

Table 8-7. Supported FSYNC (Multiples or Submultiples of 44.1 kHz) and BCLK Frequencies

| BCLK TO FSYNC RATIO | BCLK (MHz) | | | | | | | | |
|---------------------|------------------|------------------|-------------------|------------------|------------------|------------------|-------------------|-------------------|-------------------|
| | FSYNC (7.35 kHz) | FSYNC (14.7 kHz) | FSYNC (22.05 kHz) | FSYNC (29.4 kHz) | FSYNC (44.1 kHz) | FSYNC (88.2 kHz) | FSYNC (176.4 kHz) | FSYNC (352.8 kHz) | FSYNC (705.6 kHz) |
| 16 | Reserved | Reserved | 0.3528 | 0.4704 | 0.7056 | 1.4112 | 2.8224 | 5.6448 | 11.2896 |
| 24 | Reserved | 0.3528 | 0.5292 | 0.7056 | 1.0584 | 2.1168 | 4.2336 | 8.4672 | 16.9344 |
| 32 | Reserved | 0.4704 | 0.7056 | 0.9408 | 1.4112 | 2.8224 | 5.6448 | 11.2896 | 22.5792 |
| 48 | 0.3528 | 0.7056 | 1.0584 | 1.4112 | 2.1168 | 4.2336 | 8.4672 | 16.9344 | Reserved |
| 64 | 0.4704 | 0.9408 | 1.4112 | 1.8816 | 2.8224 | 5.6448 | 11.2896 | 22.5792 | Reserved |
| 96 | 0.7056 | 1.4112 | 2.1168 | 2.8224 | 4.2336 | 8.4672 | 16.9344 | Reserved | Reserved |
| 128 | 0.9408 | 1.8816 | 2.8224 | 3.7632 | 5.6448 | 11.2896 | 22.5792 | Reserved | Reserved |
| 192 | 1.4112 | 2.8224 | 4.2336 | 5.6448 | 8.4672 | 16.9344 | Reserved | Reserved | Reserved |
| 256 | 1.8816 | 3.7632 | 5.6448 | 7.5264 | 11.2896 | 22.5792 | Reserved | Reserved | Reserved |
| 384 | 2.8224 | 5.6448 | 8.4672 | 11.2896 | 16.9344 | Reserved | Reserved | Reserved | Reserved |
| 512 | 3.7632 | 7.5264 | 11.2896 | 15.0528 | 22.5792 | Reserved | Reserved | Reserved | Reserved |
| 1024 | 7.5264 | 15.0528 | 22.5792 | Reserved | Reserved | Reserved | Reserved | Reserved | Reserved |
| 2048 | 15.0528 | Reserved | Reserved | Reserved | Reserved | Reserved | Reserved | Reserved | Reserved |

The status register ASI_STS, P0_R21, captures the device auto detect result for the FSYNC frequency and the BCLK to FSYNC ratio. If the device finds any unsupported combinations of FSYNC frequency and BCLK to FSYNC ratios, the device generates an ASI clock-error interrupt and mutes the record channels accordingly.

The device uses an integrated, low-jitter, phase-locked loop (PLL) to generate internal clocks required for the ADC modulator and digital filter engine, as well as other control blocks. The device also supports an option to

use the BCLK, GPIOx, or the GPIO pin (as MCLK) as the audio clock source without using the PLL to reduce power consumption. However, the ADC performance may degrade based on jitter from the external clock source, and some processing features may not be supported if the external audio clock source frequency is not high enough. Therefore, TI recommends using the PLL for high-performance applications.

The device also supports an audio bus master mode operation using the GPIOx or GPIO pin (as MCLK) as the reference input clock source and supports various flexible options and a wide variety of system clocks. More details and information on master mode configuration and operation are discussed in the [Configuring and Operating TLV320ADCx140 as Audio Bus Master application report](#).

The audio bus clock error detection and auto-detect feature automatically generates all internal clocks, but can be disabled using the ASI_ERR, P0_R9_D5 and AUTO_CLK_CFG, P0_R19_D6, register bits, respectively. In the system, this disable feature can be used to support custom clock frequencies that are not covered by the auto detect scheme. For such application use cases, care must be taken to ensure that the multiple clock dividers are all configured appropriately. Therefore, TI recommends using the PPC3 GUI for device configuration settings; for more details see the [PCM6xx0Q1EVM-PDK Evaluation Module user's guide](#) and the [PurePath™ Console Graphical Development Suite for Audio System Design and Development development suite](#).

8.3.3 Analog Input Channel Configuration

The PCM6480-Q1 consists of four pairs of analog input pins (INxP and INxM) that can be configured as either differential or single-ended inputs for the recording channel. The device supports simultaneous recording of up to four channels using the multichannel ADC. The input source for the analog pins can be either analog microphones or line, aux inputs from the system board. [Table 8-8](#) describes how to set the input configuration for the record channel.

Table 8-8. Input Source Selection for the Record Channel

| P0_R60_D[6:5] : CH1_INSRC[1:0] | INPUT CHANNEL 1 RECORD SOURCE SELECTION |
|-----------------------------------|---|
| 00 (default) | Analog differential input for channel 1 |
| 01 | Analog single-ended input for channel 1 |
| 10 or 11 | Reserved (do not use this setting) |

Similarly, the input source selection setting for input channel 2 to channel 6 can be configured using the CH2_INSRC[1:0] (P0_R65_D[6:5]) to CH6_INSRC[1:0] (P0_R85_D[6:5]) registers bits, respectively.

The device supports the input DC fault diagnostic feature for microphone recording with the DC-coupled inputs configuration; however, the device also supports an option for AC-coupled inputs if the DC diagnostic is not required for the specific input pins. This configuration can be done independently for each channel by setting the CH1_DC (P0_R60_D4) to CH6_DC (P0_R85_D4) register bits.

For the DC-coupled line input configuration, the DC common-mode difference (INxP – INxM) for the analog input pins must be 0 V to support the $10\text{-}V_{\text{RMS}}$ full-scale differential input. For the DC-coupled microphone input configuration, the DC common-mode difference (INxP – INxM) for the analog input pins must be within 3.4 V to 5.0 V to support the $2\text{-}V_{\text{RMS}}$ full-scale differential input in the default mode of operation. Alternatively, the device has a mode to support more than a $2\text{-}V_{\text{RMS}}$ differential DC-coupled microphone signal by setting the CH1_MIC_IN_RANGE, P0_R60_D3, register bit for channel 1 and, similarly, the CH2_MIC_IN_RANGE, P0_R65_D3 to CH6_MIC_IN_RANGE, P0_R85_D3 registers bit (respectively) for channels 2 to 6. If the CH1_MIC_IN_RANGE bit is set high (the recommended setting to support a higher DC common-mode difference and a higher AC signal swing), then the device supports the maximum differential input voltage IN1P–IN1M as high as 8.4 V (for the MICBIAS 9-V setting), including the AC signal and DC differential common-mode voltage. The DC differential common-mode voltage is later filtered out by the digital high-pass filter and the digital output full-scale corresponds to the $10\text{-}V_{\text{RMS}}$ AC signal in this case.

Figure 8-15 and Figure 8-16 show how to connect a DC-coupled microphone for a differential and single-ended input, respectively. The value of the external bias resistor, R1, must be appropriately chosen based upon the microphone impedance. For a differential input, the value of the external bias resistor is recommended to be used for half of the microphone impedance, whereas for a single-ended input, the external bias resistor is recommended to be the same as the microphone impedance.

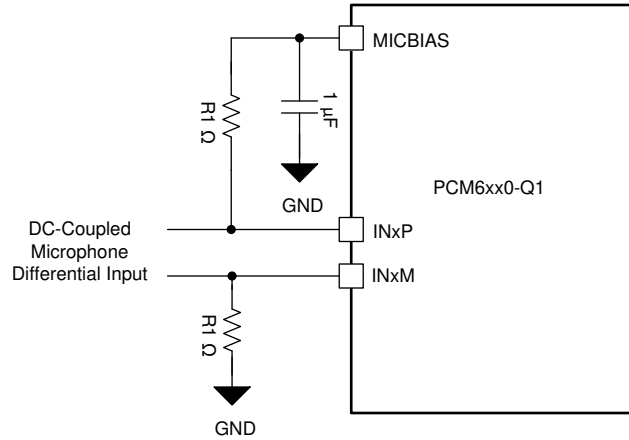

Figure 8-15. DC-Coupled Microphone Differential Input Connection

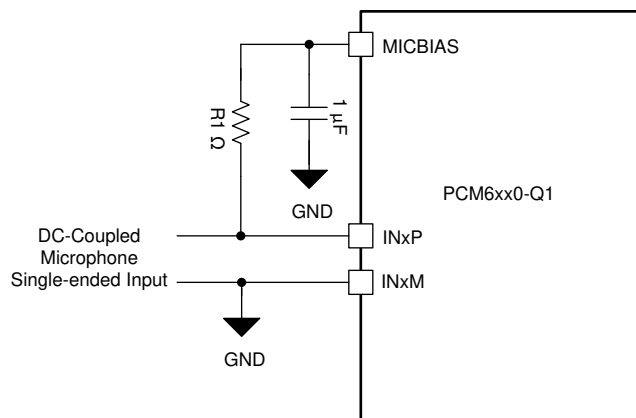

Figure 8-16. DC-Coupled Microphone Single-Ended Input Connection

In AC-coupled mode, the value of the coupling capacitor must be so chosen that the high-pass filter formed by the coupling capacitor and the input impedance do not affect the signal content. At power-up, before proper recording can begin, this coupling capacitor must be charged up to the common-mode voltage. For single-ended input configuration, the INxM pin must be grounded after the AC coupling capacitor in AC-coupled mode.

Figure 8-17 and Figure 8-18 show how to connect an AC-coupled microphone or line source for a differential and single-ended input, respectively. In AC-coupled mode, the device input pins INxP and INxM, must be biased appropriately for the DC common-mode value either using the on-chip MICBIAS output voltage along with external bias resistor, R0, or using an external bias generator circuit. The maximum value for resistor R0 depends upon the signal swing and the MICBIAS value programmed. See the [PCM6xx0-Q1 AC Coupled External Resistor Calculator](#) to calculate the R0 value for the desired system configuration.

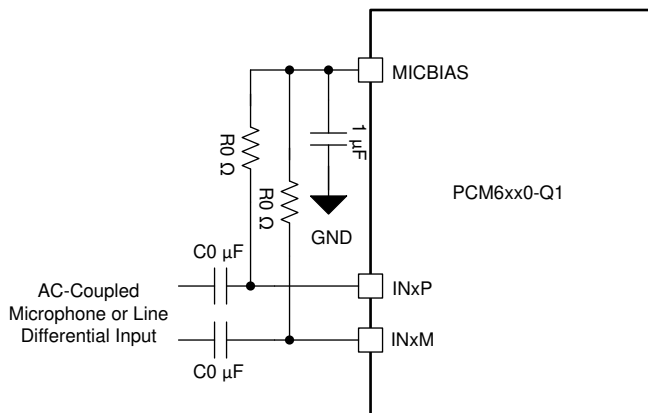

Figure 8-17. AC-Coupled Microphone or Line Differential Input Connection

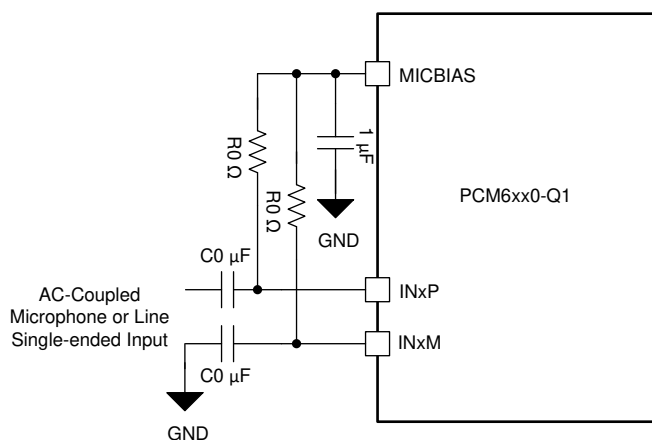

Figure 8-18. AC-Coupled Microphone or Line Single-Ended Input Connection

8.3.4 Reference Voltage

All audio data converters require a DC reference voltage. The PCM6480-Q1 achieves its low-noise performance by internally generating a low-noise reference voltage. This reference voltage is generated using a band-gap circuit with good PSRR performance. This audio converter reference voltage must be filtered externally using a minimum 1-µF capacitor connected from the VREF pin to the analog ground (AVSS).

To achieve low power consumption, this audio reference block is powered down in sleep mode or software shutdown; see the [Sleep Mode or Software Shutdown](#) section for more details. When exiting sleep mode, the audio reference block is powered up using internal fast-charge scheme and the VREF pin settles to its steady-state voltage after the settling time (a function of the decoupling capacitor on the VREF pin). This time is approximately equal to 3.5 ms when using a 1-µF decoupling capacitor. If a higher value of the decoupling capacitor is used on the VREF pin, the fast-charge setting must be reconfigured using the VREF_QCHG, PO_R2_D[4:3] register bits, which support options of 3.5 ms (default), 10 ms, 50 ms, or 100 ms.

8.3.5 Microphone Bias

The device integrates a built-in, low-noise, programmable, high-voltage, microphone bias pin (MICBIAS) that can be used in the system for biasing the analog microphone. The integrated bias amplifier supports up to 80 mA of

load current, which can be used for multiple microphones and is designed to provide a combination of high PSRR, low noise, and programmable bias voltages to allow the biasing to be fine tuned for specific microphone combinations. The PCM6480-Q1 has an integrated efficient boost converter to generate the high voltage supply for the programmable microphone bias using an external, low-voltage, 3.3-V BSTVDD supply.

When using the MICBIAS pin for biasing multiple microphones, TI recommends avoiding common impedance on the board layout for the MICBIAS connection to minimize coupling across microphones. [Table 8-9](#) shows the available microphone bias programmable options.

Table 8-9. MICBIAS Programmable Settings

| P0_R59_D[7:4] : MBIAS_VAL[3:0] | MICBIAS OUTPUT VOLTAGE |
|---------------------------------------|--------------------------------------|
| 0000 to 0110 | Reserved (do not use these settings) |
| 0111 | Set to 5.0 V |
| 1000 | Set to 5.5 V |
| 1001 | Set to 6.0 V |
| 1010 | Set to 6.5 V |
| 1011 | Set to 7.0 V |
| 1100 | Set to 7.5 V |
| 1101 | Set to 8.0 V |
| 1110 | Set to 8.5 V |
| 1111 | Set to 9.0 V |

The microphone bias output can be powered on or powered off (default) by configuring the MICBIAS_PDZ, P0_R117_D7 register bit. Additionally, the device provides an option to configure the GPIOx pins to directly control the microphone bias output power on or power off. This feature is useful in some systems to control the microphone directly without engaging the host for I²C or SPI communication. The MICBIAS_PDZ, P0_R117_D7 register bit value is ignored if the GPIOx pins are configured to control the microphone bias power on or power off.

8.3.6 Input DC Fault Diagnostics

Each input of the PCM6480-Q1 features highly comprehensive DC fault diagnostics that can be configured to detect fault conditions in the DC-coupled input configuration and trigger an interrupt request to a host processor. Diagnostics are enabled for each channel by configuring DIAG_CFG0, P0_R100. For channels with diagnostics enabled, the input pins are scanned automatically by an integrated SAR ADC with a programmable repetition rate. The repetition rate can be configured using the REP_RATE, P0_R103_D7-6 register bits. For fastest fault response time and also to get better signal integrity and signal chain performance for the record channel, REP_RATE must be configured to 0 (non-default setting) . The diagnostic processor averages eight consecutive samples per test to improve noise performance. The DC fault diagnostics is not supported in the AC-coupled input configuration.

The device features various programmable threshold registers, P0_R101 to P0_R102, which can be configured by the host processor to define the fault region for a different category of fault condition detection. Additionally, there is also a debounce feature, configured with FAULT_DBNCE_SEL, P0_R103_D3-2. This feature sets the number of consecutive scan counts where the fault condition occurs before the latched status register is tripped, thus reducing false triggers by transient events. The device also has a moving average feature, P0_R104, which continuously averages out the newly measured data with old measured data and thus reduces the false triggers by any short-duration transient events.

8.3.6.1 Fault Conditions

8.3.6.1.1 Input Pin Short to Ground

A short to ground fault occurs when the voltage of the input pin is measured below the threshold voltage with respect to ground (AVSS). The threshold can be set by configuring DIAG_SHT_GND, P0_R102_D7-4.

8.3.6.1.2 Input Pin Short to MICBIAS

A short to MICBIAS fault occurs when the difference between the voltage measured for the MICBIAS pin and the input pin (MICBIAS – INxx) is less than the threshold. The threshold can be set by configuring DIAG_SHT_MICBIAS, P0_R102_D3-0.

8.3.6.1.3 Open Inputs

In the event that a microphone becomes disconnected from the inputs, the microphone bias resistors pull INxP to MICBIAS and INxM to ground. The combination of INxP shorted to MICBIAS and INxM shorted to ground for the same channel in a diagnostic sweep results in an open input fault condition.

8.3.6.1.4 Short Between INxP and INxM

An input terminal shorted fault occurs when the difference between the voltage measured for the input pin INxP and the input pin INxM of the same channel is less than the threshold. The threshold can be set by configuring DIAG_SHT_TERM, P0_R101_D7-4.

8.3.6.1.5 Input Pin Overvoltage

An input terminal overvoltage fault occurs when the voltage measured for the input pin is above the voltage measured for the MICBIAS pin.

8.3.6.1.6 Input Pin Short to VBAT_IN

A short to VBAT_IN fault occurs when the difference between the voltage measured for the VBAT_IN pin and the input pin, ABS(VBAT_IN – INxx), is less than the threshold or both the VBAT_IN and INxx pin measured voltages are above 11.7 V. The threshold can be set by configuring DIAG_SHT_VBAT_IN, P0_R101_D3-0.

When VBAT_IN is less than MICBIAS, false fault detections can exist based on the signal level of the INxx pin. To minimize false detections there is also a separate debounce count for this condition set by configuring VSHORT_DBNCE, P0_R106_D1.

8.3.6.2 Fault Reporting

Faults are reported in live and latched status registers. The live registers, P1_R45 to P1_R55, are updated continuously with each new scan and report the most recent measurements reported by the diagnostics processor. The latched status of each diagnostic fault is reported by the channel in P0_R46 to P0_R55, and a latched summary by the channel is reported in CHx_LTCH, P0_R45. If LTCH_CLR_ON_READ, P0_R40_D0, is set to '0', then the latched registers clear upon reading and are latched if the associated bit in the live fault registers transitions from a '0' to a '1'. A transition of any bit in the latched register from a '0' to '1' triggers an interrupt request.

For detecting a persistent fault, an additional mode is available for the latched registers. In this mode, the latched registers are only cleared upon reading if the status bit in the associated live status register is '0' at the time of reading. This mode is enabled (default setting) by configuring LTCH_CLR_ON_READ, P0_R40_D0 to a '1'.

8.3.6.2.1 Overcurrent and Overtemperature Protection

The device has an overcurrent protection circuit that limits the current drawn out of the MICBIAS output to the maximum supported level when an external undesired short event occurs on the MICBIAS pin. The device sets the status flag, P0_R44_D4 bit, on an overcurrent detection. Additionally, the device has an overtemperature detection circuit that is enabled by default and sets the status flag, P0_R44_D5 bit, whenever the die junction temperature goes higher than the supported level.

Additionally, the P0_R58 and P0_R40_D4:3 register can be configured to shutdown MICBIAS along with the on-chip boost on an overtemperature detection. TI recommends configuring PD_ON_FLT_CFG, P0_R40_D4-3 to "10" so that on an overtemperature detection, the device powers-down MICBIAS, the on-chip boost, and all ADC channels.

More details and information on fault diagnostics are discussed in the [PCM6xx0-Q1 Fault Diagnostics Features application report](#).

8.3.7 Digital PDM Microphone Record Channel

In addition to supporting analog microphones, the device also interfaces to digital PDM microphones and uses high order and high performance decimation filters to generate PCM output data which can be transmitted on audio serial interface to host. The PDMINx_GPIOx and PDMCLKx_GPIOx pins respectively and can be configured for PDMIN and PDMCLK for digital PDM microphone recording. The device support up to four digital microphone recording channel.

The device internally generates PCMCLK with a programmable frequency either 6.144 MHz, 3.072 MHz, 1.536 MHz, or 768 kHz (for output data sample rates that are multiples or sub-multiples of 48 kHz) or 5.6448 MHz, 2.8224 MHz, 1.4112 MHz, or 705.6 kHz (for output data sample rates that are multiples or sub-multiples of 44.1 kHz) using PDMCLK_DIV[1:0], P0_R31_D[1:0] register bits. This PDMCLK can be routed on the PDMCLKx_GPIOx pin. As shown in [Figure 8-19](#), this clock can be connected to the external digital microphone device.

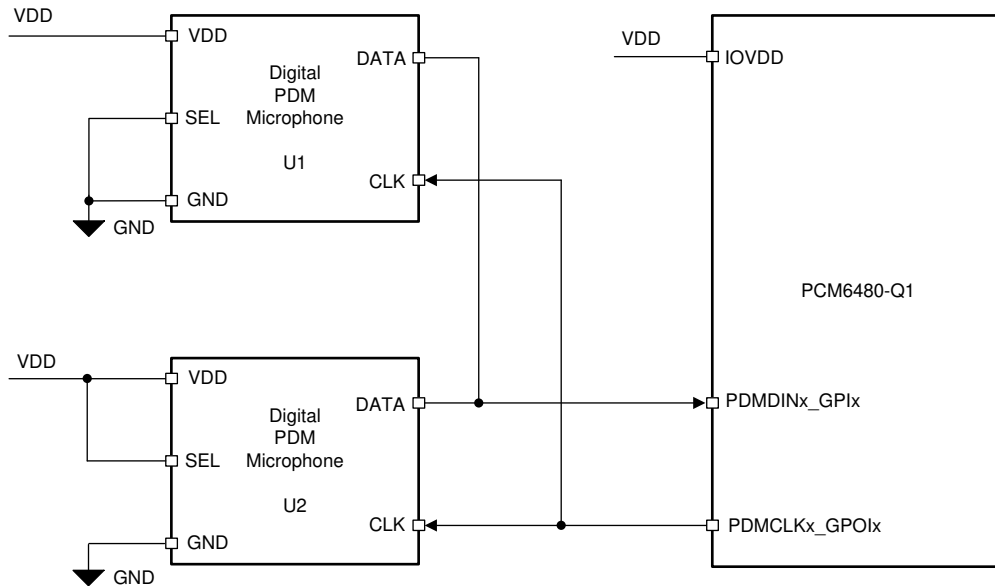

Figure 8-19. Digital PDM Microphones Connection Diagram to the PCM6480-Q1

The single-bit output of the external digital microphone device can be connected to the PDMCLKx_GPIx pins. The single data line can be shared by two digital microphones to place their data on the opposite edge of PDMCLK. Internally, the device latches the steady value of data on the rising edge of PDMCLK or the falling edge of PDMCLK based on the configuration register bits set in P0_R32_D[7:4]. [Figure 8-20](#) shows the digital PDM microphone interface timing diagram.

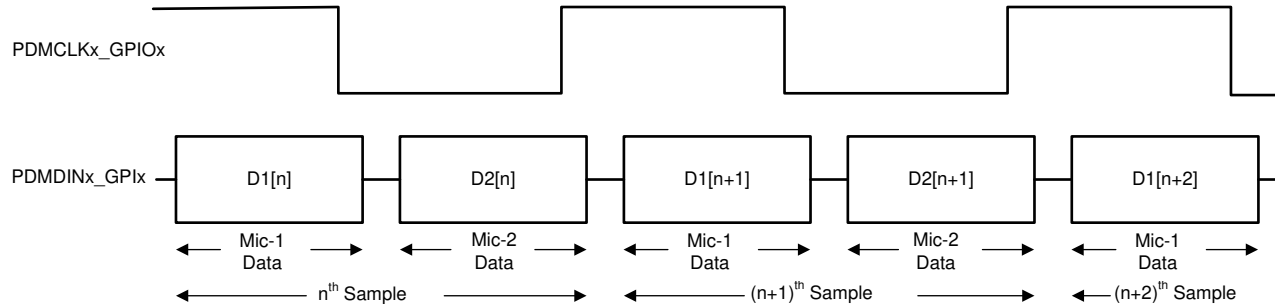

Figure 8-20. Digital PDM Microphone Protocol Timing Diagram

When the digital microphone is used for recording, the analog section of the respective ADC channel is powered down and bypassed for power efficiency. Selecting the analog microphone or digital microphone for channel 1 to channel 4 is done by using the CH5_INSRC[1:0] (P0_R80_D[6:5]), CH6_INSRC[1:0] (P0_R85_D[6:5]), CH7_INSRC[1:0] (P0_R90_D[6:5]), and CH8_INSRC[1:0] (P0_R95_D[6:5]) register bits.

8.3.8 Signal-Chain Processing

The PCM6480-Q1 signal chain is comprised of very-low-noise, high-performance, and low-power analog blocks and highly flexible and programmable digital processing blocks. The high performance and flexibility combined with a compact package makes the PCM6480-Q1 optimized for a variety of end-equipment and applications that require multichannel audio capture. Figure 8-21 shows a conceptual block diagram that highlights the various building blocks used in the signal chain, and how the blocks interact in the signal chain.

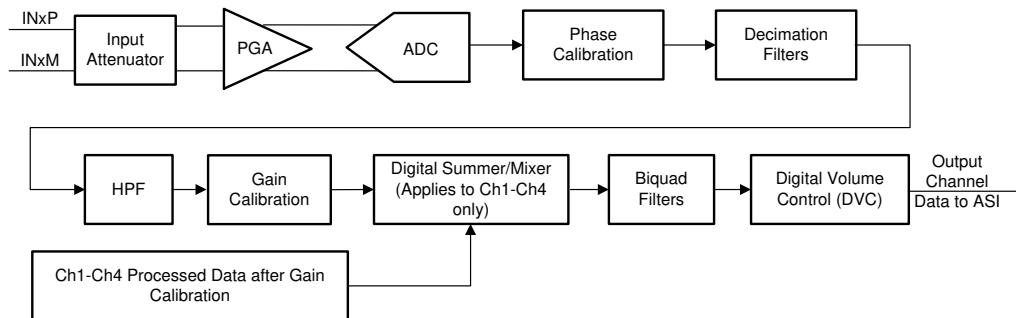

Figure 8-21. Analog Input Signal-Chain Processing Flowchart

The front-end input attenuator allows the device to accept the high-voltage input signal that is attenuated by the input attenuator circuit before being routed to a low-noise programmable gain amplifier (PGA). Along with a low-noise and low-distortion, multibit, delta-sigma ADC, the front-end PGA enables the PCM6480-Q1 to record a far-field audio signal with very high fidelity, both in quiet and loud environments. Moreover, the ADC architecture has inherent antialias filtering with a high rejection of out-of-band frequency noise around multiple modulator frequency components. Therefore, the device prevents noise from aliasing into the audio band during ADC sampling. Further on in the signal chain, an integrated, high-performance multistage digital decimation filter sharply cuts off any out-of-band frequency noise with high stop-band attenuation.

The device also has an integrated programmable biquad filter that allows for custom low-pass, high-pass, or any other desired frequency shaping. Thus, the overall signal chain architecture removes the requirement to add external components for antialiasing low-pass filtering, and thus saves drastically on the external system component cost and board space. See the [PCM6xx0-Q1 Integrated Analog Antialiasing Filter and Flexible Digital Filter application report](#) for further details.

The device also supports up to a 4-channel digital PDM microphone recording for channels using the PDMINx_GPIOx and PDMCLKx_GPIOx pins. The channel 1 to channel 4 signal chain block diagram is same as shown in Figure 8-21; however, channel 5 to channel 8 only support a digital microphone recording option, as shown in Figure 8-22, and do not support the digital summer or mixer option.

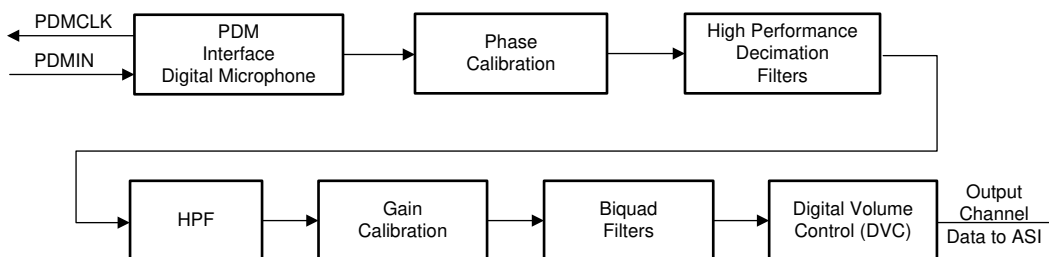

Figure 8-22. Digital PDM Input Signal-Chain Processing Flowchart

The signal chain also consists of various highly programmable digital processing blocks, such as phase calibration, gain calibration, high-pass filter, digital summer or mixer, biquad filters, and volume control. The details on these processing blocks are discussed further in this section.

The desired input channels for recording can be enabled or disabled by using the IN_CH_EN (P0_R115) register, and the output channels for the audio serial interface can be enabled or disabled by using the ASI_OUT_EN (P0_R116) register. In general, the device supports simultaneous power-up and power-down of all

active channels for simultaneous recording. However, based on the application needs, if some channels must be powered-up or powered-down dynamically when the other channel recording is on, then that use case is supported by setting the DYN_CH_PUPD_EN, P0_R117_D4 register bit to 1'b1 but do not power-down channel 1 in this mode of operation.

The device supports an input signal bandwidth up to 80 kHz, which allows the high-frequency non-audio signal to be recorded by using a 176.4-kHz (or higher) sample rate.

For output sample rates of 48 kHz or lower, the device supports all features for 8-channel recording and various programmable processing blocks. However, for output sample rates higher than 48 kHz, there are limitations in the number of simultaneous channel recordings supported and the number of biquad filters and such. See the [PCM6xx0-Q1 Sampling Rates and Programmable Processing Blocks Supported application report](#) for further details.

8.3.8.1 Programmable Channel Gain and Digital Volume Control

The device has an independent programmable channel gain setting for each input channel that can be set to the appropriate value based on the maximum input signal expected in the system and the ADC VREF setting used (see the [Reference Voltage](#) section), which determines the ADC full-scale signal level.

Configure the desired channel gain setting before powering up the ADC channel and do not change this setting while the ADC is powered on. The programmable range supported for each channel gain is from 0 dB to 42 dB in steps of 1 dB. To achieve low-noise performance, the device internal logic first maximizes the gain for the front-end low-noise analog PGA, and then applies any residual programmed channel gain in the digital processing block.

Table 8-10 shows the programmable options available for the channel gain.

Table 8-10. Channel Gain Programmable Settings

| P0_R61_D[7:2] : CH1_GAIN[5:0] | CHANNEL GAIN SETTING FOR INPUT CHANNEL 1 |
|---------------------------------|--|
| 00 0000 = 0d (default) | Input channel 1 gain is set to 0 dB |
| 00 0001 = 1d | Input channel 1 gain is set to 1 dB |
| 00 0010 = 2d | Input channel 1 gain is set to 2 dB |
| ... | ... |
| 10 1001 = 41d | Input channel 1 gain is set to 41 dB |
| 10 1010 = 42d | Input channel 1 gain is set to 42 dB |
| 10 1011 to 11 1111 = 43d to 63d | Reserved (do not use these settings) |

Similarly, the channel gain setting for input channel 2 to channel 6 can be configured using the CH2_GAIN (P0_R66) to CH6_GAIN (P0_R86) register bits, respectively.

The device also has a programmable digital volume control with a range from –100 dB to 27 dB in steps of 0.5 dB with the option to mute the channel recording. The digital volume control value can be changed dynamically while the ADC channel is powered-up and recording. During volume control changes, the soft ramp-up or ramp-down volume feature is used internally to avoid any audible artifacts. Soft-stepping can be entirely disabled using the DISABLE_SOFT_STEP (P0_R108_D4) register bit.

The digital volume control setting is independently available for each output channel, including the digital microphone record channel. However, the device also supports an option to gang-up the volume control setting for all channels together using the channel 1 digital volume control setting, regardless if channel 1 is powered up or powered down. This gang-up can be enabled using the DVOL_GANG (P0_R108_D7) register bit.

Table 8-11 shows the programmable options available for the digital volume control.

Table 8-11. Digital Volume Control (DVC) Programmable Settings

| P0_R62_D[7:0] : CH1_DVOL[7:0] | DVC SETTING FOR OUTPUT CHANNEL 1 |
|-------------------------------|---|
| 0000 0000 = 0d | Output channel 1 DVC is set to mute |
| 0000 0001 = 1d | Output channel 1 DVC is set to –100 dB |
| 0000 0010 = 2d | Output channel 1 DVC is set to –99.5 dB |
| 0000 0011 = 3d | Output channel 1 DVC is set to –99 dB |
| ... | ... |
| 1100 1000 = 200d | Output channel 1 DVC is set to –0.5 dB |
| 1100 1001 = 201d (default) | Output channel 1 DVC is set to 0 dB |
| 1100 1010 = 202d | Output channel 1 DVC is set to 0.5 dB |
| ... | ... |
| 1111 1101 = 253d | Output channel 1 DVC is set to 26 dB |
| 1111 1110 = 254d | Output channel 1 DVC is set to 26.5 dB |
| 1111 1111 = 255d | Output channel 1 DVC is set to 27 dB |

Similarly, the digital volume control setting for output channel 2 to channel 6 can be configured using the CH2_DVOL (P0_R67) to CH6_DVOL (P0_R87) register bits, respectively.

The internal digital processing engine soft ramps up the volume from a muted level to the programmed volume level when the channel is powered up, and the internal digital processing engine soft ramps down the volume from a programmed volume to mute when the channel is powered down. This soft-stepping of volume is done to prevent abruptly powering up and powering down the record channel. This feature can also be entirely disabled using the DISABLE_SOFT_STEP (P0_R108_D4) register bit.

8.3.8.2 Programmable Channel Gain Calibration

Along with the programmable channel gain and digital volume, this device also provides programmable channel gain calibration. The gain of each channel can be finely calibrated or adjusted in steps of 0.1 dB for a range of –0.8-dB to 0.7-dB gain error. This adjustment is useful when trying to match the gain across channels resulting from external components and microphone sensitivity. This feature, in combination with the regular digital volume control, allows the gains across all channels to be matched for a wide gain error range with a resolution of 0.1 dB. Table 8-12 shows the programmable options available for the channel gain calibration.

Table 8-12. Channel Gain Calibration Programmable Settings

| P0_R63_D[7:4] : CH1_GCAL[3:0] | CHANNEL GAIN CALIBRATION SETTING FOR INPUT CHANNEL 1 |
|-------------------------------|--|
| 0000 = 0d | Input channel 1 gain calibration is set to –0.8 dB |
| 0001 = 1d | Input channel 1 gain calibration is set to –0.7 dB |
| ... | ... |
| 1000 = 8d (default) | Input channel 1 gain calibration is set to 0 dB |
| ... | ... |
| 1110 = 14d | Input channel 1 gain calibration is set to 0.6 dB |
| 1111 = 15d | Input channel 1 gain calibration is set to 0.7 dB |

Similarly, the channel gain calibration setting for input channel 2 to channel 6 can be configured using the CH2_GCAL (P0_R68) to CH6_GCAL (P0_R88) register bits, respectively.

8.3.8.3 Programmable Channel Phase Calibration

In addition to the gain calibration, the phase delay in each channel can be finely calibrated or adjusted in steps of one modulator clock cycle for a cycle range of 0 to 255 for the phase error. The modulator clock, the same clock used for ADC_MOD_CLK, is 6.144 MHz (the output data sample rate is multiples or submultiples of 48 kHz) or 5.6448 MHz (the output data sample rate is multiples or submultiples of 44.1 kHz). This feature is very useful for many applications that must match the phase with fine resolution between each channel, including any phase mismatch across channels resulting from external components or microphones. Table 8-13 shows the available programmable options for channel phase calibration.

Table 8-13. Channel Phase Calibration Programmable Settings

| P0_R64_D[7:0] : CH1_PCAL[7:0] | CHANNEL PHASE CALIBRATION SETTING FOR INPUT CHANNEL 1 |
|-------------------------------|---|
| 0000 0000 = 0d (default) | Input channel 1 phase calibration with no delay |
| 0000 0001 = 1d | Input channel 1 phase calibration delay is set to one cycle of the modulator clock |
| 0000 0010 = 2d | Input channel 1 phase calibration delay is set to two cycles of the modulator clock |
| ... | ... |
| 1111 1110 = 254d | Input channel 1 phase calibration delay is set to 254 cycles of the modulator clock |
| 1111 1111 = 255d | Input channel 1 phase calibration delay is set to 255 cycles of the modulator clock |

Similarly, the channel phase calibration setting for input channel 2 to channel 6 can be configured using the CH2_PCAL (P0_R69) to CH6_PCAL (P0_R89) register bits, respectively.

8.3.8.4 Programmable Digital High-Pass Filter

To remove the DC offset component and attenuate the undesired low-frequency noise content in the record data, the device supports a programmable high-pass filter (HPF). The HPF is not a channel-independent filter setting but is globally applicable for all ADC channels. This HPF is constructed using the first-order infinite impulse response (IIR) filter, and is efficient enough to filter out possible DC components of the signal. Table 8-14 shows the predefined –3-dB cutoff frequencies available that can be set by using the HPF_SEL[1:0] register bits of P0_R107. Additionally, to achieve a custom –3-dB cutoff frequency for a specific application, the device also allows the first-order IIR filter coefficients to be programmed when the HPF_SEL[1:0] register bits are set to 2'b00. Figure 8-23 illustrates a frequency response plot for the HPF filter.

Table 8-14. HPF Programmable Settings

| P0_R107_D[1:0] : HPF_SEL[1:0] | -3-dB CUTOFF FREQUENCY SETTING | -3-dB CUTOFF FREQUENCY AT 16-kHz SAMPLE RATE | -3-dB CUTOFF FREQUENCY AT 48-kHz SAMPLE RATE |
|-------------------------------|-----------------------------------|--|--|
| 00 | Programmable 1st-order IIR filter | Programmable 1st-order IIR filter | Programmable 1st-order IIR filter |
| 01 (default) | $0.00025 \times f_s$ | 4 Hz | 12 Hz |
| 10 | $0.002 \times f_s$ | 32 Hz | 96 Hz |
| 11 | $0.008 \times f_s$ | 128 Hz | 384 Hz |

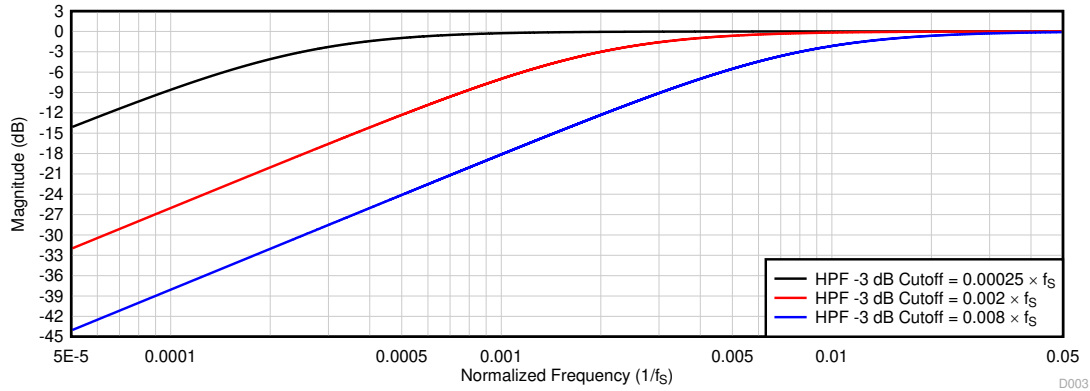

Figure 8-23. HPF Filter Frequency Response Plot

Equation 1 gives the transfer function for the first-order programmable IIR filter:

$$H(z) = \frac{N_0 + N_1 z^{-1}}{2^{31} - D_1 z^{-1}} \quad (1)$$

The frequency response for this first-order programmable IIR filter with default coefficients is flat at a gain of 0 dB (all-pass filter). The host device can override the frequency response by programming the IIR coefficients in Table 8-15 to achieve the desired frequency response for high-pass filtering or any other desired filtering. If HPF_SEL[1:0] are set to 2'b00, the host device must write these coefficients values for the desired frequency response before powering-up any ADC channel for recording. These programmable coefficients are 32-bit, two's complement numbers. Table 8-15 shows the filter coefficients for the first-order IIR filter.

Table 8-15. 1st-Order IIR Filter Coefficients

| FILTER | FILTER COEFFICIENT | DEFAULT COEFFICIENT VALUE | COEFFICIENT REGISTER MAPPING |
|---|--------------------|---------------------------|------------------------------|
| Programmable 1st-order IIR filter (can be allocated to HPF or any other desired filter) | N ₀ | 0x7FFFFFFF | P4_R72-R75 |
| | N ₁ | 0x00000000 | P4_R76-R79 |
| | D ₁ | 0x00000000 | P4_R80-R83 |

8.3.8.5 Programmable Digital Biquad Filters

The device supports up to 12 programmable digital biquad filters. These highly efficient filters achieve the desired frequency response. In digital signal processing, a digital biquad filter is a second-order, recursive linear filter with two poles and two zeros. Equation 2 gives the transfer function of each biquad filter:

$$H(z) = \frac{N_0 + 2N_1 z^{-1} + N_2 z^{-2}}{2^{31} - 2D_1 z^{-1} - D_2 z^{-2}} \quad (2)$$

The frequency response for the biquad filter section with default coefficients is flat at a gain of 0 dB (all-pass filter). The host device can override the frequency response by programming the biquad coefficients to achieve the desired frequency response for a low-pass, high-pass, or any other desired frequency shaping. The programmable coefficients for the mixer operation are located in the Programmable Coefficient Registers: Page 2 and Programmable Coefficient Registers: Page 3 sections. If biquad filtering is required, then the host device must write these coefficients values before powering up any ADC channels for recording. These programmable coefficients are 32-bit, two's complement numbers. As described in Table 8-16, these biquad filters can be allocated for each output channel based on the BIQUAD_CFG[1:0] register setting of P0_R108. By setting BIQUAD_CFG[1:0] to 2'b00, the biquad filtering for all record channels is disabled and the host device can choose this setting if no additional filtering is required for the system application. See the PCM6xx0-Q1 Programmable Biquad Filter Configuration and Applications application report for further details.

Table 8-16. Biquad Filter Allocation to the Record Output Channel

| PROGRAMMABLE BIQUAD FILTER | RECORD OUTPUT CHANNEL ALLOCATION USING P0_R108_D[6:5] REGISTER SETTING | | |
|----------------------------|--|--|--|
| | BIQUAD_CFG[1:0] = 2'b01 (1 Biquad per Channel) | BIQUAD_CFG[1:0] = 2'b10 (Default) (2 Biquads per Channel) | BIQUAD_CFG[1:0] = 2'b11 (3 Biquads per Channel) |
| | SUPPORTS ALL 8 CHANNELS | SUPPORTS UP TO 6 CHANNELS | SUPPORTS UP TO 4 CHANNELS |
| Biquad filter 1 | Allocated to output channel 1 | Allocated to output channel 1 | Allocated to output channel 1 |
| Biquad filter 2 | Allocated to output channel 2 | Allocated to output channel 2 | Allocated to output channel 2 |
| Biquad filter 3 | Allocated to output channel 3 | Allocated to output channel 3 | Allocated to output channel 3 |
| Biquad filter 4 | Allocated to output channel 4 | Allocated to output channel 4 | Allocated to output channel 4 |
| Biquad filter 5 | Not used | Allocated to output channel 1 | Allocated to output channel 1 |
| Biquad filter 6 | Not used | Allocated to output channel 2 | Allocated to output channel 2 |
| Biquad filter 7 | Not used | Allocated to output channel 3 | Allocated to output channel 3 |
| Biquad filter 8 | Not used | Allocated to output channel 4 | Allocated to output channel 4 |
| Biquad filter 9 | Allocated to output channel 5 | Allocated to output channel 5 | Allocated to output channel 1 |
| Biquad filter 10 | Allocated to output channel 6 | Allocated to output channel 6 | Allocated to output channel 2 |
| Biquad filter 11 | Not used | Allocated to output channel 5 | Allocated to output channel 3 |
| Biquad filter 12 | Not used | Allocated to output channel 6 | Allocated to output channel 4 |

Table 8-17 shows the biquad filter coefficients mapping to the register space.

Table 8-17. Biquad Filter Coefficients Register Mapping

| PROGRAMMABLE BIQUAD FILTER | BIQUAD FILTER COEFFICIENTS REGISTER MAPPING | PROGRAMMABLE BIQUAD FILTER | BIQUAD FILTER COEFFICIENTS REGISTER MAPPING |
|----------------------------|---|----------------------------|---|
| Biquad filter 1 | P2_R8-R27 | Biquad filter 7 | P3_R8-R27 |
| Biquad filter 2 | P2_R28-R47 | Biquad filter 8 | P3_R28-R47 |
| Biquad filter 3 | P2_R48-R67 | Biquad filter 9 | P3_R48-R67 |
| Biquad filter 4 | P2_R68-R87 | Biquad filter 10 | P3_R68-R87 |
| Biquad filter 5 | P2_R88-R107 | Biquad filter 11 | P3_R88-R107 |
| Biquad filter 6 | P2_R108-R127 | Biquad filter 12 | P3_R108-R127 |

8.3.8.6 Programmable Channel Summer and Digital Mixer

For applications that require an even higher SNR than that supported for each channel, the device digital summing mode can be used. In this mode, the digital record data are summed up across the channel with an equal weightage factor, which helps in reducing the effective record noise. Table 8-18 lists the configuration settings available for channel summing mode.

Table 8-18. Channel Summing Mode Programmable Settings

| P0_R107_D[3:2] : CH_SUM[2:0] | CHANNEL SUMMING MODE FOR INPUT CHANNELS | SNR AND DYNAMIC RANGE BOOST |
|------------------------------|--|-------------------------------------|
| 00 (Default) | Channel summing mode is disabled | Not applicable |
| 01 | Output channel 1 = (input channel 1 + input channel 2) / 2 | 3-dB boost in SNR and dynamic range |
| | Output channel 2 = (input channel 1 + input channel 2) / 2 | |
| | Output channel 3 = (input channel 3 + input channel 4) / 2 | 3-dB boost in SNR and dynamic range |
| | Output channel 4 = (input channel 3 + input channel 4) / 2 | |
| 10 | Output channel 1 = (input channel 1 + input channel 2 + input channel 3 + input channel 4) / 4 | 6-dB boost in SNR and dynamic range |
| | Output channel 2 = (input channel 1 + input channel 2 + input channel 3 + input channel 4) / 4 | |
| | Output channel 3 = (input channel 1 + input channel 2 + input channel 3 + input channel 4) / 4 | |
| | Output channel 4 = (input channel 1 + input channel 2 + input channel 3 + input channel 4) / 4 | |
| 11 | Reserved (do not use this setting) | Not applicable |

The device additionally supports a fully programmable mixer feature that can mix the various input channels with their custom programmable scale factor to generate the final output channels. The programmable mixer feature is available only if CH_SUM[2:0] is set to 2'b00. The mixer function is only supported for input channel 1 to channel 4. Figure 8-24 shows a block diagram that describes the mixer 1 operation to generate output channel 1. The programmable coefficients for the mixer operation are located in the *Programmable Coefficient Registers: Page 4* section. All mixer coefficients are 32-bit, two's complement numbers using a 1.31 number format. The value of 0x7FFFFFFF is equivalent to +1 (0-dB gain), the value 0x00000000 is equivalent to mute (zero data), and any values in between set the mixer attenuation computed using Equation 3. If the MSB is set to '1' then the attenuation remains the same but the signal phase is inverted.

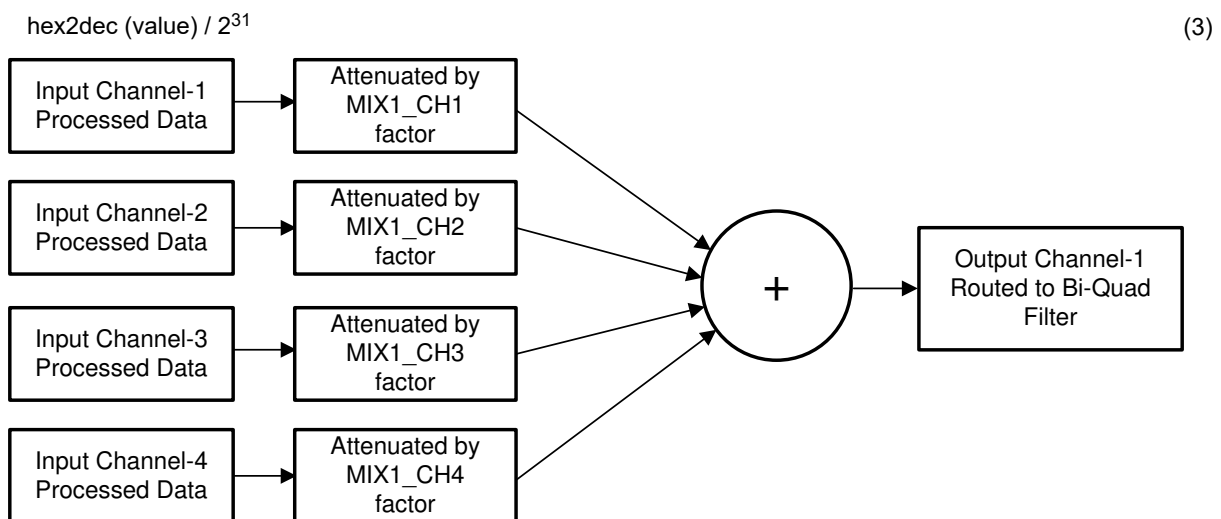

Figure 8-24. Programmable Digital Mixer Block Diagram

A similar mixer operation is performed by mixer 2, mixer 3, and mixer 4 to generate output channel 2, channel 3, and channel 4, respectively.

8.3.8.7 Configurable Digital Decimation Filters

The device record channel includes a high dynamic range, built-in digital decimation filter to process the oversampled data from the multibit delta-sigma ($\Delta\Sigma$) modulator to generate digital data at the same Nyquist sampling rate as the FSYNC rate. The decimation filter can be chosen from three different types, depending on the required frequency response, group delay, and phase linearity requirements for the target application. The selection of the decimation filter option can be done by configuring the DECI_FILT, P0_R107_D[5:4] register bits. [Table 8-19](#) shows the configuration register setting for the decimation filter mode selection for the record channel.

Table 8-19. Decimation Filter Mode Selection for the Record Channel

| P0_R107_D[5:4] : DECI_FILT[1:0] | DECIMATION FILTER MODE SELECTION |
|---------------------------------|---|
| 00 (default) | Linear phase filters are used for the decimation |
| 01 | Low-latency filters are used for the decimation |
| 10 | Ultra-low latency filters are used for the decimation |
| 11 | Reserved (do not use this setting) |

8.3.8.7.1 Linear Phase Filters

The linear phase decimation filters are the default filters set by the device and can be used for all applications that require a perfect linear phase with zero-phase deviation within the pass-band specification of the filter. The filter performance specifications and various plots for all supported output sampling rates are listed in this section.

8.3.8.7.1.1 Sampling Rate: 8 kHz or 7.35 kHz

[Figure 8-25](#) and [Figure 8-26](#) respectively show the magnitude response and the pass-band ripple for a decimation filter with a sampling rate of 8 kHz or 7.35 kHz. [Table 8-20](#) lists the specifications for a decimation filter with an 8-kHz or 7.35-kHz sampling rate.

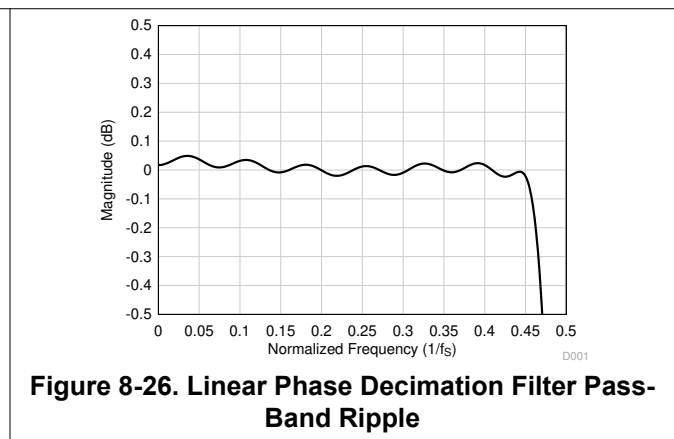
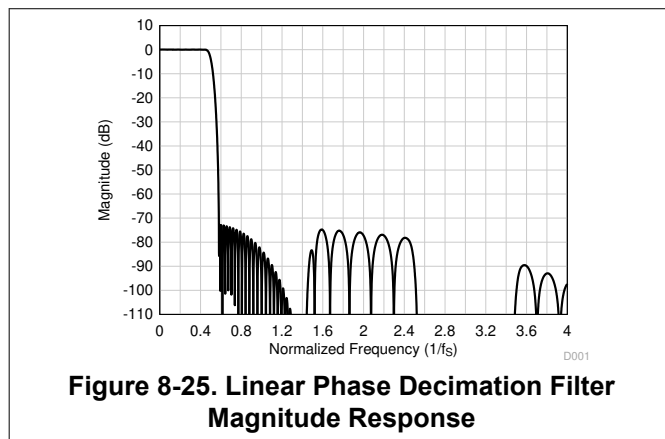

Table 8-20. Linear Phase Decimation Filter Specifications

| PARAMETER | TEST CONDITIONS | MIN | TYP | MAX | UNIT |
|------------------------|--|-------|------|------|---------|
| Pass-band ripple | Frequency range is 0 to $0.454 \times f_s$ | -0.05 | | 0.05 | dB |
| Stop-band attenuation | Frequency range is $0.58 \times f_s$ to $4 \times f_s$ | 72.7 | | | dB |
| | Frequency range is $4 \times f_s$ onwards | 81.2 | | | |
| Group delay or latency | Frequency range is 0 to $0.454 \times f_s$ | | 17.1 | | $1/f_s$ |

8.3.8.7.1.2 Sampling Rate: 16 kHz or 14.7 kHz

Figure 8-27 and Figure 8-28 respectively show the magnitude response and the pass-band ripple for a decimation filter with a sampling rate of 16 kHz or 14.7 kHz. Table 8-21 lists the specifications for a decimation filter with an 16-kHz or 14.7-kHz sampling rate.

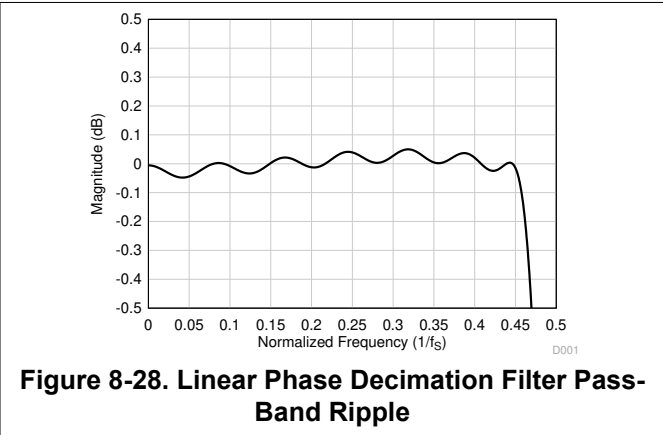
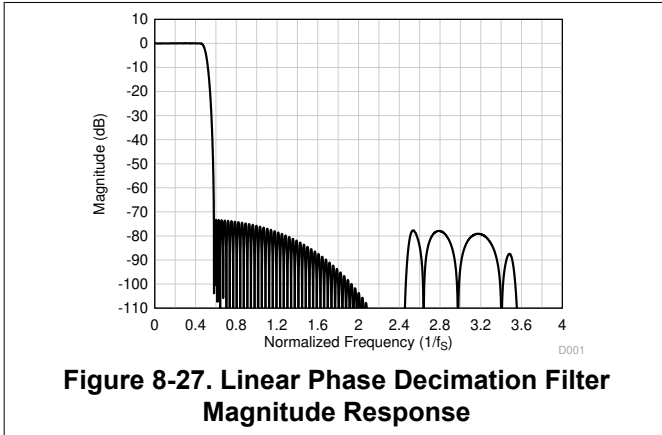

Table 8-21. Linear Phase Decimation Filter Specifications

| PARAMETER | TEST CONDITIONS | MIN | TYP | MAX | UNIT |
|------------------------|--|-------|------|------|---------|
| Pass-band ripple | Frequency range is 0 to $0.454 \times f_s$ | -0.05 | | 0.05 | dB |
| Stop-band attenuation | Frequency range is $0.58 \times f_s$ to $4 \times f_s$ | 73.3 | | | dB |
| | Frequency range is $4 \times f_s$ onwards | 95.0 | | | |
| Group delay or latency | Frequency range is 0 to $0.454 \times f_s$ | | 15.7 | | $1/f_s$ |

8.3.8.7.1.3 Sampling Rate: 24 kHz or 22.05 kHz

Figure 8-29 and Figure 8-30 respectively show the magnitude response and the pass-band ripple for a decimation filter with a sampling rate of 24 kHz or 22.05 kHz. Table 8-22 lists the specifications for a decimation filter with an 24-kHz or 22.05-kHz sampling rate.

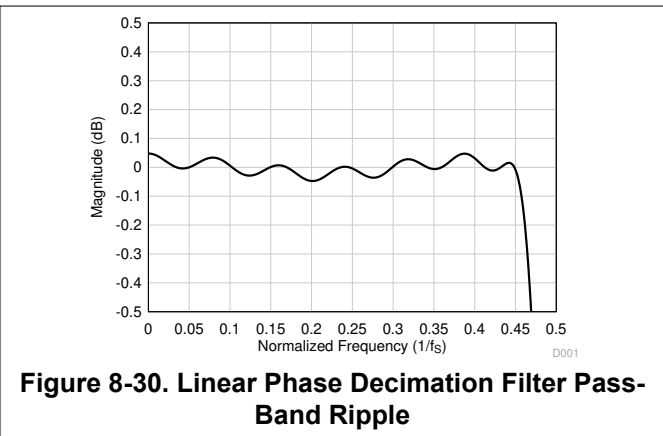
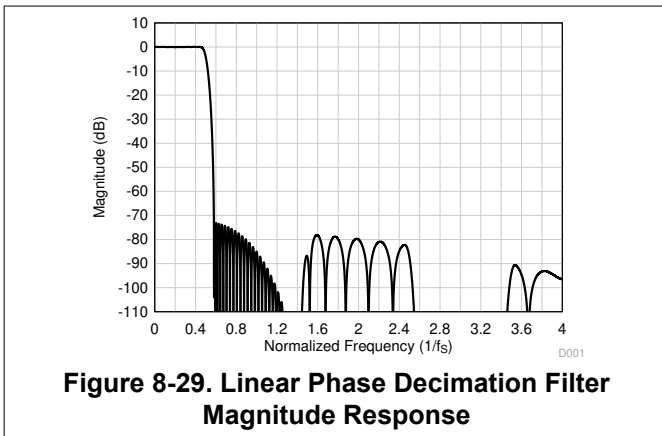

Table 8-22. Linear Phase Decimation Filter Specifications

| PARAMETER | TEST CONDITIONS | MIN | TYP | MAX | UNIT |
|------------------------|--|-------|------|------|---------|
| Pass-band ripple | Frequency range is 0 to $0.454 \times f_S$ | -0.05 | | 0.05 | dB |
| Stop-band attenuation | Frequency range is $0.58 \times f_S$ to $4 \times f_S$ | 73.0 | | | dB |
| | Frequency range is $4 \times f_S$ onwards | 96.4 | | | |
| Group delay or latency | Frequency range is 0 to $0.454 \times f_S$ | | 16.6 | | $1/f_S$ |

8.3.8.7.1.4 Sampling Rate: 32 kHz or 29.4 kHz

Figure 8-31 and Figure 8-32 respectively show the magnitude response and the pass-band ripple for a decimation filter with a sampling rate of 32 kHz or 29.4 kHz. Table 8-23 lists the specifications for a decimation filter with an 32-kHz or 29.4-kHz sampling rate.

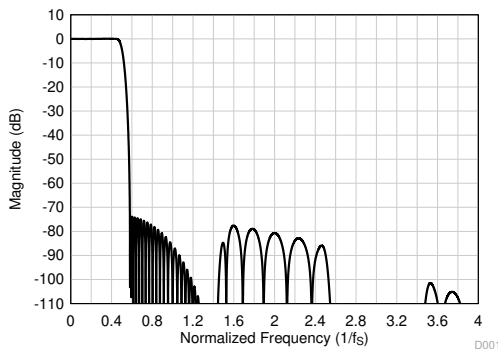

Figure 8-31. Linear Phase Decimation Filter Magnitude Response

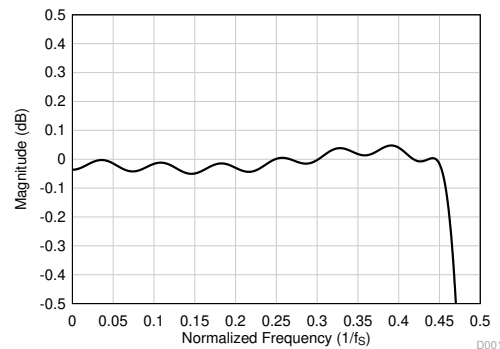

Figure 8-32. Linear Phase Decimation Filter Pass-Band Ripple

Table 8-23. Linear Phase Decimation Filter Specifications

| PARAMETER | TEST CONDITIONS | MIN | TYP | MAX | UNIT |
|------------------------|--|-------|------|------|---------|
| Pass-band ripple | Frequency range is 0 to $0.454 \times f_S$ | -0.05 | | 0.05 | dB |
| Stop-band attenuation | Frequency range is $0.58 \times f_S$ to $4 \times f_S$ | 73.7 | | | dB |
| | Frequency range is $4 \times f_S$ onwards | 107.2 | | | |
| Group delay or latency | Frequency range is 0 to $0.454 \times f_S$ | | 16.9 | | $1/f_S$ |

8.3.8.7.1.5 Sampling Rate: 48 kHz or 44.1 kHz

Figure 8-33 and Figure 8-34 respectively show the magnitude response and the pass-band ripple for a decimation filter with a sampling rate of 48 kHz or 44.1 kHz. Table 8-24 lists the specifications for a decimation filter with an 48-kHz or 44.1-kHz sampling rate.

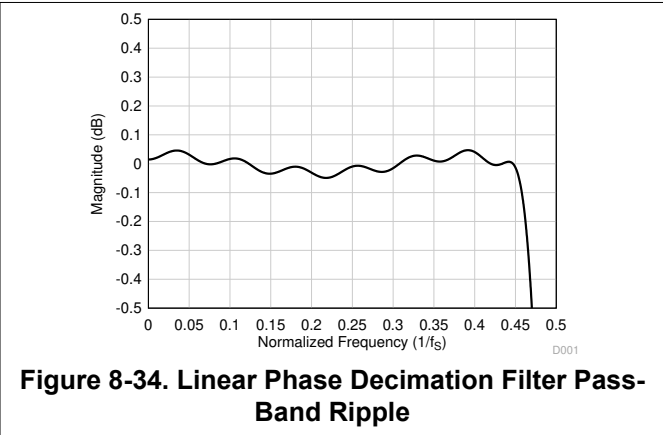
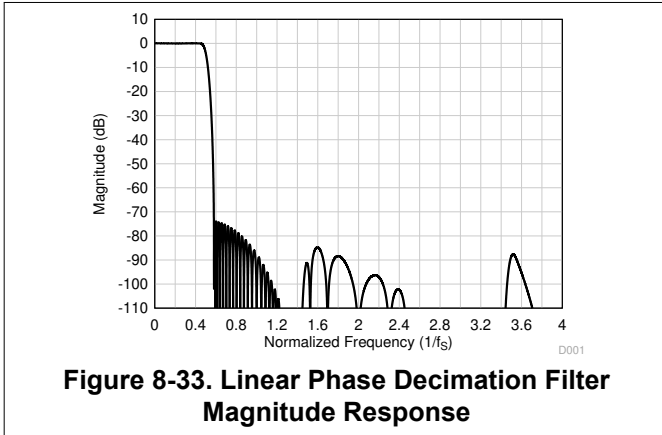

Table 8-24. Linear Phase Decimation Filter Specifications

| PARAMETER | TEST CONDITIONS | MIN | TYP | MAX | UNIT |
|------------------------|--|-------|------|------|---------|
| Pass-band ripple | Frequency range is 0 to $0.454 \times f_s$ | -0.05 | | 0.05 | dB |
| Stop-band attenuation | Frequency range is $0.58 \times f_s$ to $4 \times f_s$ | 73.8 | | | |
| | Frequency range is $4 \times f_s$ onwards | 98.1 | | | |
| Group delay or latency | Frequency range is 0 to $0.454 \times f_s$ | | 17.1 | | $1/f_s$ |

8.3.8.7.1.6 Sampling Rate: 96 kHz or 88.2 kHz

Figure 8-35 and Figure 8-36 respectively show the magnitude response and the pass-band ripple for a decimation filter with a sampling rate of 96 kHz or 88.2 kHz. Table 8-25 lists the specifications for a decimation filter with an 96-kHz or 88.2-kHz sampling rate.

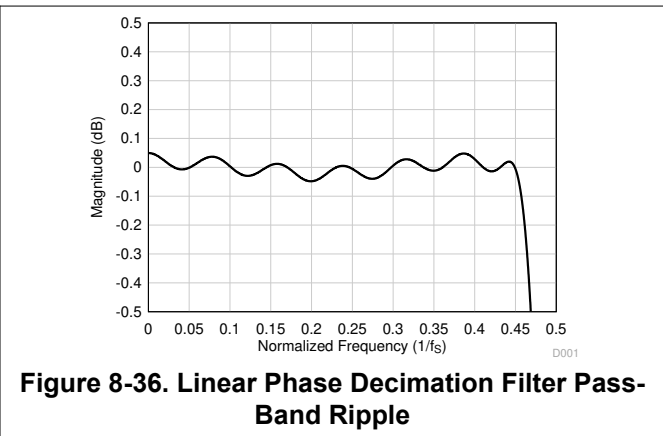
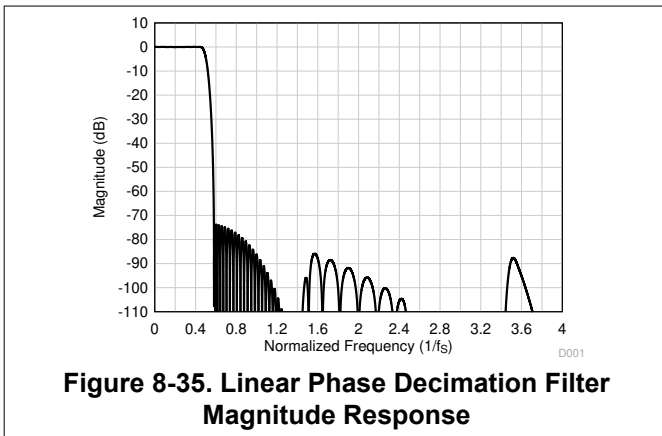

Table 8-25. Linear Phase Decimation Filter Specifications

| PARAMETER | TEST CONDITIONS | MIN | TYP | MAX | UNIT |
|------------------------|--|-------|------|------|---------|
| Pass-band ripple | Frequency range is 0 to $0.454 \times f_S$ | -0.05 | | 0.05 | dB |
| Stop-band attenuation | Frequency range is $0.58 \times f_S$ to $4 \times f_S$ | 73.6 | | | dB |
| | Frequency range is $4 \times f_S$ onwards | 97.9 | | | |
| Group delay or latency | Frequency range is 0 to $0.454 \times f_S$ | | 17.1 | | $1/f_S$ |

8.3.8.7.1.7 Sampling Rate: 192 kHz or 176.4 kHz

Figure 8-37 and Figure 8-38 respectively show the magnitude response and the pass-band ripple for a decimation filter with a sampling rate of 192 kHz or 176.4 kHz. Table 8-26 lists the specifications for a decimation filter with an 192-kHz or 176.4-kHz sampling rate.

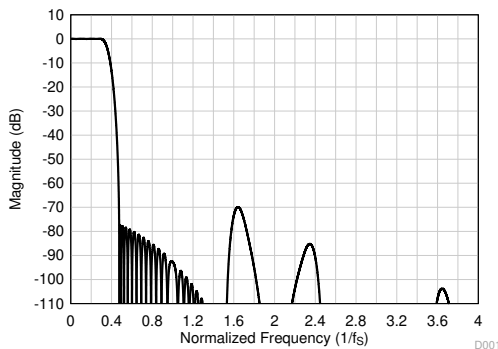

Figure 8-37. Linear Phase Decimation Filter Magnitude Response

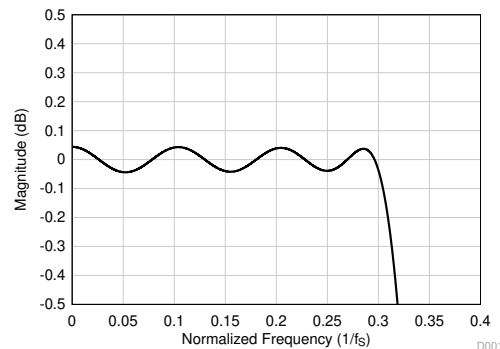

Figure 8-38. Linear Phase Decimation Filter Pass-Band Ripple

Table 8-26. Linear Phase Decimation Filter Specifications

| PARAMETER | TEST CONDITIONS | MIN | TYP | MAX | UNIT |
|------------------------|---|-------|------|------|---------|
| Pass-band ripple | Frequency range is 0 to $0.3 \times f_S$ | -0.05 | | 0.05 | dB |
| Stop-band attenuation | Frequency range is $0.473 \times f_S$ to $4 \times f_S$ | 70.0 | | | dB |
| | Frequency range is $4 \times f_S$ onwards | 111.0 | | | |
| Group delay or latency | Frequency range is 0 to $0.3 \times f_S$ | | 11.9 | | $1/f_S$ |

8.3.8.7.1.8 Sampling Rate: 384 kHz or 352.8 kHz

Figure 8-39 and Figure 8-40 respectively show the magnitude response and the pass-band ripple for a decimation filter with a sampling rate of 384 kHz or 352.8 kHz. Table 8-27 lists the specifications for a decimation filter with an 384-kHz or 352.8-kHz sampling rate.

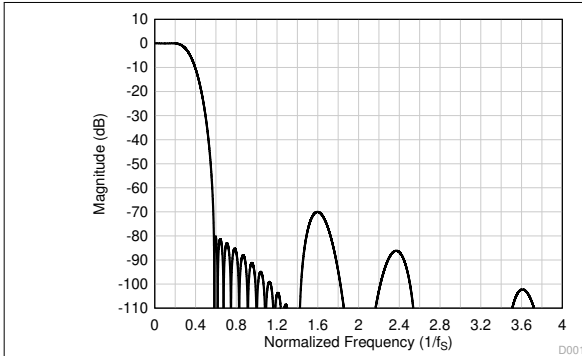

Figure 8-39. Linear Phase Decimation Filter Magnitude Response

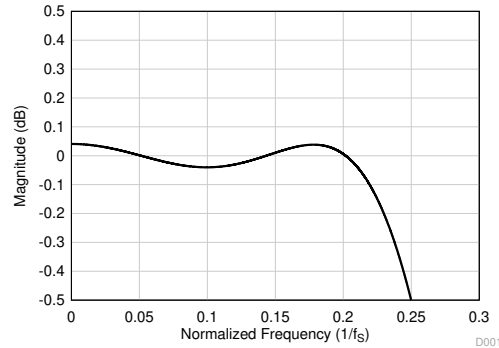

Figure 8-40. Linear Phase Decimation Filter Pass-Band Ripple

Table 8-27. Linear Phase Decimation Filter Specifications

| PARAMETER | TEST CONDITIONS | MIN | TYP | MAX | UNIT |
|------------------------|--|-------|-----|------|---------|
| Pass-band ripple | Frequency range is 0 to $0.212 \times f_s$ | -0.05 | | 0.05 | dB |
| Stop-band attenuation | Frequency range is $0.58 \times f_s$ to $4 \times f_s$ | 70.0 | | | dB |
| | Frequency range is $4 \times f_s$ onwards | 108.8 | | | |
| Group delay or latency | Frequency range is 0 to $0.212 \times f_s$ | | 7.2 | | $1/f_s$ |

8.3.8.7.1.9 Sampling Rate: 768 kHz or 705.6 kHz

Figure 8-41 and Figure 8-42 respectively show the magnitude response and the pass-band ripple for a decimation filter with a sampling rate of 768 kHz or 705.6 kHz. Table 8-28 lists the specifications for a decimation filter with an 768-kHz or 705.6-kHz sampling rate.

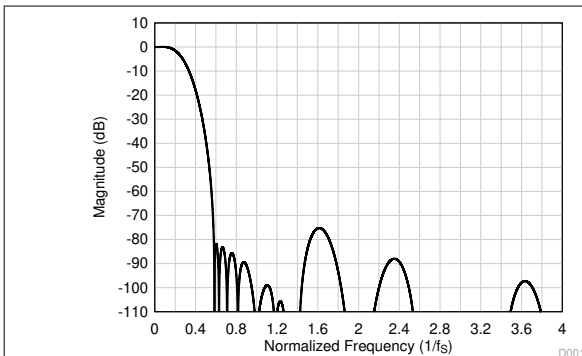

Figure 8-41. Linear Phase Decimation Filter Magnitude Response

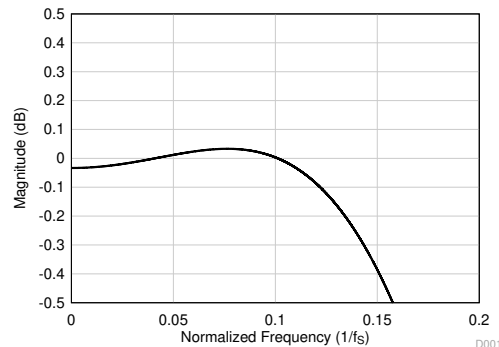

Figure 8-42. Linear Phase Decimation Filter Pass-Band Ripple

Table 8-28. Linear Phase Decimation Filter Specifications

| PARAMETER | TEST CONDITIONS | MIN | TYP | MAX | UNIT |
|------------------------|--|-------|-----|------|---------|
| Pass-band ripple | Frequency range is 0 to $0.113 \times f_s$ | -0.05 | | 0.05 | dB |
| Stop-band attenuation | Frequency range is $0.58 \times f_s$ to $2 \times f_s$ | 75.0 | | | dB |
| | Frequency range is $2 \times f_s$ onwards | 88.0 | | | |
| Group Delay or Latency | Frequency range is 0 to $0.113 \times f_s$ | | 5.9 | | $1/f_s$ |

8.3.8.7.2 Low-Latency Filters

For applications where low latency with minimal phase deviation (within the audio band) is critical, the low-latency decimation filters on the PCM6480-Q1 can be used. The device supports these filters with a group delay of approximately seven samples with an almost linear phase response within the $0.365 \times f_S$ frequency band. This section provides the filter performance specifications and various plots for all supported output sampling rates for the low-latency filters.

8.3.8.7.2.1 Sampling Rate: 16 kHz or 14.7 kHz

Figure 8-43 shows the magnitude response and Figure 8-44 shows the pass-band ripple and phase deviation for a decimation filter with a sampling rate of 16 kHz or 14.7 kHz. Table 8-29 lists the specifications for a decimation filter with a 16-kHz or 14.7-kHz sampling rate.

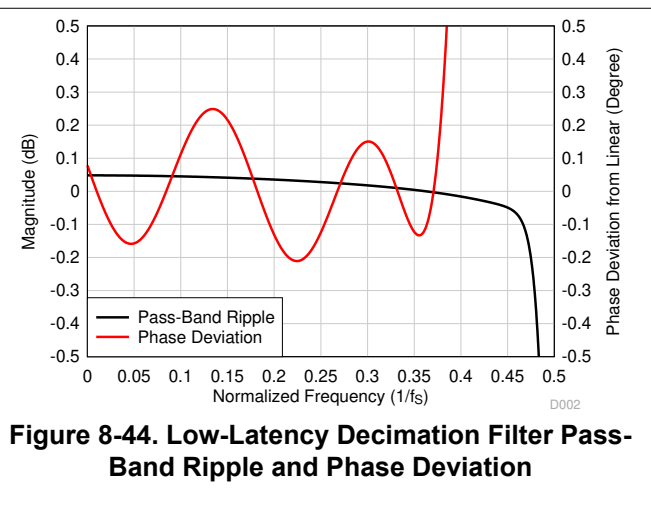
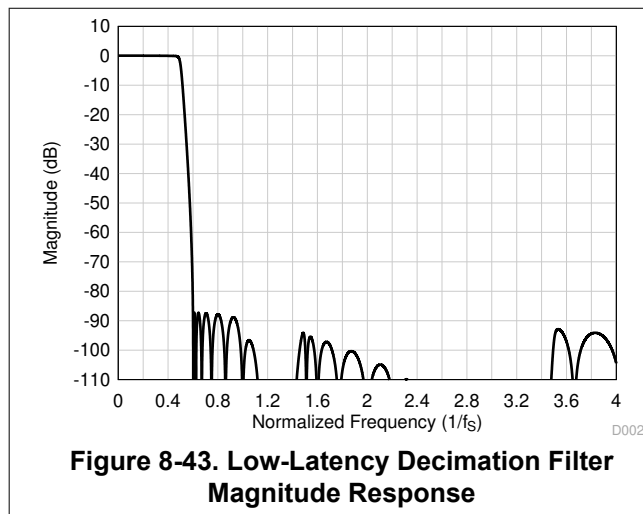

Table 8-29. Low-Latency Decimation Filter Specifications

| PARAMETER | TEST CONDITIONS | MIN | TYP | MAX | UNIT |
|------------------------|--|--------|-----|-------|---------|
| Pass-band ripple | Frequency range is 0 to $0.451 \times f_S$ | -0.05 | | 0.05 | dB |
| Stop-band attenuation | Frequency range is $0.61 \times f_S$ onwards | 87.3 | | | dB |
| Group delay or latency | Frequency range is 0 to $0.363 \times f_S$ | | 7.6 | | $1/f_S$ |
| Group delay deviation | Frequency range is 0 to $0.363 \times f_S$ | -0.022 | | 0.022 | $1/f_S$ |
| Phase deviation | Frequency range is 0 to $0.363 \times f_S$ | -0.21 | | 0.25 | Degrees |

8.3.8.7.2.2 Sampling Rate: 24 kHz or 22.05 kHz

Figure 8-45 shows the magnitude response and Figure 8-46 shows the pass-band ripple and phase deviation for a decimation filter with a sampling rate of 24 kHz or 22.05 kHz. Table 8-30 lists the specifications for a decimation filter with a 24-kHz or 22.05-kHz sampling rate.

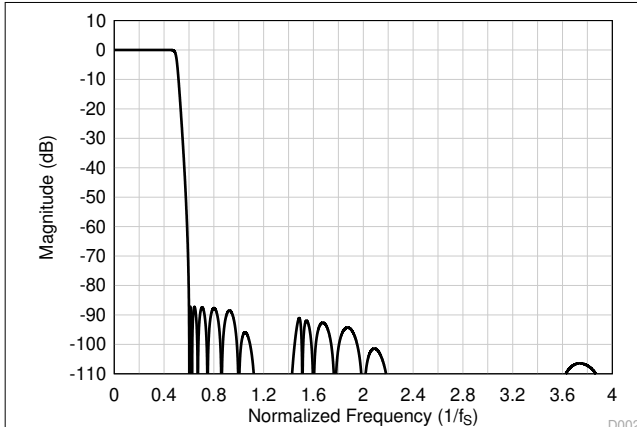

Figure 8-45. Low-Latency Decimation Filter Magnitude Response

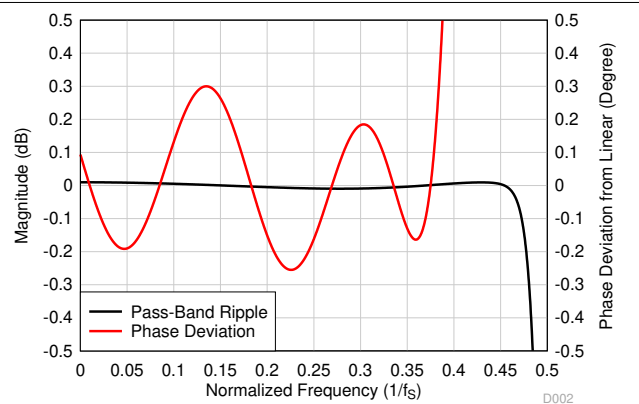

Figure 8-46. Low-Latency Decimation Filter Pass-Band Ripple and Phase Deviation

Table 8-30. Low-Latency Decimation Filter Specifications

| PARAMETER | TEST CONDITIONS | MIN | TYP | MAX | UNIT |
|------------------------|---|--------|-----|-------|---------|
| Pass-band ripple | Frequency range is 0 to $0.459 \times f_s$ | -0.01 | | 0.01 | dB |
| Stop-band attenuation | Frequency range is $0.6 \times f_s$ onwards | 87.2 | | | dB |
| Group delay or latency | Frequency range is 0 to $0.365 \times f_s$ | | 7.5 | | $1/f_s$ |
| Group delay deviation | Frequency range is 0 to $0.365 \times f_s$ | -0.026 | | 0.026 | $1/f_s$ |
| Phase deviation | Frequency range is 0 to $0.365 \times f_s$ | -0.26 | | 0.30 | Degrees |

8.3.8.7.2.3 Sampling Rate: 32 kHz or 29.4 kHz

Figure 8-47 shows the magnitude response and Figure 8-48 shows the pass-band ripple and phase deviation for a decimation filter with a sampling rate of 32 kHz or 29.4 kHz. Table 8-31 lists the specifications for a decimation filter with a 32-kHz or 29.4-kHz sampling rate.

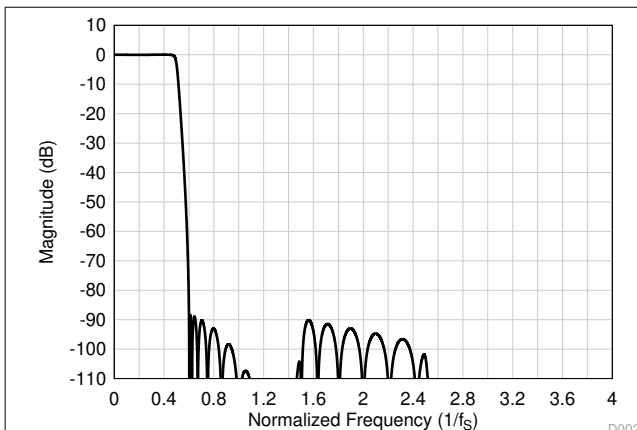

Figure 8-47. Low-Latency Decimation Filter Magnitude Response

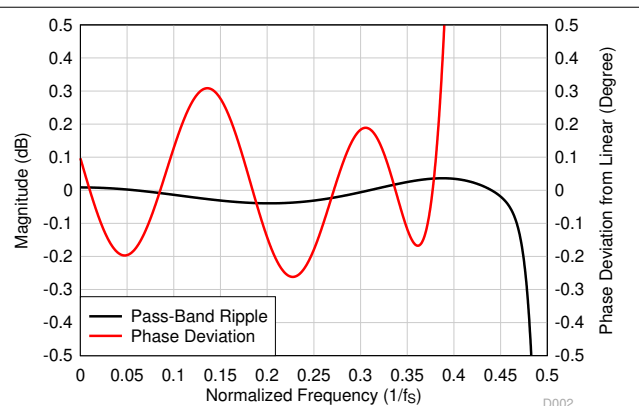

Figure 8-48. Low-Latency Decimation Filter Pass-Band Ripple and Phase Deviation

Table 8-31. Low-Latency Decimation Filter Specifications

| PARAMETER | TEST CONDITIONS | MIN | TYP | MAX | UNIT |
|------------------------|---|--------|-----|-------|---------|
| Pass-band ripple | Frequency range is 0 to $0.457 \times f_S$ | -0.04 | | 0.04 | dB |
| Stop-band attenuation | Frequency range is $0.6 \times f_S$ onwards | 88.3 | | | dB |
| Group delay or latency | Frequency range is 0 to $0.368 \times f_S$ | | 8.7 | | $1/f_S$ |
| Group delay deviation | Frequency range is 0 to $0.368 \times f_S$ | -0.026 | | 0.026 | $1/f_S$ |
| Phase deviation | Frequency range is 0 to $0.368 \times f_S$ | -0.26 | | 0.31 | Degrees |

8.3.8.7.2.4 Sampling Rate: 48 kHz or 44.1 kHz

Figure 8-49 shows the magnitude response and Figure 8-50 shows the pass-band ripple and phase deviation for a decimation filter with a sampling rate of 48 kHz or 44.1 kHz. Table 8-32 lists the specifications for a decimation filter with a 48-kHz or 44.1-kHz sampling rate.

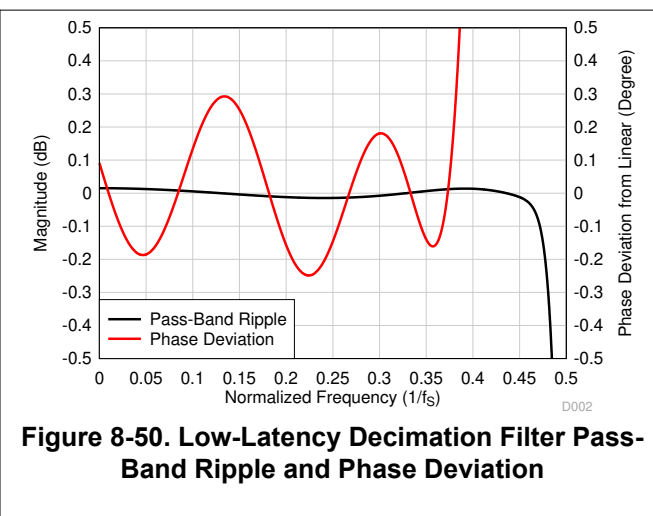
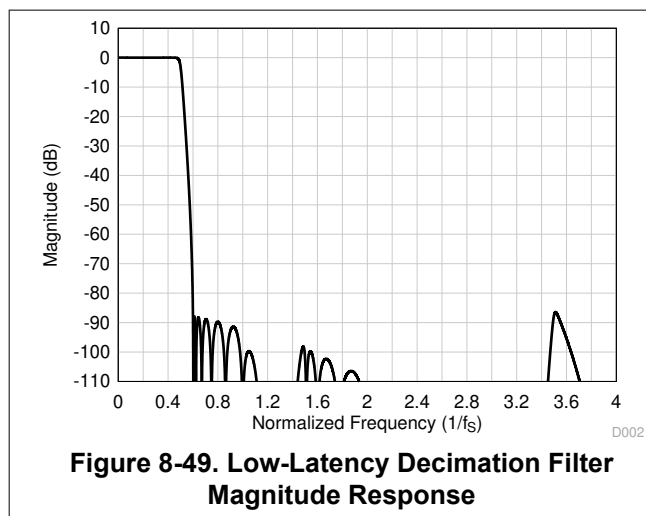

Table 8-32. Low-Latency Decimation Filter Specifications

| PARAMETER | TEST CONDITIONS | MIN | TYP | MAX | UNIT |
|------------------------|---|--------|-----|-------|---------|
| Pass-band ripple | Frequency range is 0 to $0.452 \times f_S$ | -0.015 | | 0.015 | dB |
| Stop-band attenuation | Frequency range is $0.6 \times f_S$ onwards | 86.4 | | | dB |
| Group delay or latency | Frequency range is 0 to $0.365 \times f_S$ | | 7.7 | | $1/f_S$ |
| Group delay deviation | Frequency range is 0 to $0.365 \times f_S$ | -0.027 | | 0.027 | $1/f_S$ |
| Phase deviation | Frequency range is 0 to $0.365 \times f_S$ | -0.25 | | 0.30 | Degrees |

8.3.8.7.2.5 Sampling Rate: 96 kHz or 88.2 kHz

Figure 8-51 shows the magnitude response and Figure 8-52 shows the pass-band ripple and phase deviation for a decimation filter with a sampling rate of 96 kHz or 88.2 kHz. Table 8-33 lists the specifications for a decimation filter with a 96-kHz or 88.2-kHz sampling rate.

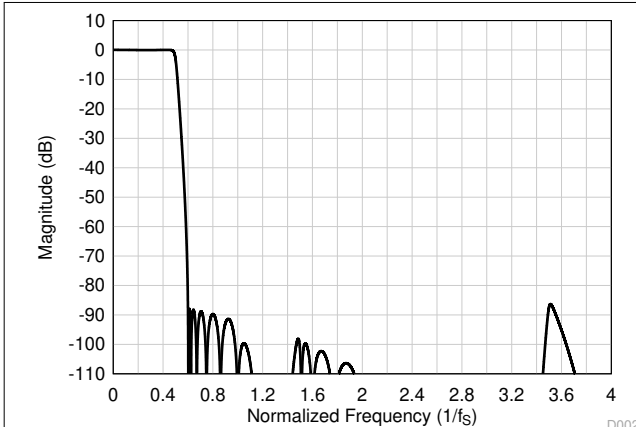

Figure 8-51. Low-Latency Decimation Filter Magnitude Response

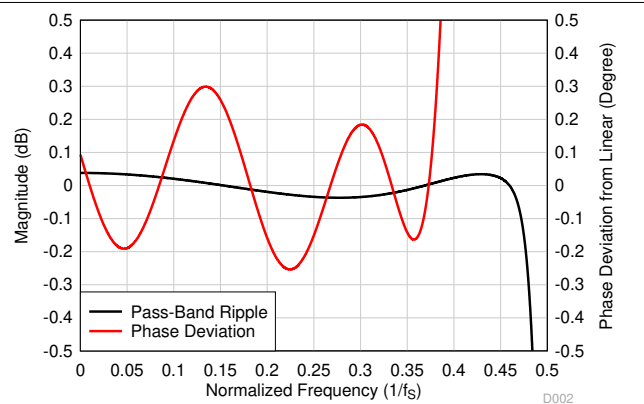

Figure 8-52. Low-Latency Decimation Filter Pass-Band Ripple and Phase Deviation

Table 8-33. Low-Latency Decimation Filter Specifications

| PARAMETER | TEST CONDITIONS | MIN | TYP | MAX | UNIT |
|------------------------|---|--------|-----|-------|---------|
| Pass-band ripple | Frequency range is 0 to $0.466 \times f_s$ | -0.04 | | 0.04 | dB |
| Stop-band attenuation | Frequency range is $0.6 \times f_s$ onwards | 86.3 | | | dB |
| Group delay or latency | Frequency range is 0 to $0.365 \times f_s$ | | 7.7 | | $1/f_s$ |
| Group delay deviation | Frequency range is 0 to $0.365 \times f_s$ | -0.027 | | 0.027 | $1/f_s$ |
| Phase deviation | Frequency range is 0 to $0.365 \times f_s$ | -0.26 | | 0.30 | Degrees |

8.3.8.7.2.6 Sampling Rate: 192 kHz or 176.4 kHz

Figure 8-53 shows the magnitude response and Figure 8-54 shows the pass-band ripple and phase deviation for a decimation filter with a sampling rate of 192 kHz or 176.4 kHz. Table 8-34 lists the specifications for a decimation filter with a 192-kHz or 176.4-kHz sampling rate.

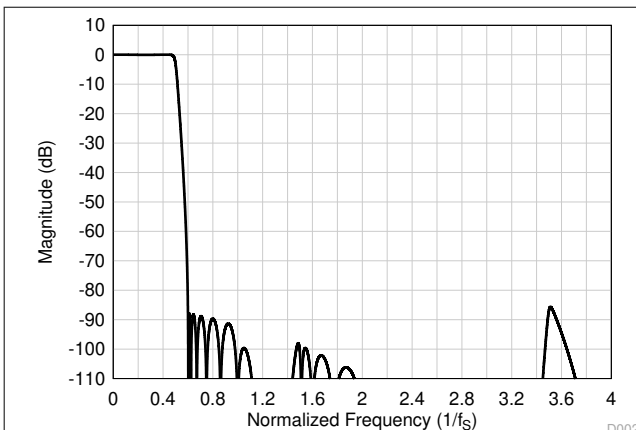

Figure 8-53. Low-Latency Decimation Filter Magnitude Response

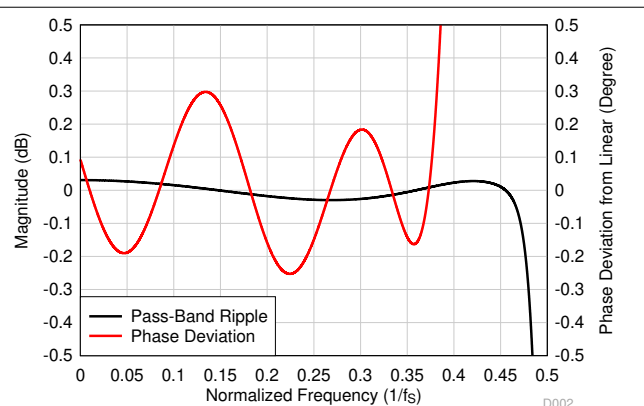

Figure 8-54. Low-Latency Decimation Filter Pass-Band Ripple and Phase Deviation

Table 8-34. Low-Latency Decimation Filter Specifications

| PARAMETER | TEST CONDITIONS | MIN | TYP | MAX | UNIT |
|------------------------|---|--------|-----|-------|---------|
| Pass-band ripple | Frequency range is 0 to $463 \times f_S$ | -0.03 | | 0.03 | dB |
| Stop-band attenuation | Frequency range is $0.6 \times f_S$ onwards | 85.6 | | | dB |
| Group delay or latency | Frequency range is 0 to $0.365 \times f_S$ | | 7.7 | | $1/f_S$ |
| Group delay deviation | Frequency range is 0 to $0.365 \times f_S$ | -0.027 | | 0.027 | $1/f_S$ |
| Phase deviation | Frequency range is 0 to $0.365 \times f_S$ | -0.26 | | 0.30 | Degrees |

8.3.8.7.3 Ultra-Low-Latency Filters

For applications where ultra-low latency (within the audio band) is critical, the ultra-low-latency decimation filters on the PCM6480-Q1 can be used. The device supports these filters with a group delay of approximately four samples with an almost linear phase response within the $0.325 \times f_S$ frequency band. This section provides the filter performance specifications and various plots for all supported output sampling rates for the ultra-low-latency filters.

8.3.8.7.3.1 Sampling Rate: 16 kHz or 14.7 kHz

Figure 8-55 shows the magnitude response and Figure 8-56 shows the pass-band ripple and phase deviation for a decimation filter with a sampling rate of 16 kHz or 14.7 kHz. Table 8-35 lists the specifications for a decimation filter with a 16-kHz or 14.7-kHz sampling rate.

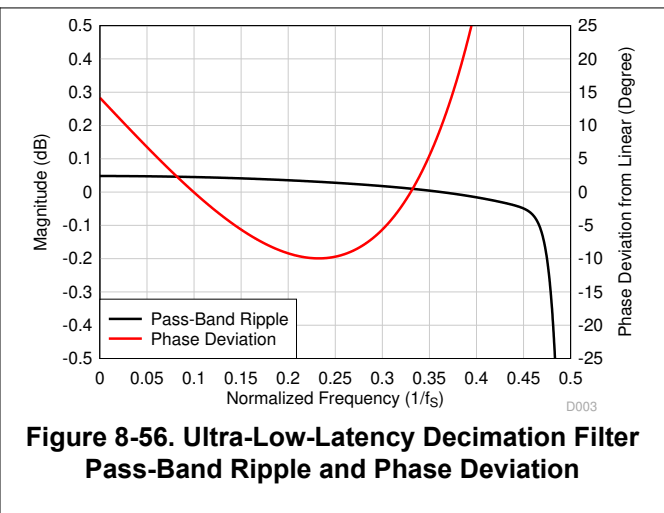
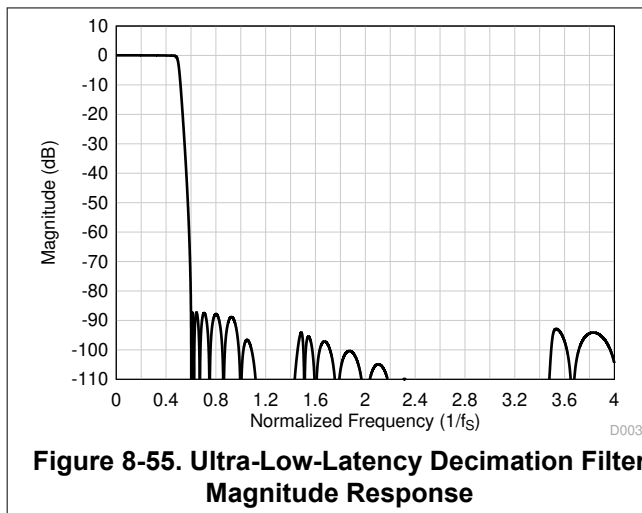

Table 8-35. Ultra-Low-Latency Decimation Filter Specifications

| PARAMETER | TEST CONDITIONS | MIN | TYP | MAX | UNIT |
|------------------------|---|--------|-----|-------|---------|
| Pass-band ripple | Frequency range is 0 to $0.45 \times f_S$ | -0.05 | | 0.05 | dB |
| Stop-band attenuation | Frequency range is $0.6 \times f_S$ onwards | 87.2 | | | dB |
| Group delay or latency | Frequency range is 0 to $0.325 \times f_S$ | | 4.3 | | $1/f_S$ |
| Group delay deviation | Frequency range is 0 to $0.325 \times f_S$ | -0.512 | | 0.512 | $1/f_S$ |
| Phase deviation | Frequency range is 0 to $0.325 \times f_S$ | -10.0 | | 14.2 | Degrees |

8.3.8.7.3.2 Sampling Rate: 24 kHz or 22.05 kHz

Figure 8-57 shows the magnitude response and Figure 8-58 shows the pass-band ripple and phase deviation for a decimation filter with a sampling rate of 24 kHz or 22.05 kHz. Table 8-36 lists the specifications for a decimation filter with a 24-kHz or 22.05-kHz sampling rate.

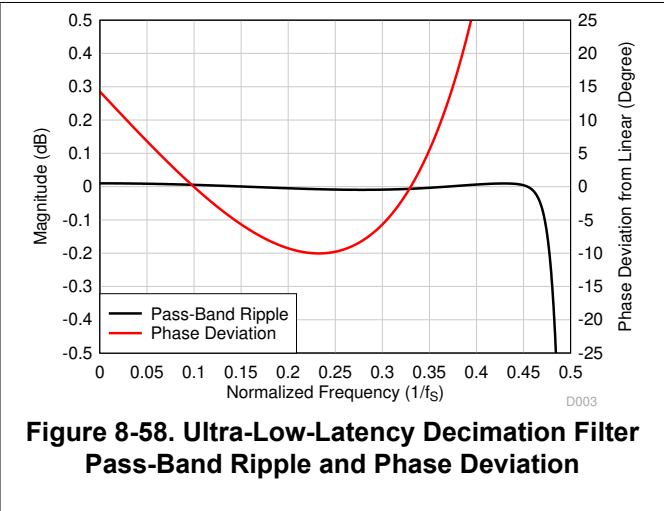
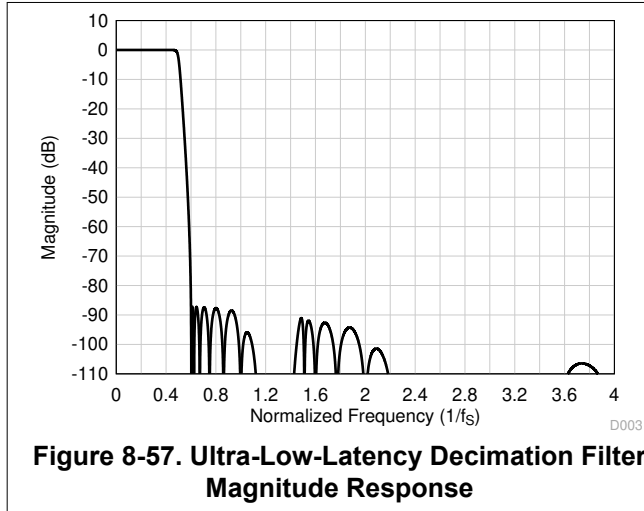

Table 8-36. Ultra-Low-Latency Decimation Filter Specifications

| PARAMETER | TEST CONDITIONS | MIN | TYP | MAX | UNIT |
|------------------------|---|--------|-----|-------|---------|
| Pass-band ripple | Frequency range is 0 to $0.46 \times f_s$ | -0.01 | | 0.01 | dB |
| Stop-band attenuation | Frequency range is $0.6 \times f_s$ onwards | 87.1 | | | dB |
| Group delay or latency | Frequency range is 0 to $0.325 \times f_s$ | | 4.1 | | $1/f_s$ |
| Group delay deviation | Frequency range is 0 to $0.325 \times f_s$ | -0.514 | | 0.514 | $1/f_s$ |
| Phase deviation | Frequency range is 0 to $0.325 \times f_s$ | -10.0 | | 14.3 | Degrees |

8.3.8.7.3.3 Sampling Rate: 32 kHz or 29.4 kHz

Figure 8-59 shows the magnitude response and Figure 8-60 shows the pass-band ripple and phase deviation for a decimation filter with a sampling rate of 32 kHz or 29.4 kHz. Table 8-37 lists the specifications for a decimation filter with an 32-kHz or 29.4-kHz sampling rate.

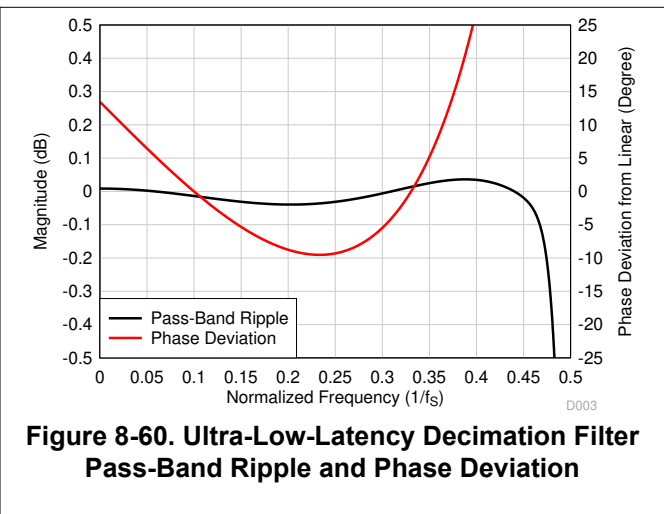
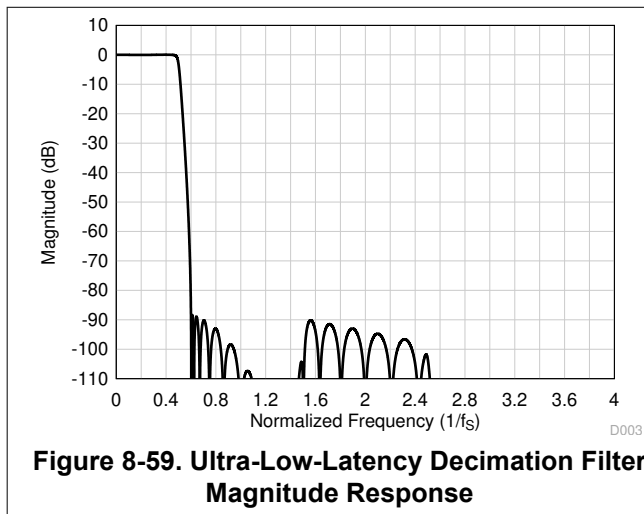

Table 8-37. Ultra-Low-Latency Decimation Filter Specifications

| PARAMETER | TEST CONDITIONS | MIN | TYP | MAX | UNIT |
|------------------------|---|--------|-----|-------|---------|
| Pass-band ripple | Frequency range is 0 to $0.457 \times f_S$ | -0.04 | | 0.04 | dB |
| Stop-band attenuation | Frequency range is $0.6 \times f_S$ onwards | 88.3 | | | dB |
| Group delay or latency | Frequency range is 0 to $0.325 \times f_S$ | | 5.2 | | $1/f_S$ |
| Group delay deviation | Frequency range is 0 to $0.325 \times f_S$ | -0.492 | | 0.492 | $1/f_S$ |
| Phase deviation | Frequency range is 0 to $0.325 \times f_S$ | -9.5 | | 13.5 | Degrees |

8.3.8.7.3.4 Sampling Rate: 48 kHz or 44.1 kHz

Figure 8-61 shows the magnitude response and Figure 8-62 shows the pass-band ripple and phase deviation for a decimation filter with a sampling rate of 48 kHz or 44.1 kHz. Table 8-38 lists the specifications for a decimation filter with a 48-kHz or 44.1-kHz sampling rate.

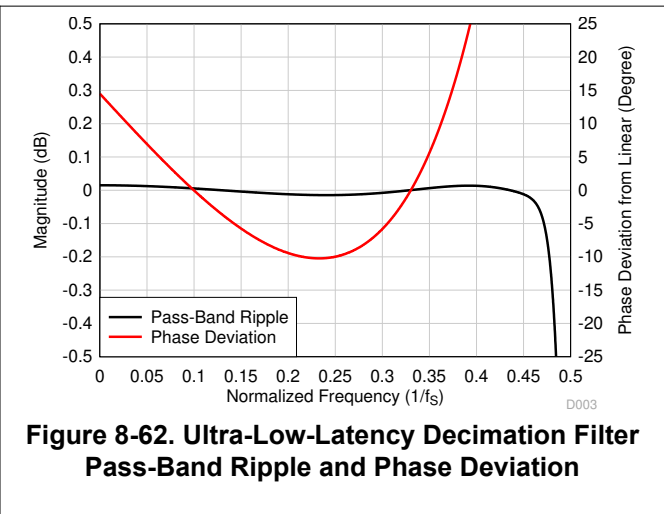
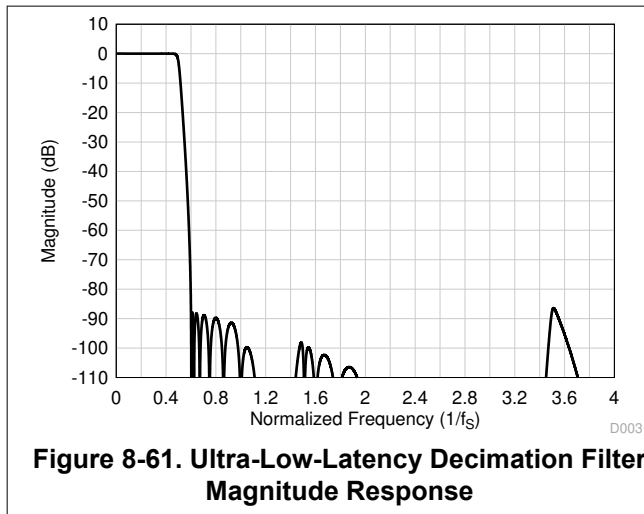

Table 8-38. Ultra-Low-Latency Decimation Filter Specifications

| PARAMETER | TEST CONDITIONS | MIN | TYP | MAX | UNIT |
|------------------------|---|--------|-----|-------|---------|
| Pass-band ripple | Frequency range is 0 to $0.452 \times f_S$ | -0.015 | | 0.015 | dB |
| Stop-band attenuation | Frequency range is $0.6 \times f_S$ onwards | 86.4 | | | dB |
| Group delay or latency | Frequency range is 0 to $0.325 \times f_S$ | | 4.1 | | $1/f_S$ |
| Group delay deviation | Frequency range is 0 to $0.325 \times f_S$ | -0.525 | | 0.525 | $1/f_S$ |
| Phase deviation | Frequency range is 0 to $0.325 \times f_S$ | -10.3 | | 14.5 | Degrees |

8.3.8.7.3.5 Sampling Rate: 96 kHz or 88.2 kHz

Figure 8-63 shows the magnitude response and Figure 8-64 shows the pass-band ripple and phase deviation for a decimation filter with a sampling rate of 96 kHz or 88.2 kHz. Table 8-39 lists the specifications for a decimation filter with a 96-kHz or 88.2-kHz sampling rate.

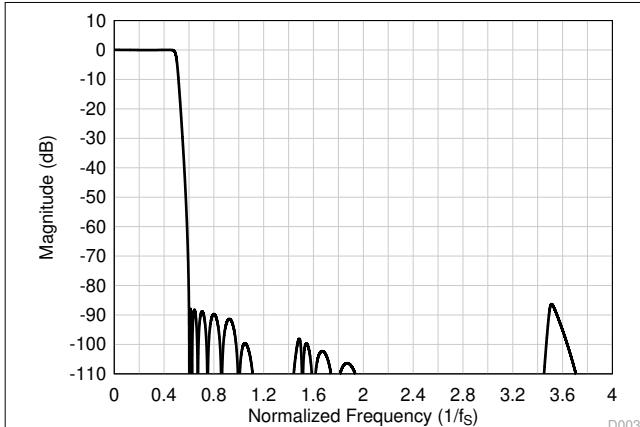

Figure 8-63. Ultra-Low-Latency Decimation Filter Magnitude Response

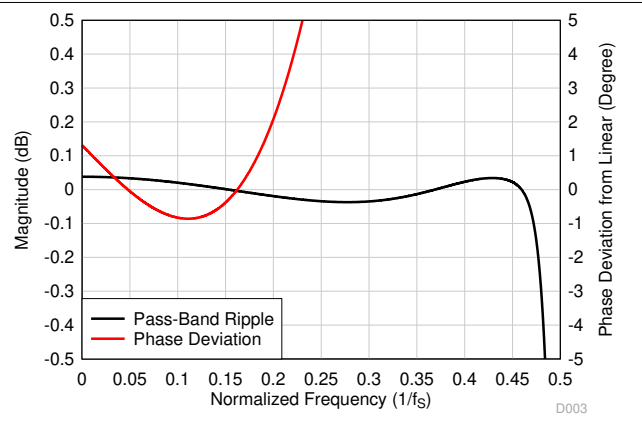

Figure 8-64. Ultra-Low-Latency Decimation Filter Pass-Band Ripple and Phase Deviation

Table 8-39. Ultra-Low-Latency Decimation Filter Specifications

| PARAMETER | TEST CONDITIONS | MIN | TYP | MAX | UNIT |
|------------------------|---|--------|-----|-------|---------|
| Pass-band ripple | Frequency range is 0 to $0.466 \times f_s$ | -0.04 | | 0.04 | dB |
| Stop-band attenuation | Frequency range is $0.6 \times f_s$ onwards | 86.3 | | | dB |
| Group delay or latency | Frequency range is 0 to $0.1625 \times f_s$ | | 3.7 | | $1/f_s$ |
| Group delay deviation | Frequency range is 0 to $0.1625 \times f_s$ | -0.091 | | 0.091 | $1/f_s$ |
| Phase deviation | Frequency range is 0 to $0.1625 \times f_s$ | -0.86 | | 1.30 | Degrees |

8.3.8.7.3.6 Sampling Rate: 192 kHz or 176.4 kHz

Figure 8-65 shows the magnitude response and Figure 8-66 shows the pass-band ripple and phase deviation for a decimation filter with a sampling rate of 192 kHz or 176.4 kHz. Table 8-40 lists the specifications for a decimation filter with a 192-kHz or 176.4-kHz sampling rate.

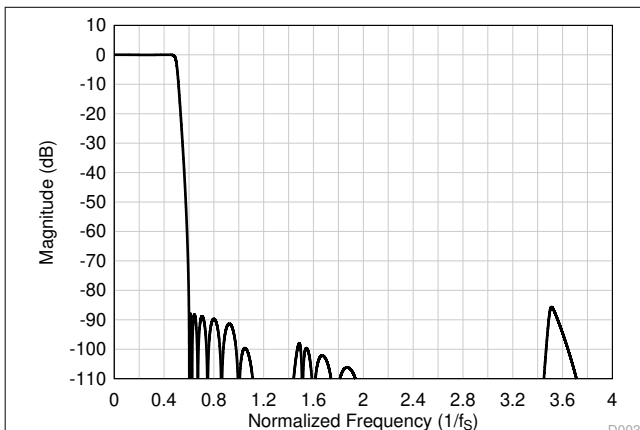

Figure 8-65. Ultra-Low-Latency Decimation Filter Magnitude Response

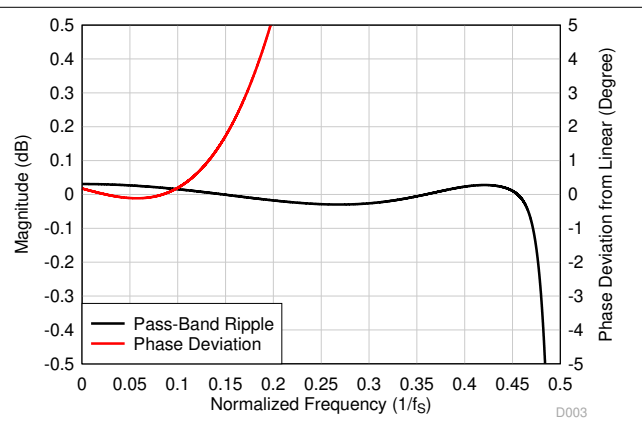

Figure 8-66. Ultra-Low-Latency Decimation Filter Pass-Band Ripple and Phase Deviation

Table 8-40. Ultra-Low-Latency Decimation Filter Specifications

| PARAMETER | TEST CONDITIONS | MIN | TYP | MAX | UNIT |
|------------------------|---|--------|-----|-------|---------|
| Pass-band ripple | Frequency range is 0 to $0.463 \times f_S$ | -0.03 | | 0.03 | dB |
| Stop-band attenuation | Frequency range is $0.6 \times f_S$ onwards | 85.6 | | | dB |
| Group delay or latency | Frequency range is 0 to $0.085 \times f_S$ | | 3.7 | | $1/f_S$ |
| Group delay deviation | Frequency range is 0 to $0.085 \times f_S$ | -0.024 | | 0.024 | $1/f_S$ |
| Phase deviation | Frequency range is 0 to $0.085 \times f_S$ | -0.12 | | 0.18 | Degrees |

8.3.8.7.3.7 Sampling Rate: 384 kHz or 352.8 kHz

Figure 8-67 shows the magnitude response and Figure 8-68 shows the pass-band ripple and phase deviation for a decimation filter with a sampling rate of 384 kHz or 352.8 kHz. Table 8-41 lists the specifications for a decimation filter with a 384-kHz or 352.8-kHz sampling rate.

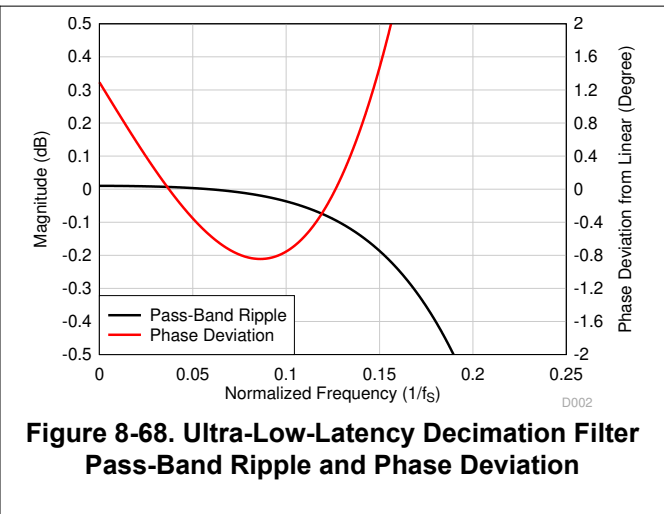
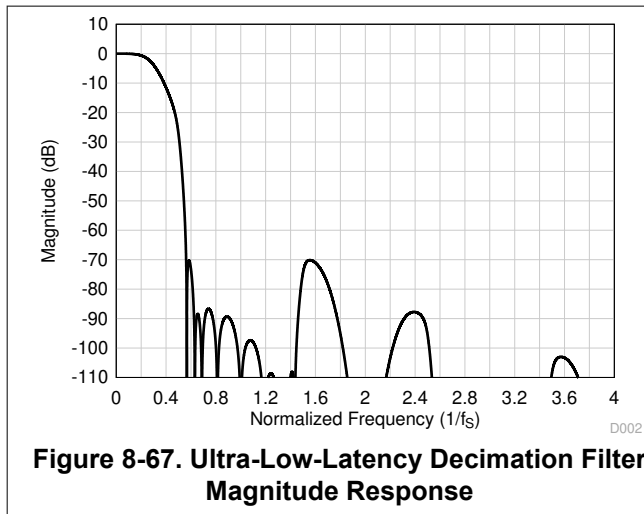

Table 8-41. Ultra-Low-Latency Decimation Filter Specifications

| PARAMETER | TEST CONDITIONS | MIN | TYP | MAX | UNIT |
|------------------------|--|-------|-----|------|---------|
| Pass-band ripple | Frequency range is 0 to $0.1 \times f_S$ | -0.04 | | 0.01 | dB |
| Stop-band attenuation | Frequency range is $0.56 \times f_S$ onwards | 70.1 | | | dB |
| Group delay or latency | Frequency range is 0 to $0.157 \times f_S$ | | 4.1 | | $1/f_S$ |
| Group delay deviation | Frequency range is 0 to $0.157 \times f_S$ | -0.18 | | 0.18 | $1/f_S$ |
| Phase deviation | Frequency range is 0 to $0.157 \times f_S$ | -0.85 | | 2.07 | Degrees |

8.3.9 Automatic Gain Controller (AGC)

The device includes an automatic gain controller (AGC) for ADC recording that must be used only for the AC-coupled input configuration. As shown in Figure 8-69, the AGC can be used to maintain a nominally constant output level when recording speech. Instead of manually setting the channel gain in AGC mode, the circuitry automatically adjusts the channel gain when the input signal becomes overly loud or very weak, such as when a person speaking into a microphone moves closer to or farther from the microphone. The AGC algorithm has several programmable parameters, including target level, maximum gain allowed, attack and release (or decay) time constants, and noise thresholds that allow the algorithm to be fine-tuned for any particular application.

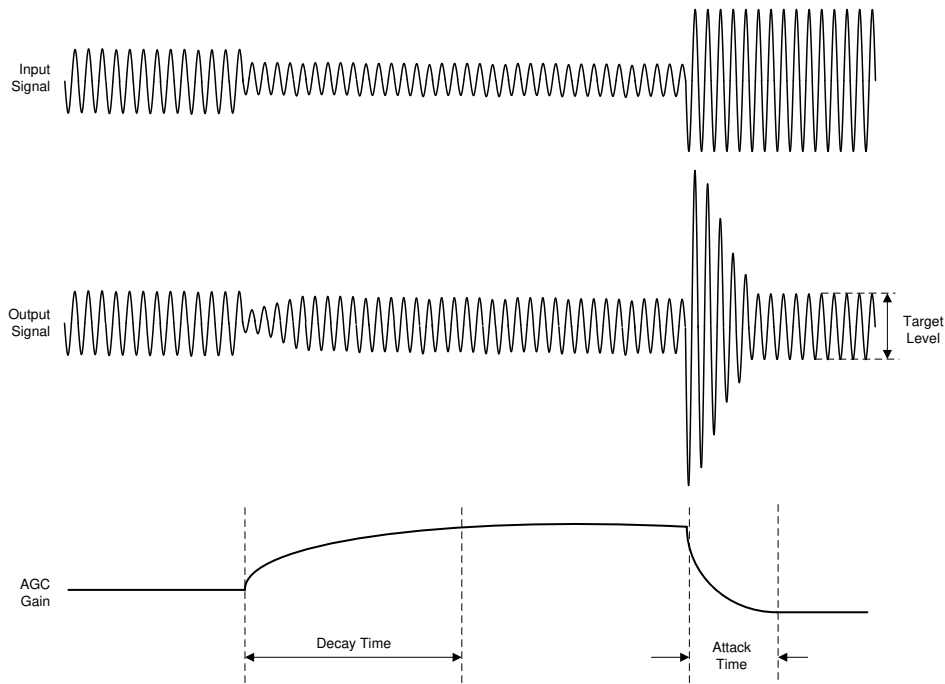

Figure 8-69. AGC Characteristics

The target level (AGC_LVL) represents the nominal output level at which the AGC attempts to hold the ADC output signal level. The PCM6480-Q1 allows programming of different target levels, which can be programmed from -6 dB to -36 dB relative to a full-scale signal, and the AGC_LVL default value is set to -34 dB. The target level is recommended to be set with enough margin to prevent clipping when loud sounds occur. Table 8-42 lists the AGC target level configuration settings.

Table 8-42. AGC Target Level Programmable Settings

| P0_R112_D[7:4] : AGC_LVL[3:0] | AGC TARGET LEVEL FOR OUTPUT |
|-------------------------------|---|
| 0000 | The AGC target level is the -6 -dB output signal level |
| 0001 | The AGC target level is the -8 -dB output signal level |
| 0010 | The AGC target level is the -10 -dB output signal level |
| ... | ... |
| 1110 (default) | The AGC target level is the -34 -dB output signal level |
| 1111 | The AGC target level is the -36 -dB output signal level |

The maximum gain allowed (AGC_MAXGAIN) gives flexibility to the designer to restrict the maximum gain applied by the AGC. This feature limits the channel gain in situations where environmental noise is greater than the programmed noise threshold. The AGC_MAXGAIN can be programmed from 3 dB to 42 dB with steps of 3 dB and the default value is set to 24 dB. [Table 8-43](#) lists the AGC_MAXGAIN configuration settings.

Table 8-43. AGC Maximum Gain Programmable Settings

| P0_R112_D[3:0] : AGC_MAXGAIN[3:0] | AGC MAXIMUM GAIN ALLOWED |
|--------------------------------------|---------------------------------------|
| 0000 | The AGC maximum gain allowed is 3 dB |
| 0001 | The AGC maximum gain allowed is 6 dB |
| 0010 | The AGC maximum gain allowed is 9 dB |
| ... | ... |
| 0111 (default) | The AGC maximum gain allowed is 24 dB |
| ... | ... |
| 1110 | The AGC maximum gain allowed is 39 dB |
| 1111 | The AGC maximum gain allowed is 42 dB |

For further details on the AGC various configurable parameter and application use, see the [Using the Automatic Gain Controller in PCM6xx0-Q1 application report](#).

8.3.10 Interrupts, Status, and Digital I/O Pin Multiplexing

Certain events in the device may require host processor intervention and can be used to trigger interrupts to the host processor. Such event are an audio serial interface (ASI) bus error and input DC fault diagnostic faults. The device powers down the record channels if any faults are detected with the ASI bus error clocks, such as:

- Invalid FSYNC frequency
- Invalid SBCLK to FSYNC ratio
- Long pauses of the SBCLK or FSYNC clocks

When an ASI bus clock error is detected, the device shuts down the record channel as quickly as possible. After all ASI bus clock errors are resolved, the device volume ramps back to its previous state to recover the record channel. During an ASI bus clock error, the internal interrupt request (IRQ) interrupt signal asserts low if the clock error interrupt mask register bit INT_MASK0[7], P0_R51_D7 is set low. The clock fault is also available for readback in the live fault status register bit INT_LIVE0, P1_R44 and is also latched to the fault status register bit INT_LTCH0, P0_R44, which is a read-only register. Reading the latched fault status register, INT_LTCH0, clears all latched fault statuses. The device can be additionally configured to route the internal IRQ interrupt signal on the GPIOx pins and also can be configured as an open-drain output so that these pins can be wire-ANDed to the open-drain interrupt outputs of other devices.

When an input DC fault event is detected, the internal IRQ signal is asserted if the interrupt mask registers INT_MASK1, P0_R42 and INT_MASK2, P0_R43 are configured appropriately to unmask all desired fault diagnostics interrupts. Each input channel can be independently set for an interrupt mask. [Table 8-44](#) and [Table 8-45](#) list the mask settings available for the input DC diagnostics fault interrupts.

Table 8-44. Interrupt Mask Register 1 for DC Faults Diagnostic

| P0_R42 : INT_MASK1 | INTERRUPT MASK REGISTER 1 FOR DC FAULTS DIAGNOSTIC INTERRUPTS |
|--------------------|--|
| INT_MASK1[7] | Channel 1 input DC faults diagnostic interrupt mask and unmask register bit |
| INT_MASK1[6] | Channel 2 input DC faults diagnostic interrupt mask and unmask register bit |
| INT_MASK1[5] | Channel 3 input DC faults diagnostic interrupt mask and unmask register bit |
| INT_MASK1[4] | Channel 4 input DC faults diagnostic interrupt mask and unmask register bit |
| INT_MASK1[3] | Channel 5 input DC faults diagnostic interrupt mask and unmask register bit |
| INT_MASK1[2] | Channel 6 input DC faults diagnostic interrupt mask and unmask register bit |
| INT_MASK1[1] | Short to VBAT_IN (when VBAT_IN is lower than MICBIAS) fault interrupt mask and unmask register bit |
| INT_MASK1[0] | Reserved |

Table 8-45. Interrupt Mask Register 2 for DC Faults Diagnostic

| P0_R43 : INT_MASK2 | INTERRUPT MASK REGISTER 2 FOR DC FAULTS DIAGNOSTIC INTERRUPTS |
|--------------------|---|
| INT_MASK2[7] | Open input fault interrupt mask and unmask register bit for all channels |
| INT_MASK2[6] | Inputs shorted together fault interrupt mask and unmask register bit for all channels |
| INT_MASK2[5] | INxP input shorted to ground fault interrupt mask and unmask register bit for all channels |
| INT_MASK2[4] | INxM input shorted to ground fault interrupt mask and unmask register bit for all channels |
| INT_MASK2[3] | INxP input shorted to MICBIAS fault interrupt mask and unmask register bit for all channels |
| INT_MASK2[2] | INxM input shorted to MICBIAS fault interrupt mask and unmask register bit for all channels |
| INT_MASK2[1] | INxP input shorted to VBAT_IN fault interrupt mask and unmask register bit for all channels |
| INT_MASK2[0] | INxM input shorted to VBAT_IN fault interrupt mask and unmask register bit for all channels |

The device supports the channel-specific input DC fault latched status registers for all channels from CH1_LTCH, P0_R46 to CH6_LTCH, P0_R51, which are read-only registers. The device also has a consolidated summary status register across channels for the input DC latched fault status register, CHx_LTCH, P0_R45 that the host can read to quickly know which channel fault has occurred. Reading the latched fault status registers, CH1_LTCH to CH6_LTCH, clears all the latched fault status including the summary status register, CHx_LTCH. [Table 8-46](#) shows various input DC fault diagnostics status bits that are supported by the device.

Table 8-46. Input DC Faults Diagnostic Latched Status

| P0_R46 : CH1_LTCH | CHANNEL 1 INPUT FAULTS DIAGNOSTIC LATCHED STATUS |
|-------------------|--|
| CH1_LTCH[7] | Channel 1 open input fault detection status bit (self-clearing bit) |
| CH1_LTCH[6] | Channel 1 inputs shorted together fault detection status bit (self-clearing bit) |
| CH1_LTCH[5] | Channel 1 IN1P input shorted to ground fault detection status bit (self-clearing bit) |
| CH1_LTCH[4] | Channel 1 IN1M input shorted to ground fault detection status bit (self-clearing bit) |
| CH1_LTCH[3] | Channel 1 IN1P input shorted to MICBIAS fault detection status bit (self-clearing bit) |
| CH1_LTCH[2] | Channel 1 IN1M input shorted to MICBIAS fault detection status bit (self-clearing bit) |
| CH1_LTCH[1] | Channel 1 IN1P input shorted to VBAT_IN fault detection status bit (self-clearing bit) |
| CH1_LTCH[0] | Channel 1 IN1M input shorted to VBAT_IN fault detection status bit (self-clearing bit) |

Similarly, the DC faults diagnostic latched status for input channel 2 to channel 6 can be monitored using the CH2_LTCH (P0_R47) to CH6_LTCH (P0_R51) registers, respectively.

The device GPIOx pins can be additionally configured to route the internal IRQ interrupt signal on the GPIOx pins and also can be configured as an open-drain output so that this pin can be wire-ANDed to the open-drain interrupt outputs of other devices.

The IRQ interrupt signal can either be configured as an active low or active high polarity by setting the INT_POL, P0_R40_D7 register bit. This signal can also be configured as a single pulse or a series of pulses by programming the INT_EVENT[1:0], P0_R40_D[6:5] register bits. If the interrupts are configured as a series of pulses, the events trigger the start of pulses that stop when the latched fault status register is read to determine the cause of the interrupt.

The device also supports read-only live status registers that determine if all the channels are powered up or down and if the device is in sleep mode or not. These status registers are located in P0_R118, DEV_STS0 and P0_R119, DEV_STS1.

The device has a GPIO1 multifunction pin that can be configured for a desired specific function. Additionally, the PCM6480-Q1 has two more GPIO pins and two GPI pins supported that can be used in the system for the PDM microphone interface or for various other features. [Table 8-47](#) shows all possible allocation of these multifunction pins for all the various features.

Table 8-47. Multifunction Pin Assignments

| ROW | PIN FUNCTION | GPIO1 | GPIO2 | GPIO3 | GPI1 | GPI2 |
|-----|-------------------------------|------------------|-----------------|-----------------|-------------------|---------------|
| — | — | GPIO1_CFG [4:0] | GPIO2_CFG [4:0] | GPIO3_CFG [4:0] | GPI1_CFG[4:0] | GPI2_CFG[4:0] |
| — | — | P0_R33[7:4] | P0_R34[7:4] | P0_R35[7:4] | P0_R36[7:4] | P0_R37[7:4] |
| A | Pin disabled | S ⁽¹⁾ | S (default) | S (default) | S (default) | S (default) |
| B | General-purpose output (GPO) | S | S | S | NS ⁽²⁾ | NS |
| C | Interrupt output (IRQ) | S (default) | S | S | NS | NS |
| D | Secondary ASI output (SDOUT2) | S | S | S | NS | NS |
| F | MicBIAS on/off input (BIASEN) | S | S | S | S | S |
| G | General-purpose input (GPI) | S | S | S | S | S |
| H | Master clock input (MCLK) | S | S | S | S | S |
| I | ASI daisy-chain input (SDIN) | S | S | S | S | S |

(1) S means the feature mentioned in this row is *supported* for the respective GPIO1, GPOx, or GPIx pin mentioned in this column.

(2) NS means the feature mentioned in this row is *not supported* for the respective GPIO1, GPOx, or GPIx pin mentioned in this column.

Each GPIOx pin can be independently set for the desired drive configurations setting using the GPIOx_DRV[3:0] register bits. [Table 8-48](#) lists the drive configuration settings.

Table 8-48. GPIOx Pins Drive Configuration Settings

| P0_R33_D[3:0] : GPIO1_DRV[3:0] | GPIO OUTPUT DRIVE CONFIGURATION SETTINGS FOR GPIO1 |
|--------------------------------|--|
| 000 | The GPIO1 pin is set to high impedance (floated) |
| 001 | The GPIO1 pin is set to be driven active low or active high |
| 010 (default) | The GPIO1 pin is set to be driven active low or weak high (on-chip pullup) |
| 011 | The GPIO1 pin is set to be driven active low or Hi-Z (floated) |
| 100 | The GPIO1 pin is set to be driven weak low (on-chip pulldown) or active high |
| 101 | The GPIO1 pin is set to be driven Hi-Z (floated) or active high |
| 110 and 111 | Reserved (do not use these settings) |

Similarly, the GPIO2 and GPIO3 pins can be configured using the GPIO2_DRV(P0_R34) and GPIO3_DRV(P0_R35) register bits, respectively.

When configured as a general-purpose output (GPO), the GPIOx pin values can be driven by writing the GPIO_VAL_P0_R38 registers. The GPIO_MON, P0_R39 register can be used to readback the status of the GPIOx and GPIx pins when configured as a general-purpose input (GPI).

8.4 Device Functional Modes

8.4.1 Hardware Shutdown

The device enters hardware shutdown mode when the SHDNZ pin is asserted low or the AVDD supply voltage is not applied to the device. In hardware shutdown mode, the device consumes the minimum quiescent current from the AVDD supply. All configuration registers and programmable coefficients lose their value in this mode, and I²C or SPI communication to the device is not supported.

If the SHDNZ pin is asserted low when the device is in active mode, the device ramps down volume on the record data, powers down the analog and digital blocks, and puts the device into hardware shutdown mode in 25 ms (typical). The device can also be immediately put into hardware shutdown mode from active mode if the SHDNZ_CFG[1:0], P0_R5_D[3:2], register bits are set to 2'b00. After the SHDNZ pin is asserted low, and after the device enters hardware shutdown mode, keep the SHDNZ pin low for at least 1 ms before releasing SHDNZ for further device operation.

Assert the SHDNZ pin high only when the IOVDD supply settles to a steady voltage level. When the SHDNZ pin goes high, the device sets all configuration registers and programmable coefficients to their default values, and then enters sleep mode.

8.4.2 Sleep Mode or Software Shutdown

In sleep mode or software shutdown mode, the device consumes very low quiescent current from the AVDD supply and, at the same time, allows the I²C or SPI communication to wake the device for active operation.

The device can also enter sleep mode when the host device sets the SLEEP_ENZ, P0_R2_D0 bit to 1'b0. If the SLEEP_ENZ bit is asserted low when the device is in active mode, the device ramps down the volume on the record data, powers down the analog and digital blocks, and enters sleep mode. However, the device still continues to retain the last programmed value of the device configuration registers and programmable coefficients.

In sleep mode, do not perform any I²C or SPI transactions, except for exiting sleep mode in order to enter active mode. After entering sleep mode, wait at least 10 ms before starting I²C or SPI transactions to exit sleep mode.

8.4.3 Active Mode

If the host device exits sleep mode by setting the SLEEP_ENZ bit to 1'b1, the device enters active mode. In active mode, I²C or SPI transactions can be done to configure and power-up the device for active operation. After entering active mode, wait at least 1 ms before starting any I²C or SPI transactions in order to allow the device to complete the internal wake-up sequence.

After configuring all other registers for the target application and system settings, configure the input and output channel enable registers, P0_R115 (IN_CH_EN) and P0_R116 (ASI_OUT_CH_EN), respectively. Lastly, configure the device power-up register, P0_R117 (PWR_CFG). All programmable coefficient values must be written before powering up the respective channel.

In active mode, the power-up and power-down status of various blocks is monitored by reading the read-only device status bits located in the P0_R117 (DEV_STS0) and P0_R118 (DEV_STS1) registers.

8.4.4 Software Reset

A software reset can be done any time by asserting the SW_RESET bit, P0_R1_D0, which is a self-clearing bit. This software reset immediately shuts down the device, and restores all device configuration registers and programmable coefficients to their default values.

8.5 Programming

The device contains configuration registers and programmable coefficients that can be set to the desired values for a specific system and application use. These registers are called *device control registers* and are each eight bits in width, mapped using a page scheme.

Each page contains 128 configuration registers. All device configuration registers are stored in page 0, which is the default page setting at power up (and after a software reset). Page 1 consists of the live status registers and input diagnostic successive-approximation register (SAR) data for advanced diagnostic purposes. All programmable coefficient registers are located in page 2, page 3, and page 4. The current page of the device can be switched to a new desired page by using the PAGE[7:0] bits located in register 0 of every page.

8.5.1 Control Serial Interfaces

The device control registers can be accessed using either I²C or SPI communication to the device.

By monitoring the SDA_SSZ, SCL_MOSI, ADDR0_SCLK, and ADDR1_MISO device pins, which are the multiplexed pins for the I²C or SPI Interface, the device automatically detects whether the host device is using I²C or SPI communication to configure the device. For a given end application, the host device must always use either the I²C or SPI interface, but not both, to configure the device.

8.5.1.1 I²C Control Interface

The device supports the I²C control protocol as a slave device and is capable of operating in standard mode, fast mode, and fast mode plus. The I²C control protocol requires a 7-bit slave address. The five most significant bits (MSBs) of the slave address are fixed at 10010 and cannot be changed. The two least significant bits (LSBs) are programmable and are controlled by the ADDR0_SCLK and ADDR1_MISO pins. These two pins must always be either pulled to VSS or IOVDD. If the I2C_BRDCAST_EN (P0_R2_D2) bit is set to 1'b1, then the I²C slave address is fixed to 1001000 in order to allow simultaneous I²C broadcast communication to all PCM6480-Q1 devices in the system. [Table 8-49](#) lists the four possible device addresses resulting from this configuration.

Table 8-49. I²C Slave Address Settings

| ADDR1_MISO | ADDR0_SCLK | I2C_BRDCAST_EN (P0_R2_D2) | I ² C SLAVE ADDRESS |
|------------|------------|---------------------------|--------------------------------|
| 0 | 0 | 0 (default) | 1001 000 |
| 0 | 1 | 0 (default) | 1001 001 |
| 1 | 0 | 0 (default) | 1001 010 |
| 1 | 1 | 0 (default) | 1001 011 |
| X | X | 1 | 1001 000 |

8.5.1.1.1 General I²C Operation

The I²C bus employs two signals, SDA (data) and SCL (clock), to communicate between the integrated circuits in a system using serial data transmission. The address and data 8-bit bytes are transferred MSB first. In addition, each byte transferred on the bus is acknowledged by the receiving device with an acknowledge bit. Each transfer operation begins with the master device driving a START condition on the bus and ends with the master device driving a STOP condition on the bus. The bus uses transitions on the data pin (SDA) when the clock is at logic high to indicate START and STOP conditions. A high-to-low transition on SDA indicates a START, and a low-to-high transition indicates a STOP condition. Normal data-bit transitions must occur within the low time of the clock period.

The master device drives a START condition followed by the 7-bit slave address and the read/write (R/W) bit to open communication with another device and then waits for an acknowledgment condition. The slave device holds SDA low during the acknowledge clock period to indicate acknowledgment. When this step occurs, the master device transmits the next byte of the sequence. Each slave device is addressed by a unique 7-bit slave address plus the R/W bit (1 byte). All compatible devices share the same signals via a bidirectional bus using a wired-AND connection.

There is no limit on the number of bytes that can be transmitted between START and STOP conditions. When the last word transfers, the master device generates a STOP condition to release the bus. Figure 8-70 shows a generic data transfer sequence.

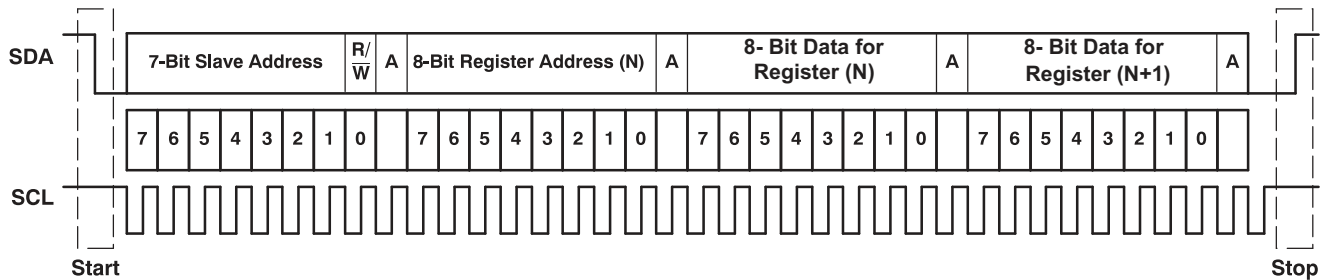

Figure 8-70. Typical I²C Sequence

In the system, use external pullup resistors for the SDA and SCL signals to set the logic high level for the bus. The SDA and SCL voltages must not exceed the device supply voltage, IOVDD.

8.5.1.1.2 I²C Single-Byte and Multiple-Byte Transfers

The device I²C interface supports both single-byte and multiple-byte read/write operations for all registers. During multiple-byte read operations, the device responds with data, a byte at a time, starting at the register assigned, as long as the master device continues to respond with acknowledges.

The device supports sequential I²C addressing. For write transactions, if a register is issued followed by data for that register and all the remaining registers that follow, a sequential I²C write transaction takes place. For I²C sequential write transactions, the register issued then serves as the starting point, and the amount of data subsequently transmitted, before a STOP or START condition is transmitted, determines how many registers are written.

8.5.1.1.2.1 I²C Single-Byte Write

As shown in Figure 8-71, a single-byte data write transfer begins with the master device transmitting a START condition followed by the I²C device address and the read/write bit. The read/write bit determines the direction of the data transfer. For a write-data transfer, the read/write bit must be set to 0. After receiving the correct I²C slave address and the read/write bit, the device responds with an acknowledge bit (ACK). Next, the master device transmits the register byte corresponding to the device internal register address being accessed. After receiving the register byte, the device again responds with an acknowledge bit (ACK). Then, the master transmits the byte of data to be written to the specified register. When finished, the slave device responds with an acknowledge bit (ACK). Finally, the master device transmits a STOP condition to complete the single-byte data write transfer.

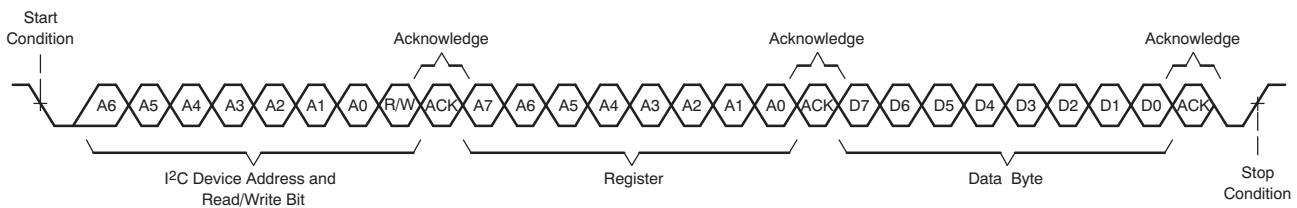

Figure 8-71. I²C Single-Byte Write Transfer

8.5.1.1.2.2 I²C Multiple-Byte Write

As shown in Figure 8-72, a multiple-byte data write transfer is identical to a single-byte data write transfer except that multiple data bytes are transmitted by the master device to the slave device. After receiving each data byte, the device responds with an acknowledge bit (ACK). Finally, the master device transmits a STOP condition after the last data-byte write transfer.

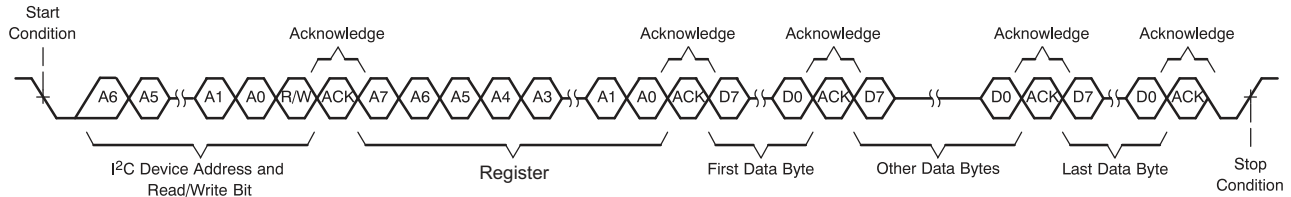

Figure 8-72. I²C Multiple-Byte Write Transfer

8.5.1.1.2.3 I²C Single-Byte Read

As shown in Figure 8-73, a single-byte data read transfer begins with the master device transmitting a START condition followed by the I²C slave address and the read/write bit. For the data read transfer, both a write followed by a read are done. Initially, a write is done to transfer the address byte of the internal register address to be read. As a result, the read/write bit is set to 0.

After receiving the slave address and the read/write bit, the device responds with an acknowledge bit (ACK). The master device then sends the internal register address byte, after which the device issues an acknowledge bit (ACK). The master device transmits another START condition followed by the slave address and the read/write bit again. This time, the read/write bit is set to 1, indicating a read transfer. Next, the device transmits the data byte from the register address being read. After receiving the data byte, the master device transmits a not-acknowledge (NACK) followed by a STOP condition to complete the single-byte data read transfer.

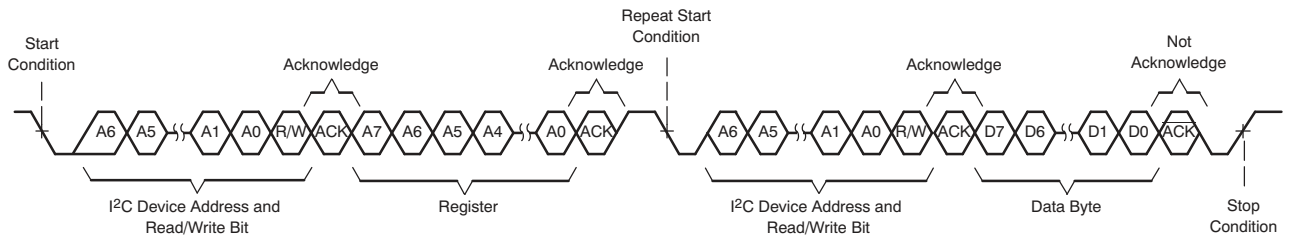

Figure 8-73. I²C Single-Byte Read Transfer

8.5.1.1.2.4 I²C Multiple-Byte Read

As shown in Figure 8-74, a multiple-byte data read transfer is identical to a single-byte data read transfer except that multiple data bytes are transmitted by the device to the master device. With the exception of the last data byte, the master device responds with an acknowledge bit after receiving each data byte. After receiving the last data byte, the master device transmits a not-acknowledge (NACK) followed by a STOP condition to complete the data read transfer.

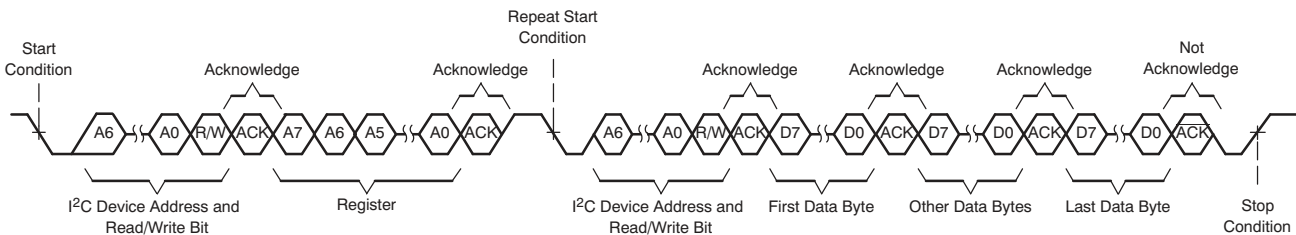

Figure 8-74. I²C Multiple-Byte Read Transfer

8.5.1.2 SPI Control Interface

The general SPI protocol allows full-duplex, synchronous, serial communication between a host processor (the master) and peripheral devices (slaves). The SPI master (in this case, the host processor) generates the synchronizing clock (driven onto SCLK) and initiates transmissions by taking the slave-select pin SSZ from high to low. The SPI slave devices (such as the PCM6480-Q1) depend on a master to start and synchronize transmissions. A transmission begins when initiated by an SPI master. The byte from the SPI master begins shifting in on the slave MOSI pin under the control of the master serial clock (driven onto SCLK). When the byte shifts in on the MOSI pin, a byte shifts out on the MISO pin to the master shift register.

The PCM6480-Q1 support a standard SPI control protocol with a clock polarity setting of 0 (typical microprocessor SPI control bit CPOL = 0) and a clock phase setting of 1 (typical microprocessor SPI control bit CPHA = 1). The SSZ pin can remain low between transmissions; however, the device only interprets the first eight bits transmitted after the falling edge of SSZ as a command byte, and the next eight bits as a data byte only if writing to a register. The device is entirely controlled by registers. Reading and writing these registers is accomplished by an 8-bit command sent to the MOSI pin prior to the data for that register. Table 8-50 shows the command structure. The first seven bits specify the address of the register that is being written or read, from 0 to 127 (decimal). The command word ends with an R/W bit, which specifies the direction of data flow on the serial bus.

In the case of a register write, set the R/W bit to 0. A second byte of data is sent to the MOSI pin and contains the data to be written to the register. A register read is accomplished in a similar fashion. The 8-bit command word sends the 7-bit register address, followed by the R/W bit equal to 1 to signify a register read. The 8-bit register data is then clocked out of the device on the MISO pin during the second eight SCLK clocks in the frame. The device supports sequential SPI addressing for a multiple-byte data write/read transfer until the SSZ pin is pulled high. A multiple-byte data write or read transfer is identical to a single-byte data write or read transfer, respectively, until all data byte transfers complete. The host device must keep the SSZ pin low during all data byte transfers. Figure 8-75 shows the single-byte write transfer and Figure 8-76 illustrates the single-byte read transfer.

Table 8-50. SPI Command Word

| BIT 7 | BIT 6 | BIT 5 | BIT 4 | BIT 3 | BIT 2 | BIT 1 | BIT 0 |
|---------|---------|---------|---------|---------|---------|---------|-------|
| ADDR(6) | ADDR(5) | ADDR(4) | ADDR(3) | ADDR(2) | ADDR(1) | ADDR(0) | R/WZ |

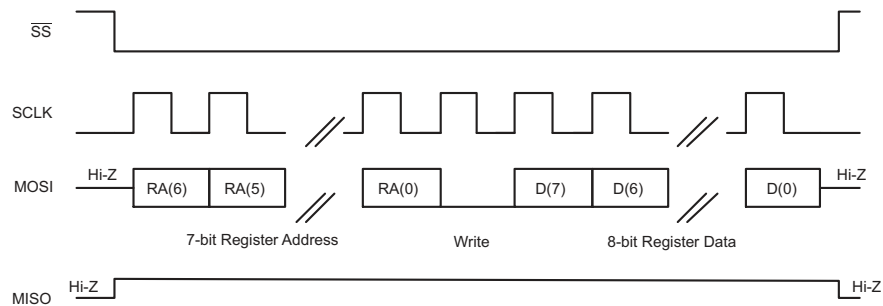

Figure 8-75. SPI Single-Byte Write Transfer

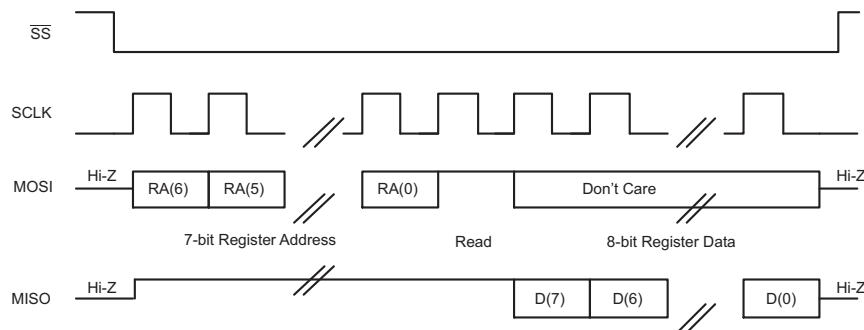

Figure 8-76. SPI Single-Byte Read Transfer

8.6 Register Maps

This section describes the control registers for the device in detail. All registers are eight bits in width and are allocated to the device configuration and programmable coefficients settings. These registers are mapped internally using a page scheme that can be controlled using either I²C or SPI communication to the device. Each page contains 128 bytes of registers. All device configuration registers are stored in page 0, which is the default page setting at power up (and after a software reset). Page 1 consists of the live status registers and input diagnostic SAR data for advanced diagnostic purposes. All programmable coefficient registers are located in page 2, page 3, and page 4. The device current page can be switched to a new desired page by using the PAGE[7:0] bits located in register 0 of every page.

Do not read from or write to reserved pages or reserved registers. Write only default values for the reserved bits in the valid registers.

The procedure for register access across pages is:

- Select page N (write data N to register 0 regardless of the current page number)
- Read or write data from or to valid registers in page N
- Select the new page M (write data M to register 0 regardless of the current page number)
- Read or write data from or to valid registers in page M
- Repeat as needed

8.6.1 Device Configuration Registers

This section describes the device configuration registers for page 0 and page 1.

8.6.1.1 Registers Access Type

Table 8-51 lists the access codes used for the PCM6xx0-Q1 registers.

Table 8-51. PCM6xx0-Q1 Access Type Codes

| ACCESS TYPE | CODE | DESCRIPTION |
|------------------------|------|--|
| Read Type | | |
| R | R | Read |
| R-W | R/W | Read or write |
| Write Type | | |
| W | W | Write |
| Reset or Default Value | | |
| -n | | Value after reset or the default value |

8.6.1.2 Page 0 Registers

Table 8-52 lists the memory-mapped registers for the Page 0 registers. All register offset addresses not listed in Table 8-52 should be considered as reserved locations and the register contents should not be modified.

Table 8-52. PAGE 0 Registers

| Address | Acronym | Register Name | Reset Value | Section |
|---------|-------------|--|-------------|------------------------------------|
| 0x0 | PAGE_CFG | Device page register | 0x00 | Section 8.6.1.2.1 |
| 0x1 | SW_RESET | Software reset register | 0x00 | Section 8.6.1.2.2 |
| 0x2 | SLEEP_CFG | Sleep mode register | 0x00 | Section 8.6.1.2.3 |
| 0x5 | SHDN_CFG | Shutdown configuration register | 0x05 | Section 8.6.1.2.4 |
| 0x7 | ASI_CFG0 | ASI configuration register 0 | 0x30 | Section 8.6.1.2.5 |
| 0x8 | ASI_CFG1 | ASI configuration register 1 | 0x00 | Section 8.6.1.2.6 |
| 0x9 | ASI_CFG2 | ASI configuration register 2 | 0x00 | Section 8.6.1.2.7 |
| 0xB | ASI_CH1 | Channel 1 ASI slot configuration register | 0x00 | Section 8.6.1.2.8 |
| 0xC | ASI_CH2 | Channel 2 ASI slot configuration register | 0x01 | Section 8.6.1.2.9 |
| 0xD | ASI_CH3 | Channel 3 ASI slot configuration register | 0x02 | Section 8.6.1.2.10 |
| 0xE | ASI_CH4 | Channel 4 ASI slot configuration register | 0x03 | Section 8.6.1.2.11 |
| 0xF | ASI_CH5 | Channel 5 ASI slot configuration register | 0x04 | Section 8.6.1.2.12 |
| 0x10 | ASI_CH6 | Channel 6 ASI slot configuration register | 0x05 | Section 8.6.1.2.13 |
| 0x11 | ASI_CH7 | Channel 7 ASI slot configuration register | 0x06 | Section 8.6.1.2.14 |
| 0x12 | ASI_CH8 | Channel 8 ASI slot configuration register | 0x07 | Section 8.6.1.2.15 |
| 0x13 | MST_CFG0 | ASI master mode configuration register 0 | 0x02 | Section 8.6.1.2.16 |
| 0x14 | MST_CFG1 | ASI master mode configuration register 1 | 0x48 | Section 8.6.1.2.17 |
| 0x15 | ASI_STS | ASI bus clock monitor status register | 0xFF | Section 8.6.1.2.18 |
| 0x16 | CLK_SRC | Clock source configuration register | 0x10 | Section 8.6.1.2.19 |
| 0x20 | PDMIN_CFG | PDM DINx sampling edge register | 0x00 | Section 8.6.1.2.20 |
| 0x21 | GPIO_CFG0 | GPIO configuration register 0 | 0x22 | Section 8.6.1.2.21 |
| 0x22 | GPIO_CFG1 | GPIO configuration register 1 | 0x00 | Section 8.6.1.2.22 |
| 0x23 | GPIO_CFG2 | GPIO configuration register 2 | 0x00 | Section 8.6.1.2.23 |
| 0x24 | GPI_CFG0 | GPI configuration register 0 | 0x00 | Section 8.6.1.2.24 |
| 0x25 | GPI_CFG1 | GPI configuration register 1 | 0x00 | Section 8.6.1.2.25 |
| 0x26 | GPIO_VAL | GPIO output value register | 0x00 | Section 8.6.1.2.26 |
| 0x27 | GPIO_MON | GPIO monitor value register | 0x00 | Section 8.6.1.2.27 |
| 0x28 | INT_CFG | Interrupt configuration register | 0x00 | Section 8.6.1.2.28 |
| 0x29 | INT_MASK0 | Interrupt mask register 0 | 0xFF | Section 8.6.1.2.29 |
| 0x2A | INT_MASK1 | Interrupt mask register 1 | 0x03 | Section 8.6.1.2.30 |
| 0x2B | INT_MASK2 | Interrupt mask register 2 | 0x00 | Section 8.6.1.2.31 |
| 0x2C | INT_LTCH0 | Latched interrupt readback register 0 | 0x00 | Section 8.6.1.2.32 |
| 0x2D | CHx_LTCH | Channel diagnostic summary latched status register | 0x00 | Section 8.6.1.2.33 |
| 0x2E | CH1_LTCH | Channel 1 diagnostic latched status register | 0x00 | Section 8.6.1.2.34 |
| 0x2F | CH2_LTCH | Channel 2 diagnostic latched status register | 0x00 | Section 8.6.1.2.35 |
| 0x30 | CH3_LTCH | Channel 3 diagnostic latched status register | 0x00 | Section 8.6.1.2.36 |
| 0x31 | CH4_LTCH | Channel 4 diagnostic latched status register | 0x00 | Section 8.6.1.2.37 |
| 0x34 | INT_MASK3 | Interrupt mask register 3 | 0x00 | Section 8.6.1.2.38 |
| 0x35 | INT_LTCH1 | Latched interrupt readback register 1 | 0x00 | Section 8.6.1.2.39 |
| 0x36 | INT_LTCH2 | Latched interrupt readback register 2 | 0x00 | Section 8.6.1.2.40 |
| 0x37 | INT_LTCH3 | Latched interrupt readback register 3 | 0x00 | Section 8.6.1.2.41 |
| 0x38 | MBDIAG_CFG0 | MICBIAS diagnostic register 0 | 0xBA | Section 8.6.1.2.42 |

Table 8-52. PAGE 0 Registers (continued)

| Address | Acronym | Register Name | Reset Value | Section |
|---------|-------------|---|-------------|------------------------------------|
| 0x39 | MBDIAG_CFG1 | MICBIAS diagnostic register 1 | 0x4B | Section 8.6.1.2.43 |
| 0x3A | MBDIAG_CFG2 | MICBIAS diagnostic register 2 | 0x10 | Section 8.6.1.2.44 |
| 0x3B | BIAS_CFG | Bias configuration register | 0xD0 | Section 8.6.1.2.45 |
| 0x3C | CH1_CFG0 | Channel 1 configuration register 0 | 0x10 | Section 8.6.1.2.46 |
| 0x3D | CH1_CFG1 | Channel 1 configuration register 1 | 0x00 | Section 8.6.1.2.47 |
| 0x3E | CH1_CFG2 | Channel 1 configuration register 2 | 0xC9 | Section 8.6.1.2.48 |
| 0x3F | CH1_CFG3 | Channel 1 configuration register 3 | 0x80 | Section 8.6.1.2.49 |
| 0x40 | CH1_CFG4 | Channel 1 configuration register 4 | 0x00 | Section 8.6.1.2.50 |
| 0x41 | CH2_CFG0 | Channel 2 configuration register 0 | 0x10 | Section 8.6.1.2.51 |
| 0x42 | CH2_CFG1 | Channel 2 configuration register 1 | 0x00 | Section 8.6.1.2.52 |
| 0x43 | CH2_CFG2 | Channel 2 configuration register 2 | 0xC9 | Section 8.6.1.2.53 |
| 0x44 | CH2_CFG3 | Channel 2 configuration register 3 | 0x80 | Section 8.6.1.2.54 |
| 0x45 | CH2_CFG4 | Channel 2 configuration register 4 | 0x00 | Section 8.6.1.2.55 |
| 0x46 | CH3_CFG0 | Channel 3 configuration register 0 | 0x10 | Section 8.6.1.2.56 |
| 0x47 | CH3_CFG1 | Channel 3 configuration register 1 | 0x00 | Section 8.6.1.2.57 |
| 0x48 | CH3_CFG2 | Channel 3 configuration register 2 | 0xC9 | Section 8.6.1.2.58 |
| 0x49 | CH3_CFG3 | Channel 3 configuration register 3 | 0x80 | Section 8.6.1.2.59 |
| 0x4A | CH3_CFG4 | Channel 3 configuration register 4 | 0x00 | Section 8.6.1.2.60 |
| 0x4B | CH4_CFG0 | Channel 4 configuration register 0 | 0x10 | Section 8.6.1.2.61 |
| 0x4C | CH4_CFG1 | Channel 4 configuration register 1 | 0x00 | Section 8.6.1.2.62 |
| 0x4D | CH4_CFG2 | Channel 4 configuration register 2 | 0xC9 | Section 8.6.1.2.63 |
| 0x4E | CH4_CFG3 | Channel 4 configuration register 3 | 0x80 | Section 8.6.1.2.64 |
| 0x4F | CH4_CFG4 | Channel 4 configuration register 4 | 0x00 | Section 8.6.1.2.65 |
| 0x50 | CH5_CFG0 | Channel 5 configuration register 0 | 0x10 | Section 8.6.1.2.66 |
| 0x52 | CH5_CFG2 | Channel 5 configuration register 2 | 0xC9 | Section 8.6.1.2.67 |
| 0x53 | CH5_CFG3 | Channel 5 configuration register 3 | 0x80 | Section 8.6.1.2.68 |
| 0x54 | CH5_CFG4 | Channel 5 configuration register 4 | 0x00 | Section 8.6.1.2.69 |
| 0x55 | CH6_CFG0 | Channel 6 configuration register 0 | 0x10 | Section 8.6.1.2.70 |
| 0x57 | CH6_CFG2 | Channel 6 configuration register 2 | 0xC9 | Section 8.6.1.2.71 |
| 0x58 | CH6_CFG3 | Channel 6 configuration register 3 | 0x80 | Section 8.6.1.2.72 |
| 0x59 | CH6_CFG4 | Channel 6 configuration register 4 | 0x00 | Section 8.6.1.2.73 |
| 0x5A | CH7_CFG0 | Channel 7 configuration register 0 | 0x00 | Section 8.6.1.2.74 |
| 0x5C | CH7_CFG2 | Channel 7 configuration register 2 | 0xC9 | Section 8.6.1.2.75 |
| 0x5D | CH7_CFG3 | Channel 7 configuration register 3 | 0x80 | Section 8.6.1.2.76 |
| 0x5E | CH7_CFG4 | Channel 7 configuration register 4 | 0x00 | Section 8.6.1.2.77 |
| 0x5F | CH8_CFG0 | Channel 8 configuration register 0 | 0x00 | Section 8.6.1.2.78 |
| 0x61 | CH8_CFG2 | Channel 8 configuration register 2 | 0xC9 | Section 8.6.1.2.79 |
| 0x62 | CH8_CFG3 | Channel 8 configuration register 3 | 0x80 | Section 8.6.1.2.80 |
| 0x63 | CH8_CFG4 | Channel 8 configuration register 4 | 0x00 | Section 8.6.1.2.81 |
| 0x64 | DIAG_CFG0 | Input diagnostic configuration register 0 | 0x00 | Section 8.6.1.2.82 |
| 0x65 | DIAG_CFG1 | Input diagnostic configuration register 1 | 0x37 | Section 8.6.1.2.83 |
| 0x66 | DIAG_CFG2 | Input diagnostic configuration register 2 | 0x87 | Section 8.6.1.2.84 |
| 0x67 | DIAG_CFG3 | Input diagnostic configuration register 3 | 0xB8 | Section 8.6.1.2.85 |
| 0x68 | DIAG_CFG4 | Input diagnostic configuration register 4 | 0x00 | Section 8.6.1.2.86 |
| 0x6A | BOOST_CFG | Boost configuration register | 0x00 | Section 8.6.1.2.87 |

Table 8-52. PAGE 0 Registers (continued)

| Address | Acronym | Register Name | Reset Value | Section |
|---------|---------------|--|-------------|------------------------------------|
| 0x6B | DSP_CFG0 | DSP configuration register 0 | 0x01 | Section 8.6.1.2.88 |
| 0x6C | DSP_CFG1 | DSP configuration register 1 | 0x48 | Section 8.6.1.2.89 |
| 0x70 | AGC_CFG0 | AGC configuration register 0 | 0xE7 | Section 8.6.1.2.90 |
| 0x73 | IN_CH_EN | Input channel enable configuration register | 0xFC | Section 8.6.1.2.91 |
| 0x74 | ASI_OUT_CH_EN | ASI output channel enable configuration register | 0x00 | Section 8.6.1.2.92 |
| 0x75 | PWR_CFG | Power up configuration register | 0x00 | Section 8.6.1.2.93 |
| 0x76 | DEV_STS0 | Device status value register 0 | 0x00 | Section 8.6.1.2.94 |
| 0x77 | DEV_STS1 | Device status value register 1 | 0x80 | Section 8.6.1.2.95 |
| 0x7E | I2C_CKSUM | I ² C Checksum | 0x00 | Section 8.6.1.2.96 |

8.6.1.2.1 PAGE_CFG Register (Address = 0x0) [Reset = 0x0]

PAGE_CFG is shown in [Figure 8-77](#) and described in [Table 8-53](#).

Return to the [Table 8-52](#).

The device memory map is divided into pages. This register sets the page.

Figure 8-77. PAGE_CFG Register

| 7 | 6 | 5 | 4 | 3 | 2 | 1 | 0 |
|--------------|---|---|---|---|---|---|---|
| PAGE[7:0] | | | | | | | |
| R/W-0000000b | | | | | | | |

Table 8-53. PAGE_CFG Register Field Descriptions

| Bit | Field | Type | Reset | Description |
|-----|-----------|------|----------|---|
| 7-0 | PAGE[7:0] | R/W | 0000000b | These bits set the device page. 0d = Page 0 1d = Page 1 ... 255d = Page 255 |

8.6.1.2.2 SW_RESET Register (Address = 0x1) [Reset = 0x0]

SW_RESET is shown in [Figure 8-78](#) and described in [Table 8-54](#).

Return to the [Table 8-52](#).

This register is the software reset register. Asserting a software reset places all register values in their default power-on-reset (POR) state.

Figure 8-78. SW_RESET Register

| 7 | 6 | 5 | 4 | 3 | 2 | 1 | 0 |
|------------|---|---|---|---|---|---|----------|
| RESERVED | | | | | | | SW_RESET |
| R-0000000b | | | | | | | R/W-0b |

Table 8-54. SW_RESET Register Field Descriptions

| Bit | Field | Type | Reset | Description |
|-----|----------|------|----------|---|
| 7-1 | RESERVED | R | 0000000b | Reserved bits; Write only reset value |
| 0 | SW_RESET | R/W | 0b | Software reset. This bit is self-clearing. 0d = Do not reset 1d = Reset |

8.6.1.2.3 SLEEP_CFG Register (Address = 0x2) [Reset = 0x0]

SLEEP_CFG is shown in [Figure 8-79](#) and described in [Table 8-55](#).

Return to the [Table 8-52](#).

This register configures the regulator, VREF quick charge, I²C broadcast and sleep mode.

Figure 8-79. SLEEP_CFG Register

| 7 | 6 | 5 | 4 | 3 | 2 | 1 | 0 |
|----------|----------|---|----------------|---|----------------|----------|-----------|
| RESERVED | RESERVED | | VREF_QCHG[1:0] | | I2C_BRDCAST_EN | RESERVED | SLEEP_ENZ |
| R/W-0b | R/W-00b | | R/W-00b | | R/W-0b | R-0b | R/W-0b |

Table 8-55. SLEEP_CFG Register Field Descriptions

| Bit | Field | Type | Reset | Description |
|-----|----------------|------|-------|--|
| 7 | RESERVED | R/W | 0b | Reserved bit; Write only reset value |
| 6-5 | RESERVED | R/W | 00b | Reserved bits; Write only reset values |
| 4-3 | VREF_QCHG[1:0] | R/W | 00b | The duration of the quick-charge for the VREF external capacitor is set using an internal series impedance of 200 Ω. 0d = VREF quick-charge duration of 3.5 ms (typical) 1d = VREF quick-charge duration of 10 ms (typical) 2d = VREF quick-charge duration of 50 ms (typical) 3d = VREF quick-charge duration of 100 ms (typical) |
| 2 | I2C_BRDCAST_EN | R/W | 0b | I ² C broadcast addressing setting. 0d = I ² C broadcast mode disabled; the I ² C slave address is determined based on the ADDR pins 1d = I ² C broadcast mode enabled; the I ² C slave address is fixed at 1001 100 |
| 1 | RESERVED | R | 0b | Reserved bit; Write only reset value |
| 0 | SLEEP_ENZ | R/W | 0b | Sleep mode setting. 0d = Device is in sleep mode 1d = Device is not in sleep mode |

8.6.1.2.4 SHDN_CFG Register (Address = 0x5) [Reset = 0x5]

SHDN_CFG is shown in [Figure 8-80](#) and described in [Table 8-56](#).

Return to the [Table 8-52](#).

This register configures the device shutdown

Figure 8-80. SHDN_CFG Register

| 7 | 6 | 5 | 4 | 3 | 2 | 1 | 0 |
|----------|---|---|---|----------------|---|-------------------|---|
| RESERVED | | | | SHDNZ_CFG[1:0] | | DREG_KA_TIME[1:0] | |
| R-0000b | | | | R/W-01b | | R/W-01b | |

Table 8-56. SHDN_CFG Register Field Descriptions

| Bit | Field | Type | Reset | Description |
|-----|----------------|------|-------|---|
| 7-4 | RESERVED | R | 0000b | Reserved bits; Write only reset value |
| 3-2 | SHDNZ_CFG[1:0] | R/W | 01b | Shutdown configuration. 0d = DREG is powered down immediately after SHDNZ asserts 1d = DREG remains active to enable a clean shut down until a time-out is reached; after the time-out period, DREG is forced to power off 2d = DREG remains active until the device cleanly shuts down 3d = Reserved |

Table 8-56. SHDN_CFG Register Field Descriptions (continued)

| Bit | Field | Type | Reset | Description |
|-----|-------------------|------|-------|---|
| 1-0 | DREG_KA_TIME[1:0] | R/W | 01b | These bits set how long DREG remains active after SHDNZ asserts. 0d = DREG remains active for 30 ms (typical) 1d = DREG remains active for 25 ms (typical) 2d = DREG remains active for 10 ms (typical) 3d = DREG remains active for 5 ms (typical) |

8.6.1.2.5 ASI_CFG0 Register (Address = 0x7) [Reset = 0x30]

ASI_CFG0 is shown in [Figure 8-81](#) and described in [Table 8-57](#).

Return to the [Table 8-52](#).

This register is the ASI configuration register 0.

Figure 8-81. ASI_CFG0 Register

| 7 | 6 | 5 | 4 | 3 | 2 | 1 | 0 |
|-----------------|---|---------------|---|-----------|----------|---------|---------|
| ASI_FORMAT[1:0] | | ASI_WLEN[1:0] | | FSYNC_POL | BCLK_POL | TX_EDGE | TX_FILL |
| R/W-00b | | R/W-11b | | R/W-0b | R/W-0b | R/W-0b | R/W-0b |

Table 8-57. ASI_CFG0 Register Field Descriptions

| Bit | Field | Type | Reset | Description |
|-----|-----------------|------|-------|---|
| 7-6 | ASI_FORMAT[1:0] | R/W | 00b | ASI protocol format. 0d = TDM mode 1d = I ² S mode 2d = LJ (left-justified) mode 3d = Reserved |
| 5-4 | ASI_WLEN[1:0] | R/W | 11b | ASI word or slot length. 0d = 16 bits 1d = 20 bits 2d = 24 bits 3d = 32 bits |
| 3 | FSYNC_POL | R/W | 0b | ASI FSYNC polarity. 0d = Default polarity as per standard protocol 1d = Inverted polarity with respect to standard protocol |
| 2 | BCLK_POL | R/W | 0b | ASI BCLK polarity. 0d = Default polarity as per standard protocol 1d = Inverted polarity with respect to standard protocol |
| 1 | TX_EDGE | R/W | 0b | ASI data output (on the primary and secondary data pin) transmit edge. 0d = Default edge as per the protocol configuration setting in bit 2 (BCLK_POL) 1d = Inverted following edge (half cycle delay) with respect to the default edge setting |
| 0 | TX_FILL | R/W | 0b | ASI data output (on the primary and secondary data pin) for any unused cycles 0d = Always transmit 0 for unused cycles 1d = Always use Hi-Z for unused cycles |

8.6.1.2.6 ASI_CFG1 Register (Address = 0x8) [Reset = 0x0]

ASI_CFG1 is shown in [Figure 8-82](#) and described in [Table 8-58](#).

Return to the [Table 8-52](#).

This register is the ASI configuration register 1.

Figure 8-82. ASI_CFG1 Register

| 7 | 6 | 5 | 4 | 3 | 2 | 1 | 0 |
|---|---|---|---|---|---|---|---|
|---|---|---|---|---|---|---|---|

Figure 8-82. ASI_CFG1 Register (continued)

| | | |
|--------|----------------|----------------|
| TX_LSB | TX_KEEPER[1:0] | TX_OFFSET[4:0] |
| R/W-0b | R/W-00b | R/W-00000b |

Table 8-58. ASI_CFG1 Register Field Descriptions

| Bit | Field | Type | Reset | Description |
|-----|----------------|------|--------|--|
| 7 | TX_LSB | R/W | 0b | ASI data output (on the primary and secondary data pin) for LSB transmissions. 0d = Transmit the LSB for a full cycle 1d = Transmit the LSB for the first half cycle and Hi-Z for the second half cycle |
| 6-5 | TX_KEEPER[1:0] | R/W | 00b | ASI data output (on the primary and secondary data pin) bus keeper. 0d = Bus keeper is always disabled 1d = Bus keeper is always enabled 2d = Bus keeper is enabled during LSB transmissions only for one cycle 3d = Bus keeper is enabled during LSB transmissions only for one and half cycles |
| 4-0 | TX_OFFSET[4:0] | R/W | 00000b | ASI data MSB slot 0 offset (on the primary and secondary data pin). 0d = ASI data MSB location has no offset and is as per standard protocol 1d = ASI data MSB location (TDM mode is slot 0 or I ² S, LJ mode is the left and right slot 0) offset of one BCLK cycle with respect to standard protocol 2d = ASI data MSB location (TDM mode is slot 0 or I ² S, LJ mode is the left and right slot 0) offset of two BCLK cycles with respect to standard protocol 3d to 30d = ASI data MSB location (TDM mode is slot 0 or I ² S, LJ mode is the left and right slot 0) offset assigned as per configuration 31d = ASI data MSB location (TDM mode is slot 0 or I ² S, LJ mode is the left and right slot 0) offset of 31 BCLK cycles with respect to standard protocol |

8.6.1.2.7 ASI_CFG2 Register (Address = 0x9) [Reset = 0x0]

ASI_CFG2 is shown in [Figure 8-83](#) and described in [Table 8-59](#).

Return to the [Table 8-52](#).

This register is the ASI configuration register 2.

Figure 8-83. ASI_CFG2 Register

| | | | | | | | |
|-----------|----------|---------|--------------|----------|---|---|---|
| 7 | 6 | 5 | 4 | 3 | 2 | 1 | 0 |
| ASI_DAI5Y | RESERVED | ASI_ERR | ASI_ERR_RCOV | RESERVED | | | |
| R/W-0b | R-0b | R/W-0b | R/W-0b | R-0000b | | | |

Table 8-59. ASI_CFG2 Register Field Descriptions

| Bit | Field | Type | Reset | Description |
|-----|--------------|------|-------|--|
| 7 | ASI_DAI5Y | R/W | 0b | ASI daisy chain connection. 0d = All devices are connected in the common ASI bus 1d = All devices are daisy-chained for the ASI bus |
| 6 | RESERVED | R | 0b | Reserved bit; Write only reset value |
| 5 | ASI_ERR | R/W | 0b | ASI bus error detection. 0d = Enable bus error detection 1d = Disable bus error detection |
| 4 | ASI_ERR_RCOV | R/W | 0b | ASI bus error auto resume. 0d = Enable auto resume after bus error recovery 1d = Disable auto resume after bus error recovery and remain powered down until the host configures the device |

Table 8-59. ASI_CFG2 Register Field Descriptions (continued)

| Bit | Field | Type | Reset | Description |
|-----|----------|------|-------|---------------------------------------|
| 3-0 | RESERVED | R | 0000b | Reserved bits; Write only reset value |

8.6.1.2.8 ASI_CH1 Register (Address = 0xB) [Reset = 0x0]

ASI_CH1 is shown in [Figure 8-84](#) and described in [Table 8-60](#).

Return to the [Table 8-52](#).

This register is the ASI slot configuration register for channel 1.

Figure 8-84. ASI_CH1 Register

| 7 | 6 | 5 | 4 | 3 | 2 | 1 | 0 |
|----------|------------|---------------|---|---|---|---|---|
| RESERVED | CH1_OUTPUT | CH1_SLOT[5:0] | | | | | |
| R-0b | R/W-0b | R/W-000000b | | | | | |

Table 8-60. ASI_CH1 Register Field Descriptions

| Bit | Field | Type | Reset | Description |
|-----|---------------|------|---------|--|
| 7 | RESERVED | R | 0b | Reserved bit; Write only reset value |
| 6 | CH1_OUTPUT | R/W | 0b | Channel 1 output line. 0d = Channel 1 output is on the ASI primary output pin (SDOUT) 1d = Channel 1 output is on the ASI secondary output pin (GPIO1 or GPOx) |
| 5-0 | CH1_SLOT[5:0] | R/W | 000000b | Channel 1 slot assignment. 0d = TDM is slot 0 or I ² S, LJ is left slot 0 1d = TDM is slot 1 or I ² S, LJ is left slot 1 2d to 30d = Slot assigned as per configuration 31d = TDM is slot 31 or I ² S, LJ is left slot 31 32d = TDM is slot 32 or I ² S, LJ is right slot 0 33d = TDM is slot 33 or I ² S, LJ is right slot 1 34d to 62d = Slot assigned as per configuration 63d = TDM is slot 63 or I ² S, LJ is right slot 31 |

8.6.1.2.9 ASI_CH2 Register (Address = 0xC) [Reset = 0x1]

ASI_CH2 is shown in [Figure 8-85](#) and described in [Table 8-61](#).

Return to the [Table 8-52](#).

This register is the ASI slot configuration register for channel 2.

Figure 8-85. ASI_CH2 Register

| 7 | 6 | 5 | 4 | 3 | 2 | 1 | 0 |
|----------|------------|---------------|---|---|---|---|---|
| RESERVED | CH2_OUTPUT | CH2_SLOT[5:0] | | | | | |
| R-0b | R/W-0b | R/W-000001b | | | | | |

Table 8-61. ASI_CH2 Register Field Descriptions

| Bit | Field | Type | Reset | Description |
|-----|------------|------|-------|--|
| 7 | RESERVED | R | 0b | Reserved bit; Write only reset value |
| 6 | CH2_OUTPUT | R/W | 0b | Channel 2 output line. 0d = Channel 2 output is on the ASI primary output pin (SDOUT) 1d = Channel 2 output is on the ASI secondary output pin (GPIO1 or GPOx) |

Table 8-61. ASI_CH2 Register Field Descriptions (continued)

| Bit | Field | Type | Reset | Description |
|-----|---------------|------|---------|--|
| 5-0 | CH2_SLOT[5:0] | R/W | 000001b | Channel 2 slot assignment. 0d = TDM is slot 0 or I ² S, LJ is left slot 0 1d = TDM is slot 1 or I ² S, LJ is left slot 1 2d to 30d = Slot assigned as per configuration 31d = TDM is slot 31 or I ² S, LJ is left slot 31 32d = TDM is slot 32 or I ² S, LJ is right slot 0 33d = TDM is slot 33 or I ² S, LJ is right slot 1 34d to 62d = Slot assigned as per configuration 63d = TDM is slot 63 or I ² S, LJ is right slot 31 |

8.6.1.2.10 ASI_CH3 Register (Address = 0xD) [Reset = 0x2]

ASI_CH3 is shown in [Figure 8-86](#) and described in [Table 8-62](#).

Return to the [Table 8-52](#).

This register is the ASI slot configuration register for channel 3.

Figure 8-86. ASI_CH3 Register

| 7 | 6 | 5 | 4 | 3 | 2 | 1 | 0 | |
|----------|------------|---------------|---|---|---|---|---|--|
| RESERVED | CH3_OUTPUT | CH3_SLOT[5:0] | | | | | | |
| R-0b | R/W-0b | R/W-000010b | | | | | | |

Table 8-62. ASI_CH3 Register Field Descriptions

| Bit | Field | Type | Reset | Description |
|-----|---------------|------|---------|--|
| 7 | RESERVED | R | 0b | Reserved bit; Write only reset value |
| 6 | CH3_OUTPUT | R/W | 0b | Channel 3 output line. 0d = Channel 3 output is on the ASI primary output pin (SDOUT) 1d = Channel 3 output is on the ASI secondary output pin (GPIO1 or GPOx) |
| 5-0 | CH3_SLOT[5:0] | R/W | 000010b | Channel 3 slot assignment. 0d = TDM is slot 0 or I ² S, LJ is left slot 0 1d = TDM is slot 1 or I ² S, LJ is left slot 1 2d to 30d = Slot assigned as per configuration 31d = TDM is slot 31 or I ² S, LJ is left slot 31 32d = TDM is slot 32 or I ² S, LJ is right slot 0 33d = TDM is slot 33 or I ² S, LJ is right slot 1 34d to 62d = Slot assigned as per configuration 63d = TDM is slot 63 or I ² S, LJ is right slot 31 |

8.6.1.2.11 ASI_CH4 Register (Address = 0xE) [Reset = 0x3]

ASI_CH4 is shown in [Figure 8-87](#) and described in [Table 8-63](#).

Return to the [Table 8-52](#).

This register is the ASI slot configuration register for channel 4.

Figure 8-87. ASI_CH4 Register

| 7 | 6 | 5 | 4 | 3 | 2 | 1 | 0 | |
|----------|------------|---------------|---|---|---|---|---|--|
| RESERVED | CH4_OUTPUT | CH4_SLOT[5:0] | | | | | | |
| R-0b | R/W-0b | R/W-000011b | | | | | | |

Table 8-63. ASI_CH4 Register Field Descriptions

| Bit | Field | Type | Reset | Description |
|-----|----------|------|-------|--------------------------------------|
| 7 | RESERVED | R | 0b | Reserved bit; Write only reset value |

Table 8-63. ASI_CH4 Register Field Descriptions (continued)

| Bit | Field | Type | Reset | Description |
|-----|---------------|------|---------|--|
| 6 | CH4_OUTPUT | R/W | 0b | Channel 4 output line. 0d = Channel 4 output is on the ASI primary output pin (SDOUT) 1d = Channel 4 output is on the ASI secondary output pin (GPIO1 or GPOx) |
| 5-0 | CH4_SLOT[5:0] | R/W | 000011b | Channel 4 slot assignment. 0d = TDM is slot 0 or I ² S, LJ is left slot 0 1d = TDM is slot 1 or I ² S, LJ is left slot 1 2d to 30d = Slot assigned as per configuration 31d = TDM is slot 31 or I ² S, LJ is left slot 31 32d = TDM is slot 32 or I ² S, LJ is right slot 0 33d = TDM is slot 33 or I ² S, LJ is right slot 1 34d to 62d = Slot assigned as per configuration 63d = TDM is slot 63 or I ² S, LJ is right slot 31 |

8.6.1.2.12 ASI_CH5 Register (Address = 0xF) [Reset = 0x4]

ASI_CH5 is shown in [Figure 8-88](#) and described in [Table 8-64](#).

Return to the [Table 8-52](#).

This register is the ASI slot configuration register for channel 5.

Figure 8-88. ASI_CH5 Register

| 7 | 6 | 5 | 4 | 3 | 2 | 1 | 0 |
|----------|------------|---------------|---|---|---|---|---|
| RESERVED | CH5_OUTPUT | CH5_SLOT[5:0] | | | | | |
| R-0b | R/W-0b | R/W-000100b | | | | | |

Table 8-64. ASI_CH5 Register Field Descriptions

| Bit | Field | Type | Reset | Description |
|-----|---------------|------|---------|--|
| 7 | RESERVED | R | 0b | Reserved bit; Write only reset value |
| 6 | CH5_OUTPUT | R/W | 0b | Channel 5 output line. 0d = Channel 5 output is on the ASI primary output pin (SDOUT) 1d = Channel 5 output is on the ASI secondary output pin (GPIO1 or GPOx) |
| 5-0 | CH5_SLOT[5:0] | R/W | 000100b | Channel 5 slot assignment. 0d = TDM is slot 0 or I ² S, LJ is left slot 0 1d = TDM is slot 1 or I ² S, LJ is left slot 1 2d to 30d = Slot assigned as per configuration 31d = TDM is slot 31 or I ² S, LJ is left slot 31 32d = TDM is slot 32 or I ² S, LJ is right slot 0 33d = TDM is slot 33 or I ² S, LJ is right slot 1 34d to 62d = Slot assigned as per configuration 63d = TDM is slot 63 or I ² S, LJ is right slot 31 |

8.6.1.2.13 ASI_CH6 Register (Address = 0x10) [Reset = 0x5]

ASI_CH6 is shown in [Figure 8-89](#) and described in [Table 8-65](#).

Return to the [Table 8-52](#).

This register is the ASI slot configuration register for channel 6.

Figure 8-89. ASI_CH6 Register

| 7 | 6 | 5 | 4 | 3 | 2 | 1 | 0 |
|----------|------------|---------------|---|---|---|---|---|
| RESERVED | CH6_OUTPUT | CH6_SLOT[5:0] | | | | | |
| R-0b | R/W-0b | R/W-000101b | | | | | |

Table 8-65. ASI_CH6 Register Field Descriptions

| Bit | Field | Type | Reset | Description |
|-----|---------------|------|---------|--|
| 7 | RESERVED | R | 0b | Reserved bit; Write only reset value |
| 6 | CH6_OUTPUT | R/W | 0b | Channel 6 output line. 0d = Channel 6 output is on the ASI primary output pin (SDOUT) 1d = Channel 6 output is on the ASI secondary output pin (GPIO1 or GPOx) |
| 5-0 | CH6_SLOT[5:0] | R/W | 000101b | Channel 6 slot assignment. 0d = TDM is slot 0 or I ² S, LJ is left slot 0 1d = TDM is slot 1 or I ² S, LJ is left slot 1 2d to 30d = Slot assigned as per configuration 31d = TDM is slot 31 or I ² S, LJ is left slot 31 32d = TDM is slot 32 or I ² S, LJ is right slot 0 33d = TDM is slot 33 or I ² S, LJ is right slot 1 34d to 62d = Slot assigned as per configuration 63d = TDM is slot 63 or I ² S, LJ is right slot 31 |

8.6.1.2.14 ASI_CH7 Register (Address = 0x11) [Reset = 0x6]

ASI_CH7 is shown in [Figure 8-90](#) and described in [Table 8-66](#).

Return to the [Table 8-52](#).

This register is the ASI slot configuration register for channel 7.

Figure 8-90. ASI_CH7 Register

| 7 | 6 | 5 | 4 | 3 | 2 | 1 | 0 |
|----------|------------|---------------|---|---|---|---|---|
| RESERVED | CH7_OUTPUT | CH7_SLOT[5:0] | | | | | |
| R-0b | R/W-0b | R/W-000110b | | | | | |

Table 8-66. ASI_CH7 Register Field Descriptions

| Bit | Field | Type | Reset | Description |
|-----|---------------|------|---------|--|
| 7 | RESERVED | R | 0b | Reserved bit; Write only reset value |
| 6 | CH7_OUTPUT | R/W | 0b | Channel 7 output line. 0d = Channel 7 output is on the ASI primary output pin (SDOUT) 1d = Channel 7 output is on the ASI secondary output pin (GPIO1 or GPOx) |
| 5-0 | CH7_SLOT[5:0] | R/W | 000110b | Channel 7 slot assignment. 0d = TDM is slot 0 or I ² S, LJ is left slot 0 1d = TDM is slot 1 or I ² S, LJ is left slot 1 2d to 30d = Slot assigned as per configuration 31d = TDM is slot 31 or I ² S, LJ is left slot 31 32d = TDM is slot 32 or I ² S, LJ is right slot 0 33d = TDM is slot 33 or I ² S, LJ is right slot 1 34d to 62d = Slot assigned as per configuration 63d = TDM is slot 63 or I ² S, LJ is right slot 31 |

8.6.1.2.15 ASI_CH8 Register (Address = 0x12) [Reset = 0x7]

ASI_CH8 is shown in [Figure 8-91](#) and described in [Table 8-67](#).

Return to the [Table 8-52](#).

This register is the ASI slot configuration register for channel 8.

Figure 8-91. ASI_CH8 Register

| 7 | 6 | 5 | 4 | 3 | 2 | 1 | 0 |
|----------|------------|---------------|---|---|---|---|---|
| RESERVED | CH8_OUTPUT | CH8_SLOT[5:0] | | | | | |
| R-0b | R/W-0b | R/W-000111b | | | | | |

Figure 8-91. ASI_CH8 Register (continued)

Table 8-67. ASI_CH8 Register Field Descriptions

| Bit | Field | Type | Reset | Description |
|-----|---------------|------|---------|--|
| 7 | RESERVED | R | 0b | Reserved bit; Write only reset value |
| 6 | CH8_OUTPUT | R/W | 0b | Channel 8 output line. 0d = Channel 8 output is on the ASI primary output pin (SDOUT) 1d = Channel 8 output is on the ASI secondary output pin (GPIO1 or GPOx) |
| 5-0 | CH8_SLOT[5:0] | R/W | 000111b | Channel 8 slot assignment. 0d = TDM is slot 0 or I ² S, LJ is left slot 0 1d = TDM is slot 1 or I ² S, LJ is left slot 1 2d to 30d = Slot assigned as per configuration 31d = TDM is slot 31 or I ² S, LJ is left slot 31 32d = TDM is slot 32 or I ² S, LJ is right slot 0 33d = TDM is slot 33 or I ² S, LJ is right slot 1 34d to 62d = Slot assigned as per configuration 63d = TDM is slot 63 or I ² S, LJ is right slot 31 |

8.6.1.2.16 MST_CFG0 Register (Address = 0x13) [Reset = 0x2]

MST_CFG0 is shown in Figure 8-92 and described in Table 8-68.

Return to the Table 8-52.

This register is the ASI master mode configuration register 0.

Figure 8-92. MST_CFG0 Register

| 7 | 6 | 5 | 4 | 3 | 2 | 1 | 0 |
|-------------|-------------------|-----------------------|---------------------|---------|--------------------|---|---|
| MST_SLV_CFG | AUTO_CLK_CFG G | AUTO_MODE_ PLL_DIS | BCLK_FSYNC_ GATE | FS_MODE | MCLK_FREQ_SEL[2:0] | | |
| R/W-0b | R/W-0b | R/W-0b | R/W-0b | R/W-0b | R/W-010b | | |

Table 8-68. MST_CFG0 Register Field Descriptions

| Bit | Field | Type | Reset | Description |
|-----|-------------------|------|-------|--|
| 7 | MST_SLV_CFG | R/W | 0b | ASI master or slave configuration register setting. 0d = Device is in slave mode (both BCLK and FSYNC are inputs to the device) 1d = Device is in master mode (both BCLK and FSYNC are generated from the device) |
| 6 | AUTO_CLK_CFG | R/W | 0b | Automatic clock configuration setting. 0d = Auto clock configuration is enabled (all internal clock divider and PLL configurations are auto derived) 1d = Auto clock configuration is disabled (custom mode and device GUI must be used for the device configuration settings) |
| 5 | AUTO_MODE_PLL_DIS | R/W | 0b | Automatic mode PLL setting. 0d = PLL is enabled in auto clock configuration 1d = PLL is disabled in auto clock configuration |
| 4 | BCLK_FSYNC_GATE | R/W | 0b | BCLK and FSYNC clock gate (valid when the device is in master mode). 0d = Do not gate BCLK and FSYNC 1d = Force gate BCLK and FSYNC when being transmitted from the device in master mode |
| 3 | FS_MODE | R/W | 0b | Sample rate setting (valid when the device is in master mode). 0d = f_s is a multiple (or submultiple) of 48 kHz 1d = f_s is a multiple (or submultiple) of 44.1 kHz |

Table 8-68. MST_CFG0 Register Field Descriptions (continued)

| Bit | Field | Type | Reset | Description |
|-----|--------------------|------|-------|---|
| 2-0 | MCLK_FREQ_SEL[2:0] | R/W | 010b | These bits select the MCLK (GPIO or GPIx) frequency for the PLL source clock input (valid when the device is in master mode and MCLK_FREQ_SEL_MODE = 0). 0d = 12 MHz 1d = 12.288 MHz 2d = 13 MHz 3d = 16 MHz 4d = 19.2 MHz 5d = 19.68 MHz 6d = 24 MHz 7d = 24.576 MHz |

8.6.1.2.17 MST_CFG1 Register (Address = 0x14) [Reset = 0x48]

MST_CFG1 is shown in [Figure 8-93](#) and described in [Table 8-69](#).

Return to the [Table 8-52](#).

This register is the ASI master mode configuration register 1.

Figure 8-93. MST_CFG1 Register

| 7 | 6 | 5 | 4 | 3 | 2 | 1 | 0 |
|--------------|---|---|---|--------------------|---|---|---|
| FS_RATE[3:0] | | | | FS_BCLK_RATIO[3:0] | | | |
| R/W-0100b | | | | R/W-1000b | | | |

Table 8-69. MST_CFG1 Register Field Descriptions

| Bit | Field | Type | Reset | Description |
|-----|--------------------|------|-------|--|
| 7-4 | FS_RATE[3:0] | R/W | 0100b | Programmed sample rate of the ASI bus (not used when the device is configured in slave mode auto clock configuration). 0d = 7.35 kHz or 8 kHz 1d = 14.7 kHz or 16 kHz 2d = 22.05 kHz or 24 kHz 3d = 29.4 kHz or 32 kHz 4d = 44.1 kHz or 48 kHz 5d = 88.2 kHz or 96 kHz 6d = 176.4 kHz or 192 kHz 7d = 352.8 kHz or 384 kHz 8d = 705.6 kHz or 768 kHz 9d to 15d = Reserved |
| 3-0 | FS_BCLK_RATIO[3:0] | R/W | 1000b | Programmed BCLK to FSYNC frequency ratio of the ASI bus (not used when the device is configured in slave mode auto clock configuration). 0d = Ratio of 16 1d = Ratio of 24 2d = Ratio of 32 3d = Ratio of 48 4d = Ratio of 64 5d = Ratio of 96 6d = Ratio of 128 7d = Ratio of 192 8d = Ratio of 256 9d = Ratio of 384 10d = Ratio of 512 11d = Ratio of 1024 12d = Ratio of 2048 13d = Reserved 14d = Reserved 15d = Reserved |

8.6.1.2.18 ASI_STS Register (Address = 0x15) [Reset = 0xFF]

ASI_STS is shown in [Figure 8-94](#) and described in [Table 8-70](#).

Return to the [Table 8-52](#).

This register is the ASI bus clock monitor status register

Figure 8-94. ASI_STS Register

| | | | | | | | |
|------------------|---|---|---|-------------------|---|---|---|
| 7 | 6 | 5 | 4 | 3 | 2 | 1 | 0 |
| FS_RATE_STS[3:0] | | | | FS_RATIO_STS[3:0] | | | |
| R-1111b | | | | R-1111b | | | |

Table 8-70. ASI_STS Register Field Descriptions

| Bit | Field | Type | Reset | Description |
|-----|-------------------|------|-------|---|
| 7-4 | FS_RATE_STS[3:0] | R | 1111b | Detected sample rate of the ASI bus. 0d = 7.35 kHz or 8 kHz 1d = 14.7 kHz or 16 kHz 2d = 22.05 kHz or 24 kHz 3d = 29.4 kHz or 32 kHz 4d = 44.1 kHz or 48 kHz 5d = 88.2 kHz or 96 kHz 6d = 176.4 kHz or 192 kHz 7d = 352.8 kHz or 384 kHz 8d = 705.6 kHz or 768 kHz 9d to 14d = Reserved 15d = Invalid sample rate |
| 3-0 | FS_RATIO_STS[3:0] | R | 1111b | Detected BCLK to FSYNC frequency ratio of the ASI bus. 0d = Ratio of 16 1d = Ratio of 24 2d = Ratio of 32 3d = Ratio of 48 4d = Ratio of 64 5d = Ratio of 96 6d = Ratio of 128 7d = Ratio of 192 8d = Ratio of 256 9d = Ratio of 384 10d = Ratio of 512 11d = Ratio of 1024 12d = Ratio of 2048 13d = Reserved 14d = Reserved 15d = Invalid ratio |

8.6.1.2.19 CLK_SRC Register (Address = 0x16) [Reset = 0x10]

CLK_SRC is shown in [Figure 8-95](#) and described in [Table 8-71](#).

Return to the [Table 8-52](#).

This register is the clock source configuration register.

Figure 8-95. CLK_SRC Register

| | | | | | | | |
|-------------------------|------------------------|---------------------|---|---|----------|---|---|
| 7 | 6 | 5 | 4 | 3 | 2 | 1 | 0 |
| DIS_PLL_SLV_ CLK_SRC | MCLK_FREQ_ SEL_MODE | MCLK_RATIO_SEL[2:0] | | | RESERVED | | |
| R/W-0b | R/W-0b | R/W-010b | | | R-000b | | |

Table 8-71. CLK_SRC Register Field Descriptions

| Bit | Field | Type | Reset | Description |
|-----|---------------------|------|-------|--|
| 7 | DIS_PLL_SLV_CLK_SRC | R/W | 0b | Audio root clock source setting when the device is configured with the PLL disabled in the auto clock configuration for slave mode (AUTO_MODE_PLL_DIS = 1). 0d = BCLK is used as the audio root clock source 1d = MCLK (GPIOx or GPIx) is used as the audio root clock source (the MCLK to FSYNC ratio is as per MCLK_RATIO_SEL setting) |
| 6 | MCLK_FREQ_SEL_MODE | R/W | 0b | Master mode MCLK (GPIOx or GPIx) frequency selection mode (valid when the device is in auto clock configuration). 0d = MCLK frequency is based on the MCLK_FREQ_SEL (P0_R19) configuration 1d = MCLK frequency is specified as a multiple of FSYNC in the MCLK_RATIO_SEL (P0_R22) configuration |
| 5-3 | MCLK_RATIO_SEL[2:0] | R/W | 010b | These bits select the MCLK (GPIOx or GPIx) to FSYNC ratio for master mode or when MCLK is used as the audio root clock source in slave mode. 0d = Ratio of 64 1d = Ratio of 256 2d = Ratio of 384 3d = Ratio of 512 4d = Ratio of 768 5d = Ratio of 1024 6d = Ratio of 1536 7d = Ratio of 2304 |
| 2-0 | RESERVED | R | 000b | Reserved bits; Write only reset values |

8.6.1.2.20 PDMIN_CFG Register (Address = 0x20) [Reset = 0x0]

PDMIN_CFG is shown in [Figure 8-96](#) and described in [Table 8-72](#).

Return to the [Table 8-52](#).

This register is the PDM DINx sampling edge configuration register.

Figure 8-96. PDMIN_CFG Register

| 7 | 6 | 5 | 4 | 3 | 2 | 1 | 0 |
|----------|---|-------------|-------------|---|---|----------|---|
| RESERVED | | PDMIN1_EDGE | PDMIN2_EDGE | | | RESERVED | |
| R-00b | | R/W-0b | R/W-0b | | | R-0000b | |

Table 8-72. PDMIN_CFG Register Field Descriptions

| Bit | Field | Type | Reset | Description |
|-----|-------------|------|-------|---|
| 7-6 | RESERVED | R | 00b | Reserved bits; Write only reset value |
| 5 | PDMIN1_EDGE | R/W | 0b | PDMCLK latching edge used for channel 5 and channel 6 data. 0d = Channel 5 data are latched on the negative edge, channel 6 data are latched on the positive edge 1d = Channel 5 data are latched on the positive edge, channel 6 data are latched on the negative edge |
| 4 | PDMIN2_EDGE | R/W | 0b | PDMCLK latching edge used for channel 7 and channel 8 data. 0d = Channel 7 data are latched on the negative edge, channel 8 data are latched on the positive edge 1d = Channel 7 data are latched on the positive edge, channel 8 data are latched on the negative edge |
| 3-0 | RESERVED | R | 0000b | Reserved bits; Write only reset value |

8.6.1.2.21 GPIO_CFG0 Register (Address = 0x21) [Reset = 0x22]

GPIO_CFG0 is shown in [Figure 8-97](#) and described in [Table 8-73](#).

Return to the [Table 8-52](#).

This register is the GPIO configuration register 0.

Figure 8-97. GPIO_CFG0 Register

| | | | | | | | |
|----------------|---|---|---|----------|----------------|---|---|
| 7 | 6 | 5 | 4 | 3 | 2 | 1 | 0 |
| GPIO1_CFG[3:0] | | | | RESERVED | GPIO1_DRV[2:0] | | |
| R/W-0010b | | | | R-0b | R/W-010b | | |

Table 8-73. GPIO_CFG0 Register Field Descriptions

| Bit | Field | Type | Reset | Description |
|-----|----------------|------|-------|--|
| 7-4 | GPIO1_CFG[3:0] | R/W | 0010b | GPIO1 configuration. 0d = GPIO1 is disabled 1d = GPIO1 is configured as a general-purpose output (GPO) 2d = GPIO1 is configured as a device interrupt output (IRQ) 3d = GPIO1 is configured as a secondary ASI output (SDOUT2) 4d = GPIO1 is configured as a PDM clock output (PDMCLK) 5d = Reserved 6d = Reserved 7d = GPIO1 is configured as an input to power down all ADC channels 8d = GPIO1 is configured as an input to control when MICBIAS turns on or off (MICBIAS_EN) 9d = GPIO1 is configured as a general-purpose input (GPI) 10d = GPIO1 is configured as a master clock input (MCLK) 11d = GPIO1 is configured as an ASI input for daisy-chain (SDIN) 12d = Reserved 13d = Reserved 14d = GPIO1 is configured as a PDM data input for channel 5 and channel 6 (PDMIN1) 15d = GPIO1 is configured as a PDM data input for channel 7 and channel 8 (PDMIN2) |
| 3 | RESERVED | R | 0b | Reserved bit; Write only reset value |
| 2-0 | GPIO1_DRV[2:0] | R/W | 010b | GPIO1 output drive configuration (not used when GPIO1 is configured as SDOOUT2). 0d = Hi-Z output 1d = Drive active low and active high 2d = Drive active low and weak high 3d = Drive active low and Hi-Z 4d = Drive weak low and active high 5d = Drive Hi-Z and active high 6d to 7d = Reserved |

8.6.1.2.22 GPIO_CFG1 Register (Address = 0x22) [Reset = 0x0]

GPIO_CFG1 is shown in [Figure 8-98](#) and described in [Table 8-74](#).

Return to the [Table 8-52](#).

This register is the GPIO configuration register 1.

Figure 8-98. GPIO_CFG1 Register

| | | | | | | | |
|----------------|---|---|---|----------|----------------|---|---|
| 7 | 6 | 5 | 4 | 3 | 2 | 1 | 0 |
| GPIO2_CFG[3:0] | | | | RESERVED | GPIO2_DRV[2:0] | | |
| R/W-0000b | | | | R-0b | R/W-000b | | |

Table 8-74. GPIO_CFG1 Register Field Descriptions

| Bit | Field | Type | Reset | Description |
|-----|----------------|------|-------|--|
| 7-4 | GPIO2_CFG[3:0] | R/W | 0000b | GPIO2 configuration. 0d = GPIO2 is disabled 1d = GPIO2 is configured as a general-purpose output (GPO) 2d = GPIO2 is configured as a device interrupt output (IRQ) 3d = GPIO2 is configured as a secondary ASI output (SDOUT2) 4d = GPIO2 is configured as a PDM clock output (PDMCLK) 5d = Reserved 6d = Reserved 7d = GPIO2 is configured as an input to power down all ADC channels 8d = GPIO2 is configured as an input to control when MICBIAS turns on or off (MICBIAS_EN) 9d = GPIO2 is configured as a general-purpose input (GPI) 10d = GPIO2 is configured as a master clock input (MCLK) 11d = GPIO2 is configured as an ASI input for daisy-chain (SDIN) 12d = Reserved 13d = Reserved 14d = GPIO2 is configured as a PDM data input for channel 5 and channel 6 (PDMIN1) 15d = GPIO2 is configured as a PDM data input for channel 7 and channel 8 (PDMIN2) |
| 3 | RESERVED | R | 0b | Reserved bit; Write only reset value |
| 2-0 | GPIO2_DRV[2:0] | R/W | 000b | GPIO2 output drive configuration (not used when GPIO2 is configured as SDOUT2). 0d = Hi-Z output 1d = Drive active low and active high 2d = Drive active low and weak high 3d = Drive active low and Hi-Z 4d = Drive weak low and active high 5d = Drive Hi-Z and active high 6d to 7d = Reserved |

8.6.1.2.23 GPIO_CFG2 Register (Address = 0x23) [Reset = 0x0]

GPIO_CFG2 is shown in [Figure 8-99](#) and described in [Table 8-75](#).

Return to the [Table 8-52](#).

This register is the GPIO configuration register 2.

Figure 8-99. GPIO_CFG2 Register

| 7 | 6 | 5 | 4 | 3 | 2 | 1 | 0 |
|----------------|---|---|----------|---|----------------|---|---|
| GPIO3_CFG[3:0] | | | RESERVED | | GPIO3_DRV[2:0] | | |
| R/W-0000b | | | R-0b | | R/W-000b | | |

Table 8-75. GPIO_CFG2 Register Field Descriptions

| Bit | Field | Type | Reset | Description |
|-----|----------------|------|-------|--|
| 7-4 | GPIO3_CFG[3:0] | R/W | 0000b | GPIO3 configuration. 0d = GPIO3 is disabled 1d = GPIO3 is configured as a general-purpose output (GPO) 2d = GPIO3 is configured as a device interrupt output (IRQ) 3d = GPIO3 is configured as a secondary ASI output (SDOUT2) 4d = GPIO3 is configured as a PDM clock output (PDMCLK) 5d = Reserved 6d = Reserved 7d = GPIO3 is configured as an input to power down all ADC channels 8d = GPIO3 is configured as an input to control when MICBIAS turns on or off (MICBIAS_EN) 9d = GPIO3 is configured as a general-purpose input (GPI) 10d = GPIO3 is configured as a master clock input (MCLK) 11d = GPIO3 is configured as an ASI input for daisy-chain (SDIN) 12d = Reserved 13d = Reserved 14d = GPIO3 is configured as a PDM data input for channel 5 and channel 6 (PDMIN1) 15d = GPIO3 is configured as a PDM data input for channel 7 and channel 8 (PDMIN2) |
| 3 | RESERVED | R | 0b | Reserved bit; Write only reset value |
| 2-0 | GPIO3_DRV[2:0] | R/W | 000b | GPIO3 output drive configuration (not used when GPIO3 is configured as SDOUT2). 0d = Hi-Z output 1d = Drive active low and active high 2d = Drive active low and weak high 3d = Drive active low and Hi-Z 4d = Drive weak low and active high 5d = Drive Hi-Z and active high 6d to 7d = Reserved |

8.6.1.2.24 GPI_CFG0 Register (Address = 0x24) [Reset = 0x0]

GPI_CFG0 is shown in [Figure 8-100](#) and described in [Table 8-76](#).

Return to the [Table 8-52](#).

This register is the GPI configuration register 0.

Figure 8-100. GPI_CFG0 Register

| 7 | 6 | 5 | 4 | 3 | 2 | 1 | 0 |
|---------------|---|---|---|----------|---|---|---|
| GPI1_CFG[3:0] | | | | RESERVED | | | |
| R/W-0000b | | | | R-0000b | | | |

Table 8-76. GPI_CFG0 Register Field Descriptions

| Bit | Field | Type | Reset | Description |
|-----|---------------|------|-------|---|
| 7-4 | GPI1_CFG[3:0] | R/W | 0000b | GPI1 configuration. 0d = GPI1 is disabled 1d to 6d = Reserved 7d = GPI1 is configured as an input to power down all ADC channels 8d = GPI1 is configured as an input to control when MICBIAS turns on or off (MICBIAS_EN) 9d = GPI1 is configured as a general-purpose input (GPI) 10d = GPI1 is configured as a master clock input (MCLK) 11d = GPI1 is configured as an ASI input for daisy-chain (SDIN) 12d = Reserved 13d = Reserved 14d = GPI1 is configured as a PDM data input for channel 5 and channel 6 (PDM DIN1) 15d = GPI1 is configured as a PDM data input for channel 7 and channel 8 (PDM DIN2) |
| 3-0 | RESERVED | R | 0000b | Reserved bits; Write only reset value |

8.6.1.2.25 GPI_CFG1 Register (Address = 0x25) [Reset = 0x0]

GPI_CFG1 is shown in [Figure 8-101](#) and described in [Table 8-77](#).

Return to the [Table 8-52](#).

This register is the GPI configuration register 1.

Figure 8-101. GPI_CFG1 Register

| | | | | | | | |
|---------------|---|---|---|----------|---|---|---|
| 7 | 6 | 5 | 4 | 3 | 2 | 1 | 0 |
| GPI2_CFG[3:0] | | | | RESERVED | | | |
| R/W-0000b | | | | R-0000b | | | |

Table 8-77. GPI_CFG1 Register Field Descriptions

| Bit | Field | Type | Reset | Description |
|-----|---------------|------|-------|---|
| 7-4 | GPI2_CFG[3:0] | R/W | 0000b | GPI2 configuration. 0d = GPI2 is disabled 1d to 6d = Reserved 7d = GPI2 is configured as an input to power down all ADC channels 8d = GPI2 is configured as an input to control when MICBIAS turns on or off (MICBIAS_EN) 9d = GPI2 is configured as a general-purpose input (GPI) 10d = GPI2 is configured as a master clock input (MCLK) 11d = GPI2 is configured as an ASI input for daisy-chain (SDIN) 12d = Reserved 13d = Reserved 14d = GPI2 is configured as a PDM data input for channel 5 and channel 6 (PDM DIN1) 15d = GPI2 is configured as a PDM data input for channel 7 and channel 8 (PDM DIN2) |
| 3-0 | RESERVED | R | 0000b | Reserved bits; Write only reset value |

8.6.1.2.26 GPIO_VAL Register (Address = 0x26) [Reset = 0x0]

GPIO_VAL is shown in [Figure 8-102](#) and described in [Table 8-78](#).

Return to the [Table 8-52](#).

This register is the GPIO output value register.

Figure 8-102. GPIO_VAL Register

| | | | | | | | |
|---|---|---|---|---|---|---|---|
| 7 | 6 | 5 | 4 | 3 | 2 | 1 | 0 |
|---|---|---|---|---|---|---|---|

Figure 8-102. GPIO_VAL Register (continued)

| | | | |
|-----------|-----------|-----------|----------|
| GPIO1_VAL | GPIO2_VAL | GPIO3_VAL | RESERVED |
| R/W-0b | R/W-0b | R/W-0b | R-00000b |

Table 8-78. GPIO_VAL Register Field Descriptions

| Bit | Field | Type | Reset | Description |
|-----|-----------|------|--------|--|
| 7 | GPIO1_VAL | R/W | 0b | GPIO1 output value when configured as a GPO. 0d = Drive the output with a value of 0 1d = Drive the output with a value of 1 |
| 6 | GPIO2_VAL | R/W | 0b | GPIO2 output value when configured as a GPO. 0d = Drive the output with a value of 0 1d = Drive the output with a value of 1 |
| 5 | GPIO3_VAL | R/W | 0b | GPIO3 output value when configured as a GPO. 0d = Drive the output with a value of 0 1d = Drive the output with a value of 1 |
| 4-0 | RESERVED | R | 00000b | Reserved bits; Write only reset value |

8.6.1.2.27 GPIO_MON Register (Address = 0x27) [Reset = 0x0]

GPIO_MON is shown in [Figure 8-103](#) and described in [Table 8-79](#).

Return to the [Table 8-52](#).

This register is the GPIO monitor value register.

Figure 8-103. GPIO_MON Register

| | | | | | | | |
|-----------|-----------|-----------|----------|----------|----------|---|---|
| 7 | 6 | 5 | 4 | 3 | 2 | 1 | 0 |
| GPIO1_MON | GPIO2_MON | GPIO3_MON | GPI1_MON | GPI2_MON | RESERVED | | |
| R-0b | R-0b | R-0b | R-0b | R-0b | R-000b | | |

Table 8-79. GPIO_MON Register Field Descriptions

| Bit | Field | Type | Reset | Description |
|-----|-----------|------|-------|---|
| 7 | GPIO1_MON | R | 0b | GPIO1 monitor value when configured as a GPI. 0d = Input monitor value 0 1d = Input monitor value 1 |
| 6 | GPIO2_MON | R | 0b | GPIO2 monitor value when configured as a GPI. 0d = Input monitor value 0 1d = Input monitor value 1 |
| 5 | GPIO3_MON | R | 0b | GPIO3 monitor value when configured as a GPI. 0d = Input monitor value 0 1d = Input monitor value 1 |
| 4 | GPI1_MON | R | 0b | GPI1 monitor value when configured as a GPI. 0d = Input monitor value 0 1d = Input monitor value 1 |
| 3 | GPI2_MON | R | 0b | GPI2 monitor value when configured as a GPI. 0d = Input monitor value 0 1d = Input monitor value 1 |
| 2-0 | RESERVED | R | 000b | Reserved bits; Write only reset value |

8.6.1.2.28 INT_CFG Register (Address = 0x28) [Reset = 0x0]

INT_CFG is shown in [Figure 8-104](#) and described in [Table 8-80](#).

Return to the [Table 8-52](#).

This register is the interrupt configuration register.

Figure 8-104. INT_CFG Register

| 7 | 6 | 5 | 4 | 3 | 2 | 1 | 0 |
|---------|----------------|---|--------------------|---|---------------|-------------------|------------------|
| INT_POL | INT_EVENT[1:0] | | PD_ON_FLT_CFG[1:0] | | LTCH_READ_CFG | PD_ON_FLT_RCV_CFG | LTCH_CLR_ON_READ |
| R/W-0b | R/W-00b | | R/W-00b | | R/W-0b | R/W-0b | R/W-0b |

Table 8-80. INT_CFG Register Field Descriptions

| Bit | Field | Type | Reset | Description |
|-----|--------------------|------|-------|---|
| 7 | INT_POL | R/W | 0b | Interrupt polarity. 0d = Active low (IRQZ) 1d = Active high (IRQ) |
| 6-5 | INT_EVENT[1:0] | R/W | 00b | Interrupt event configuration. 0d = INT asserts on any unmasked latched interrupts event Dont use 2d = INT asserts for 2 ms (typical) for every 4-ms (typical) duration on any unmasked latched interrupts event 3d = INT asserts for 2 ms (typical) one time on each pulse for any unmasked interrupts event |
| 4-3 | PD_ON_FLT_CFG[1:0] | R/W | 00b | Powerdown configuration when fault detected for any channel or MICBIAS fault detected. 0d = Faults event are not used for ADC and MICBIAS power down. It is recommend to set these bits as 2d to shutdown the blocks for which fault occurred. 1d = Only unmasked faults are used for power down of respective ADC channel; In case of MICBIAS fault detected, MICBIAS and all ADC channels gets powered-down based on P0_R58 settings 2d = Both masked or unmasked faults are used for power down of respective ADC channel; In case of MICBIAS fault detected, MICBIAS and all ADC channels gets powered-down based on P0_R58 settings. 3d = Reserved |
| 2 | LTCH_READ_CFG | R/W | 0b | Interrupt latch registers readback configuration. 0d = All interrupts can be read through the LTCH registers 1d = Only unmasked interrupts can be read through the LTCH registers |
| 1 | PD_ON_FLT_RCV_CFG | R/W | 0b | Recovery configuration for ADC channels when fault goes away. 0d = Auto recovery, ADC channels are re-powered up when fault goes away 1d = Manual recovery, ADC channels are required to power-up manually using P0_R119 when fault goes away |
| 0 | LTCH_CLR_ON_READ | R/W | 0b | Configuration for clearing LTCH register bits. 0d = LTCH register bits are cleared on register read only if live status is zero 1d = LTCH register bits are cleared on register read irrespective of live status and set only if live status goes again low to high |

8.6.1.2.29 INT_MASK0 Register (Address = 0x29) [Reset = 0xFF]

INT_MASK0 is shown in [Figure 8-105](#) and described in [Table 8-81](#).

Return to the [Table 8-52](#).

This register is the interrupt masks register 0.

Figure 8-105. INT_MASK0 Register

| 7 | 6 | 5 | 4 | 3 | 2 | 1 | 0 |
|-----------|-----------|-----------|-----------|----------|----------|----------|----------|
| INT_MASK0 | INT_MASK0 | INT_MASK0 | INT_MASK0 | RESERVED | RESERVED | RESERVED | RESERVED |
| R/W-1b | R/W-1b | R/W-1b | R/W-1b | R/W-1b | R/W-1b | R/W-1b | R/W-1b |

Table 8-81. INT_MASK0 Register Field Descriptions

| Bit | Field | Type | Reset | Description |
|-----|-----------|------|-------|---|
| 7 | INT_MASK0 | R/W | 1b | ASI clock error mask. 0d = Unmask 1d = Mask |
| 6 | INT_MASK0 | R/W | 1b | PLL lock interrupt mask. 0d = Unmask 1d = Mask |
| 5 | INT_MASK0 | R/W | 1b | Boost or MICBIAS over temperature interrupt mask. 0d = Unmask 1d = Mask |
| 4 | INT_MASK0 | R/W | 1b | Boost or MICBIAS over current interrupt mask. 0d = Unmask 1d = Mask |
| 3 | RESERVED | R/W | 1b | Reserved bit; Write only reset value |
| 2 | RESERVED | R/W | 1b | Reserved bit; Write only reset value |
| 1 | RESERVED | R/W | 1b | Reserved bit; Write only reset value |
| 0 | RESERVED | R/W | 1b | Reserved bit; Write only reset value |

8.6.1.2.30 INT_MASK1 Register (Address = 0x2A) [Reset = 0x3]

INT_MASK1 is shown in [Figure 8-106](#) and described in [Table 8-82](#).

Return to the [Table 8-52](#).

This register is the interrupt masks register 1.

Figure 8-106. INT_MASK1 Register

| 7 | 6 | 5 | 4 | 3 | 2 | 1 | 0 |
|-----------|-----------|-----------|-----------|----------|----------|----------|----------|
| INT_MASK1 | INT_MASK1 | INT_MASK1 | INT_MASK1 | RESERVED | RESERVED | RESERVED | RESERVED |
| R/W-0b | R/W-0b | R/W-0b | R/W-0b | R/W-0b | R/W-0b | R/W-1b | R/W-1b |

Table 8-82. INT_MASK1 Register Field Descriptions

| Bit | Field | Type | Reset | Description |
|-----|-----------|------|-------|--|
| 7 | INT_MASK1 | R/W | 0b | Channel 1 input DC faults diagnostic interrupt mask. 0d = Unmask 1d = Mask |
| 6 | INT_MASK1 | R/W | 0b | Channel 2 input DC faults diagnostic interrupt mask. 0d = Unmask 1d = Mask |
| 5 | INT_MASK1 | R/W | 0b | Channel 3 input DC faults diagnostic interrupt mask. 0d = Unmask 1d = Mask |
| 4 | INT_MASK1 | R/W | 0b | Channel 4 input DC faults diagnostic interrupt mask. 0d = Unmask 1d = Mask |
| 3 | RESERVED | R/W | 0b | Reserved bit; Write only reset value |
| 2 | RESERVED | R/W | 0b | Reserved bit; Write only reset value |
| 1 | RESERVED | R/W | 1b | Reserved bit; Write only reset value |
| 0 | RESERVED | R/W | 1b | Reserved bit; Write only reset value |

8.6.1.2.31 INT_MASK2 Register (Address = 0x2B) [Reset = 0x0]

INT_MASK2 is shown in [Figure 8-107](#) and described in [Table 8-83](#).

Return to the [Table 8-52](#).

This register is the interrupt masks register 2.

Figure 8-107. INT_MASK2 Register

| 7 | 6 | 5 | 4 | 3 | 2 | 1 | 0 |
|-----------|-----------|-----------|-----------|-----------|-----------|-----------|-----------|
| INT_MASK2 | INT_MASK2 | INT_MASK2 | INT_MASK2 | INT_MASK2 | INT_MASK2 | INT_MASK2 | INT_MASK2 |
| R/W-0b | R/W-0b | R/W-0b | R/W-0b | R/W-0b | R/W-0b | R/W-0b | R/W-0b |

Table 8-83. INT_MASK2 Register Field Descriptions

| Bit | Field | Type | Reset | Description |
|-----|-----------|------|-------|--|
| 7 | INT_MASK2 | R/W | 0b | Input diagnostics; Open inputs fault interrupt mask. 0d = Unmask 1d = Mask |
| 6 | INT_MASK2 | R/W | 0b | Input diagnostics; Inputs shorted fault interrupt mask. 0d = Unmask 1d = Mask |
| 5 | INT_MASK2 | R/W | 0b | Input diagnostics; INxP shorted to ground fault interrupt mask. 0d = Unmask 1d = Mask |
| 4 | INT_MASK2 | R/W | 0b | Input diagnostics; INxM shorted to ground fault interrupt mask. 0d = Unmask 1d = Mask |
| 3 | INT_MASK2 | R/W | 0b | Input diagnostics; INxP shorted to MICBIAS fault interrupt mask. 0d = Unmask 1d = Mask |
| 2 | INT_MASK2 | R/W | 0b | Input diagnostics; INxM shorted to MICBIAS fault interrupt mask. 0d = Unmask 1d = Mask |
| 1 | INT_MASK2 | R/W | 0b | Input diagnostics; INxP shorted to VBAT_IN fault interrupt mask. 0d = Unmask 1d = Mask |
| 0 | INT_MASK2 | R/W | 0b | Input diagnostics; INxM shorted to VBAT_IN fault interrupt mask. 0d = Unmask 1d = Mask |

8.6.1.2.32 INT_LTCH0 Register (Address = 0x2C) [Reset = 0x0]

INT_LTCH0 is shown in [Figure 8-108](#) and described in [Table 8-84](#).

Return to the [Table 8-52](#).

This register is the latched Interrupt readback register 0.

Figure 8-108. INT_LTCH0 Register

| 7 | 6 | 5 | 4 | 3 | 2 | 1 | 0 |
|-----------|-----------|-----------|-----------|----------|----------|----------|----------|
| INT_LTCH0 | INT_LTCH0 | INT_LTCH0 | INT_LTCH0 | RESERVED | RESERVED | RESERVED | RESERVED |
| R-0b | R-0b | R-0b | R-0b | R-0b | R-0b | R-0b | R-0b |

Table 8-84. INT_LTCH0 Register Field Descriptions

| Bit | Field | Type | Reset | Description |
|-----|-----------|------|-------|---|
| 7 | INT_LTCH0 | R | 0b | Fault status for an ASI bus clock error (self-clearing bit). 0d = No fault detected 1d = Fault detected |
| 6 | INT_LTCH0 | R | 0b | Status of PLL lock (self-clearing bit). 0d = No PLL lock detected 1d = PLL lock detected |

Table 8-84. INT_LTCH0 Register Field Descriptions (continued)

| Bit | Field | Type | Reset | Description |
|-----|-----------|------|-------|--|
| 5 | INT_LTCH0 | R | 0b | Fault status for boost or MICBIAS over temperature (self-clearing bit). 0d = No fault detected 1d = Fault detected |
| 4 | INT_LTCH0 | R | 0b | Fault status for boost or MICBIAS over current (self-clearing bit). 0d = No fault detected 1d = Fault detected |
| 3 | RESERVED | R | 0b | Reserved bit; Write only reset value |
| 2 | RESERVED | R | 0b | Reserved bit; Write only reset value |
| 1 | RESERVED | R | 0b | Reserved bit; Write only reset value |
| 0 | RESERVED | R | 0b | Reserved bit; Write only reset value |

8.6.1.2.33 CHx_LTCH Register (Address = 0x2D) [Reset = 0x0]

CHx_LTCH is shown in [Figure 8-109](#) and described in [Table 8-85](#).

Return to the [Table 8-52](#).

This register is the latched Interrupt status register for channel level diagnostic summary.

Figure 8-109. CHx_LTCH Register

| 7 | 6 | 5 | 4 | 3 | 2 | 1 | 0 |
|------------------|------------------|------------------|------------------|----------|----------|------------------|----------|
| STS_CHx_LTC H | STS_CHx_LTC H | STS_CHx_LTC H | STS_CHx_LTC H | RESERVED | RESERVED | STS_CHx_LTC H | RESERVED |
| R-0b | R-0b | R-0b | R-0b | R-0b | R-0b | R-0b | R-0b |

Table 8-85. CHx_LTCH Register Field Descriptions

| Bit | Field | Type | Reset | Description |
|-----|--------------|------|-------|--|
| 7 | STS_CHx_LTCH | R | 0b | Status of CH1_LTCH (self-clearing bit). 0d = No faults occurred in channel 1 1d = Atleast a fault has occurred in channel 1 |
| 6 | STS_CHx_LTCH | R | 0b | Status of CH2_LTCH (self-clearing bit). 0d = No faults occurred in channel 2 1d = Atleast a fault has occurred in channel 2 |
| 5 | STS_CHx_LTCH | R | 0b | Status of CH3_LTCH (self-clearing bit). 0d = No faults occurred in channel 3 1d = Atleast a fault has occurred in channel 3 |
| 4 | STS_CHx_LTCH | R | 0b | Status of CH4_LTCH (self-clearing bit). 0d = No faults occurred in channel 4 1d = Atleast a fault has occurred in channel 4 |
| 3 | RESERVED | R | 0b | Reserved bit; Write only reset value |
| 2 | RESERVED | R | 0b | Reserved bit; Write only reset value |
| 1 | STS_CHx_LTCH | R | 0b | Status of short to VBAT_IN fault detected when VBAT_IN is less than MICBIAS (self-clearing bit). 0d = Short to VBAT_IN fault when VBAT_IN is less than MICBIAS has not occurred in any channel 1d = Short to VBAT_IN fault when VBAT_IN is less than MICBIAS has occurred in atleast one channel |
| 0 | RESERVED | R | 0b | Reserved bit; Write only reset value |

8.6.1.2.34 CH1_LTCH Register (Address = 0x2E) [Reset = 0x0]

CH1_LTCH is shown in [Figure 8-110](#) and described in [Table 8-86](#).

Return to the [Table 8-52](#).

This register is the latched Interrupt status register for channel 1 fault diagnostic

Figure 8-110. CH1_LTCH Register

| 7 | 6 | 5 | 4 | 3 | 2 | 1 | 0 |
|----------|----------|----------|----------|----------|----------|----------|----------|
| CH1_LTCH | CH1_LTCH | CH1_LTCH | CH1_LTCH | CH1_LTCH | CH1_LTCH | CH1_LTCH | CH1_LTCH |
| R-0b | R-0b | R-0b | R-0b | R-0b | R-0b | R-0b | R-0b |

Table 8-86. CH1_LTCH Register Field Descriptions

| Bit | Field | Type | Reset | Description |
|-----|----------|------|-------|--|
| 7 | CH1_LTCH | R | 0b | Channel 1 open input fault status (self-clearing bit). 0d = No open input detected 1d = Open input detected |
| 6 | CH1_LTCH | R | 0b | Channel 1 input pair short fault status (self-clearing bit). 0d = No input pair short detected 1d = Input short to each other detected |
| 5 | CH1_LTCH | R | 0b | Channel 1 IN1P short to ground fault status (self-clearing bit). 0d = IN1P no short to ground detected 1d = IN1P short to ground detected |
| 4 | CH1_LTCH | R | 0b | Channel 1 IN1M short to ground fault status (self-clearing bit). 0d = IN1M no short to ground detected 1d = IN1M short to ground detected |
| 3 | CH1_LTCH | R | 0b | Channel 1 IN1P short to MICBIAS fault status (self-clearing bit). 0d = IN1P no short to MICBIAS detected 1d = IN1P short to MICBIAS detected |
| 2 | CH1_LTCH | R | 0b | Channel 1 IN1M short to MICBIAS fault status (self-clearing bit). 0d = IN1M no short to MICBIAS detected 1d = IN1M short to MICBIAS detected |
| 1 | CH1_LTCH | R | 0b | Channel 1 IN1P short to VBAT_IN fault status (self-clearing bit). 0d = IN1P no short to VBAT_IN detected 1d = IN1P short to VBAT_IN detected |
| 0 | CH1_LTCH | R | 0b | Channel 1 IN1M short to VBAT_IN fault status (self-clearing bit - This bit gets clear on reading Page-0, Register-54d, INT_LTCH2 register). 0d = IN1M no short to VBAT_IN detected 1d = IN1M short to VBAT_IN detected |

8.6.1.2.35 CH2_LTCH Register (Address = 0x2F) [Reset = 0x0]

CH2_LTCH is shown in [Figure 8-111](#) and described in [Table 8-87](#).

Return to the [Table 8-52](#).

This register is the latched Interrupt status register for channel 2 fault diagnostic.

Figure 8-111. CH2_LTCH Register

| 7 | 6 | 5 | 4 | 3 | 2 | 1 | 0 |
|----------|----------|----------|----------|----------|----------|----------|----------|
| CH2_LTCH | CH2_LTCH | CH2_LTCH | CH2_LTCH | CH2_LTCH | CH2_LTCH | CH2_LTCH | CH2_LTCH |
| R-0b | R-0b | R-0b | R-0b | R-0b | R-0b | R-0b | R-0b |

Table 8-87. CH2_LTCH Register Field Descriptions

| Bit | Field | Type | Reset | Description |
|-----|----------|------|-------|--|
| 7 | CH2_LTCH | R | 0b | Channel 2 open input fault status (self-clearing bit). 0d = No open input detected 1d = Open input detected |
| 6 | CH2_LTCH | R | 0b | Channel 2 input pair short fault status (self-clearing bit). 0d = No input pair short detected 1d = Input short to each other detected |

Table 8-87. CH2_LTCH Register Field Descriptions (continued)

| Bit | Field | Type | Reset | Description |
|-----|----------|------|-------|--|
| 5 | CH2_LTCH | R | 0b | Channel 2 IN2P short to ground fault status (self-clearing bit). 0d = IN2P no short to ground detected 1d = IN2P short to ground detected |
| 4 | CH2_LTCH | R | 0b | Channel 2 IN2M short to ground fault status (self-clearing bit). 0d = IN2M no short to ground detected 1d = IN2M short to ground detected |
| 3 | CH2_LTCH | R | 0b | Channel 2 IN2P short to MICBIAS fault status (self-clearing bit). 0d = IN2P no short to MICBIAS detected 1d = IN2P short to MICBIAS detected |
| 2 | CH2_LTCH | R | 0b | Channel 2 IN2M short to MICBIAS fault status (self-clearing bit). 0d = IN2M no short to MICBIAS detected 1d = IN2M short to MICBIAS detected |
| 1 | CH2_LTCH | R | 0b | Channel 2 IN2P short to VBAT_IN fault status (self-clearing bit). 0d = IN2P no short to VBAT_IN detected 1d = IN2P short to VBAT_IN detected |
| 0 | CH2_LTCH | R | 0b | Channel 2 IN2M short to VBAT_IN fault status (self-clearing bit - This bit gets clear on reading Page-0, Register-54d, INT_LTCH2 register). 0d = IN2M no short to VBAT_IN detected 1d = IN2M short to VBAT_IN detected |

8.6.1.2.36 CH3_LTCH Register (Address = 0x30) [Reset = 0x0]

CH3_LTCH is shown in [Figure 8-112](#) and described in [Table 8-88](#).

Return to the [Table 8-52](#).

This register is the latched Interrupt status register for channel3 fault diagnostic

Figure 8-112. CH3_LTCH Register

| 7 | 6 | 5 | 4 | 3 | 2 | 1 | 0 |
|----------|----------|----------|----------|----------|----------|----------|----------|
| CH3_LTCH | CH3_LTCH | CH3_LTCH | CH3_LTCH | CH3_LTCH | CH3_LTCH | CH3_LTCH | CH3_LTCH |
| R-0b | R-0b | R-0b | R-0b | R-0b | R-0b | R-0b | R-0b |

Table 8-88. CH3_LTCH Register Field Descriptions

| Bit | Field | Type | Reset | Description |
|-----|----------|------|-------|--|
| 7 | CH3_LTCH | R | 0b | Channel 3 open input fault status (self-clearing bit). 0d = No open input detected 1d = Open input detected |
| 6 | CH3_LTCH | R | 0b | Channel 3 input pair short fault status (self-clearing bit). 0d = No input pair short detected 1d = Input short to each other detected |
| 5 | CH3_LTCH | R | 0b | Channel 3 IN3P short to ground fault status (self-clearing bit). 0d = IN3P no short to ground detected 1d = IN3P short to ground detected |
| 4 | CH3_LTCH | R | 0b | Channel 3 IN3M short to ground fault status (self-clearing bit). 0d = IN3M no short to ground detected 1d = IN3M short to ground detected |
| 3 | CH3_LTCH | R | 0b | Channel 3 IN3P short to MICBIAS fault status (self-clearing bit). 0d = IN3P no short to MICBIAS detected 1d = IN3P short to MICBIAS detected |
| 2 | CH3_LTCH | R | 0b | Channel 3 IN3M short to MICBIAS fault status (self-clearing bit). 0d = IN3M no short to MICBIAS detected 1d = IN3M short to MICBIAS detected |
| 1 | CH3_LTCH | R | 0b | Channel 3 IN3P short to VBAT_IN fault status (self-clearing bit). 0d = IN3P no short to VBAT_IN detected 1d = IN3P short to VBAT_IN detected |

Table 8-88. CH3_LTCH Register Field Descriptions (continued)

| Bit | Field | Type | Reset | Description |
|-----|----------|------|-------|--|
| 0 | CH3_LTCH | R | 0b | Channel 3 IN3M short to VBAT_IN fault status (self-clearing bit - This bit gets clear on reading Page-0, Register-54d, INT_LTCH2 register). 0d = IN3M no short to VBAT_IN detected 1d = IN3M short to VBAT_IN detected |

8.6.1.2.37 CH4_LTCH Register (Address = 0x31) [Reset = 0x0]

CH4_LTCH is shown in [Figure 8-113](#) and described in [Table 8-89](#).

Return to the [Table 8-52](#).

This register is the latched Interrupt status register for channel 4 fault diagnostic.

Figure 8-113. CH4_LTCH Register

| 7 | 6 | 5 | 4 | 3 | 2 | 1 | 0 |
|----------|----------|----------|----------|----------|----------|----------|----------|
| CH4_LTCH | CH4_LTCH | CH4_LTCH | CH4_LTCH | CH4_LTCH | CH4_LTCH | CH4_LTCH | CH4_LTCH |
| R-0b | R-0b | R-0b | R-0b | R-0b | R-0b | R-0b | R-0b |

Table 8-89. CH4_LTCH Register Field Descriptions

| Bit | Field | Type | Reset | Description |
|-----|----------|------|-------|--|
| 7 | CH4_LTCH | R | 0b | Channel 4 open input fault status (self-clearing bit). 0d = No open input detected 1d = Open input detected |
| 6 | CH4_LTCH | R | 0b | Channel 4 input pair short fault status (self-clearing bit). 0d = No input pair short detected 1d = Input short to each other detected |
| 5 | CH4_LTCH | R | 0b | Channel 4 IN4P short to ground fault status (self-clearing bit). 0d = IN4P no short to ground detected 1d = IN4P short to ground detected |
| 4 | CH4_LTCH | R | 0b | Channel 4 IN4M short to ground fault status (self-clearing bit). 0d = IN4M no short to ground detected 1d = IN4M short to ground detected |
| 3 | CH4_LTCH | R | 0b | Channel 4 IN4P short to MICBIAS fault status (self-clearing bit). 0d = IN4P no short to MICBIAS detected 1d = IN4P short to MICBIAS detected |
| 2 | CH4_LTCH | R | 0b | Channel 4 IN4M short to MICBIAS fault status (self-clearing bit). 0d = IN4M no short to MICBIAS detected 1d = IN4M short to MICBIAS detected |
| 1 | CH4_LTCH | R | 0b | Channel 4 IN4P short to VBAT_IN fault status (self-clearing bit). 0d = IN4P no short to VBAT_IN detected 1d = IN4P short to VBAT_IN detected |
| 0 | CH4_LTCH | R | 0b | Channel 4 IN4M short to VBAT_IN fault status (self-clearing bit - This bit gets clear on reading Page-0, Register-54d, INT_LTCH2 register). 0d = IN4M no short to VBAT_IN detected 1d = IN4M short to VBAT_IN detected |

8.6.1.2.38 INT_MASK3 Register (Address = 0x34) [Reset = 0x0]

INT_MASK3 is shown in [Figure 8-114](#) and described in [Table 8-90](#).

Return to the [Table 8-52](#).

This register is the interrupt masks register 3.

Figure 8-114. INT_MASK3 Register

| 7 | 6 | 5 | 4 | 3 | 2 | 1 | 0 |
|---|---|---|---|---|---|---|---|
|---|---|---|---|---|---|---|---|

Figure 8-114. INT_MASK3 Register (continued)

| | | | | | |
|-----------|-----------|-----------|-----------|-----------|----------|
| INT_MASK3 | INT_MASK3 | INT_MASK3 | INT_MASK3 | INT_MASK3 | RESERVED |
| R/W-0b | R/W-0b | R/W-0b | R/W-0b | R/W-0b | R-000b |

Table 8-90. INT_MASK3 Register Field Descriptions

| Bit | Field | Type | Reset | Description |
|-----|-----------|------|-------|--|
| 7 | INT_MASK3 | R/W | 0b | INxP over voltage fault mask. 0d = Unmask 1d = Mask |
| 6 | INT_MASK3 | R/W | 0b | INxM over voltage fault mask. 0d = Unmask 1d = Mask |
| 5 | INT_MASK3 | R/W | 0b | MICBIAS high current fault mask. 0d = Unmask 1d = Mask |
| 4 | INT_MASK3 | R/W | 0b | MICBIAS low current fault mask. 0d = Unmask 1d = Mask |
| 3 | INT_MASK3 | R/W | 0b | MICBIAS over voltage fault mask. 0d = Unmask 1d = Mask |
| 2-0 | RESERVED | R | 000b | Reserved bits; Write only reset value |

8.6.1.2.39 INT_LTCH1 Register (Address = 0x35) [Reset = 0x0]

INT_LTCH1 is shown in [Figure 8-115](#) and described in [Table 8-91](#).

Return to the [Table 8-52](#).

This register is the latched Interrupt readback register 1.

Figure 8-115. INT_LTCH1 Register

| | | | | | | | |
|-----------|-----------|-----------|-----------|----------|----------|----------|----------|
| 7 | 6 | 5 | 4 | 3 | 2 | 1 | 0 |
| INT_LTCH1 | INT_LTCH1 | INT_LTCH1 | INT_LTCH1 | RESERVED | RESERVED | RESERVED | RESERVED |
| R-0b | R-0b | R-0b | R-0b | R-0b | R-0b | R-0b | R-00b |

Table 8-91. INT_LTCH1 Register Field Descriptions

| Bit | Field | Type | Reset | Description |
|-----|-----------|------|-------|---|
| 7 | INT_LTCH1 | R | 0b | Channel 1 IN1P over voltage fault status (self-clearing bit - This bit gets clear on reading Page-0, Register-46d, CH1_LTCH register). 0d = No IN1P over voltage fault detected 1d = IN1P over voltage fault has detected |
| 6 | INT_LTCH1 | R | 0b | Channel 2 IN2P over voltage fault status (self-clearing bit - This bit gets clear on reading Page-0, Register-47d, CH2_LTCH register). 0d = No IN2P over voltage fault detected 1d = IN2P over voltage fault has detected |
| 5 | INT_LTCH1 | R | 0b | Channel 3 IN3P over voltage fault status (self-clearing bit - This bit gets clear on reading Page-0, Register-48d, CH3_LTCH register). 0d = No IN3P over voltage fault detected 1d = IN3P over voltage fault has detected |
| 4 | INT_LTCH1 | R | 0b | Channel 4 IN4P over voltage fault status (self-clearing bit - This bit gets clear on reading Page-0, Register-49d, CH4_LTCH register). 0d = No IN4P over voltage fault detected 1d = IN4P over voltage fault has detected |
| 3 | RESERVED | R | 0b | Reserved bit; Write only reset value |
| 2 | RESERVED | R | 0b | Reserved bit; Write only reset value |

Table 8-91. INT_LTCH1 Register Field Descriptions (continued)

| Bit | Field | Type | Reset | Description |
|-----|----------|------|-------|---------------------------------------|
| 1-0 | RESERVED | R | 00b | Reserved bits; Write only reset value |

8.6.1.2.40 INT_LTCH2 Register (Address = 0x36) [Reset = 0x0]

INT_LTCH2 is shown in [Figure 8-116](#) and described in [Table 8-92](#).

Return to the [Table 8-52](#).

This register is the latched Interrupt readback register 2.

Figure 8-116. INT_LTCH2 Register

| 7 | 6 | 5 | 4 | 3 | 2 | 1 | 0 |
|-----------|-----------|-----------|-----------|----------|----------|----------|---|
| INT_LTCH2 | INT_LTCH2 | INT_LTCH2 | INT_LTCH2 | RESERVED | RESERVED | RESERVED | |
| R-0b | R-0b | R-0b | R-0b | R-0b | R-0b | R-00b | |

Table 8-92. INT_LTCH2 Register Field Descriptions

| Bit | Field | Type | Reset | Description |
|-----|-----------|------|-------|---|
| 7 | INT_LTCH2 | R | 0b | Channel 1 IN1M over voltage fault status (self-clearing bit - This bit gets clear on reading Page-0, Register-46d, CH1_LTCH register). 0d = No IN1M over voltage fault detected 1d = IN1M over voltage fault has detected |
| 6 | INT_LTCH2 | R | 0b | Channel 2 IN2M over voltage fault status (self-clearing bit - This bit gets clear on reading Page-0, Register-47d, CH2_LTCH register). 0d = No IN2M over voltage fault detected 1d = IN2M over voltage fault has detected |
| 5 | INT_LTCH2 | R | 0b | Channel 3 IN3M over voltage fault status (self-clearing bit - This bit gets clear on reading Page-0, Register-48d, CH3_LTCH register). 0d = No IN3M over voltage fault detected 1d = IN3M over voltage fault has detected |
| 4 | INT_LTCH2 | R | 0b | Channel 4 IN4M over voltage fault status (self-clearing bit - This bit gets clear on reading Page-0, Register-49d, CH4_LTCH register). 0d = No IN4M over voltage fault detected 1d = IN4M over voltage fault has detected |
| 3 | RESERVED | R | 0b | Reserved bit; Write only reset value |
| 2 | RESERVED | R | 0b | Reserved bit; Write only reset value |
| 1-0 | RESERVED | R | 00b | Reserved bits; Write only reset value |

8.6.1.2.41 INT_LTCH3 Register (Address = 0x37) [Reset = 0x0]

INT_LTCH3 is shown in [Figure 8-117](#) and described in [Table 8-93](#).

Return to the [Table 8-52](#).

This register is the latched Interrupt readback register 3.

Figure 8-117. INT_LTCH3 Register

| 7 | 6 | 5 | 4 | 3 | 2 | 1 | 0 |
|-----------|-----------|-----------|----------|---|---|---|---|
| INT_LTCH3 | INT_LTCH3 | INT_LTCH3 | RESERVED | | | | |
| R-0b | R-0b | R-0b | R-00000b | | | | |

Table 8-93. INT_LTCH3 Register Field Descriptions

| Bit | Field | Type | Reset | Description |
|-----|-----------|------|-------|---|
| 7 | INT_LTCH3 | R | 0b | Fault status for MICBIAS high current (self-clearing bit). 0d = No fault detected 1d = Fault detected |

Table 8-93. INT_LTCH3 Register Field Descriptions (continued)

| Bit | Field | Type | Reset | Description |
|-----|-----------|------|--------|---|
| 6 | INT_LTCH3 | R | 0b | Fault status for MICBIAS low current (self-clearing bit) 0d = No fault detected 1d = Fault detected |
| 5 | INT_LTCH3 | R | 0b | Fault status for MICBIAS over voltage (self-clearing bit). 0d = No fault detected 1d = Fault detected |
| 4-0 | RESERVED | R | 00000b | Reserved bits; Write only reset value |

8.6.1.2.42 MBDIAG_CFG0 Register (Address = 0x38) [Reset = 0xBA]

MBDIAG_CFG0 is shown in [Figure 8-118](#) and described in [Table 8-94](#).

Return to the [Table 8-52](#).

This register is the MICBIAS diagnostic configuration register 0.

Figure 8-118. MBDIAG_CFG0 Register

| 7 | 6 | 5 | 4 | 3 | 2 | 1 | 0 |
|---------------------------|---|---|---|---|---|---|---|
| MBIAS_HIGH_CURR_THRS[7:0] | | | | | | | |
| R/W-10111010b | | | | | | | |

Table 8-94. MBDIAG_CFG0 Register Field Descriptions

| Bit | Field | Type | Reset | Description |
|-----|---------------------------|------|-----------|---|
| 7-0 | MBIAS_HIGH_CURR_THRS[7:0] | R/W | 10111010b | Threshold for MICBIAS high load current fault diagnostic. 0d to 56d = Reserved 57d = High load current threshold is set as 0 mA (typ) 58d = High load current threshold is set as 0.54 mA (typ) 59d = High load current threshold is set as 1.08 mA (typ) 60d to 185d = High load current threshold is set as per configuration 186d = High load current threshold is set as 69.66 mA (typ) 187d to 241d = High load current threshold is set as per configuration 242d = High load current threshold is set as 99.90 mA (typ) 243d to 255d = Reserved |

8.6.1.2.43 MBDIAG_CFG1 Register (Address = 0x39) [Reset = 0x4B]

MBDIAG_CFG1 is shown in [Figure 8-119](#) and described in [Table 8-95](#).

Return to the [Table 8-52](#).

This register is the MICBIAS diagnostic configuration register 1.

Figure 8-119. MBDIAG_CFG1 Register

| 7 | 6 | 5 | 4 | 3 | 2 | 1 | 0 |
|--------------------------|---|---|---|---|---|---|---|
| MBIAS_LOW_CURR_THRS[7:0] | | | | | | | |
| R/W-01001011b | | | | | | | |

Table 8-95. MBDIAG_CFG1 Register Field Descriptions

| Bit | Field | Type | Reset | Description |
|-----|--------------------------|------|-----------|---|
| 7-0 | MBIAS_LOW_CURR_THRS[7:0] | R/W | 01001011b | Threshold for MICBIAS low load current fault diagnostic. 0d to 56d = Reserved 57d = Low load current threshold is set as 0 mA (typ) 58d = Low load current threshold is set as 0.54 mA (typ) 59d = Low load current threshold is set as 1.08 mA (typ) 60d to 74d = Low load current threshold is set as per configuration 75d = Low load current threshold is set as 9.72 mA (typ) 76d to 241d = Low load current threshold is set as per configuration 242d = Low load current threshold is set as 99.90 mA (typ) 243d to 255d = Reserved |

8.6.1.2.44 MBDIAG_CFG2 Register (Address = 0x3A) [Reset = 0x10]

MBDIAG_CFG2 is shown in [Figure 8-120](#) and described in [Table 8-96](#).

Return to the [Table 8-52](#).

This register is the MICBIAS diagnostic configuration register 2.

Figure 8-120. MBDIAG_CFG2 Register

| 7 | 6 | 5 | 4 | 3 | 2 | 1 | 0 |
|-----------------|-----------------|-----------------|-----------------|----------|----------|---|---|
| PD_MBIAS_FAULT1 | PD_MBIAS_FAULT2 | PD_MBIAS_FAULT3 | PD_MBIAS_FAULT4 | RESERVED | RESERVED | | |
| R/W-0b | R/W-0b | R/W-0b | R/W-1b | R/W-0b | R-000b | | |

Table 8-96. MBDIAG_CFG2 Register Field Descriptions

| Bit | Field | Type | Reset | Description |
|-----|-----------------|------|-------|---|
| 7 | PD_MBIAS_FAULT1 | R/W | 0b | Powerdown configuration of MICBIAS fault 1 0d = No powerdown when MICBIAS fault detected 1d = MICBIAS and all ADC channels gets powerdown when low current fault occurs and P0_R40, PD_ON_FLT_CFG = 1d 1d = MICBIAS and all ADC channels gets powerdown when high current fault occurs and P0_R40, PD_ON_FLT_CFG = 2d |
| 6 | PD_MBIAS_FAULT2 | R/W | 0b | Powerdown configuration of MICBIAS fault 2 0d = No powerdown when MICBIAS fault detected 1d = MICBIAS and all ADC channels gets powerdown when over voltage fault occurs and P0_R40, PD_ON_FLT_CFG = 1d 1d = MICBIAS and all ADC channels gets powerdown when low current fault occurs and P0_R40, PD_ON_FLT_CFG = 2d |
| 5 | PD_MBIAS_FAULT3 | R/W | 0b | Powerdown configuration of MICBIAS fault 3 0d = No powerdown when MICBIAS fault detected 1d = MICBIAS and all ADC channels gets powerdown when over temperature fault occurs and P0_R40, PD_ON_FLT_CFG = 1d 1d = MICBIAS and all ADC channels gets powerdown when over voltage fault occurs and P0_R40, PD_ON_FLT_CFG = 2d |
| 4 | PD_MBIAS_FAULT4 | R/W | 1b | Powerdown configuration of MICBIAS fault 4 0d = No powerdown when MICBIAS fault detected 1d = MICBIAS and all ADC channels gets powerdown when high current fault occurs and P0_R40, PD_ON_FLT_CFG = 1d 1d = MICBIAS and all ADC channels gets powerdown when over temperature fault occurs and P0_R40, PD_ON_FLT_CFG = 2d. It is recommended to use this setting to protect chip from over temperature fault. |
| 3 | RESERVED | R/W | 0b | Reserved bit; Write only reset value |
| 2-0 | RESERVED | R | 000b | Reserved bits; Write only reset value |

8.6.1.2.45 BIAS_CFG Register (Address = 0x3B) [Reset = 0xD0]

BIAS_CFG is shown in [Figure 8-121](#) and described in [Table 8-97](#).

Return to the [Table 8-52](#).

This register is the MICBIAS configuration register.

Figure 8-121. BIAS_CFG Register

| 7 | 6 | 5 | 4 | 3 | 2 | 1 | 0 |
|----------------|---|---|----------|---|----------|---|---|
| MBIAS_VAL[3:0] | | | RESERVED | | RESERVED | | |
| R/W-1101b | | | R-00b | | R/W-00b | | |

Table 8-97. BIAS_CFG Register Field Descriptions

| Bit | Field | Type | Reset | Description |
|-----|----------------|------|-------|--|
| 7-4 | MBIAS_VAL[3:0] | R/W | 1101b | MICBIAS value. Dont use Dont use Dont use Dont use Dont use Dont use Dont use 7d = Microphone bias is set to 5 V 8d = Microphone bias is set to 5.5 V 9d = Microphone bias is set to 6 V 10d = Microphone bias is set to 6.5 V 11d = Microphone bias is set to 7 V 12d = Microphone bias is set to 7.5 V 13d = Microphone bias is set to 8 V 14d = Microphone bias is set to 8.5 V 15d = Microphone bias is set to 9 V |
| 3-2 | RESERVED | R | 00b | Reserved bits; Write only reset value |
| 1-0 | RESERVED | R/W | 00b | Reserved bits; Write only reset values |

8.6.1.2.46 CH1_CFG0 Register (Address = 0x3C) [Reset = 0x10]

CH1_CFG0 is shown in [Figure 8-122](#) and described in [Table 8-98](#).

Return to the [Table 8-52](#).

This register is configuration register 0 for channel 1.

Figure 8-122. CH1_CFG0 Register

| 7 | 6 | 5 | 4 | 3 | 2 | 1 | 0 |
|-----------|----------------|---|--------|----------------------|------------------|---|-----------|
| CH1_INTYP | CH1_INSRC[1:0] | | CH1_DC | CH1_MIC_IN_R ANGE | CH1_PGA_CFG[1:0] | | CH1_AGCEN |
| R/W-0b | R/W-00b | | R/W-1b | R/W-0b | R/W-00b | | R/W-0b |

Table 8-98. CH1_CFG0 Register Field Descriptions

| Bit | Field | Type | Reset | Description |
|-----|----------------|------|-------|--|
| 7 | CH1_INTYP | R/W | 0b | Channel 1 input type. 0d = Microphone input 1d = Line input |
| 6-5 | CH1_INSRC[1:0] | R/W | 00b | Channel 1 input configuration. 0d = Analog differential input 1d = Analog single-ended input 2d = Reserved 3d = Reserved |

Table 8-98. CH1_CFG0 Register Field Descriptions (continued)

| Bit | Field | Type | Reset | Description |
|-----|------------------|------|-------|--|
| 4 | CH1_DC | R/W | 1b | Channel 1 input coupling. 0d = AC-coupled input 1d = DC-coupled input |
| 3 | CH1_MIC_IN_RANGE | R/W | 0b | Channel 1 microphone input range. 0d = Low swing mode; Differential input AC signal full-scale of 2-VRMS supported provided DC differential common mode voltage IN1P - IN1M < 4.2 V. Single-ended AC signal 1-VRMS supported provided DC common mode voltage is < 2.1 V. 1d = High swing mode; Differential Input IN1P-IN1M peak voltage up to 14.14 V or single ended 7.07 V supported. User required to adjust the channel gain and digital volume control based on the max signal level used in system. |
| 2-1 | CH1_PGA_CFG[1:0] | R/W | 00b | Channel 1 CMRR Configuration. 0d = High SNR performance mode Dont use 2d = High CMRR performance mode 3d = Reserved |
| 0 | CH1_AGCEN | R/W | 0b | Channel 1 automatic gain controller (AGC) setting. 0d = AGC disabled 1d = AGC enabled based on the configuration of bit 3 in register 108 (P0_R108); This must be used only with AC-coupled input |

8.6.1.2.47 CH1_CFG1 Register (Address = 0x3D) [Reset = 0x0]

CH1_CFG1 is shown in [Figure 8-123](#) and described in [Table 8-99](#).

Return to the [Table 8-52](#).

This register is configuration register 1 for channel 1.

Figure 8-123. CH1_CFG1 Register

| 7 | 6 | 5 | 4 | 3 | 2 | 1 | 0 |
|---------------|---|---|---|---|---|----------|----------|
| CH1_GAIN[5:0] | | | | | | RESERVED | RESERVED |
| R/W-000000b | | | | | | R/W-0b | R-0b |

Table 8-99. CH1_CFG1 Register Field Descriptions

| Bit | Field | Type | Reset | Description |
|-----|---------------|------|---------|--|
| 7-2 | CH1_GAIN[5:0] | R/W | 000000b | Channel 1 gain. 0d = Channel gain is set to 0 dB 1d = Channel gain is set to 1 dB 2d = Channel gain is set to 2 dB 3d to 41d = Channel gain is set as per configuration 42d = Channel gain is set to 42 dB 43d to 63d = Reserved |
| 1 | RESERVED | R/W | 0b | Reserved bit; Write only reset value |
| 0 | RESERVED | R | 0b | Reserved bit; Write only reset value |

8.6.1.2.48 CH1_CFG2 Register (Address = 0x3E) [Reset = 0xC9]

CH1_CFG2 is shown in [Figure 8-124](#) and described in [Table 8-100](#).

Return to the [Table 8-52](#).

This register is configuration register 2 for channel 1.

Figure 8-124. CH1_CFG2 Register

| 7 | 6 | 5 | 4 | 3 | 2 | 1 | 0 |
|---|---|---|---|---|---|---|---|
|---|---|---|---|---|---|---|---|

Figure 8-124. CH1_CFG2 Register (continued)

| |
|---------------|
| CH1_DVOL[7:0] |
| R/W-11001001b |

Table 8-100. CH1_CFG2 Register Field Descriptions

| Bit | Field | Type | Reset | Description |
|-----|---------------|------|-----------|--|
| 7-0 | CH1_DVOL[7:0] | R/W | 11001001b | Channel 1 digital volume control. 0d = Digital volume is muted 1d = Digital volume control is set to -100 dB 2d = Digital volume control is set to -99.5 dB 3d to 200d = Digital volume control is set as per configuration 201d = Digital volume control is set to 0 dB 202d = Digital volume control is set to 0.5 dB 203d to 253d = Digital volume control is set as per configuration 254d = Digital volume control is set to 26.5 dB 255d = Digital volume control is set to 27 dB |

8.6.1.2.49 CH1_CFG3 Register (Address = 0x3F) [Reset = 0x80]

CH1_CFG3 is shown in Figure 8-125 and described in Table 8-101.

Return to the Table 8-52.

This register is configuration register 3 for channel 1.

Figure 8-125. CH1_CFG3 Register

| | | | | | | | |
|---------------|---|---|---|----------|---|---|---|
| 7 | 6 | 5 | 4 | 3 | 2 | 1 | 0 |
| CH1_GCAL[3:0] | | | | RESERVED | | | |
| R/W-1000b | | | | R-0000b | | | |

Table 8-101. CH1_CFG3 Register Field Descriptions

| Bit | Field | Type | Reset | Description |
|-----|---------------|------|-------|--|
| 7-4 | CH1_GCAL[3:0] | R/W | 1000b | Channel 1 gain calibration. 0d = Gain calibration is set to -0.8 dB 1d = Gain calibration is set to -0.7 dB 2d = Gain calibration is set to -0.6 dB 3d to 7d = Gain calibration is set as per configuration 8d = Gain calibration is set to 0 dB 9d = Gain calibration is set to 0.1 dB 10d to 13d = Gain calibration is set as per configuration 14d = Gain calibration is set to 0.6 dB 15d = Gain calibration is set to 0.7 dB |
| 3-0 | RESERVED | R | 0000b | Reserved bits; Write only reset value |

8.6.1.2.50 CH1_CFG4 Register (Address = 0x40) [Reset = 0x0]

CH1_CFG4 is shown in Figure 8-126 and described in Table 8-102.

Return to the Table 8-52.

This register is configuration register 4 for channel 1.

Figure 8-126. CH1_CFG4 Register

| | | | | | | | |
|---------------|---|---|---|---|---|---|---|
| 7 | 6 | 5 | 4 | 3 | 2 | 1 | 0 |
| CH1_PCAL[7:0] | | | | | | | |
| R/W-00000000b | | | | | | | |

Table 8-102. CH1_CFG4 Register Field Descriptions

| Bit | Field | Type | Reset | Description |
|-----|---------------|------|-----------|---|
| 7-0 | CH1_PCAL[7:0] | R/W | 00000000b | Channel 1 phase calibration with modulator clock resolution. 0d = No phase calibration 1d = Phase calibration delay is set to one cycle of the modulator clock 2d = Phase calibration delay is set to two cycles of the modulator clock 3d to 254d = Phase calibration delay as per configuration 255d = Phase calibration delay is set to 255 cycles of the modulator clock |

8.6.1.2.51 CH2_CFG0 Register (Address = 0x41) [Reset = 0x10]

CH2_CFG0 is shown in [Figure 8-127](#) and described in [Table 8-103](#).

Return to the [Table 8-52](#).

This register is configuration register 0 for channel 2.

Figure 8-127. CH2_CFG0 Register

| 7 | 6 | 5 | 4 | 3 | 2 | 1 | 0 |
|-----------|----------------|--------|------------------|------------------|-----------|---|---|
| CH2_INTYP | CH2_INSRC[1:0] | CH2_DC | CH2_MIC_IN_RANGE | CH2_PGA_CFG[1:0] | CH2_AGCEN | | |
| R/W-0b | R/W-00b | R/W-1b | R/W-0b | R/W-00b | R/W-0b | | |

Table 8-103. CH2_CFG0 Register Field Descriptions

| Bit | Field | Type | Reset | Description |
|-----|------------------|------|-------|--|
| 7 | CH2_INTYP | R/W | 0b | Channel 2 input type. 0d = Microphone input 1d = Line input |
| 6-5 | CH2_INSRC[1:0] | R/W | 00b | Channel 2 input configuration. 0d = Analog differential input 1d = Analog single-ended input 2d = Reserved 3d = Reserved |
| 4 | CH2_DC | R/W | 1b | Channel 2 input coupling. 0d = AC-coupled input 1d = DC-coupled input |
| 3 | CH2_MIC_IN_RANGE | R/W | 0b | Channel 2 microphone input range. 0d = Low swing mode; Differential input AC signal full-scale of 2-VRMS supported provided DC differential common mode voltage IN1P - IN1M < 4.2 V. Single-ended AC signal 1-VRMS supported provided DC common mode voltage is < 2.1 V. 1d = High swing mode; Differential Input IN1P-IN1M peak voltage up to 14.14 V or single ended 7.07 V supported. User required to adjust the channel gain and digital volume control based on the max signal level used in system. |
| 2-1 | CH2_PGA_CFG[1:0] | R/W | 00b | Channel 2 CMRR Configuration. 0d = High SNR performance mode Dont use 2d = High CMRR performance mode 3d = Reserved |
| 0 | CH2_AGCEN | R/W | 0b | Channel 2 automatic gain controller (AGC) setting. 0d = AGC disabled 1d = AGC enabled based on the configuration of bit 3 in register 108 (P0_R108); This must be used only with AC-coupled input |

8.6.1.2.52 CH2_CFG1 Register (Address = 0x42) [Reset = 0x0]

CH2_CFG1 is shown in [Figure 8-128](#) and described in [Table 8-104](#).

Return to the [Table 8-52](#).

This register is configuration register 1 for channel 2.

Figure 8-128. CH2_CFG1 Register

| | | | | | | | |
|---------------|---|---|---|---|---|----------|----------|
| 7 | 6 | 5 | 4 | 3 | 2 | 1 | 0 |
| CH2_GAIN[5:0] | | | | | | RESERVED | RESERVED |
| R/W-000000b | | | | | | R/W-0b | R-0b |

Table 8-104. CH2_CFG1 Register Field Descriptions

| Bit | Field | Type | Reset | Description |
|-----|---------------|------|---------|--|
| 7-2 | CH2_GAIN[5:0] | R/W | 000000b | Channel 2 gain. 0d = Channel gain is set to 0 dB 1d = Channel gain is set to 1 dB 2d = Channel gain is set to 2 dB 3d to 41d = Channel gain is set as per configuration 42d = Channel gain is set to 42 dB 43d to 63d = Reserved |
| 1 | RESERVED | R/W | 0b | Reserved bit; Write only reset value |
| 0 | RESERVED | R | 0b | Reserved bit; Write only reset value |

8.6.1.2.53 CH2_CFG2 Register (Address = 0x43) [Reset = 0xC9]

CH2_CFG2 is shown in [Figure 8-129](#) and described in [Table 8-105](#).

Return to the [Table 8-52](#).

This register is configuration register 2 for channel 2.

Figure 8-129. CH2_CFG2 Register

| | | | | | | | |
|---------------|---|---|---|---|---|---|---|
| 7 | 6 | 5 | 4 | 3 | 2 | 1 | 0 |
| CH2_DVOL[7:0] | | | | | | | |
| R/W-11001001b | | | | | | | |

Table 8-105. CH2_CFG2 Register Field Descriptions

| Bit | Field | Type | Reset | Description |
|-----|---------------|------|-----------|--|
| 7-0 | CH2_DVOL[7:0] | R/W | 11001001b | Channel 2 digital volume control. 0d = Digital volume is muted 1d = Digital volume control is set to -100 dB 2d = Digital volume control is set to -99.5 dB 3d to 200d = Digital volume control is set as per configuration 201d = Digital volume control is set to 0 dB 202d = Digital volume control is set to 0.5 dB 203d to 253d = Digital volume control is set as per configuration 254d = Digital volume control is set to 26.5 dB 255d = Digital volume control is set to 27 dB |

8.6.1.2.54 CH2_CFG3 Register (Address = 0x44) [Reset = 0x80]

CH2_CFG3 is shown in [Figure 8-130](#) and described in [Table 8-106](#).

Return to the [Table 8-52](#).

This register is configuration register 3 for channel 2.

Figure 8-130. CH2_CFG3 Register

| | | | | | | | |
|---------------|---|---|---|----------|---|---|---|
| 7 | 6 | 5 | 4 | 3 | 2 | 1 | 0 |
| CH2_GCAL[3:0] | | | | RESERVED | | | |
| R/W-1000b | | | | R-0000b | | | |

Table 8-106. CH2_CFG3 Register Field Descriptions

| Bit | Field | Type | Reset | Description |
|-----|---------------|------|-------|--|
| 7-4 | CH2_GCAL[3:0] | R/W | 1000b | Channel 2 gain calibration. 0d = Gain calibration is set to -0.8 dB 1d = Gain calibration is set to -0.7 dB 2d = Gain calibration is set to -0.6 dB 3d to 7d = Gain calibration is set as per configuration 8d = Gain calibration is set to 0 dB 9d = Gain calibration is set to 0.1 dB 10d to 13d = Gain calibration is set as per configuration 14d = Gain calibration is set to 0.6 dB 15d = Gain calibration is set to 0.7 dB |
| 3-0 | RESERVED | R | 0000b | Reserved bits; Write only reset value |

8.6.1.2.55 CH2_CFG4 Register (Address = 0x45) [Reset = 0x0]

CH2_CFG4 is shown in [Figure 8-131](#) and described in [Table 8-107](#).

Return to the [Table 8-52](#).

This register is configuration register 4 for channel 2.

Figure 8-131. CH2_CFG4 Register

| | | | | | | | |
|---------------|---|---|---|---|---|---|---|
| 7 | 6 | 5 | 4 | 3 | 2 | 1 | 0 |
| CH2_PCAL[7:0] | | | | | | | |
| R/W-00000000b | | | | | | | |

Table 8-107. CH2_CFG4 Register Field Descriptions

| Bit | Field | Type | Reset | Description |
|-----|---------------|------|-----------|---|
| 7-0 | CH2_PCAL[7:0] | R/W | 00000000b | Channel 2 phase calibration with modulator clock resolution. 0d = No phase calibration 1d = Phase calibration delay is set to one cycle of the modulator clock 2d = Phase calibration delay is set to two cycles of the modulator clock 3d to 254d = Phase calibration delay as per configuration 255d = Phase calibration delay is set to 255 cycles of the modulator clock |

8.6.1.2.56 CH3_CFG0 Register (Address = 0x46) [Reset = 0x10]

CH3_CFG0 is shown in [Figure 8-132](#) and described in [Table 8-108](#).

Return to the [Table 8-52](#).

This register is configuration register 0 for channel 3.

Figure 8-132. CH3_CFG0 Register

| | | | | | | | |
|-----------|----------------|---|--------|----------------------|------------------|---|-----------|
| 7 | 6 | 5 | 4 | 3 | 2 | 1 | 0 |
| CH3_INTYP | CH3_INSRC[1:0] | | CH3_DC | CH3_MIC_IN_R ANGE | CH3_PGA_CFG[1:0] | | CH3_AGCEN |
| R/W-0b | R/W-00b | | R/W-1b | R/W-0b | R/W-00b | | R/W-0b |

Table 8-108. CH3_CFG0 Register Field Descriptions

| Bit | Field | Type | Reset | Description |
|-----|------------------|------|-------|--|
| 7 | CH3_INTYP | R/W | 0b | Channel 3 input type. 0d = Microphone input 1d = Line input |
| 6-5 | CH3_INSRC[1:0] | R/W | 00b | Channel 3 input configuration. 0d = Analog differential input 1d = Analog single-ended input 2d = Reserved 3d = Reserved |
| 4 | CH3_DC | R/W | 1b | Channel 3 input coupling. 0d = AC-coupled input 1d = DC-coupled input |
| 3 | CH3_MIC_IN_RANGE | R/W | 0b | Channel 3 microphone input range. 0d = Low swing mode; Differential input AC signal full-scale of 2-VRMS supported provided DC differential common mode voltage IN1P - IN1M < 4.2 V. Single-ended AC signal 1-VRMS supported provided DC common mode voltage is < 2.1 V. 1d = High swing mode; Differential Input IN1P-IN1M peak voltage up to 14.14 V or single ended 7.07 V supported. User required to adjust the channel gain and digital volume control based on the max signal level used in system. |
| 2-1 | CH3_PGA_CFG[1:0] | R/W | 00b | Channel 3 CMRR Configuration. 0d = High SNR performance mode Dont use 2d = High CMRR performance mode 3d = Reserved |
| 0 | CH3_AGCEN | R/W | 0b | Channel 3 automatic gain controller (AGC) setting. 0d = AGC disabled 1d = AGC enabled based on the configuration of bit 3 in register 108 (P0_R108); This must be used only with AC-coupled input |

8.6.1.2.57 CH3_CFG1 Register (Address = 0x47) [Reset = 0x0]

CH3_CFG1 is shown in [Figure 8-133](#) and described in [Table 8-109](#).

Return to the [Table 8-52](#).

This register is configuration register 1 for channel 3.

Figure 8-133. CH3_CFG1 Register

| 7 | 6 | 5 | 4 | 3 | 2 | 1 | 0 |
|---------------|---|---|---|---|---|----------|----------|
| CH3_GAIN[5:0] | | | | | | RESERVED | RESERVED |
| R/W-000000b | | | | | | R/W-0b | R-0b |

Table 8-109. CH3_CFG1 Register Field Descriptions

| Bit | Field | Type | Reset | Description |
|-----|---------------|------|---------|--|
| 7-2 | CH3_GAIN[5:0] | R/W | 000000b | Channel 3 gain. 0d = Channel gain is set to 0 dB 1d = Channel gain is set to 1 dB 2d = Channel gain is set to 2 dB 3d to 41d = Channel gain is set as per configuration 42d = Channel gain is set to 42 dB 43d to 63d = Reserved |
| 1 | RESERVED | R/W | 0b | Reserved bit; Write only reset value |
| 0 | RESERVED | R | 0b | Reserved bit; Write only reset value |

8.6.1.2.58 CH3_CFG2 Register (Address = 0x48) [Reset = 0xC9]

CH3_CFG2 is shown in [Figure 8-134](#) and described in [Table 8-110](#).

Return to the [Table 8-52](#).

This register is configuration register 2 for channel 3.

Figure 8-134. CH3_CFG2 Register

| | | | | | | | |
|---------------|---|---|---|---|---|---|---|
| 7 | 6 | 5 | 4 | 3 | 2 | 1 | 0 |
| CH3_DVOL[7:0] | | | | | | | |
| R/W-11001001b | | | | | | | |

Table 8-110. CH3_CFG2 Register Field Descriptions

| Bit | Field | Type | Reset | Description |
|-----|---------------|------|-----------|--|
| 7-0 | CH3_DVOL[7:0] | R/W | 11001001b | Channel 3 digital volume control. 0d = Digital volume is muted 1d = Digital volume control is set to -100 dB 2d = Digital volume control is set to -99.5 dB 3d to 200d = Digital volume control is set as per configuration 201d = Digital volume control is set to 0 dB 202d = Digital volume control is set to 0.5 dB 203d to 253d = Digital volume control is set as per configuration 254d = Digital volume control is set to 26.5 dB 255d = Digital volume control is set to 27 dB |

8.6.1.2.59 CH3_CFG3 Register (Address = 0x49) [Reset = 0x80]

CH3_CFG3 is shown in [Figure 8-135](#) and described in [Table 8-111](#).

Return to the [Table 8-52](#).

This register is configuration register 3 for channel 3.

Figure 8-135. CH3_CFG3 Register

| | | | | | | | |
|---------------|---|---|---|----------|---|---|---|
| 7 | 6 | 5 | 4 | 3 | 2 | 1 | 0 |
| CH3_GCAL[3:0] | | | | RESERVED | | | |
| R/W-1000b | | | | R-0000b | | | |

Table 8-111. CH3_CFG3 Register Field Descriptions

| Bit | Field | Type | Reset | Description |
|-----|---------------|------|-------|--|
| 7-4 | CH3_GCAL[3:0] | R/W | 1000b | Channel 3 gain calibration. 0d = Gain calibration is set to -0.8 dB 1d = Gain calibration is set to -0.7 dB 2d = Gain calibration is set to -0.6 dB 3d to 7d = Gain calibration is set as per configuration 8d = Gain calibration is set to 0 dB 9d = Gain calibration is set to 0.1 dB 10d to 13d = Gain calibration is set as per configuration 14d = Gain calibration is set to 0.6 dB 15d = Gain calibration is set to 0.7 dB |
| 3-0 | RESERVED | R | 0000b | Reserved bits; Write only reset value |

8.6.1.2.60 CH3_CFG4 Register (Address = 0x4A) [Reset = 0x0]

CH3_CFG4 is shown in [Figure 8-136](#) and described in [Table 8-112](#).

Return to the [Table 8-52](#).

This register is configuration register 4 for channel 3.

Figure 8-136. CH3_CFG4 Register

| | | | | | | | |
|---------------|---|---|---|---|---|---|---|
| 7 | 6 | 5 | 4 | 3 | 2 | 1 | 0 |
| CH3_PCAL[7:0] | | | | | | | |
| R/W-00000000b | | | | | | | |

Table 8-112. CH3_CFG4 Register Field Descriptions

| Bit | Field | Type | Reset | Description |
|-----|---------------|------|-----------|---|
| 7-0 | CH3_PCAL[7:0] | R/W | 00000000b | Channel 3 phase calibration with modulator clock resolution. 0d = No phase calibration 1d = Phase calibration delay is set to one cycle of the modulator clock 2d = Phase calibration delay is set to two cycles of the modulator clock 3d to 254d = Phase calibration delay as per configuration 255d = Phase calibration delay is set to 255 cycles of the modulator clock |

8.6.1.2.61 CH4_CFG0 Register (Address = 0x4B) [Reset = 0x10]

CH4_CFG0 is shown in [Figure 8-137](#) and described in [Table 8-113](#).

Return to the [Table 8-52](#).

This register is configuration register 0 for channel 4.

Figure 8-137. CH4_CFG0 Register

| | | | | | | | |
|-----------|----------------|--------|------------------|------------------|-----------|---|---|
| 7 | 6 | 5 | 4 | 3 | 2 | 1 | 0 |
| CH4_INTYP | CH4_INSRC[1:0] | CH4_DC | CH4_MIC_IN_RANGE | CH4_PGA_CFG[1:0] | CH4_AGCEN | | |
| R/W-0b | R/W-00b | R/W-1b | R/W-0b | R/W-00b | R/W-0b | | |

Table 8-113. CH4_CFG0 Register Field Descriptions

| Bit | Field | Type | Reset | Description |
|-----|------------------|------|-------|--|
| 7 | CH4_INTYP | R/W | 0b | Channel 4 input type. 0d = Microphone input 1d = Line input |
| 6-5 | CH4_INSRC[1:0] | R/W | 00b | Channel 4 input configuration. 0d = Analog differential input 1d = Analog single-ended input 2d = Reserved 3d = Reserved |
| 4 | CH4_DC | R/W | 1b | Channel 4 input coupling. 0d = AC-coupled input 1d = DC-coupled input |
| 3 | CH4_MIC_IN_RANGE | R/W | 0b | Channel 4 microphone input range. 0d = Low swing mode; Differential input AC signal full-scale of 2-VRMS supported provided DC differential common mode voltage IN1P - IN1M < 4.2 V. Single-ended AC signal 1-VRMS supported provided DC common mode voltage is < 2.1 V. 1d = High swing mode; Differential Input IN1P-IN1M peak voltage up to 14.14 V or single ended 7.07 V supported. User required to adjust the channel gain and digital volume control based on the max signal level used in system. |
| 2-1 | CH4_PGA_CFG[1:0] | R/W | 00b | Channel 4 CMRR Configuration. 0d = High SNR performance mode Dont use 2d = High CMRR performance mode 3d = Reserved |

Table 8-113. CH4_CFG0 Register Field Descriptions (continued)

| Bit | Field | Type | Reset | Description |
|-----|-----------|------|-------|---|
| 0 | CH4_AGCEN | R/W | 0b | Channel 4 automatic gain controller (AGC) setting. 0d = AGC disabled 1d = AGC enabled based on the configuration of bit 3 in register 108 (P0_R108); This must be used only with AC-coupled input |

8.6.1.2.62 CH4_CFG1 Register (Address = 0x4C) [Reset = 0x0]

CH4_CFG1 is shown in [Figure 8-138](#) and described in [Table 8-114](#).

Return to the [Table 8-52](#).

This register is configuration register 1 for channel 4.

Figure 8-138. CH4_CFG1 Register

| 7 | 6 | 5 | 4 | 3 | 2 | 1 | 0 |
|---------------|---|---|---|---|---|----------|----------|
| CH4_GAIN[5:0] | | | | | | RESERVED | RESERVED |
| R/W-000000b | | | | | | R/W-0b | R-0b |

Table 8-114. CH4_CFG1 Register Field Descriptions

| Bit | Field | Type | Reset | Description |
|-----|---------------|------|---------|--|
| 7-2 | CH4_GAIN[5:0] | R/W | 000000b | Channel 4 gain. 0d = Channel gain is set to 0 dB 1d = Channel gain is set to 1 dB 2d = Channel gain is set to 2 dB 3d to 41d = Channel gain is set as per configuration 42d = Channel gain is set to 42 dB 43d to 63d = Reserved |
| 1 | RESERVED | R/W | 0b | Reserved bit; Write only reset value |
| 0 | RESERVED | R | 0b | Reserved bit; Write only reset value |

8.6.1.2.63 CH4_CFG2 Register (Address = 0x4D) [Reset = 0xC9]

CH4_CFG2 is shown in [Figure 8-139](#) and described in [Table 8-115](#).

Return to the [Table 8-52](#).

This register is configuration register 2 for channel 4.

Figure 8-139. CH4_CFG2 Register

| 7 | 6 | 5 | 4 | 3 | 2 | 1 | 0 |
|---------------|---|---|---|---|---|---|---|
| CH4_DVOL[7:0] | | | | | | | |
| R/W-11001001b | | | | | | | |

Table 8-115. CH4_CFG2 Register Field Descriptions

| Bit | Field | Type | Reset | Description |
|-----|---------------|------|-----------|--|
| 7-0 | CH4_DVOL[7:0] | R/W | 11001001b | Channel 4 digital volume control. 0d = Digital volume is muted 1d = Digital volume control is set to -100 dB 2d = Digital volume control is set to -99.5 dB 3d to 200d = Digital volume control is set as per configuration 201d = Digital volume control is set to 0 dB 202d = Digital volume control is set to 0.5 dB 203d to 253d = Digital volume control is set as per configuration 254d = Digital volume control is set to 26.5 dB 255d = Digital volume control is set to 27 dB |

8.6.1.2.64 CH4_CFG3 Register (Address = 0x4E) [Reset = 0x80]

CH4_CFG3 is shown in [Figure 8-140](#) and described in [Table 8-116](#).

Return to the [Table 8-52](#).

This register is configuration register 3 for channel 4.

Figure 8-140. CH4_CFG3 Register

| | | | | | | | |
|---------------|---|---|---|----------|---|---|---|
| 7 | 6 | 5 | 4 | 3 | 2 | 1 | 0 |
| CH4_GCAL[3:0] | | | | RESERVED | | | |
| R/W-1000b | | | | R-0000b | | | |

Table 8-116. CH4_CFG3 Register Field Descriptions

| Bit | Field | Type | Reset | Description |
|-----|---------------|------|-------|--|
| 7-4 | CH4_GCAL[3:0] | R/W | 1000b | Channel 4 gain calibration. 0d = Gain calibration is set to -0.8 dB 1d = Gain calibration is set to -0.7 dB 2d = Gain calibration is set to -0.6 dB 3d to 7d = Gain calibration is set as per configuration 8d = Gain calibration is set to 0 dB 9d = Gain calibration is set to 0.1 dB 10d to 13d = Gain calibration is set as per configuration 14d = Gain calibration is set to 0.6 dB 15d = Gain calibration is set to 0.7 dB |
| 3-0 | RESERVED | R | 0000b | Reserved bits; Write only reset value |

8.6.1.2.65 CH4_CFG4 Register (Address = 0x4F) [Reset = 0x0]

CH4_CFG4 is shown in [Figure 8-141](#) and described in [Table 8-117](#).

Return to the [Table 8-52](#).

This register is configuration register 4 for channel 4.

Figure 8-141. CH4_CFG4 Register

| | | | | | | | |
|---------------|---|---|---|---|---|---|---|
| 7 | 6 | 5 | 4 | 3 | 2 | 1 | 0 |
| CH4_PCAL[7:0] | | | | | | | |
| R/W-00000000b | | | | | | | |

Table 8-117. CH4_CFG4 Register Field Descriptions

| Bit | Field | Type | Reset | Description |
|-----|---------------|------|-----------|---|
| 7-0 | CH4_PCAL[7:0] | R/W | 00000000b | Channel 4 phase calibration with modulator clock resolution. 0d = No phase calibration 1d = Phase calibration delay is set to one cycle of the modulator clock 2d = Phase calibration delay is set to two cycles of the modulator clock 3d to 254d = Phase calibration delay as per configuration 255d = Phase calibration delay is set to 255 cycles of the modulator clock |

8.6.1.2.66 CH5_CFG0 Register (Address = 0x50) [Reset = 0x10]

CH5_CFG0 is shown in [Figure 8-142](#) and described in [Table 8-118](#).

Return to the [Table 8-52](#).

This register is configuration register 0 for channel 5.

Figure 8-142. CH5_CFG0 Register

| | | | | | | | |
|----------|----------------|---|----------|----------|----------|---|----------|
| 7 | 6 | 5 | 4 | 3 | 2 | 1 | 0 |
| RESERVED | CH5_INSRC[1:0] | | RESERVED | RESERVED | RESERVED | | RESERVED |
| R/W-0b | R/W-00b | | R/W-1b | R/W-0b | R/W-00b | | R/W-0b |

Table 8-118. CH5_CFG0 Register Field Descriptions

| Bit | Field | Type | Reset | Description |
|-----|----------------|------|-------|--|
| 7 | RESERVED | R/W | 0b | Reserved bit; Write only reset value |
| 6-5 | CH5_INSRC[1:0] | R/W | 00b | Channel 5 input configuration. 0d = Reserved 1d = Reserved 2d = Digital microphone PDM input (Configure GPIO's/GPI's pin accordingly for PDMDIN1 and PDMCLK) 3d = Channel-5 digital filter input is generated same as channel 1 digital filter input (cloned input mode) |
| 4 | RESERVED | R/W | 1b | Reserved bit; Write only reset value |
| 3 | RESERVED | R/W | 0b | Reserved bit; Write only reset value |
| 2-1 | RESERVED | R/W | 00b | Reserved bits; Write only reset values |
| 0 | RESERVED | R/W | 0b | Reserved bit; Write only reset value |

8.6.1.2.67 CH5_CFG2 Register (Address = 0x52) [Reset = 0xC9]

CH5_CFG2 is shown in [Figure 8-143](#) and described in [Table 8-119](#).

Return to the [Table 8-52](#).

This register is configuration register 2 for channel 5.

Figure 8-143. CH5_CFG2 Register

| | | | | | | | |
|---------------|---|---|---|---|---|---|---|
| 7 | 6 | 5 | 4 | 3 | 2 | 1 | 0 |
| CH5_DVOL[7:0] | | | | | | | |
| R/W-11001001b | | | | | | | |

Table 8-119. CH5_CFG2 Register Field Descriptions

| Bit | Field | Type | Reset | Description |
|-----|---------------|------|-----------|--|
| 7-0 | CH5_DVOL[7:0] | R/W | 11001001b | Channel 5 digital volume control. 0d = Digital volume is muted 1d = Digital volume control is set to -100 dB 2d = Digital volume control is set to -99.5 dB 3d to 200d = Digital volume control is set as per configuration 201d = Digital volume control is set to 0 dB 202d = Digital volume control is set to 0.5 dB 203d to 253d = Digital volume control is set as per configuration 254d = Digital volume control is set to 26.5 dB 255d = Digital volume control is set to 27 dB |

8.6.1.2.68 CH5_CFG3 Register (Address = 0x53) [Reset = 0x80]

CH5_CFG3 is shown in [Figure 8-144](#) and described in [Table 8-120](#).

Return to the [Table 8-52](#).

This register is configuration register 3 for channel 5.

Figure 8-144. CH5_CFG3 Register

| | | | | | | | |
|---------------|---|---|---|----------|---|---|---|
| 7 | 6 | 5 | 4 | 3 | 2 | 1 | 0 |
| CH5_GCAL[3:0] | | | | RESERVED | | | |

Figure 8-144. CH5_CFG3 Register (continued)

R/W-1000b

R-0000b

Table 8-120. CH5_CFG3 Register Field Descriptions

| Bit | Field | Type | Reset | Description |
|-----|---------------|------|-------|--|
| 7-4 | CH5_GCAL[3:0] | R/W | 1000b | Channel 5 gain calibration. 0d = Gain calibration is set to -0.8 dB 1d = Gain calibration is set to -0.7 dB 2d = Gain calibration is set to -0.6 dB 3d to 7d = Gain calibration is set as per configuration 8d = Gain calibration is set to 0 dB 9d = Gain calibration is set to 0.1 dB 10d to 13d = Gain calibration is set as per configuration 14d = Gain calibration is set to 0.6 dB 15d = Gain calibration is set to 0.7 dB |
| 3-0 | RESERVED | R | 0000b | Reserved bits; Write only reset value |

8.6.1.2.69 CH5_CFG4 Register (Address = 0x54) [Reset = 0x0]

CH5_CFG4 is shown in Figure 8-145 and described in Table 8-121.

Return to the Table 8-52.

This register is configuration register 4 for channel 5.

Figure 8-145. CH5_CFG4 Register

| 7 | 6 | 5 | 4 | 3 | 2 | 1 | 0 |
|---------------|---|---|---|---|---|---|---|
| CH5_PCAL[7:0] | | | | | | | |
| R/W-00000000b | | | | | | | |

Table 8-121. CH5_CFG4 Register Field Descriptions

| Bit | Field | Type | Reset | Description |
|-----|---------------|------|-----------|---|
| 7-0 | CH5_PCAL[7:0] | R/W | 00000000b | Channel 5 phase calibration with modulator clock resolution. 0d = No phase calibration 1d = Phase calibration delay is set to one cycle of the modulator clock 2d = Phase calibration delay is set to two cycles of the modulator clock 3d to 254d = Phase calibration delay as per configuration 255d = Phase calibration delay is set to 255 cycles of the modulator clock |

8.6.1.2.70 CH6_CFG0 Register (Address = 0x55) [Reset = 0x10]

CH6_CFG0 is shown in Figure 8-146 and described in Table 8-122.

Return to the Table 8-52.

This register is configuration register 0 for channel 6.

Figure 8-146. CH6_CFG0 Register

| 7 | 6 | 5 | 4 | 3 | 2 | 1 | 0 |
|----------|----------------|----------|----------|----------|----------|----------|----------|
| RESERVED | CH6_INSRC[1:0] | RESERVED | RESERVED | RESERVED | RESERVED | RESERVED | RESERVED |
| R/W-0b | R/W-00b | R/W-1b | R/W-0b | R/W-00b | R/W-00b | R/W-0b | R/W-0b |

Table 8-122. CH6_CFG0 Register Field Descriptions

| Bit | Field | Type | Reset | Description |
|-----|----------|------|-------|--------------------------------------|
| 7 | RESERVED | R/W | 0b | Reserved bit; Write only reset value |

Table 8-122. CH6_CFG0 Register Field Descriptions (continued)

| Bit | Field | Type | Reset | Description |
|-----|----------------|------|-------|--|
| 6-5 | CH6_INSRC[1:0] | R/W | 00b | Channel 6 input configuration. 0d = Reserved 1d = Reserved 2d = Digital microphone PDM input (Configure GPIO's/GPI's pin accordingly for PDMDIN1 and PDMCLK) 3d = Channel-5 digital filter input is generated same as channel 1 digital filter input (cloned input mode) |
| 4 | RESERVED | R/W | 1b | Reserved bit; Write only reset value |
| 3 | RESERVED | R/W | 0b | Reserved bit; Write only reset value |
| 2-1 | RESERVED | R/W | 00b | Reserved bits; Write only reset values |
| 0 | RESERVED | R/W | 0b | Reserved bit; Write only reset value |

8.6.1.2.71 CH6_CFG2 Register (Address = 0x57) [Reset = 0xC9]

CH6_CFG2 is shown in [Figure 8-147](#) and described in [Table 8-123](#).

Return to the [Table 8-52](#).

This register is configuration register 2 for channel 6.

Figure 8-147. CH6_CFG2 Register

| 7 | 6 | 5 | 4 | 3 | 2 | 1 | 0 |
|---------------|---|---|---|---|---|---|---|
| CH6_DVOL[7:0] | | | | | | | |
| R/W-11001001b | | | | | | | |

Table 8-123. CH6_CFG2 Register Field Descriptions

| Bit | Field | Type | Reset | Description |
|-----|---------------|------|-----------|--|
| 7-0 | CH6_DVOL[7:0] | R/W | 11001001b | Channel 6 digital volume control. 0d = Digital volume is muted 1d = Digital volume control is set to -100 dB 2d = Digital volume control is set to -99.5 dB 3d to 200d = Digital volume control is set as per configuration 201d = Digital volume control is set to 0 dB 202d = Digital volume control is set to 0.5 dB 203d to 253d = Digital volume control is set as per configuration 254d = Digital volume control is set to 26.5 dB 255d = Digital volume control is set to 27 dB |

8.6.1.2.72 CH6_CFG3 Register (Address = 0x58) [Reset = 0x80]

CH6_CFG3 is shown in [Figure 8-148](#) and described in [Table 8-124](#).

Return to the [Table 8-52](#).

This register is configuration register 3 for channel 6.

Figure 8-148. CH6_CFG3 Register

| 7 | 6 | 5 | 4 | 3 | 2 | 1 | 0 |
|---------------|---|---|---|----------|---|---|---|
| CH6_GCAL[3:0] | | | | RESERVED | | | |
| R/W-1000b | | | | R-0000b | | | |

Table 8-124. CH6_CFG3 Register Field Descriptions

| Bit | Field | Type | Reset | Description |
|-----|---------------|------|-------|--|
| 7-4 | CH6_GCAL[3:0] | R/W | 1000b | Channel 6 gain calibration. 0d = Gain calibration is set to -0.8 dB 1d = Gain calibration is set to -0.7 dB 2d = Gain calibration is set to -0.6 dB 3d to 7d = Gain calibration is set as per configuration 8d = Gain calibration is set to 0 dB 9d = Gain calibration is set to 0.1 dB 10d to 13d = Gain calibration is set as per configuration 14d = Gain calibration is set to 0.6 dB 15d = Gain calibration is set to 0.7 dB |
| 3-0 | RESERVED | R | 0000b | Reserved bits; Write only reset value |

8.6.1.2.73 CH6_CFG4 Register (Address = 0x59) [Reset = 0x0]

CH6_CFG4 is shown in [Figure 8-149](#) and described in [Table 8-125](#).

Return to the [Table 8-52](#).

This register is configuration register 4 for channel 6.

Figure 8-149. CH6_CFG4 Register

| | | | | | | | |
|---------------|---|---|---|---|---|---|---|
| 7 | 6 | 5 | 4 | 3 | 2 | 1 | 0 |
| CH6_PCAL[7:0] | | | | | | | |
| R/W-00000000b | | | | | | | |

Table 8-125. CH6_CFG4 Register Field Descriptions

| Bit | Field | Type | Reset | Description |
|-----|---------------|------|-----------|---|
| 7-0 | CH6_PCAL[7:0] | R/W | 00000000b | Channel 6 phase calibration with modulator clock resolution. 0d = No phase calibration 1d = Phase calibration delay is set to one cycle of the modulator clock 2d = Phase calibration delay is set to two cycles of the modulator clock 3d to 254d = Phase calibration delay as per configuration 255d = Phase calibration delay is set to 255 cycles of the modulator clock |

8.6.1.2.74 CH7_CFG0 Register (Address = 0x5A) [Reset = 0x0]

CH7_CFG0 is shown in [Figure 8-150](#) and described in [Table 8-126](#).

Return to the [Table 8-52](#).

This register is configuration register 0 for channel 7.

Figure 8-150. CH7_CFG0 Register

| | | | | | | | |
|----------|----------------|---|----------|---|---|---|---|
| 7 | 6 | 5 | 4 | 3 | 2 | 1 | 0 |
| RESERVED | CH7_INSRC[1:0] | | RESERVED | | | | |
| R-0b | R/W-00b | | R-00000b | | | | |

Table 8-126. CH7_CFG0 Register Field Descriptions

| Bit | Field | Type | Reset | Description |
|-----|----------|------|-------|--------------------------------------|
| 7 | RESERVED | R | 0b | Reserved bit; Write only reset value |

Table 8-126. CH7_CFG0 Register Field Descriptions (continued)

| Bit | Field | Type | Reset | Description |
|-----|----------------|------|--------|---|
| 6-5 | CH7_INSRC[1:0] | R/W | 00b | Channel-7 Input Configuration. 0d = Digital Microphone PDM Input (Configure GPIO's/GPI's pin accordingly for PDMDIN2 and PDMCLK) 1d = Digital Microphone PDM Input (Configure GPIO's/GPI's pin accordingly for PDMDIN2 and PDMCLK) 2d = Digital Microphone PDM Input (Configure GPIO's/GPI's pin accordingly for PDMDIN2 and PDMCLK) 3d = Channel-7 Digital Filter Input is generated same as Channel-3 Digital Filter Input (Cloned Input) |
| 4-0 | RESERVED | R | 00000b | Reserved bits; Write only reset value |

8.6.1.2.75 CH7_CFG2 Register (Address = 0x5C) [Reset = 0xC9]

CH7_CFG2 is shown in [Figure 8-151](#) and described in [Table 8-127](#).

Return to the [Table 8-52](#).

This register is configuration register 2 for channel 7.

Figure 8-151. CH7_CFG2 Register

| 7 | 6 | 5 | 4 | 3 | 2 | 1 | 0 |
|---------------|---|---|---|---|---|---|---|
| CH7_DVOL[7:0] | | | | | | | |
| R/W-11001001b | | | | | | | |

Table 8-127. CH7_CFG2 Register Field Descriptions

| Bit | Field | Type | Reset | Description |
|-----|---------------|------|-----------|--|
| 7-0 | CH7_DVOL[7:0] | R/W | 11001001b | Channel-7 Digital Volume Control. 0d = Digital Volume is Mute 1d = Digital Volume Control set to -100 dB 2d = Digital Volume Control set to -99.5 dB 3d to 200d = Digital Volume Control set to as per configuration 201d = Digital Volume Control set to 0 dB 202d = Digital Volume Control set to +0.5 dB 203d to 253d = Digital Volume Control set to as per configuration 254d = Digital Volume Control set to +26.5 dB 255d = Digital Volume Control set to +27 dB |

8.6.1.2.76 CH7_CFG3 Register (Address = 0x5D) [Reset = 0x80]

CH7_CFG3 is shown in [Figure 8-152](#) and described in [Table 8-128](#).

Return to the [Table 8-52](#).

This register is configuration register 3 for channel 7.

Figure 8-152. CH7_CFG3 Register

| 7 | 6 | 5 | 4 | 3 | 2 | 1 | 0 |
|---------------|---|---|---|----------|---|---|---|
| CH7_GCAL[3:0] | | | | RESERVED | | | |
| R/W-1000b | | | | R-0000b | | | |

Table 8-128. CH7_CFG3 Register Field Descriptions

| Bit | Field | Type | Reset | Description |
|-----|---------------|------|-------|--|
| 7-4 | CH7_GCAL[3:0] | R/W | 1000b | Channel-7 Gain Calibration. 0d = Gain Calibration set to -0.8 dB 1d = Gain Calibration set to -0.7 dB 2d = Gain Calibration set to -0.6 dB 3d to 7d = Gain Calibration set to as per configuration 8d = Gain Calibration set to 0 dB 9d = Gain Calibration set to +0.1 dB 10d to 13d = Gain Calibration set to as per configuration 14d = Gain Calibration set to +0.6 dB 15d = Gain Calibration set to +0.7 dB |
| 3-0 | RESERVED | R | 0000b | Reserved bits; Write only reset value |

8.6.1.2.77 CH7_CFG4 Register (Address = 0x5E) [Reset = 0x0]

CH7_CFG4 is shown in [Figure 8-153](#) and described in [Table 8-129](#).

Return to the [Table 8-52](#).

This register is configuration register 4 for channel 7.

Figure 8-153. CH7_CFG4 Register

| | | | | | | | |
|---------------|---|---|---|---|---|---|---|
| 7 | 6 | 5 | 4 | 3 | 2 | 1 | 0 |
| CH7_PCAL[7:0] | | | | | | | |
| R/W-0000000b | | | | | | | |

Table 8-129. CH7_CFG4 Register Field Descriptions

| Bit | Field | Type | Reset | Description |
|-----|---------------|------|----------|---|
| 7-0 | CH7_PCAL[7:0] | R/W | 0000000b | Channel-7 Phase Calibration with modulator clock resolution. 0d = Phase Calibration with 0-cycle of modulator clock delay 1d = Phase Calibration with 1-cycles of modulator clock delay 2d = Phase Calibration with 1-cycles of modulator clock delay 3d to 254d = Delay Value is as per configuration 255d = Phase Calibration with 255-cycles of modulator clock delay |

8.6.1.2.78 CH8_CFG0 Register (Address = 0x5F) [Reset = 0x0]

CH8_CFG0 is shown in [Figure 8-154](#) and described in [Table 8-130](#).

Return to the [Table 8-52](#).

This register is configuration register 0 for channel 8.

Figure 8-154. CH8_CFG0 Register

| | | | | | | | |
|----------|----------------|---|----------|---|---|---|---|
| 7 | 6 | 5 | 4 | 3 | 2 | 1 | 0 |
| RESERVED | CH8_INSRC[1:0] | | RESERVED | | | | |
| R-0b | R/W-00b | | R-00000b | | | | |

Table 8-130. CH8_CFG0 Register Field Descriptions

| Bit | Field | Type | Reset | Description |
|-----|----------|------|-------|--------------------------------------|
| 7 | RESERVED | R | 0b | Reserved bit; Write only reset value |

Table 8-130. CH8_CFG0 Register Field Descriptions (continued)

| Bit | Field | Type | Reset | Description |
|-----|----------------|------|--------|---|
| 6-5 | CH8_INSRC[1:0] | R/W | 00b | Channel-8 Input Configuration. 0d = Digital Microphone PDM Input (Configure GPIO's/GPI's pin accordingly for PDMDIN2 and PDMCLK) 1d = Digital Microphone PDM Input (Configure GPIO's/GPI's pin accordingly for PDMDIN2 and PDMCLK) 2d = Digital Microphone PDM Input (Configure GPIO's/GPI's pin accordingly for PDMDIN2 and PDMCLK) 3d = Channel-8 Digital Filter Input is generated same as Channel-4 Digital Filter Input (Cloned Input) |
| 4-0 | RESERVED | R | 00000b | Reserved bits; Write only reset value |

8.6.1.2.79 CH8_CFG2 Register (Address = 0x61) [Reset = 0xC9]

CH8_CFG2 is shown in [Figure 8-155](#) and described in [Table 8-131](#).

Return to the [Table 8-52](#).

This register is configuration register 2 for channel 8.

Figure 8-155. CH8_CFG2 Register

| | | | | | | | |
|---------------|---|---|---|---|---|---|---|
| 7 | 6 | 5 | 4 | 3 | 2 | 1 | 0 |
| CH8_DVOL[7:0] | | | | | | | |
| R/W-11001001b | | | | | | | |

Table 8-131. CH8_CFG2 Register Field Descriptions

| Bit | Field | Type | Reset | Description |
|-----|---------------|------|-----------|--|
| 7-0 | CH8_DVOL[7:0] | R/W | 11001001b | Channel-8 Digital Volume Control. 0d = Digital Volume is Mute 1d = Digital Volume Control set to -100 dB 2d = Digital Volume Control set to -99.5 dB 3d to 200d = Digital Volume Control set to as per configuration 201d = Digital Volume Control set to 0 dB 202d = Digital Volume Control set to +0.5 dB 203d to 253d = Digital Volume Control set to as per configuration 254d = Digital Volume Control set to +26.5 dB 255d = Digital Volume Control set to +27 dB |

8.6.1.2.80 CH8_CFG3 Register (Address = 0x62) [Reset = 0x80]

CH8_CFG3 is shown in [Figure 8-156](#) and described in [Table 8-132](#).

Return to the [Table 8-52](#).

This register is configuration register 3 for channel 8.

Figure 8-156. CH8_CFG3 Register

| | | | | | | | |
|---------------|---|---|---|----------|---|---|---|
| 7 | 6 | 5 | 4 | 3 | 2 | 1 | 0 |
| CH8_GCAL[3:0] | | | | RESERVED | | | |
| R/W-1000b | | | | R-0000b | | | |

Table 8-132. CH8_CFG3 Register Field Descriptions

| Bit | Field | Type | Reset | Description |
|-----|---------------|------|-------|--|
| 7-4 | CH8_GCAL[3:0] | R/W | 1000b | Channel-8 Gain Calibration. 0d = Gain Calibration set to -0.8 dB 1d = Gain Calibration set to -0.7 dB 2d = Gain Calibration set to -0.6 dB 3d to 7d = Gain Calibration set to as per configuration 8d = Gain Calibration set to 0 dB 9d = Gain Calibration set to +0.1 dB 10d to 13d = Gain Calibration set to as per configuration 14d = Gain Calibration set to +0.6 dB 15d = Gain Calibration set to +0.7 dB |
| 3-0 | RESERVED | R | 0000b | Reserved bits; Write only reset value |

8.6.1.2.81 CH8_CFG4 Register (Address = 0x63) [Reset = 0x0]

CH8_CFG4 is shown in [Figure 8-157](#) and described in [Table 8-133](#).

Return to the [Table 8-52](#).

This register is configuration register 4 for channel 8.

Figure 8-157. CH8_CFG4 Register

| 7 | 6 | 5 | 4 | 3 | 2 | 1 | 0 |
|---------------|---|---|---|---|---|---|---|
| CH8_PCAL[7:0] | | | | | | | |
| R/W-00000000b | | | | | | | |

Table 8-133. CH8_CFG4 Register Field Descriptions

| Bit | Field | Type | Reset | Description |
|-----|---------------|------|-----------|---|
| 7-0 | CH8_PCAL[7:0] | R/W | 00000000b | Channel-8 Phase Calibration with modulator clock resolution. 0d = Phase Calibration with 0-cycle of modulator clock delay 1d = Phase Calibration with 1-cycles of modulator clock delay 2d = Phase Calibration with 1-cycles of modulator clock delay 3d to 254d = Delay Value is as per configuration 255d = Phase Calibration with 255-cycles of modulator clock delay |

8.6.1.2.82 DIAG_CFG0 Register (Address = 0x64) [Reset = 0x0]

DIAG_CFG0 is shown in [Figure 8-158](#) and described in [Table 8-134](#).

Return to the [Table 8-52](#).

This register is configuration register 0 for input fault diagnostics setting.

Figure 8-158. DIAG_CFG0 Register

| 7 | 6 | 5 | 4 | 3 | 2 | 1 | 0 |
|-------------|-------------|-------------|-------------|----------|----------|-------------|------------------|
| CH1_DIAG_EN | CH2_DIAG_EN | CH3_DIAG_EN | CH4_DIAG_EN | RESERVED | RESERVED | INCL_SE_INM | INCL_AC_COU P |
| R/W-0b | R/W-0b | R/W-0b | R/W-0b | R/W-0b | R/W-0b | R/W-0b | R/W-0b |

Table 8-134. DIAG_CFG0 Register Field Descriptions

| Bit | Field | Type | Reset | Description |
|-----|-------------|------|-------|--|
| 7 | CH1_DIAG_EN | R/W | 0b | Channel 1 input (IN1P and IN1M) scan for diagnostics. 0d = Diagnostic disabled 1d = Diagnostic enabled |
| 6 | CH2_DIAG_EN | R/W | 0b | Channel 2 input (IN2P and IN2M) scan for diagnostics. 0d = Diagnostic disabled 1d = Diagnostic enabled |

Table 8-134. DIAG_CFG0 Register Field Descriptions (continued)

| Bit | Field | Type | Reset | Description |
|-----|--------------|------|-------|--|
| 5 | CH3_DIAG_EN | R/W | 0b | Channel 3 input (IN3P and IN3M) scan for diagnostics. 0d = Diagnostic disabled 1d = Diagnostic enabled |
| 4 | CH4_DIAG_EN | R/W | 0b | Channel 4 input (IN4P and IN4M) scan for diagnostics. 0d = Diagnostic disabled 1d = Diagnostic enabled |
| 3 | RESERVED | R/W | 0b | Reserved bit; Write only reset value |
| 2 | RESERVED | R/W | 0b | Reserved bit; Write only reset value |
| 1 | INCL_SE_INM | R/W | 0b | INxM pin diagnostics scan selection for single-ended configuration. 0d = INxM pins of single-ended channels are excluded for diagnosis 1d = INxM pins of single-ended channels are included for diagnosis |
| 0 | INCL_AC_COUP | R/W | 0b | AC-coupled channels pins scan selection for diagnostics. 0d = INxP and INxM pins of AC-coupled channels are excluded for diagnosis 1d = INxP and INxM pins of AC-coupled channels are included for diagnosis |

8.6.1.2.83 DIAG_CFG1 Register (Address = 0x65) [Reset = 0x37]

DIAG_CFG1 is shown in [Figure 8-159](#) and described in [Table 8-135](#).

Return to the [Table 8-52](#).

This register is configuration register 1 for input fault diagnostics setting.

Figure 8-159. DIAG_CFG1 Register

| 7 | 6 | 5 | 4 | 3 | 2 | 1 | 0 |
|--------------------|---|---|---|-----------------------|---|---|---|
| DIAG_SHT_TERM[3:0] | | | | DIAG_SHT_VBAT_IN[3:0] | | | |
| R/W-0011b | | | | R/W-0111b | | | |

Table 8-135. DIAG_CFG1 Register Field Descriptions

| Bit | Field | Type | Reset | Description |
|-----|-----------------------|------|-------|--|
| 7-4 | DIAG_SHT_TERM[3:0] | R/W | 0011b | INxP and INxM terminal short detect threshold. 0d = INxP and INxM terminal short detect threshold value is 0 mV (typ) 1d = INxP and INxM terminal short detect threshold value is 30 mV (typ) 2d = INxP and INxM terminal short detect threshold value is 60 mV (typ) 10d to 13d = INxP and INxM terminal short detect threshold value is set as per configuration 14d = INxP and INxM terminal short detect threshold value is 420 mV (typ) 15d = INxP and INxM terminal short detect threshold value is 450 mV (typ) |
| 3-0 | DIAG_SHT_VBAT_IN[3:0] | R/W | 0111b | Short to VBAT_IN detect threshold. 0d = Short to VBAT_IN detect threshold value is 0 mV (typ) 1d = Short to VBAT_IN detect threshold value is 30 mV (typ) 2d = Short to VBAT_IN detect threshold value is 60 mV (typ) 10d to 13d = Short to VBAT_IN detect threshold value is set as per configuration 14d = Short to VBAT_IN detect threshold value is 420 mV (typ) 15d = Short to VBAT_IN detect threshold value is 450 mV (typ) |

8.6.1.2.84 DIAG_CFG2 Register (Address = 0x66) [Reset = 0x87]

DIAG_CFG2 is shown in [Figure 8-160](#) and described in [Table 8-136](#).

Return to the [Table 8-52](#).

This register is configuration register 2 for input fault diagnostics setting.

Figure 8-160. DIAG_CFG2 Register

| 7 | 6 | 5 | 4 | 3 | 2 | 1 | 0 |
|-------------------|---|---|---|-----------------------|---|---|---|
| DIAG_SHT_GND[3:0] | | | | DIAG_SHT_MICBIAS[3:0] | | | |
| R/W-1000b | | | | R/W-0111b | | | |

Table 8-136. DIAG_CFG2 Register Field Descriptions

| Bit | Field | Type | Reset | Description |
|-----|-----------------------|------|-------|--|
| 7-4 | DIAG_SHT_GND[3:0] | R/W | 1000b | Short to ground detect threshold. 0d = Short to ground detect threshold value is 0 mV (typ) 1d = Short to ground detect threshold value is 60 mV (typ) 2d = Short to ground detect threshold value is 120 mV (typ) 10d to 13d = Short to ground detect threshold value is set as per configuration 14d = Short to ground detect threshold value is 840 mV (typ) 15d = Short to ground detect threshold value is 900 mV (typ) |
| 3-0 | DIAG_SHT_MICBIAS[3:0] | R/W | 0111b | Short to MICBIAS detect threshold. 0d = Short to MICBIAS detect threshold value is 0 mV (typ) 1d = Short to MICBIAS detect threshold value is 30 mV (typ) 2d = Short to MICBIAS detect threshold value is 60 mV (typ) 10d to 13d = Short to MICBIAS detect threshold value is set as per configuration 14d = Short to MICBIAS detect threshold value is 420 mV (typ) 15d = Short to MICBIAS detect threshold value is 450 mV (typ) |

8.6.1.2.85 DIAG_CFG3 Register (Address = 0x67) [Reset = 0xB8]

DIAG_CFG3 is shown in [Figure 8-161](#) and described in [Table 8-137](#).

Return to the [Table 8-52](#).

This register is configuration register 3 for input fault diagnostics setting.

Figure 8-161. DIAG_CFG3 Register

| 7 | 6 | 5 | 4 | 3 | 2 | 1 | 0 |
|---------------|---|----------|---|----------------------|---|------------------|-------------------|
| REP_RATE[1:0] | | RESERVED | | FAULT_DBNCE_SEL[1:0] | | VSHORT_DBN CE | DIAG_2X_THR ES |
| R/W-10b | | R/W-11b | | R/W-10b | | R/W-0b | R/W-0b |

Table 8-137. DIAG_CFG3 Register Field Descriptions

| Bit | Field | Type | Reset | Description |
|-----|----------------------|------|-------|--|
| 7-6 | REP_RATE[1:0] | R/W | 10b | Fault monitoring scan repetition rate. 0d = Continuous back to back scanning of selected channels input pins without any idle time 1d = Fault monitoring repetition rate of 1 ms for selected channels input pins scanning 2d = Fault monitoring repetition rate of 4 ms for selected channels input pins scanning 3d = Fault monitoring repetition rate of 8 ms for selected channels input pins scanning |
| 5-4 | RESERVED | R/W | 11b | Reserved bits; Write only reset values |
| 3-2 | FAULT_DBNCE_SEL[1:0] | R/W | 10b | Debounce count for all the faults (except VBAT_IN short when VBAT_IN < MICBIAS). 0d = 16 counts for debounce to filter-out any false faults detection 1d = 8 counts for debounce to filter-out any false faults detection 2d = 4 counts for debounce to filter-out any false faults detection 3d = No debounce count |

Table 8-137. DIAG_CFG3 Register Field Descriptions (continued)

| Bit | Field | Type | Reset | Description |
|-----|---------------|------|-------|--|
| 1 | VSHORT_DBNCE | R/W | 0b | VBAT_IN short debounce count only when VBAT_IN < MICBIAS. 0d = 16 counts for debounce to filter-out any false faults detection 1d = 8 counts for debounce to filter-out any false faults detection |
| 0 | DIAG_2X_THRES | R/W | 0b | Diagnostic thresholds range scale. 0d = Thresholds same as configured in P0_R101 and P0_R102 1d = All the configuration thresholds gets scale by 2 times |

8.6.1.2.86 DIAG_CFG4 Register (Address = 0x68) [Reset = 0x0]

DIAG_CFG4 is shown in [Figure 8-162](#) and described in [Table 8-138](#).

Return to the [Table 8-52](#).

This register is configuration register 4 for input fault diagnostics setting.

Figure 8-162. DIAG_CFG4 Register

| 7 | 6 | 5 | 4 | 3 | 2 | 1 | 0 |
|-----------------------|---|------------------------|-----------------------|----------|---|---|---|
| DIAG_MOV_AVG_CFG[1:0] | | MOV_AVG_DIS_MBIAS_LOAD | MOV_AVG_DIS_TEMP_SENS | RESERVED | | | |
| R/W-00b | | R/W-0b | R/W-0b | R-0000b | | | |

Table 8-138. DIAG_CFG4 Register Field Descriptions

| Bit | Field | Type | Reset | Description |
|-----|------------------------|------|-------|--|
| 7-6 | DIAG_MOV_AVG_CFG[1:0] | R/W | 00b | Moving average configuration. 0d = Moving average disabled 1d = Moving average enabled with 0.5 weightage for old scanned data and new scanned data 2d = Moving average enabled with 0.75 weightage for old scanned data and 0.25 weightage for new scanned data 3d = Reserved |
| 5 | MOV_AVG_DIS_MBIAS_LOAD | R/W | 0b | Moving average configuration for MICBIAS high and low load current fault detection 0d = Moving average as defined by DIAG_MOV_AVG_CFG setting 1d = Moving average is forced disabled for MICBIAS load current fault detection to achieve faster response time |
| 4 | MOV_AVG_DIS_TEMP_SENS | R/W | 0b | Moving average configuration for over temperature fault detection 0d = Moving average as defined by DIAG_MOV_AVG_CFG setting 1d = Moving average is forced disabled for over temperature fault detection to achieve faster response time |
| 3-0 | RESERVED | R | 0000b | Reserved bits; Write only reset values |

8.6.1.2.87 BOOST_CFG Register (Address = 0x6A) [Reset = 0x0]

BOOST_CFG is shown in [Figure 8-163](#) and described in [Table 8-139](#).

Return to the [Table 8-52](#).

This register is configuration register for boost setting.

Figure 8-163. BOOST_CFG Register

| 7 | 6 | 5 | 4 | 3 | 2 | 1 | 0 |
|-----------|----------|----------|----------|----------|----------|---|---|
| BOOST_DIS | RESERVED | RESERVED | RESERVED | RESERVED | RESERVED | | |
| R/W-0b | R/W-0b | R/W-0b | R/W-0b | R/W-0b | R-000b | | |

Table 8-139. BOOST_CFG Register Field Descriptions

| Bit | Field | Type | Reset | Description |
|-----|-----------|------|-------|--|
| 7 | BOOST_DIS | R/W | 0b | Boost Enable/Disable 0d = Boost is enable 1d = Boost is disable/bypass |
| 6 | RESERVED | R/W | 0b | Reserved bit; Write only reset value |
| 5 | RESERVED | R/W | 0b | Reserved bit; Write only reset value |
| 4 | RESERVED | R/W | 0b | Reserved bit; Write only reset value |
| 3 | RESERVED | R/W | 0b | Reserved bit; Write only reset value |
| 2-0 | RESERVED | R | 000b | Reserved bits; Write only reset values |

8.6.1.2.88 DSP_CFG0 Register (Address = 0x6B) [Reset = 0x1]

DSP_CFG0 is shown in [Figure 8-164](#) and described in [Table 8-140](#).

Return to the [Table 8-52](#).

This register is the digital signal processor (DSP) configuration register 0.

Figure 8-164. DSP_CFG0 Register

| 7 | 6 | 5 | 4 | 3 | 2 | 1 | 0 |
|----------|---|----------------|---|-------------|---|--------------|---|
| RESERVED | | DECI_FILT[1:0] | | CH_SUM[1:0] | | HPF_SEL[1:0] | |
| R-00b | | R/W-00b | | R/W-00b | | R/W-01b | |

Table 8-140. DSP_CFG0 Register Field Descriptions

| Bit | Field | Type | Reset | Description |
|-----|----------------|------|-------|--|
| 7-6 | RESERVED | R | 00b | Reserved bits; Write only reset value |
| 5-4 | DECI_FILT[1:0] | R/W | 00b | Decimation filter response. 0d = Linear phase 1d = Low latency 2d = Ultra-low latency Dont use |
| 3-2 | CH_SUM[1:0] | R/W | 00b | Channel summation mode for higher SNR 0d = Channel summation mode is disabled 1d = 2-channel summation mode is enabled to generate a (CH1 + CH2) / 2 and a (CH3 + CH4) / 2 output 2d = 4-channel summation mode is enabled to generate a (CH1 + CH2 + CH3 + CH4) / 4 output 3d = Reserved |
| 1-0 | HPF_SEL[1:0] | R/W | 01b | High-pass filter (HPF) selection. 0d = Programmable first-order IIR filter for a custom HPF with default coefficient values in P4_R72 to P4_R83 set as the all-pass filter 1d = HPF with a cutoff of $0.00025 \times f_S$ (12 Hz at $f_S = 48$ kHz) is selected 2d = HPF with a cutoff of $0.002 \times f_S$ (96 Hz at $f_S = 48$ kHz) is selected 3d = HPF with a cutoff of $0.008 \times f_S$ (384 Hz at $f_S = 48$ kHz) is selected |

8.6.1.2.89 DSP_CFG1 Register (Address = 0x6C) [Reset = 0x48]

DSP_CFG1 is shown in [Figure 8-165](#) and described in [Table 8-141](#).

Return to the [Table 8-52](#).

This register is the digital signal processor (DSP) configuration register 1.

Figure 8-165. DSP_CFG1 Register

| 7 | 6 | 5 | 4 | 3 | 2 | 1 | 0 |
|---|---|---|---|---|---|---|---|
|---|---|---|---|---|---|---|---|

Figure 8-165. DSP_CFG1 Register (continued)

| | | | | | |
|-----------|-----------------|-----------------------|---------|----------|----------|
| DVOL_GANG | BIQUAD_CFG[1:0] | DISABLE_SOF T_STEP | AGC_SEL | RESERVED | RESERVED |
| R/W-0b | R/W-10b | R/W-0b | R/W-1b | R/W-0b | R-00b |

Table 8-141. DSP_CFG1 Register Field Descriptions

| Bit | Field | Type | Reset | Description |
|-----|-------------------|------|-------|--|
| 7 | DVOL_GANG | R/W | 0b | DVOL control ganged across channels. 0d = Each channel has its own DVOL CTRL settings as programmed in the CHx_DVOL bits 1d = All active channels must use the channel 1 DVOL setting (CH1_DVOL) irrespective of whether channel 1 is turned on or not |
| 6-5 | BIQUAD_CFG[1:0] | R/W | 10b | Number of biquads per channel configuration. 0d = No biquads per channel; biquads are all disabled 1d = 1 biquad per channel 2d = 2 biquads per channel 3d = 3 biquads per channel |
| 4 | DISABLE_SOFT_STEP | R/W | 0b | Soft-stepping disable during DVOL change, mute, and unmute. 0d = Soft-stepping enabled 1d = Soft-stepping disabled |
| 3 | AGC_SEL | R/W | 1b | AGC master enable setting. 0d = Reserved; Write always 1 to this register bit 1d = AGC selected as configured for each channel using CHx_CFG0 register |
| 2 | RESERVED | R/W | 0b | Reserved bit; Write only reset value |
| 1-0 | RESERVED | R | 00b | Reserved bits; Write only reset value |

8.6.1.2.90 AGC_CFG0 Register (Address = 0x70) [Reset = 0xE7]

AGC_CFG0 is shown in [Figure 8-166](#) and described in [Table 8-142](#).

Return to the [Table 8-52](#).

This register is the automatic gain controller (AGC) configuration register 0.

Figure 8-166. AGC_CFG0 Register

| | | | | | | | |
|--------------|---|---|---|------------------|---|---|---|
| 7 | 6 | 5 | 4 | 3 | 2 | 1 | 0 |
| AGC_LVL[3:0] | | | | AGC_MAXGAIN[3:0] | | | |
| R/W-1110b | | | | R/W-0111b | | | |

Table 8-142. AGC_CFG0 Register Field Descriptions

| Bit | Field | Type | Reset | Description |
|-----|------------------|------|-------|--|
| 7-4 | AGC_LVL[3:0] | R/W | 1110b | AGC output signal target level. 0d = Output signal target level is -6 dB 1d = Output signal target level is -8 dB 2d = Output signal target level is -10 dB 3d to 13d = Output signal target level is as per configuration 14d = Output signal target level is -34 dB 15d = Output signal target level is -36 dB |
| 3-0 | AGC_MAXGAIN[3:0] | R/W | 0111b | AGC maximum gain allowed. 0d = Maximum gain allowed is 3 dB 1d = Maximum gain allowed is 6 dB 2d = Maximum gain allowed is 9 dB 3d to 11d = Maximum gain allowed is as per configuration 12d = Maximum gain allowed is 39 dB 13d = Maximum gain allowed is 42 dB 14d to 15d = Reserved |

8.6.1.2.91 IN_CH_EN Register (Address = 0x73) [Reset = 0xFC]

IN_CH_EN is shown in [Figure 8-167](#) and described in [Table 8-143](#).

Return to the [Table 8-52](#).

This register is the input channel enable configuration register.

Figure 8-167. IN_CH_EN Register

| 7 | 6 | 5 | 4 | 3 | 2 | 1 | 0 |
|-----------|-----------|-----------|-----------|-----------|-----------|-----------|-----------|
| IN_CH1_EN | IN_CH2_EN | IN_CH3_EN | IN_CH4_EN | IN_CH5_EN | IN_CH6_EN | IN_CH7_EN | IN_CH8_EN |
| R/W-1b | R/W-1b | R/W-1b | R/W-1b | R/W-1b | R/W-1b | R/W-0b | R/W-0b |

Table 8-143. IN_CH_EN Register Field Descriptions

| Bit | Field | Type | Reset | Description |
|-----|-----------|------|-------|---|
| 7 | IN_CH1_EN | R/W | 1b | Input channel 1 enable setting. 0d = Channel 1 is disabled 1d = Channel 1 is enabled |
| 6 | IN_CH2_EN | R/W | 1b | Input channel 2 enable setting. 0d = Channel 2 is disabled 1d = Channel 2 is enabled |
| 5 | IN_CH3_EN | R/W | 1b | Input channel 3 enable setting. 0d = Channel 3 is disabled 1d = Channel 3 is enabled |
| 4 | IN_CH4_EN | R/W | 1b | Input channel 4 enable setting. 0d = Channel 4 is disabled 1d = Channel 4 is enabled |
| 3 | IN_CH5_EN | R/W | 1b | Input channel 5 (PDM only) enable setting. 0d = Channel 5 is disabled 1d = Channel 5 is enabled |
| 2 | IN_CH6_EN | R/W | 1b | Input channel 6 (PDM only) enable setting. 0d = Channel 6 is disabled 1d = Channel 6 is enabled |
| 1 | IN_CH7_EN | R/W | 0b | Input channel 7 (PDM only) enable setting. 0d = Channel 7 is disabled 1d = Channel 7 is enabled |
| 0 | IN_CH8_EN | R/W | 0b | Input channel 8 (PDM only) enable setting. 0d = Channel 8 is disabled 1d = Channel 8 is enabled |

8.6.1.2.92 ASI_OUT_CH_EN Register (Address = 0x74) [Reset = 0x0]

ASI_OUT_CH_EN is shown in [Figure 8-168](#) and described in [Table 8-144](#).

Return to the [Table 8-52](#).

This register is the ASI output channel enable configuration register.

Figure 8-168. ASI_OUT_CH_EN Register

| 7 | 6 | 5 | 4 | 3 | 2 | 1 | 0 |
|----------------|----------------|----------------|----------------|----------------|----------------|----------------|----------------|
| ASI_OUT_CH1_EN | ASI_OUT_CH2_EN | ASI_OUT_CH3_EN | ASI_OUT_CH4_EN | ASI_OUT_CH5_EN | ASI_OUT_CH6_EN | ASI_OUT_CH7_EN | ASI_OUT_CH8_EN |
| R/W-0b | R/W-0b | R/W-0b | R/W-0b | R/W-0b | R/W-0b | R/W-0b | R/W-0b |

Table 8-144. ASI_OUT_CH_EN Register Field Descriptions

| Bit | Field | Type | Reset | Description |
|-----|----------------|------|-------|---|
| 7 | ASI_OUT_CH1_EN | R/W | 0b | ASI output channel 1 enable setting. 0d = Channel 1 output slot is in a tri-state condition 1d = Channel 1 output slot is enabled |

Table 8-144. ASI_OUT_CH_EN Register Field Descriptions (continued)

| Bit | Field | Type | Reset | Description |
|-----|----------------|------|-------|---|
| 6 | ASI_OUT_CH2_EN | R/W | 0b | ASI output channel 2 enable setting. 0d = Channel 2 output slot is in a tri-state condition 1d = Channel 2 output slot is enabled |
| 5 | ASI_OUT_CH3_EN | R/W | 0b | ASI output channel 3 enable setting. 0d = Channel 3 output slot is in a tri-state condition 1d = Channel 3 output slot is enabled |
| 4 | ASI_OUT_CH4_EN | R/W | 0b | ASI output channel 4 enable setting. 0d = Channel 4 output slot is in a tri-state condition 1d = Channel 4 output slot is enabled |
| 3 | ASI_OUT_CH5_EN | R/W | 0b | ASI output channel 5 enable setting. 0d = Channel 5 output slot is in a tri-state condition 1d = Channel 5 output slot is enabled |
| 2 | ASI_OUT_CH6_EN | R/W | 0b | ASI output channel 6 enable setting. 0d = Channel 6 output slot is in a tri-state condition 1d = Channel 6 output slot is enabled |
| 1 | ASI_OUT_CH7_EN | R/W | 0b | ASI output channel 7 enable setting. 0d = Channel 7 output slot is in a tri-state condition 1d = Channel 7 output slot is enabled |
| 0 | ASI_OUT_CH8_EN | R/W | 0b | ASI output channel 8 enable setting. 0d = Channel 8 output slot is in a tri-state condition 1d = Channel 8 output slot is enabled |

8.6.1.2.93 PWR_CFG Register (Address = 0x75) [Reset = 0x0]

PWR_CFG is shown in [Figure 8-169](#) and described in [Table 8-145](#).

Return to the [Table 8-52](#).

This register is the power-up configuration register.

Figure 8-169. PWR_CFG Register

| 7 | 6 | 5 | 4 | 3 | 2 | 1 | 0 |
|-------------|---------|---------|----------------|--------------------|---|----------|----------|
| MICBIAS_PDZ | ADC_PDZ | PLL_PDZ | DYN_CH_PUPD_EN | DYN_MAXCH_SEL[1:0] | | RESERVED | RESERVED |
| R/W-0b | R/W-0b | R/W-0b | R/W-0b | R/W-00b | | R/W-0b | R-0b |

Table 8-145. PWR_CFG Register Field Descriptions

| Bit | Field | Type | Reset | Description |
|-----|----------------|------|-------|--|
| 7 | MICBIAS_PDZ | R/W | 0b | Power control for MICBIAS. 0d = Power down MICBIAS 1d = Power up MICBIAS |
| 6 | ADC_PDZ | R/W | 0b | Power control for ADC and PDM channels. 0d = Power down all ADC and PDM channels 1d = Power up all enabled ADC and PDM channels |
| 5 | PLL_PDZ | R/W | 0b | Power control for the PLL. 0d = Power down the PLL 1d = Power up the PLL |
| 4 | DYN_CH_PUPD_EN | R/W | 0b | Dynamic channel power-up, power-down enable. 0d = Channel power-up, power-down is not supported if any channel recording is on 1d = Channel can be powered up or down individually, even if channel recording is on. Do not powered-down channel 1 if this bit is set to '1' |

Table 8-145. PWR_CFG Register Field Descriptions (continued)

| Bit | Field | Type | Reset | Description |
|-----|--------------------|------|-------|---|
| 3-2 | DYN_MAXCH_SEL[1:0] | R/W | 00b | Dynamic mode maximum channel select configuration. 0d = Channel 1 and channel 2 are used with dynamic channel power-up, power-down feature enabled 1d = Channel 1 to channel 4 are used with dynamic channel power-up, power-down feature enabled 2d = Channel 1 to channel 6 are used with dynamic channel power-up, power-down feature enabled 3d = Channel 1 to channel 8 are used with dynamic channel power-up, power-down feature enabled |
| 1 | RESERVED | R/W | 0b | Reserved bit; Write only reset value |
| 0 | RESERVED | R | 0b | Reserved bit; Write only reset value |

8.6.1.2.94 DEV_STS0 Register (Address = 0x76) [Reset = 0x0]

DEV_STS0 is shown in [Figure 8-170](#) and described in [Table 8-146](#).

Return to the [Table 8-52](#).

This register is the device status value register 0.

Figure 8-170. DEV_STS0 Register

| 7 | 6 | 5 | 4 | 3 | 2 | 1 | 0 |
|------------|------------|------------|------------|------------|------------|------------|------------|
| CH1_STATUS | CH2_STATUS | CH3_STATUS | CH4_STATUS | CH5_STATUS | CH6_STATUS | CH7_STATUS | CH8_STATUS |
| R-0b | R-0b | R-0b | R-0b | R-0b | R-0b | R-0b | R-0b |

Table 8-146. DEV_STS0 Register Field Descriptions

| Bit | Field | Type | Reset | Description |
|-----|------------|------|-------|---|
| 7 | CH1_STATUS | R | 0b | ADC channel 1 power status. 0d = ADC channel is powered down 1d = ADC channel is powered up |
| 6 | CH2_STATUS | R | 0b | ADC channel 2 power status. 0d = ADC channel is powered down 1d = ADC channel is powered up |
| 5 | CH3_STATUS | R | 0b | ADC channel 3 power status. 0d = ADC channel is powered down 1d = ADC channel is powered up |
| 4 | CH4_STATUS | R | 0b | ADC channel 4 power status. 0d = ADC channel is powered down 1d = ADC channel is powered up |
| 3 | CH5_STATUS | R | 0b | ADC channel 5 power status. 0d = ADC channel is powered down 1d = ADC channel is powered up |
| 2 | CH6_STATUS | R | 0b | ADC channel 6 power status. 0d = ADC channel is powered down 1d = ADC channel is powered up |
| 1 | CH7_STATUS | R | 0b | PDM channel 7 power status. 0d = PDM channel is powered down 1d = PDM channel is powered up |
| 0 | CH8_STATUS | R | 0b | PDM channel 8 power status. 0d = PDM channel is powered down 1d = PDM channel is powered up |

8.6.1.2.95 DEV_STS1 Register (Address = 0x77) [Reset = 0x80]

DEV_STS1 is shown in [Figure 8-171](#) and described in [Table 8-147](#).

Return to the [Table 8-52](#).

This register is the device status value register 1.

Figure 8-171. DEV_STS1 Register

| 7 | 6 | 5 | 4 | 3 | 2 | 1 | 0 |
|---------------|---|-----------|---|-----------|----------------|--------------------|--------------------|
| MODE_STS[2:0] | | BOOST_STS | | MBIAS_STS | CHx_PD_FLT_STS | ALL_CHx_PD_FLT_STS | MAN_RCV_PD_FLT_CHK |
| R-100b | | R-0b | | R-0b | R-0b | R-0b | R/W-0b |

Table 8-147. DEV_STS1 Register Field Descriptions

| Bit | Field | Type | Reset | Description |
|-----|--------------------|------|-------|---|
| 7-5 | MODE_STS[2:0] | R | 100b | Device mode status. 4d = Device is in sleep mode or software shutdown mode 6d = Device is in active mode with all ADC or PDM channels turned off 7d = Device is in active mode with at least one ADC or PDM channel turned on |
| 4 | BOOST_STS | R | 0b | Boost power up status. 0d = Boost is powered down 1d = Boost is powered up |
| 3 | MBIAS_STS | R | 0b | MICBIAS power up status. 0d = MICBIAS is powered down 1d = MICBIAS is powered up |
| 2 | CHx_PD_FLT_STS | R | 0b | ADC channel power down status caused by INxx inputs faults. 0d = No ADC channel is powered down caused by INxx inputs faults 1d = Atleast a ADC channel is powered down caused by INxx inputs faults |
| 1 | ALL_CHx_PD_FLT_STS | R | 0b | ADC channel power down status caused by MICBIAS faults. 0d = No ADC channel is powered down caused by MICBIAS faults 1d = All ADC channels are powered down caused by MICBIAS faults |
| 0 | MAN_RCV_PD_FLT_CHK | R/W | 0b | Manual recovery (self-clearing bit). 0d = No effect 1d = Recheck all fault status and re-powerup ADC channels and/or MICBIAS if they do not have any faults. Before setting this bit, reset P0_R58 register and re-configure P0_R58 to desired setting only after manual recover gets over. |

8.6.1.2.96 I2C_CKSUM Register (Address = 0x7E) [Reset = 0x0]

I2C_CKSUM is shown in [Figure 8-172](#) and described in [Table 8-148](#).

Return to the [Table 8-52](#).

This register returns the I²C transactions checksum value

Figure 8-172. I2C_CKSUM Register

| 7 | 6 | 5 | 4 | 3 | 2 | 1 | 0 |
|----------------|---|---|---|---|---|---|---|
| I2C_CKSUM[7:0] | | | | | | | |
| R/W-0000000b | | | | | | | |

Table 8-148. I2C_CKSUM Register Field Descriptions

| Bit | Field | Type | Reset | Description |
|-----|----------------|------|----------|--|
| 7-0 | I2C_CKSUM[7:0] | R/W | 0000000b | These bits return the I ² C transactions checksum value. Writing to this register resets the checksum to the written value. This register is updated on writes to other registers on all pages. |

8.6.1.3 Page 1 Registers

Table 8-149 lists the memory-mapped registers for the Page 1 registers. All register offset addresses not listed in Table 8-149 should be considered as reserved locations and the register contents should not be modified.

Table 8-149. PAGE 1 Registers

| Address | Acronym | Register Name | Reset Value | Section |
|---------|--------------------|--|-------------|------------------------------------|
| 0x0 | PAGE_CFG | Device page register | 0x00 | Section 8.6.1.3.1 |
| 0x16 | MBIAS_LOAD | MICBIAS internal load sink configuration register | 0x00 | Section 8.6.1.3.2 |
| 0x2C | INT_LIVE0 | Live interrupt readback register 0 | 0x00 | Section 8.6.1.3.3 |
| 0x2D | CHx_LIVE | Channel diagnostic summary live status register | 0x00 | Section 8.6.1.3.4 |
| 0x2E | CH1_LIVE | Channel 1 diagnostic live status register | 0x00 | Section 8.6.1.3.5 |
| 0x2F | CH2_LIVE | Channel 2 diagnostic live status register | 0x00 | Section 8.6.1.3.6 |
| 0x30 | CH3_LIVE | Channel 3 diagnostic live status register | 0x00 | Section 8.6.1.3.7 |
| 0x31 | CH4_LIVE | Channel 4 diagnostic live status register | 0x00 | Section 8.6.1.3.8 |
| 0x35 | INT_LIVE1 | Live interrupt readback register 1 | 0x00 | Section 8.6.1.3.9 |
| 0x37 | INT_LIVE3 | Live interrupt readback register 3 | 0x00 | Section 8.6.1.3.10 |
| 0x55 | MBIAS_OV_CFG | MICBIAS overvoltage threshold register | 0x40 | Section 8.6.1.3.11 |
| 0x59 | DIAGDATA_CFG | Diagnostic data configuration register | 0x00 | Section 8.6.1.3.12 |
| 0x5A | DIAG_MON_MSB_VBAT | Diagnostic VBAT_IN data MSB byte register | 0x00 | Section 8.6.1.3.13 |
| 0x5B | DIAG_MON_LSB_VBAT | Diagnostic VBAT_IN data LSB nibble register | 0x00 | Section 8.6.1.3.14 |
| 0x5C | DIAG_MON_MSB_MBIAS | Diagnostic MICBIAS data MSB byte register | 0x00 | Section 8.6.1.3.15 |
| 0x5D | DIAG_MON_LSB_MBIAS | Diagnostic MICBIAS data LSB nibble register | 0x01 | Section 8.6.1.3.16 |
| 0x5E | DIAG_MON_MSB_IN1P | Diagnostic IN1P data MSB byte register | 0x00 | Section 8.6.1.3.17 |
| 0x5F | DIAG_MON_LSB_IN1P | Diagnostic IN1P data LSB nibble register | 0x02 | Section 8.6.1.3.18 |
| 0x60 | DIAG_MON_MSB_IN1M | Diagnostic IN1M data MSB byte register | 0x00 | Section 8.6.1.3.19 |
| 0x61 | DIAG_MON_LSB_IN1M | Diagnostic IN1M data LSB nibble register | 0x03 | Section 8.6.1.3.20 |
| 0x62 | DIAG_MON_MSB_IN2P | Diagnostic IN2P data MSB byte register | 0x00 | Section 8.6.1.3.21 |
| 0x63 | DIAG_MON_LSB_IN2P | Diagnostic IN2P data LSB nibble register | 0x04 | Section 8.6.1.3.22 |
| 0x64 | DIAG_MON_MSB_IN2M | Diagnostic IN2M data MSB byte register | 0x00 | Section 8.6.1.3.23 |
| 0x65 | DIAG_MON_LSB_IN2M | Diagnostic IN2M data LSB nibble register | 0x05 | Section 8.6.1.3.24 |
| 0x66 | DIAG_MON_MSB_IN3P | Diagnostic IN3P data MSB byte register | 0x00 | Section 8.6.1.3.25 |
| 0x67 | DIAG_MON_LSB_IN3P | Diagnostic IN3P data LSB nibble register | 0x06 | Section 8.6.1.3.26 |
| 0x68 | DIAG_MON_MSB_IN3M | Diagnostic IN3M data MSB byte register | 0x00 | Section 8.6.1.3.27 |
| 0x69 | DIAG_MON_LSB_IN3M | Diagnostic IN3M data LSB nibble register | 0x07 | Section 8.6.1.3.28 |
| 0x6A | DIAG_MON_MSB_IN4P | Diagnostic IN4P data MSB byte register | 0x00 | Section 8.6.1.3.29 |
| 0x6B | DIAG_MON_LSB_IN4P | Diagnostic IN4P data LSB nibble register | 0x08 | Section 8.6.1.3.30 |
| 0x6C | DIAG_MON_MSB_IN4M | Diagnostic IN4M data MSB byte register | 0x00 | Section 8.6.1.3.31 |
| 0x6D | DIAG_MON_LSB_IN4M | Diagnostic IN4M data LSB nibble register | 0x09 | Section 8.6.1.3.32 |
| 0x76 | DIAG_MON_MSB_TEMP | Diagnostic temperature data MSB byte register | 0x00 | Section 8.6.1.3.33 |
| 0x77 | DIAG_MON_LSB_TEMP | Diagnostic temperature data LSB nibble register | 0x0E | Section 8.6.1.3.34 |
| 0x78 | DIAG_MON_MSB_LOAD | Diagnostic MICBIAS load current data MSB byte register | 0x00 | Section 8.6.1.3.35 |
| 0x79 | DIAG_MON_LSB_LOAD | Diagnostic MICBIAS load current data LSB nibble register | 0x0F | Section 8.6.1.3.36 |
| 0x7E | REV_ID | Silicon revision ID register | 0x20 | Section 8.6.1.3.37 |

8.6.1.3.1 PAGE_CFG Register (Address = 0x0) [Reset = 0x0]

PAGE_CFG is shown in [Figure 8-173](#) and described in [Table 8-150](#).

Return to the [Table 8-149](#).

The device memory map is divided into pages. This register sets the page.

Figure 8-173. PAGE_CFG Register

| | | | | | | | |
|---------------|---|---|---|---|---|---|---|
| 7 | 6 | 5 | 4 | 3 | 2 | 1 | 0 |
| PAGE[7:0] | | | | | | | |
| R/W-00000000b | | | | | | | |

Table 8-150. PAGE_CFG Register Field Descriptions

| Bit | Field | Type | Reset | Description |
|-----|-----------|------|-----------|---|
| 7-0 | PAGE[7:0] | R/W | 00000000b | These bits set the device page. 0d = Page 0 1d = Page 1 ... 255d = Page 255 |

8.6.1.3.2 MBIAS_LOAD Register (Address = 0x16) [Reset = 0x0]

MBIAS_LOAD is shown in [Figure 8-174](#) and described in [Table 8-151](#).

Return to the [Table 8-149](#).

This register is the MICBIAS internal load sink configuration register.

Figure 8-174. MBIAS_LOAD Register

| | | | | | | | |
|--------------------------|--------------------------------|---|---|----------|---|---|---|
| 7 | 6 | 5 | 4 | 3 | 2 | 1 | 0 |
| MICBIAS_INT_LOAD_SINK_EN | MICBIAS_INT_LOAD_SINK_VAL[2:0] | | | RESERVED | | | |
| R/W-0b | R/W-000b | | | R-0000b | | | |

Table 8-151. MBIAS_LOAD Register Field Descriptions

| Bit | Field | Type | Reset | Description |
|-----|--------------------------------|------|-------|--|
| 7 | MICBIAS_INT_LOAD_SINK_EN | R/W | 0b | MICBIAS internal load sink setting. 0d = MICBIAS internal load sink is enabled with setting automatically calculated based on device configuration 1d = MICBIAS internal load sink is enabled based on D6-4 register bits; This setting must be used for single-ended AC-coupled input to support high signal swing |
| 6-4 | MICBIAS_INT_LOAD_SINK_VAL[2:0] | R/W | 000b | MICBIAS internal load sink current value. 0d = MICBIAS internal load sink current is set to 0 mA (typ) 1d = MICBIAS internal load sink current is set to 4.3 mA (typ) 2d = MICBIAS internal load sink current is set to 8.6 mA (typ) 3d = MICBIAS internal load sink current is set to 12.9 mA (typ) 4d = MICBIAS internal load sink current is set to 17.2 mA (typ) 5d = MICBIAS internal load sink current is set to 21.5 mA (typ) 6d = MICBIAS internal load sink current is set to 25.8 mA (typ) 7d = MICBIAS internal load sink current is set to 30.1 mA (typ) |
| 3-0 | RESERVED | R | 0000b | Reserved bits; Write only reset values |

8.6.1.3.3 INT_LIVE0 Register (Address = 0x2C) [Reset = 0x0]

INT_LIVE0 is shown in [Figure 8-175](#) and described in [Table 8-152](#).

Return to the [Table 8-149](#).

This register is the live Interrupt readback register 0.

Figure 8-175. INT_LIVE0 Register

| | | | | | | | |
|---|---|---|---|---|---|---|---|
| 7 | 6 | 5 | 4 | 3 | 2 | 1 | 0 |
|---|---|---|---|---|---|---|---|

Figure 8-175. INT_LIVE0 Register (continued)

| | | | | | | | |
|-----------|-----------|-----------|-----------|----------|----------|----------|----------|
| INT_LIVE0 | INT_LIVE0 | INT_LIVE0 | INT_LIVE0 | RESERVED | RESERVED | RESERVED | RESERVED |
| R-0b | R-0b | R-0b | R-0b | R-0b | R-0b | R-0b | R-0b |

Table 8-152. INT_LIVE0 Register Field Descriptions

| Bit | Field | Type | Reset | Description |
|-----|-----------|------|-------|--|
| 7 | INT_LIVE0 | R | 0b | Fault status for an ASI bus clock error. 0d = No fault detected 1d = Fault detected |
| 6 | INT_LIVE0 | R | 0b | Status of PLL lock. 0d = No PLL lock detected 1d = PLL lock detected |
| 5 | INT_LIVE0 | R | 0b | Fault status for boost or MICBIAS over temperature. 0d = No fault detected 1d = Fault detected |
| 4 | INT_LIVE0 | R | 0b | Fault status for boost or MICBIAS over current. 0d = No fault detected 1d = Fault detected |
| 3 | RESERVED | R | 0b | Reserved bit; Write only reset value |
| 2 | RESERVED | R | 0b | Reserved bit; Write only reset value |
| 1 | RESERVED | R | 0b | Reserved bit; Write only reset value |
| 0 | RESERVED | R | 0b | Reserved bit; Write only reset value |

8.6.1.3.4 CHx_LIVE Register (Address = 0x2D) [Reset = 0x0]

CHx_LIVE is shown in [Figure 8-176](#) and described in [Table 8-153](#).

Return to the [Table 8-149](#).

This register is the live Interrupt status register for channel level diagnostic summary.

Figure 8-176. CHx_LIVE Register

| | | | | | | | |
|--------------|--------------|--------------|--------------|----------|----------|--------------|----------|
| 7 | 6 | 5 | 4 | 3 | 2 | 1 | 0 |
| STS_CHx_LIVE | STS_CHx_LIVE | STS_CHx_LIVE | STS_CHx_LIVE | RESERVED | RESERVED | STS_CHx_LIVE | RESERVED |
| R-0b | R-0b | R-0b | R-0b | R-0b | R-0b | R-0b | R-0b |

Table 8-153. CHx_LIVE Register Field Descriptions

| Bit | Field | Type | Reset | Description |
|-----|--------------|------|-------|---|
| 7 | STS_CHx_LIVE | R | 0b | Status of CH1_LIVE. 0d = No faults occurred in channel 1 1d = Atleast a fault has occurred in channel 1 |
| 6 | STS_CHx_LIVE | R | 0b | Status of CH2_LIVE. 0d = No faults occurred in channel 2 1d = Atleast a fault has occurred in channel 2 |
| 5 | STS_CHx_LIVE | R | 0b | Status of CH3_LIVE. 0d = No faults occurred in channel 3 1d = Atleast a fault has occurred in channel 3 |
| 4 | STS_CHx_LIVE | R | 0b | Status of CH4_LIVE. 0d = No faults occurred in channel 4 1d = Atleast a fault has occurred in channel 4 |
| 3 | RESERVED | R | 0b | Reserved bit; Write only reset value |
| 2 | RESERVED | R | 0b | Reserved bit; Write only reset value |

Table 8-153. CHx_LIVE Register Field Descriptions (continued)

| Bit | Field | Type | Reset | Description |
|-----|--------------|------|-------|--|
| 1 | STS_CHx_LIVE | R | 0b | Status of short to VBAT_IN fault detected when VBAT_IN is less than MICBIAS. 0d = Short to VBAT_IN fault when VBAT_IN is less than MICBIAS has not occurred in any channel 1d = Short to VBAT_IN fault when VBAT_IN is less than MICBIAS has occurred in atleast one channel |
| 0 | RESERVED | R | 0b | Reserved bit; Write only reset value |

8.6.1.3.5 CH1_LIVE Register (Address = 0x2E) [Reset = 0x0]

CH1_LIVE is shown in [Figure 8-177](#) and described in [Table 8-154](#).

Return to the [Table 8-149](#).

This register is the live Interrupt status register for channel 1 fault diagnostic

Figure 8-177. CH1_LIVE Register

| 7 | 6 | 5 | 4 | 3 | 2 | 1 | 0 |
|----------|----------|----------|----------|----------|----------|----------|----------|
| CH1_LIVE | CH1_LIVE | CH1_LIVE | CH1_LIVE | CH1_LIVE | CH1_LIVE | CH1_LIVE | CH1_LIVE |
| R-0b | R-0b | R-0b | R-0b | R-0b | R-0b | R-0b | R-0b |

Table 8-154. CH1_LIVE Register Field Descriptions

| Bit | Field | Type | Reset | Description |
|-----|----------|------|-------|--|
| 7 | CH1_LIVE | R | 0b | Channel 1 open input fault status. 0d = No open input detected 1d = Open input detected |
| 6 | CH1_LIVE | R | 0b | Channel 1 input pair short fault status. 0d = No input pair short detected 1d = Input short to each other detected |
| 5 | CH1_LIVE | R | 0b | Channel 1 IN1P short to ground fault status. 0d = IN1P no short to ground detected 1d = IN1P short to ground detected |
| 4 | CH1_LIVE | R | 0b | Channel 1 IN1M short to ground fault status. 0d = IN1M no short to ground detected 1d = IN1M short to ground detected |
| 3 | CH1_LIVE | R | 0b | Channel 1 IN1P short to MICBIAS fault status. 0d = IN1P no short to MICBIAS detected 1d = IN1P short to MICBIAS detected |
| 2 | CH1_LIVE | R | 0b | Channel 1 IN1M short to MICBIAS fault status. 0d = IN1M no short to MICBIAS detected 1d = IN1M short to MICBIAS detected |
| 1 | CH1_LIVE | R | 0b | Channel 1 IN1P short to VBAT_IN fault status. 0d = IN1P no short to VBAT_IN detected 1d = IN1P short to VBAT_IN detected |
| 0 | CH1_LIVE | R | 0b | Channel 1 IN1M short to VBAT_IN fault status. 0d = IN1M no short to VBAT_IN detected 1d = IN1M short to VBAT_IN detected |

8.6.1.3.6 CH2_LIVE Register (Address = 0x2F) [Reset = 0x0]

CH2_LIVE is shown in [Figure 8-178](#) and described in [Table 8-155](#).

Return to the [Table 8-149](#).

This register is the live Interrupt status register for channel 2 fault diagnostic.

Figure 8-178. CH2_LIVE Register

| 7 | 6 | 5 | 4 | 3 | 2 | 1 | 0 |
|----------|----------|----------|----------|----------|----------|----------|----------|
| CH2_LIVE | CH2_LIVE | CH2_LIVE | CH2_LIVE | CH2_LIVE | CH2_LIVE | CH2_LIVE | CH2_LIVE |
| R-0b | R-0b | R-0b | R-0b | R-0b | R-0b | R-0b | R-0b |

Table 8-155. CH2_LIVE Register Field Descriptions

| Bit | Field | Type | Reset | Description |
|-----|----------|------|-------|--|
| 7 | CH2_LIVE | R | 0b | Channel 2 open input fault status. 0d = No open input detected 1d = Open input detected |
| 6 | CH2_LIVE | R | 0b | Channel 2 input pair short fault status. 0d = No input pair short detected 1d = Input short to each other detected |
| 5 | CH2_LIVE | R | 0b | Channel 2 IN2P short to ground fault status. 0d = IN2P no short to ground detected 1d = IN2P short to ground detected |
| 4 | CH2_LIVE | R | 0b | Channel 2 IN2M short to ground fault status. 0d = IN2M no short to ground detected 1d = IN2M short to ground detected |
| 3 | CH2_LIVE | R | 0b | Channel 2 IN2P short to MICBIAS fault status. 0d = IN2P no short to MICBIAS detected 1d = IN2P short to MICBIAS detected |
| 2 | CH2_LIVE | R | 0b | Channel 2 IN2M short to MICBIAS fault status. 0d = IN2M no short to MICBIAS detected 1d = IN2M short to MICBIAS detected |
| 1 | CH2_LIVE | R | 0b | Channel 2 IN2P short to VBAT_IN fault status. 0d = IN2P no short to VBAT_IN detected 1d = IN2P short to VBAT_IN detected |
| 0 | CH2_LIVE | R | 0b | Channel 2 IN2M short to VBAT_IN fault status. 0d = IN2M no short to VBAT_IN detected 1d = IN2M short to VBAT_IN detected |

8.6.1.3.7 CH3_LIVE Register (Address = 0x30) [Reset = 0x0]

CH3_LIVE is shown in [Figure 8-179](#) and described in [Table 8-156](#).

Return to the [Table 8-149](#).

This register is the live Interrupt status register for channel3 fault diagnostic

Figure 8-179. CH3_LIVE Register

| 7 | 6 | 5 | 4 | 3 | 2 | 1 | 0 |
|----------|----------|----------|----------|----------|----------|----------|----------|
| CH3_LIVE | CH3_LIVE | CH3_LIVE | CH3_LIVE | CH3_LIVE | CH3_LIVE | CH3_LIVE | CH3_LIVE |
| R-0b | R-0b | R-0b | R-0b | R-0b | R-0b | R-0b | R-0b |

Table 8-156. CH3_LIVE Register Field Descriptions

| Bit | Field | Type | Reset | Description |
|-----|----------|------|-------|---|
| 7 | CH3_LIVE | R | 0b | Channel 3 open input fault status. 0d = No open input detected 1d = Open input detected |
| 6 | CH3_LIVE | R | 0b | Channel 3 input pair short fault status. 0d = No input pair short detected 1d = Input short to each other detected |
| 5 | CH3_LIVE | R | 0b | Channel 3 IN3P short to ground fault status. 0d = IN3P no short to ground detected 1d = IN3P short to ground detected |

Table 8-156. CH3_LIVE Register Field Descriptions (continued)

| Bit | Field | Type | Reset | Description |
|-----|----------|------|-------|--|
| 4 | CH3_LIVE | R | 0b | Channel 3 IN3M short to ground fault status. 0d = IN3M no short to ground detected 1d = IN3M short to ground detected |
| 3 | CH3_LIVE | R | 0b | Channel 3 IN3P short to MICBIAS fault status. 0d = IN3P no short to MICBIAS detected 1d = IN3P short to MICBIAS detected |
| 2 | CH3_LIVE | R | 0b | Channel 3 IN3M short to MICBIAS fault status. 0d = IN3M no short to MICBIAS detected 1d = IN3M short to MICBIAS detected |
| 1 | CH3_LIVE | R | 0b | Channel 3 IN3P short to VBAT_IN fault status. 0d = IN3P no short to VBAT_IN detected 1d = IN3P short to VBAT_IN detected |
| 0 | CH3_LIVE | R | 0b | Channel 3 IN3M short to VBAT_IN fault status. 0d = IN3M no short to VBAT_IN detected 1d = IN3M short to VBAT_IN detected |

8.6.1.3.8 CH4_LIVE Register (Address = 0x31) [Reset = 0x0]

CH4_LIVE is shown in [Figure 8-180](#) and described in [Table 8-157](#).

Return to the [Table 8-149](#).

This register is the live Interrupt status register for channel 4 fault diagnostic.

Figure 8-180. CH4_LIVE Register

| 7 | 6 | 5 | 4 | 3 | 2 | 1 | 0 |
|----------|----------|----------|----------|----------|----------|----------|----------|
| CH4_LIVE | CH4_LIVE | CH4_LIVE | CH4_LIVE | CH4_LIVE | CH4_LIVE | CH4_LIVE | CH4_LIVE |
| R-0b | R-0b | R-0b | R-0b | R-0b | R-0b | R-0b | R-0b |

Table 8-157. CH4_LIVE Register Field Descriptions

| Bit | Field | Type | Reset | Description |
|-----|----------|------|-------|--|
| 7 | CH4_LIVE | R | 0b | Channel 4 open input fault status. 0d = No open input detected 1d = Open input detected |
| 6 | CH4_LIVE | R | 0b | Channel 4 input pair short fault status. 0d = No input pair short detected 1d = Input short to each other detected |
| 5 | CH4_LIVE | R | 0b | Channel 4 IN4P short to ground fault status. 0d = IN4P no short to ground detected 1d = IN4P short to ground detected |
| 4 | CH4_LIVE | R | 0b | Channel 4 IN4M short to ground fault status. 0d = IN4M no short to ground detected 1d = IN4M short to ground detected |
| 3 | CH4_LIVE | R | 0b | Channel 4 IN4P short to MICBIAS fault status. 0d = IN4P no short to MICBIAS detected 1d = IN4P short to MICBIAS detected |
| 2 | CH4_LIVE | R | 0b | Channel 4 IN4M short to MICBIAS fault status. 0d = IN4M no short to MICBIAS detected 1d = IN4M short to MICBIAS detected |
| 1 | CH4_LIVE | R | 0b | Channel 4 IN4P short to VBAT_IN fault status. 0d = IN4P no short to VBAT_IN detected 1d = IN4P short to VBAT_IN detected |
| 0 | CH4_LIVE | R | 0b | Channel 4 IN4M short to VBAT_IN fault status. 0d = IN4M no short to VBAT_IN detected 1d = IN4M short to VBAT_IN detected |

8.6.1.3.9 INT_LIVE1 Register (Address = 0x35) [Reset = 0x0]

INT_LIVE1 is shown in [Figure 8-181](#) and described in [Table 8-158](#).

Return to the [Table 8-149](#).

This register is the live Interrupt readback register 1.

Figure 8-181. INT_LIVE1 Register

| 7 | 6 | 5 | 4 | 3 | 2 | 1 | 0 |
|-----------|-----------|-----------|-----------|----------|----------|----------|---|
| INT_LIVE1 | INT_LIVE1 | INT_LIVE1 | INT_LIVE1 | RESERVED | RESERVED | RESERVED | |
| R-0b | R-0b | R-0b | R-0b | R-0b | R-0b | R-00b | |

Table 8-158. INT_LIVE1 Register Field Descriptions

| Bit | Field | Type | Reset | Description |
|-----|-----------|------|-------|--|
| 7 | INT_LIVE1 | R | 0b | Channel 1 IN1P over voltage fault status. 0d = No IN1P over voltage fault detected 1d = IN1P over voltage fault has detected |
| 6 | INT_LIVE1 | R | 0b | Channel 2 IN2P over voltage fault status. 0d = No IN2P over voltage fault detected 1d = IN2P over voltage fault has detected |
| 5 | INT_LIVE1 | R | 0b | Channel 3 IN3P over voltage fault status. 0d = No IN3P over voltage fault detected 1d = IN3P over voltage fault has detected |
| 4 | INT_LIVE1 | R | 0b | Channel 4 IN4P over voltage fault status. 0d = No IN4P over voltage fault detected 1d = IN4P over voltage fault has detected |
| 3 | RESERVED | R | 0b | Reserved bit; Write only reset value |
| 2 | RESERVED | R | 0b | Reserved bit; Write only reset value |
| 1-0 | RESERVED | R | 00b | Reserved bits; Write only reset value |

8.6.1.3.10 INT_LIVE3 Register (Address = 0x37) [Reset = 0x0]

INT_LIVE3 is shown in [Figure 8-182](#) and described in [Table 8-159](#).

Return to the [Table 8-149](#).

This register is the live Interrupt readback register 3.

Figure 8-182. INT_LIVE3 Register

| 7 | 6 | 5 | 4 | 3 | 2 | 1 | 0 |
|-----------|-----------|-----------|----------|---|---|---|---|
| INT_LIVE3 | INT_LIVE3 | INT_LIVE3 | RESERVED | | | | |
| R-0b | R-0b | R-0b | R-00000b | | | | |

Table 8-159. INT_LIVE3 Register Field Descriptions

| Bit | Field | Type | Reset | Description |
|-----|-----------|------|--------|---|
| 7 | INT_LIVE3 | R | 0b | Fault status for MICBIAS high current. 0d = No fault detected 1d = Fault detected |
| 6 | INT_LIVE3 | R | 0b | Fault status for MICBIAS low current. 0d = No fault detected 1d = Fault detected |
| 5 | INT_LIVE3 | R | 0b | Fault status for MICBIAS over voltage. 0d = No fault detected 1d = Fault detected |
| 4-0 | RESERVED | R | 00000b | Reserved bits; Write only reset value |

8.6.1.3.11 MBIAS_OV_CFG Register (Address = 0x55) [Reset = 0x40]

MBIAS_OV_CFG is shown in [Figure 8-183](#) and described in [Table 8-160](#).

Return to the [Table 8-149](#).

This register is the MICBIAS overvoltage configuration register.

Figure 8-183. MBIAS_OV_CFG Register

| | | | | | | | |
|---------------------|---|---|----------|---|---|---|---|
| 7 | 6 | 5 | 4 | 3 | 2 | 1 | 0 |
| MBIAS_OV_THRES[2:0] | | | RESERVED | | | | |
| R/W-010b | | | R-00000b | | | | |

Table 8-160. MBIAS_OV_CFG Register Field Descriptions

| Bit | Field | Type | Reset | Description |
|-----|---------------------|------|--------|---|
| 7-5 | MBIAS_OV_THRES[2:0] | R/W | 010b | MICBIAS overvoltage fault detection threshold above MICBIAS programmed voltage. 0d = No threshold over programmed voltage 1d = 10mV (typ) threshold over programmed voltage 2d = 40mV (typ) threshold over programmed voltage (default) 3d to 6d = Threshold value is set as per configuration with step size of 30mV (typ) 7d = 190mV (typ) threshold over programmed voltage (default) |
| 4-0 | RESERVED | R | 00000b | Reserved bits; Write only reset value |

8.6.1.3.12 DIAGDATA_CFG Register (Address = 0x59) [Reset = 0x0]

DIAGDATA_CFG is shown in [Figure 8-184](#) and described in [Table 8-161](#).

Return to the [Table 8-149](#).

This register is the diagnostic data configuration register.

Figure 8-184. DIAGDATA_CFG Register

| | | | | | | | |
|-----------|---|---|----------|---|---|---------------|---|
| 7 | 6 | 5 | 4 | 3 | 2 | 1 | 0 |
| RESERVED | | | RESERVED | | | HOLD_SAR_DATA | |
| R/W-0000b | | | R-000b | | | R/W-0b | |

Table 8-161. DIAGDATA_CFG Register Field Descriptions

| Bit | Field | Type | Reset | Description |
|-----|---------------|------|-------|---|
| 7-4 | RESERVED | R/W | 0000b | Reserved bits; Write only reset values |
| 3-1 | RESERVED | R | 000b | Reserved bits; Write only reset values |
| 0 | HOLD_SAR_DATA | R/W | 0b | Hold SAR data update during register readback. 0d = Data update is not held, data register is continuously updated; this setting must be used when moving average is enabled for fault detection 1d = Data update is held, data register readback can be done |

8.6.1.3.13 DIAG_MON_MSB_VBAT Register (Address = 0x5A) [Reset = 0x0]

DIAG_MON_MSB_VBAT is shown in [Figure 8-185](#) and described in [Table 8-162](#).

Return to the [Table 8-149](#).

This register is the MSB data byte of VBAT_IN monitoring.

Figure 8-185. DIAG_MON_MSB_VBAT Register

| | | | | | | | |
|---|---|---|---|---|---|---|---|
| 7 | 6 | 5 | 4 | 3 | 2 | 1 | 0 |
|---|---|---|---|---|---|---|---|

Figure 8-185. DIAG_MON_MSB_VBAT Register (continued)

| |
|------------------------|
| DIAG_MON_MSB_VBAT[7:0] |
| R-00000000b |

Table 8-162. DIAG_MON_MSB_VBAT Register Field Descriptions

| Bit | Field | Type | Reset | Description |
|-----|------------------------|------|-----------|---------------------------------------|
| 7-0 | DIAG_MON_MSB_VBAT[7:0] | R | 00000000b | Diagnostic SAR monitor data MSB byte. |

8.6.1.3.14 DIAG_MON_LSB_VBAT Register (Address = 0x5B) [Reset = 0x0]

DIAG_MON_LSB_VBAT is shown in [Figure 8-186](#) and described in [Table 8-163](#).

Return to the [Table 8-149](#).

This register is the LSB data nibble of VBAT_IN monitoring.

Figure 8-186. DIAG_MON_LSB_VBAT Register

| | | | | | | | |
|------------------------|---|---|---|-----------------|---|---|---|
| 7 | 6 | 5 | 4 | 3 | 2 | 1 | 0 |
| DIAG_MON_LSB_VBAT[3:0] | | | | CHANNEL_ID[3:0] | | | |
| R-0000b | | | | R-0000b | | | |

Table 8-163. DIAG_MON_LSB_VBAT Register Field Descriptions

| Bit | Field | Type | Reset | Description |
|-----|------------------------|------|-------|---|
| 7-4 | DIAG_MON_LSB_VBAT[3:0] | R | 0000b | Diagnostic SAR monitor data LSB nibble. |
| 3-0 | CHANNEL_ID[3:0] | R | 0000b | Channel ID value. |

8.6.1.3.15 DIAG_MON_MSB_MBIAS Register (Address = 0x5C) [Reset = 0x0]

DIAG_MON_MSB_MBIAS is shown in [Figure 8-187](#) and described in [Table 8-164](#).

Return to the [Table 8-149](#).

This register is the MSB data byte of MICBIAS monitoring.

Figure 8-187. DIAG_MON_MSB_MBIAS Register

| | | | | | | | |
|-------------------------|---|---|---|---|---|---|---|
| 7 | 6 | 5 | 4 | 3 | 2 | 1 | 0 |
| DIAG_MON_MSB_MBIAS[7:0] | | | | | | | |
| R-00000000b | | | | | | | |

Table 8-164. DIAG_MON_MSB_MBIAS Register Field Descriptions

| Bit | Field | Type | Reset | Description |
|-----|-------------------------|------|-----------|---------------------------------------|
| 7-0 | DIAG_MON_MSB_MBIAS[7:0] | R | 00000000b | Diagnostic SAR monitor data MSB byte. |

8.6.1.3.16 DIAG_MON_LSB_MBIAS Register (Address = 0x5D) [Reset = 0x1]

DIAG_MON_LSB_MBIAS is shown in [Figure 8-188](#) and described in [Table 8-165](#).

Return to the [Table 8-149](#).

This register is the LSB data nibble of MICBIAS monitoring.

Figure 8-188. DIAG_MON_LSB_MBIAS Register

| | | | | | | | |
|---|---|---|---|---|---|---|---|
| 7 | 6 | 5 | 4 | 3 | 2 | 1 | 0 |
|---|---|---|---|---|---|---|---|

Figure 8-188. DIAG_MON_LSB_MBIAS Register (continued)

| | |
|-------------------------|-----------------|
| DIAG_MON_LSB_MBIAS[3:0] | CHANNEL_ID[3:0] |
| R-0000b | R-0001b |

Table 8-165. DIAG_MON_LSB_MBIAS Register Field Descriptions

| Bit | Field | Type | Reset | Description |
|-----|-------------------------|------|-------|---|
| 7-4 | DIAG_MON_LSB_MBIAS[3:0] | R | 0000b | Diagnostic SAR monitor data LSB nibble. |
| 3-0 | CHANNEL_ID[3:0] | R | 0001b | Channel ID value. |

8.6.1.3.17 DIAG_MON_MSB_IN1P Register (Address = 0x5E) [Reset = 0x0]

DIAG_MON_MSB_IN1P is shown in [Figure 8-189](#) and described in [Table 8-166](#).

Return to the [Table 8-149](#).

This register is the MSB data byte of IN1P monitoring.

Figure 8-189. DIAG_MON_MSB_IN1P Register

| | | | | | | | |
|------------------------|---|---|---|---|---|---|---|
| 7 | 6 | 5 | 4 | 3 | 2 | 1 | 0 |
| DIAG_MON_MSB_CH1P[7:0] | | | | | | | |
| R-00000000b | | | | | | | |

Table 8-166. DIAG_MON_MSB_IN1P Register Field Descriptions

| Bit | Field | Type | Reset | Description |
|-----|------------------------|------|-----------|---------------------------------------|
| 7-0 | DIAG_MON_MSB_CH1P[7:0] | R | 00000000b | Diagnostic SAR monitor data MSB byte. |

8.6.1.3.18 DIAG_MON_LSB_IN1P Register (Address = 0x5F) [Reset = 0x2]

DIAG_MON_LSB_IN1P is shown in [Figure 8-190](#) and described in [Table 8-167](#).

Return to the [Table 8-149](#).

This register is the LSB data nibble of IN1P monitoring.

Figure 8-190. DIAG_MON_LSB_IN1P Register

| | | | | | | | |
|------------------------|---|---|---|-----------------|---|---|---|
| 7 | 6 | 5 | 4 | 3 | 2 | 1 | 0 |
| DIAG_MON_LSB_CH1P[3:0] | | | | CHANNEL_ID[3:0] | | | |
| R-0000b | | | | R-0010b | | | |

Table 8-167. DIAG_MON_LSB_IN1P Register Field Descriptions

| Bit | Field | Type | Reset | Description |
|-----|------------------------|------|-------|---|
| 7-4 | DIAG_MON_LSB_CH1P[3:0] | R | 0000b | Diagnostic SAR monitor data LSB nibble. |
| 3-0 | CHANNEL_ID[3:0] | R | 0010b | Channel ID value. |

8.6.1.3.19 DIAG_MON_MSB_IN1M Register (Address = 0x60) [Reset = 0x0]

DIAG_MON_MSB_IN1M is shown in [Figure 8-191](#) and described in [Table 8-168](#).

Return to the [Table 8-149](#).

This register is the MSB data byte of IN1M monitoring.

Figure 8-191. DIAG_MON_MSB_IN1M Register

| | | | | | | | |
|------------------------|---|---|---|---|---|---|---|
| 7 | 6 | 5 | 4 | 3 | 2 | 1 | 0 |
| DIAG_MON_MSB_CH1N[7:0] | | | | | | | |
| R-00000000b | | | | | | | |

Table 8-168. DIAG_MON_MSB_IN1M Register Field Descriptions

| Bit | Field | Type | Reset | Description |
|-----|------------------------|------|-----------|---------------------------------------|
| 7-0 | DIAG_MON_MSB_CH1N[7:0] | R | 00000000b | Diagnostic SAR monitor data MSB byte. |

8.6.1.3.20 DIAG_MON_LSB_IN1M Register (Address = 0x61) [Reset = 0x3]

DIAG_MON_LSB_IN1M is shown in [Figure 8-192](#) and described in [Table 8-169](#).

Return to the [Table 8-149](#).

This register is the LSB data nibble of IN1M monitoring.

Figure 8-192. DIAG_MON_LSB_IN1M Register

| | | | | | | | |
|------------------------|---|---|---|-----------------|---|---|---|
| 7 | 6 | 5 | 4 | 3 | 2 | 1 | 0 |
| DIAG_MON_LSB_CH1N[3:0] | | | | CHANNEL_ID[3:0] | | | |
| R-0000b | | | | R-0011b | | | |

Table 8-169. DIAG_MON_LSB_IN1M Register Field Descriptions

| Bit | Field | Type | Reset | Description |
|-----|------------------------|------|-------|---|
| 7-4 | DIAG_MON_LSB_CH1N[3:0] | R | 0000b | Diagnostic SAR monitor data LSB nibble. |
| 3-0 | CHANNEL_ID[3:0] | R | 0011b | Channel ID value. |

8.6.1.3.21 DIAG_MON_MSB_IN2P Register (Address = 0x62) [Reset = 0x0]

DIAG_MON_MSB_IN2P is shown in [Figure 8-193](#) and described in [Table 8-170](#).

Return to the [Table 8-149](#).

This register is the MSB data byte of IN2P monitoring.

Figure 8-193. DIAG_MON_MSB_IN2P Register

| | | | | | | | |
|------------------------|---|---|---|---|---|---|---|
| 7 | 6 | 5 | 4 | 3 | 2 | 1 | 0 |
| DIAG_MON_MSB_CH2P[7:0] | | | | | | | |
| R-00000000b | | | | | | | |

Table 8-170. DIAG_MON_MSB_IN2P Register Field Descriptions

| Bit | Field | Type | Reset | Description |
|-----|------------------------|------|-----------|---------------------------------------|
| 7-0 | DIAG_MON_MSB_CH2P[7:0] | R | 00000000b | Diagnostic SAR monitor data MSB byte. |

8.6.1.3.22 DIAG_MON_LSB_IN2P Register (Address = 0x63) [Reset = 0x4]

DIAG_MON_LSB_IN2P is shown in [Figure 8-194](#) and described in [Table 8-171](#).

Return to the [Table 8-149](#).

This register is the LSB data nibble of IN2P monitoring.

Figure 8-194. DIAG_MON_LSB_IN2P Register

| | | | | | | | |
|------------------------|---|---|---|-----------------|---|---|---|
| 7 | 6 | 5 | 4 | 3 | 2 | 1 | 0 |
| DIAG_MON_LSB_CH2P[3:0] | | | | CHANNEL_ID[3:0] | | | |
| R-0000b | | | | R-0100b | | | |

Table 8-171. DIAG_MON_LSB_IN2P Register Field Descriptions

| Bit | Field | Type | Reset | Description |
|-----|------------------------|------|-------|---|
| 7-4 | DIAG_MON_LSB_CH2P[3:0] | R | 0000b | Diagnostic SAR monitor data LSB nibble. |
| 3-0 | CHANNEL_ID[3:0] | R | 0100b | Channel ID value. |

8.6.1.3.23 DIAG_MON_MSB_IN2M Register (Address = 0x64) [Reset = 0x0]

DIAG_MON_MSB_IN2M is shown in [Figure 8-195](#) and described in [Table 8-172](#).

Return to the [Table 8-149](#).

This register is the MSB data byte of IN2M monitoring.

Figure 8-195. DIAG_MON_MSB_IN2M Register

| | | | | | | | |
|------------------------|---|---|---|---|---|---|---|
| 7 | 6 | 5 | 4 | 3 | 2 | 1 | 0 |
| DIAG_MON_MSB_CH2N[7:0] | | | | | | | |
| R-00000000b | | | | | | | |

Table 8-172. DIAG_MON_MSB_IN2M Register Field Descriptions

| Bit | Field | Type | Reset | Description |
|-----|------------------------|------|-----------|---------------------------------------|
| 7-0 | DIAG_MON_MSB_CH2N[7:0] | R | 00000000b | Diagnostic SAR monitor data MSB byte. |

8.6.1.3.24 DIAG_MON_LSB_IN2M Register (Address = 0x65) [Reset = 0x5]

DIAG_MON_LSB_IN2M is shown in [Figure 8-196](#) and described in [Table 8-173](#).

Return to the [Table 8-149](#).

This register is the LSB data nibble of IN2M monitoring.

Figure 8-196. DIAG_MON_LSB_IN2M Register

| | | | | | | | |
|------------------------|---|---|---|-----------------|---|---|---|
| 7 | 6 | 5 | 4 | 3 | 2 | 1 | 0 |
| DIAG_MON_LSB_CH2N[3:0] | | | | CHANNEL_ID[3:0] | | | |
| R-0000b | | | | R-0101b | | | |

Table 8-173. DIAG_MON_LSB_IN2M Register Field Descriptions

| Bit | Field | Type | Reset | Description |
|-----|------------------------|------|-------|---|
| 7-4 | DIAG_MON_LSB_CH2N[3:0] | R | 0000b | Diagnostic SAR monitor data LSB nibble. |
| 3-0 | CHANNEL_ID[3:0] | R | 0101b | Channel ID value. |

8.6.1.3.25 DIAG_MON_MSB_IN3P Register (Address = 0x66) [Reset = 0x0]

DIAG_MON_MSB_IN3P is shown in [Figure 8-197](#) and described in [Table 8-174](#).

Return to the [Table 8-149](#).

This register is the MSB data byte of IN3P monitoring.

Figure 8-197. DIAG_MON_MSB_IN3P Register

| | | | | | | | |
|------------------------|---|---|---|---|---|---|---|
| 7 | 6 | 5 | 4 | 3 | 2 | 1 | 0 |
| DIAG_MON_MSB_CH3P[7:0] | | | | | | | |
| R-00000000b | | | | | | | |

Table 8-174. DIAG_MON_MSB_IN3P Register Field Descriptions

| Bit | Field | Type | Reset | Description |
|-----|------------------------|------|-----------|---------------------------------------|
| 7-0 | DIAG_MON_MSB_CH3P[7:0] | R | 00000000b | Diagnostic SAR monitor data MSB byte. |

8.6.1.3.26 DIAG_MON_LSB_IN3P Register (Address = 0x67) [Reset = 0x6]

DIAG_MON_LSB_IN3P is shown in [Figure 8-198](#) and described in [Table 8-175](#).

Return to the [Table 8-149](#).

This register is the LSB data nibble of IN3P monitoring.

Figure 8-198. DIAG_MON_LSB_IN3P Register

| | | | | | | | |
|------------------------|---|---|---|-----------------|---|---|---|
| 7 | 6 | 5 | 4 | 3 | 2 | 1 | 0 |
| DIAG_MON_LSB_CH3P[3:0] | | | | CHANNEL_ID[3:0] | | | |
| R-0000b | | | | R-0110b | | | |

Table 8-175. DIAG_MON_LSB_IN3P Register Field Descriptions

| Bit | Field | Type | Reset | Description |
|-----|------------------------|------|-------|---|
| 7-4 | DIAG_MON_LSB_CH3P[3:0] | R | 0000b | Diagnostic SAR monitor data LSB nibble. |
| 3-0 | CHANNEL_ID[3:0] | R | 0110b | Channel ID value. |

8.6.1.3.27 DIAG_MON_MSB_IN3M Register (Address = 0x68) [Reset = 0x0]

DIAG_MON_MSB_IN3M is shown in [Figure 8-199](#) and described in [Table 8-176](#).

Return to the [Table 8-149](#).

This register is the MSB data byte of IN3M monitoring.

Figure 8-199. DIAG_MON_MSB_IN3M Register

| | | | | | | | |
|------------------------|---|---|---|---|---|---|---|
| 7 | 6 | 5 | 4 | 3 | 2 | 1 | 0 |
| DIAG_MON_MSB_CH3N[7:0] | | | | | | | |
| R-00000000b | | | | | | | |

Table 8-176. DIAG_MON_MSB_IN3M Register Field Descriptions

| Bit | Field | Type | Reset | Description |
|-----|------------------------|------|-----------|---------------------------------------|
| 7-0 | DIAG_MON_MSB_CH3N[7:0] | R | 00000000b | Diagnostic SAR monitor data MSB byte. |

8.6.1.3.28 DIAG_MON_LSB_IN3M Register (Address = 0x69) [Reset = 0x7]

DIAG_MON_LSB_IN3M is shown in [Figure 8-200](#) and described in [Table 8-177](#).

Return to the [Table 8-149](#).

This register is the LSB data nibble of IN3M monitoring.

Figure 8-200. DIAG_MON_LSB_IN3M Register

| | | | | | | | |
|------------------------|---|---|---|-----------------|---|---|---|
| 7 | 6 | 5 | 4 | 3 | 2 | 1 | 0 |
| DIAG_MON_LSB_CH3N[3:0] | | | | CHANNEL_ID[3:0] | | | |
| R-0000b | | | | R-0111b | | | |

Table 8-177. DIAG_MON_LSB_IN3M Register Field Descriptions

| Bit | Field | Type | Reset | Description |
|-----|------------------------|------|-------|---|
| 7-4 | DIAG_MON_LSB_CH3N[3:0] | R | 0000b | Diagnostic SAR monitor data LSB nibble. |
| 3-0 | CHANNEL_ID[3:0] | R | 0111b | Channel ID value. |

8.6.1.3.29 DIAG_MON_MSB_IN4P Register (Address = 0x6A) [Reset = 0x0]

DIAG_MON_MSB_IN4P is shown in [Figure 8-201](#) and described in [Table 8-178](#).

Return to the [Table 8-149](#).

This register is the MSB data byte of IN4P monitoring.

Figure 8-201. DIAG_MON_MSB_IN4P Register

| | | | | | | | |
|------------------------|---|---|---|---|---|---|---|
| 7 | 6 | 5 | 4 | 3 | 2 | 1 | 0 |
| DIAG_MON_MSB_CH4P[7:0] | | | | | | | |
| R-00000000b | | | | | | | |

Table 8-178. DIAG_MON_MSB_IN4P Register Field Descriptions

| Bit | Field | Type | Reset | Description |
|-----|------------------------|------|-----------|---------------------------------------|
| 7-0 | DIAG_MON_MSB_CH4P[7:0] | R | 00000000b | Diagnostic SAR monitor data MSB byte. |

8.6.1.3.30 DIAG_MON_LSB_IN4P Register (Address = 0x6B) [Reset = 0x8]

DIAG_MON_LSB_IN4P is shown in [Figure 8-202](#) and described in [Table 8-179](#).

Return to the [Table 8-149](#).

This register is the LSB data nibble of IN4P monitoring.

Figure 8-202. DIAG_MON_LSB_IN4P Register

| | | | | | | | |
|------------------------|---|---|---|-----------------|---|---|---|
| 7 | 6 | 5 | 4 | 3 | 2 | 1 | 0 |
| DIAG_MON_LSB_CH4P[3:0] | | | | CHANNEL_ID[3:0] | | | |
| R-0000b | | | | R-1000b | | | |

Table 8-179. DIAG_MON_LSB_IN4P Register Field Descriptions

| Bit | Field | Type | Reset | Description |
|-----|------------------------|------|-------|---|
| 7-4 | DIAG_MON_LSB_CH4P[3:0] | R | 0000b | Diagnostic SAR monitor data LSB nibble. |
| 3-0 | CHANNEL_ID[3:0] | R | 1000b | Channel ID value. |

8.6.1.3.31 DIAG_MON_MSB_IN4M Register (Address = 0x6C) [Reset = 0x0]

DIAG_MON_MSB_IN4M is shown in [Figure 8-203](#) and described in [Table 8-180](#).

Return to the [Table 8-149](#).

This register is the MSB data byte of IN4M monitoring.

Figure 8-203. DIAG_MON_MSB_IN4M Register

| | | | | | | | |
|------------------------|---|---|---|---|---|---|---|
| 7 | 6 | 5 | 4 | 3 | 2 | 1 | 0 |
| DIAG_MON_MSB_CH4N[7:0] | | | | | | | |
| R-00000000b | | | | | | | |

Table 8-180. DIAG_MON_MSB_IN4M Register Field Descriptions

| Bit | Field | Type | Reset | Description |
|-----|------------------------|------|-----------|---------------------------------------|
| 7-0 | DIAG_MON_MSB_CH4N[7:0] | R | 00000000b | Diagnostic SAR monitor data MSB byte. |

8.6.1.3.32 DIAG_MON_LSB_IN4M Register (Address = 0x6D) [Reset = 0x9]

DIAG_MON_LSB_IN4M is shown in [Figure 8-204](#) and described in [Table 8-181](#).

Return to the [Table 8-149](#).

This register is the LSB data nibble of IN4M monitoring.

Figure 8-204. DIAG_MON_LSB_IN4M Register

| | | | | | | | |
|------------------------|---|---|---|-----------------|---|---|---|
| 7 | 6 | 5 | 4 | 3 | 2 | 1 | 0 |
| DIAG_MON_LSB_CH4N[3:0] | | | | CHANNEL_ID[3:0] | | | |
| R-0000b | | | | R-1001b | | | |

Table 8-181. DIAG_MON_LSB_IN4M Register Field Descriptions

| Bit | Field | Type | Reset | Description |
|-----|------------------------|------|-------|---|
| 7-4 | DIAG_MON_LSB_CH4N[3:0] | R | 0000b | Diagnostic SAR monitor data LSB nibble. |
| 3-0 | CHANNEL_ID[3:0] | R | 1001b | Channel ID value. |

8.6.1.3.33 DIAG_MON_MSB_TEMP Register (Address = 0x76) [Reset = 0x0]

DIAG_MON_MSB_TEMP is shown in [Figure 8-205](#) and described in [Table 8-182](#).

Return to the [Table 8-149](#).

This register is the MSB data byte of temperature monitoring.

Figure 8-205. DIAG_MON_MSB_TEMP Register

| | | | | | | | |
|------------------------|---|---|---|---|---|---|---|
| 7 | 6 | 5 | 4 | 3 | 2 | 1 | 0 |
| DIAG_MON_MSB_TEMP[7:0] | | | | | | | |
| R-00000000b | | | | | | | |

Table 8-182. DIAG_MON_MSB_TEMP Register Field Descriptions

| Bit | Field | Type | Reset | Description |
|-----|------------------------|------|-----------|---------------------------------------|
| 7-0 | DIAG_MON_MSB_TEMP[7:0] | R | 00000000b | Diagnostic SAR monitor data MSB byte. |

8.6.1.3.34 DIAG_MON_LSB_TEMP Register (Address = 0x77) [Reset = 0xE]

DIAG_MON_LSB_TEMP is shown in [Figure 8-206](#) and described in [Table 8-183](#).

Return to the [Table 8-149](#).

This register is the LSB data nibble of temperature monitoring.

Figure 8-206. DIAG_MON_LSB_TEMP Register

| | | | | | | | |
|------------------------|---|---|---|-----------------|---|---|---|
| 7 | 6 | 5 | 4 | 3 | 2 | 1 | 0 |
| DIAG_MON_LSB_TEMP[3:0] | | | | CHANNEL_ID[3:0] | | | |
| R-0000b | | | | R-1110b | | | |

Table 8-183. DIAG_MON_LSB_TEMP Register Field Descriptions

| Bit | Field | Type | Reset | Description |
|-----|------------------------|------|-------|---|
| 7-4 | DIAG_MON_LSB_TEMP[3:0] | R | 0000b | Diagnostic SAR monitor data LSB nibble. |
| 3-0 | CHANNEL_ID[3:0] | R | 1110b | Channel ID value. |

8.6.1.3.35 DIAG_MON_MSB_LOAD Register (Address = 0x78) [Reset = 0x0]

DIAG_MON_MSB_LOAD is shown in [Figure 8-207](#) and described in [Table 8-184](#).

Return to the [Table 8-149](#).

This register is the MSB data byte of MICBIAS load current monitoring.

Figure 8-207. DIAG_MON_MSB_LOAD Register

| | | | | | | | |
|------------------------|---|---|---|---|---|---|---|
| 7 | 6 | 5 | 4 | 3 | 2 | 1 | 0 |
| DIAG_MON_MSB_LOAD[7:0] | | | | | | | |
| R-00000000b | | | | | | | |

Table 8-184. DIAG_MON_MSB_LOAD Register Field Descriptions

| Bit | Field | Type | Reset | Description |
|-----|------------------------|------|-----------|---------------------------------------|
| 7-0 | DIAG_MON_MSB_LOAD[7:0] | R | 00000000b | Diagnostic SAR monitor data MSB byte. |

8.6.1.3.36 DIAG_MON_LSB_LOAD Register (Address = 0x79) [Reset = 0xF]

DIAG_MON_LSB_LOAD is shown in [Figure 8-208](#) and described in [Table 8-185](#).

Return to the [Table 8-149](#).

This register is the LSB data nibble of MICBIAS load current monitoring.

Figure 8-208. DIAG_MON_LSB_LOAD Register

| | | | | | | | |
|------------------------|---|---|---|-----------------|---|---|---|
| 7 | 6 | 5 | 4 | 3 | 2 | 1 | 0 |
| DIAG_MON_LSB_LOAD[3:0] | | | | CHANNEL_ID[3:0] | | | |
| R-0000b | | | | R-1111b | | | |

Table 8-185. DIAG_MON_LSB_LOAD Register Field Descriptions

| Bit | Field | Type | Reset | Description |
|-----|------------------------|------|-------|---|
| 7-4 | DIAG_MON_LSB_LOAD[3:0] | R | 0000b | Diagnostic SAR monitor data LSB nibble. |
| 3-0 | CHANNEL_ID[3:0] | R | 1111b | Channel ID value. |

8.6.1.3.37 REV_ID Register (Address = 0x7E) [Reset = 0x20]

REV_ID is shown in [Figure 8-209](#) and described in [Table 8-186](#).

Return to the [Table 8-149](#).

This register is the silicon revision ID register.

Figure 8-209. REV_ID Register

| | | | | | | | |
|-------------|---|---|---|----------|---|---|---|
| 7 | 6 | 5 | 4 | 3 | 2 | 1 | 0 |
| REV_ID[3:0] | | | | RESERVED | | | |
| R-0010b | | | | R-0000b | | | |

Table 8-186. REV_ID Register Field Descriptions

| Bit | Field | Type | Reset | Description |
|-----|-------------|------|-------|--|
| 7-4 | REV_ID[3:0] | R | 0010b | Returns the revision ID. |
| 3-0 | RESERVED | R | 0000b | Reserved bits; Write only reset values |

8.6.2 Programmable Coefficient Registers

8.6.2.1 Programmable Coefficient Registers: Page 2

This register page (shown in [Table 8-187](#)) consists of the programmable coefficients for the biquad 1 to biquad 6 filters. To optimize the coefficients register transaction time for page 2, page 3, and page 4, the device also supports (by default) auto-incremented pages for the I²C and SPI burst writes and reads. After a transaction of register address 0x7F, the device auto increments to the next page at register 0x08 to transact the next coefficient value. These programmable coefficients are 32-bit, two's complement numbers. For a successful coefficient register transaction, the host device must write and read all four bytes starting with the most significant byte (BYT1) for a target coefficient register transaction. When using SPI for a coefficient register read transaction, the device transmits the first byte as a dummy read byte; therefore, the host must read five bytes, including the first dummy read byte and the last four bytes corresponding to the coefficient register value starting with the most significant byte (BYT1).

Table 8-187. Page 2 Programmable Coefficient Registers

| ADDRESS | ACRONYM | RESET VALUE | REGISTER DESCRIPTION |
|---------|------------------|-------------|---|
| 0x00 | PAGE[7:0] | 0x00 | Section 8.6.1.2.1 |
| 0x08 | BQ1_N0_BYT1[7:0] | 0x7F | Programmable biquad 1, N0 coefficient byte[31:24] |
| 0x09 | BQ1_N0_BYT2[7:0] | 0xFF | Programmable biquad 1, N0 coefficient byte[23:16] |
| 0x0A | BQ1_N0_BYT3[7:0] | 0xFF | Programmable biquad 1, N0 coefficient byte[15:8] |
| 0x0B | BQ1_N0_BYT4[7:0] | 0xFF | Programmable biquad 1, N0 coefficient byte[7:0] |
| 0x0C | BQ1_N1_BYT1[7:0] | 0x00 | Programmable biquad 1, N1 coefficient byte[31:24] |
| 0x0D | BQ1_N1_BYT2[7:0] | 0x00 | Programmable biquad 1, N1 coefficient byte[23:16] |
| 0x0E | BQ1_N1_BYT3[7:0] | 0x00 | Programmable biquad 1, N1 coefficient byte[15:8] |
| 0x0F | BQ1_N1_BYT4[7:0] | 0x00 | Programmable biquad 1, N1 coefficient byte[7:0] |
| 0x10 | BQ1_N2_BYT1[7:0] | 0x00 | Programmable biquad 1, N2 coefficient byte[31:24] |
| 0x11 | BQ1_N2_BYT2[7:0] | 0x00 | Programmable biquad 1, N2 coefficient byte[23:16] |
| 0x12 | BQ1_N2_BYT3[7:0] | 0x00 | Programmable biquad 1, N2 coefficient byte[15:8] |
| 0x13 | BQ1_N2_BYT4[7:0] | 0x00 | Programmable biquad 1, N2 coefficient byte[7:0] |
| 0x14 | BQ1_D1_BYT1[7:0] | 0x00 | Programmable biquad 1, D1 coefficient byte[31:24] |
| 0x15 | BQ1_D1_BYT2[7:0] | 0x00 | Programmable biquad 1, D1 coefficient byte[23:16] |
| 0x16 | BQ1_D1_BYT3[7:0] | 0x00 | Programmable biquad 1, D1 coefficient byte[15:8] |
| 0x17 | BQ1_D1_BYT4[7:0] | 0x00 | Programmable biquad 1, D1 coefficient byte[7:0] |
| 0x18 | BQ1_D2_BYT1[7:0] | 0x00 | Programmable biquad 1, D2 coefficient byte[31:24] |
| 0x19 | BQ1_D2_BYT2[7:0] | 0x00 | Programmable biquad 1, D2 coefficient byte[23:16] |
| 0x1A | BQ1_D2_BYT3[7:0] | 0x00 | Programmable biquad 1, D2 coefficient byte[15:8] |
| 0x1B | BQ1_D2_BYT4[7:0] | 0x00 | Programmable biquad 1, D2 coefficient byte[7:0] |
| 0x1C | BQ2_N0_BYT1[7:0] | 0x7F | Programmable biquad 2, N0 coefficient byte[31:24] |
| 0x1D | BQ2_N0_BYT2[7:0] | 0xFF | Programmable biquad 2, N0 coefficient byte[23:16] |
| 0x1E | BQ2_N0_BYT3[7:0] | 0xFF | Programmable biquad 2, N0 coefficient byte[15:8] |
| 0x1F | BQ2_N0_BYT4[7:0] | 0xFF | Programmable biquad 2, N0 coefficient byte[7:0] |
| 0x20 | BQ2_N1_BYT1[7:0] | 0x00 | Programmable biquad 2, N1 coefficient byte[31:24] |
| 0x21 | BQ2_N1_BYT2[7:0] | 0x00 | Programmable biquad 2, N1 coefficient byte[23:16] |
| 0x22 | BQ2_N1_BYT3[7:0] | 0x00 | Programmable biquad 2, N1 coefficient byte[15:8] |
| 0x23 | BQ2_N1_BYT4[7:0] | 0x00 | Programmable biquad 2, N1 coefficient byte[7:0] |
| 0x24 | BQ2_N2_BYT1[7:0] | 0x00 | Programmable biquad 2, N2 coefficient byte[31:24] |
| 0x25 | BQ2_N2_BYT2[7:0] | 0x00 | Programmable biquad 2, N2 coefficient byte[23:16] |
| 0x26 | BQ2_N2_BYT3[7:0] | 0x00 | Programmable biquad 2, N2 coefficient byte[15:8] |
| 0x27 | BQ2_N2_BYT4[7:0] | 0x00 | Programmable biquad 2, N2 coefficient byte[7:0] |
| 0x28 | BQ2_D1_BYT1[7:0] | 0x00 | Programmable biquad 2, D1 coefficient byte[31:24] |
| 0x29 | BQ2_D1_BYT2[7:0] | 0x00 | Programmable biquad 2, D1 coefficient byte[23:16] |
| 0x2A | BQ2_D1_BYT3[7:0] | 0x00 | Programmable biquad 2, D1 coefficient byte[15:8] |
| 0x2B | BQ2_D1_BYT4[7:0] | 0x00 | Programmable biquad 2, D1 coefficient byte[7:0] |

Table 8-187. Page 2 Programmable Coefficient Registers (continued)

| ADDRESS | ACRONYM | RESET VALUE | REGISTER DESCRIPTION |
|---------|------------------|-------------|---|
| 0x2C | BQ2_D2_BYT1[7:0] | 0x00 | Programmable biquad 2, D2 coefficient byte[31:24] |
| 0x2D | BQ2_D2_BYT2[7:0] | 0x00 | Programmable biquad 2, D2 coefficient byte[23:16] |
| 0x2E | BQ2_D2_BYT3[7:0] | 0x00 | Programmable biquad 2, D2 coefficient byte[15:8] |
| 0x2F | BQ2_D2_BYT4[7:0] | 0x00 | Programmable biquad 2, D2 coefficient byte[7:0] |
| 0x30 | BQ3_N0_BYT1[7:0] | 0x7F | Programmable biquad 3, N0 coefficient byte[31:24] |
| 0x31 | BQ3_N0_BYT2[7:0] | 0xFF | Programmable biquad 3, N0 coefficient byte[23:16] |
| 0x32 | BQ3_N0_BYT3[7:0] | 0xFF | Programmable biquad 3, N0 coefficient byte[15:8] |
| 0x33 | BQ3_N0_BYT4[7:0] | 0xFF | Programmable biquad 3, N0 coefficient byte[7:0] |
| 0x34 | BQ3_N1_BYT1[7:0] | 0x00 | Programmable biquad 3, N1 coefficient byte[31:24] |
| 0x35 | BQ3_N1_BYT2[7:0] | 0x00 | Programmable biquad 3, N1 coefficient byte[23:16] |
| 0x36 | BQ3_N1_BYT3[7:0] | 0x00 | Programmable biquad 3, N1 coefficient byte[15:8] |
| 0x37 | BQ3_N1_BYT4[7:0] | 0x00 | Programmable biquad 3, N1 coefficient byte[7:0] |
| 0x38 | BQ3_N2_BYT1[7:0] | 0x00 | Programmable biquad 3, N2 coefficient byte[31:24] |
| 0x39 | BQ3_N2_BYT2[7:0] | 0x00 | Programmable biquad 3, N2 coefficient byte[23:16] |
| 0x3A | BQ3_N2_BYT3[7:0] | 0x00 | Programmable biquad 3, N2 coefficient byte[15:8] |
| 0x3B | BQ3_N2_BYT4[7:0] | 0x00 | Programmable biquad 3, N2 coefficient byte[7:0] |
| 0x3C | BQ3_D1_BYT1[7:0] | 0x00 | Programmable biquad 3, D1 coefficient byte[31:24] |
| 0x3D | BQ3_D1_BYT2[7:0] | 0x00 | Programmable biquad 3, D1 coefficient byte[23:16] |
| 0x3E | BQ3_D1_BYT3[7:0] | 0x00 | Programmable biquad 3, D1 coefficient byte[15:8] |
| 0x3F | BQ3_D1_BYT4[7:0] | 0x00 | Programmable biquad 3, D1 coefficient byte[7:0] |
| 0x40 | BQ3_D2_BYT1[7:0] | 0x00 | Programmable biquad 3, D2 coefficient byte[31:24] |
| 0x41 | BQ3_D2_BYT2[7:0] | 0x00 | Programmable biquad 3, D2 coefficient byte[23:16] |
| 0x42 | BQ3_D2_BYT3[7:0] | 0x00 | Programmable biquad 3, D2 coefficient byte[15:8] |
| 0x43 | BQ3_D2_BYT4[7:0] | 0x00 | Programmable biquad 3, D2 coefficient byte[7:0] |
| 0x44 | BQ4_N0_BYT1[7:0] | 0x7F | Programmable biquad 4, N0 coefficient byte[31:24] |
| 0x45 | BQ4_N0_BYT2[7:0] | 0xFF | Programmable biquad 4, N0 coefficient byte[23:16] |
| 0x46 | BQ4_N0_BYT3[7:0] | 0xFF | Programmable biquad 4, N0 coefficient byte[15:8] |
| 0x47 | BQ4_N0_BYT4[7:0] | 0xFF | Programmable biquad 4, N0 coefficient byte[7:0] |
| 0x48 | BQ4_N1_BYT1[7:0] | 0x00 | Programmable biquad 4, N1 coefficient byte[31:24] |
| 0x49 | BQ4_N1_BYT2[7:0] | 0x00 | Programmable biquad 4, N1 coefficient byte[23:16] |
| 0x4A | BQ4_N1_BYT3[7:0] | 0x00 | Programmable biquad 4, N1 coefficient byte[15:8] |
| 0x4B | BQ4_N1_BYT4[7:0] | 0x00 | Programmable biquad 4, N1 coefficient byte[7:0] |
| 0x4C | BQ4_N2_BYT1[7:0] | 0x00 | Programmable biquad 4, N2 coefficient byte[31:24] |
| 0x4D | BQ4_N2_BYT2[7:0] | 0x00 | Programmable biquad 4, N2 coefficient byte[23:16] |
| 0x4E | BQ4_N2_BYT3[7:0] | 0x00 | Programmable biquad 4, N2 coefficient byte[15:8] |
| 0x4F | BQ4_N2_BYT4[7:0] | 0x00 | Programmable biquad 4, N2 coefficient byte[7:0] |
| 0x50 | BQ4_D1_BYT1[7:0] | 0x00 | Programmable biquad 4, D1 coefficient byte[31:24] |
| 0x51 | BQ4_D1_BYT2[7:0] | 0x00 | Programmable biquad 4, D1 coefficient byte[23:16] |
| 0x52 | BQ4_D1_BYT3[7:0] | 0x00 | Programmable biquad 4, D1 coefficient byte[15:8] |
| 0x53 | BQ4_D1_BYT4[7:0] | 0x00 | Programmable biquad 4, D1 coefficient byte[7:0] |
| 0x54 | BQ4_D2_BYT1[7:0] | 0x00 | Programmable biquad 4, D2 coefficient byte[31:24] |
| 0x55 | BQ4_D2_BYT2[7:0] | 0x00 | Programmable biquad 4, D2 coefficient byte[23:16] |
| 0x56 | BQ4_D2_BYT3[7:0] | 0x00 | Programmable biquad 4, D2 coefficient byte[15:8] |
| 0x57 | BQ4_D2_BYT4[7:0] | 0x00 | Programmable biquad 4, D2 coefficient byte[7:0] |
| 0x58 | BQ5_N0_BYT1[7:0] | 0x7F | Programmable biquad 5, N0 coefficient byte[31:24] |
| 0x59 | BQ5_N0_BYT2[7:0] | 0xFF | Programmable biquad 5, N0 coefficient byte[23:16] |
| 0x5A | BQ5_N0_BYT3[7:0] | 0xFF | Programmable biquad 5, N0 coefficient byte[15:8] |
| 0x5B | BQ5_N0_BYT4[7:0] | 0xFF | Programmable biquad 5, N0 coefficient byte[7:0] |
| 0x5C | BQ5_N1_BYT1[7:0] | 0x00 | Programmable biquad 5, N1 coefficient byte[31:24] |
| 0x5D | BQ5_N1_BYT2[7:0] | 0x00 | Programmable biquad 5, N1 coefficient byte[23:16] |

Table 8-187. Page 2 Programmable Coefficient Registers (continued)

| ADDRESS | ACRONYM | RESET VALUE | REGISTER DESCRIPTION |
|---------|------------------|-------------|---|
| 0x5E | BQ5_N1_BYT3[7:0] | 0x00 | Programmable biquad 5, N1 coefficient byte[15:8] |
| 0x5F | BQ5_N1_BYT4[7:0] | 0x00 | Programmable biquad 5, N1 coefficient byte[7:0] |
| 0x60 | BQ5_N2_BYT1[7:0] | 0x00 | Programmable biquad 5, N2 coefficient byte[31:24] |
| 0x61 | BQ5_N2_BYT2[7:0] | 0x00 | Programmable biquad 5, N2 coefficient byte[23:16] |
| 0x62 | BQ5_N2_BYT3[7:0] | 0x00 | Programmable biquad 5, N2 coefficient byte[15:8] |
| 0x63 | BQ5_N2_BYT4[7:0] | 0x00 | Programmable biquad 5, N2 coefficient byte[7:0] |
| 0x64 | BQ5_D1_BYT1[7:0] | 0x00 | Programmable biquad 5, D1 coefficient byte[31:24] |
| 0x65 | BQ5_D1_BYT2[7:0] | 0x00 | Programmable biquad 5, D1 coefficient byte[23:16] |
| 0x66 | BQ5_D1_BYT3[7:0] | 0x00 | Programmable biquad 5, D1 coefficient byte[15:8] |
| 0x67 | BQ5_D1_BYT4[7:0] | 0x00 | Programmable biquad 5, D1 coefficient byte[7:0] |
| 0x68 | BQ5_D2_BYT1[7:0] | 0x00 | Programmable biquad 5, D2 coefficient byte[31:24] |
| 0x69 | BQ5_D2_BYT2[7:0] | 0x00 | Programmable biquad 5, D2 coefficient byte[23:16] |
| 0x6A | BQ5_D2_BYT3[7:0] | 0x00 | Programmable biquad 5, D2 coefficient byte[15:8] |
| 0x6B | BQ5_D2_BYT4[7:0] | 0x00 | Programmable biquad 5, D2 coefficient byte[7:0] |
| 0x6C | BQ6_N0_BYT1[7:0] | 0x7F | Programmable biquad 6, N0 coefficient byte[31:24] |
| 0x6D | BQ6_N0_BYT2[7:0] | 0xFF | Programmable biquad 6, N0 coefficient byte[23:16] |
| 0x6E | BQ6_N0_BYT3[7:0] | 0xFF | Programmable biquad 6, N0 coefficient byte[15:8] |
| 0x6F | BQ6_N0_BYT4[7:0] | 0xFF | Programmable biquad 6, N0 coefficient byte[7:0] |
| 0x70 | BQ6_N1_BYT1[7:0] | 0x00 | Programmable biquad 6, N1 coefficient byte[31:24] |
| 0x71 | BQ6_N1_BYT2[7:0] | 0x00 | Programmable biquad 6, N1 coefficient byte[23:16] |
| 0x72 | BQ6_N1_BYT3[7:0] | 0x00 | Programmable biquad 6, N1 coefficient byte[15:8] |
| 0x73 | BQ6_N1_BYT4[7:0] | 0x00 | Programmable biquad 6, N1 coefficient byte[7:0] |
| 0x74 | BQ6_N2_BYT1[7:0] | 0x00 | Programmable biquad 6, N2 coefficient byte[31:24] |
| 0x75 | BQ6_N2_BYT2[7:0] | 0x00 | Programmable biquad 6, N2 coefficient byte[23:16] |
| 0x76 | BQ6_N2_BYT3[7:0] | 0x00 | Programmable biquad 6, N2 coefficient byte[15:8] |
| 0x77 | BQ6_N2_BYT4[7:0] | 0x00 | Programmable biquad 6, N2 coefficient byte[7:0] |
| 0x78 | BQ6_D1_BYT1[7:0] | 0x00 | Programmable biquad 6, D1 coefficient byte[31:24] |
| 0x79 | BQ6_D1_BYT2[7:0] | 0x00 | Programmable biquad 6, D1 coefficient byte[23:16] |
| 0x7A | BQ6_D1_BYT3[7:0] | 0x00 | Programmable biquad 6, D1 coefficient byte[15:8] |
| 0x7B | BQ6_D1_BYT4[7:0] | 0x00 | Programmable biquad 6, D1 coefficient byte[7:0] |
| 0x7C | BQ6_D2_BYT1[7:0] | 0x00 | Programmable biquad 6, D2 coefficient byte[31:24] |
| 0x7D | BQ6_D2_BYT2[7:0] | 0x00 | Programmable biquad 6, D2 coefficient byte[23:16] |
| 0x7E | BQ6_D2_BYT3[7:0] | 0x00 | Programmable biquad 6, D2 coefficient byte[15:8] |
| 0x7F | BQ6_D2_BYT4[7:0] | 0x00 | Programmable biquad 6, D2 coefficient byte[7:0] |

8.6.2.2 Programmable Coefficient Registers: Page 3

This register page (shown in [Table 8-188](#)) consists of the programmable coefficients for the biquad 7 to biquad 12 filters. To optimize the coefficients register transaction time for page 2, page 3, and page 4, the device also supports (by default) auto-incremented pages for the I²C and SPI burst writes and reads. After a transaction of register address 0x7F, the device auto increments to the next page at register 0x08 to transact the next coefficient value. These programmable coefficients are 32-bit, two's complement numbers. For a successful coefficient register transaction, the host device must write and read all four bytes starting with the most significant byte (BYT1) for a target coefficient register transaction. When using SPI for a coefficient register read transaction, the device transmits the first byte as a dummy read byte; therefore, the host must read five bytes, including the first dummy read byte and the last four bytes corresponding to the coefficient register value starting with the most significant byte (BYT1).

Table 8-188. Page 3 Programmable Coefficient Registers

| ADDRESS | ACRONYM | RESET VALUE | REGISTER DESCRIPTION |
|---------|------------------|-------------|---|
| 0x00 | PAGE[7:0] | 0x00 | Section 8.6.1.2.1 |
| 0x08 | BQ7_N0_BYT1[7:0] | 0x7F | Programmable biquad 7, N0 coefficient byte[31:24] |
| 0x09 | BQ7_N0_BYT2[7:0] | 0xFF | Programmable biquad 7, N0 coefficient byte[23:16] |
| 0x0A | BQ7_N0_BYT3[7:0] | 0xFF | Programmable biquad 7, N0 coefficient byte[15:8] |
| 0x0B | BQ7_N0_BYT4[7:0] | 0xFF | Programmable biquad 7, N0 coefficient byte[7:0] |
| 0x0C | BQ7_N1_BYT1[7:0] | 0x00 | Programmable biquad 7, N1 coefficient byte[31:24] |
| 0x0D | BQ7_N1_BYT2[7:0] | 0x00 | Programmable biquad 7, N1 coefficient byte[23:16] |
| 0x0E | BQ7_N1_BYT3[7:0] | 0x00 | Programmable biquad 7, N1 coefficient byte[15:8] |
| 0x0F | BQ7_N1_BYT4[7:0] | 0x00 | Programmable biquad 7, N1 coefficient byte[7:0] |
| 0x10 | BQ7_N2_BYT1[7:0] | 0x00 | Programmable biquad 7, N2 coefficient byte[31:24] |
| 0x11 | BQ7_N2_BYT2[7:0] | 0x00 | Programmable biquad 7, N2 coefficient byte[23:16] |
| 0x12 | BQ7_N2_BYT3[7:0] | 0x00 | Programmable biquad 7, N2 coefficient byte[15:8] |
| 0x13 | BQ7_N2_BYT4[7:0] | 0x00 | Programmable biquad 7, N2 coefficient byte[7:0] |
| 0x14 | BQ7_D1_BYT1[7:0] | 0x00 | Programmable biquad 7, D1 coefficient byte[31:24] |
| 0x15 | BQ7_D1_BYT2[7:0] | 0x00 | Programmable biquad 7, D1 coefficient byte[23:16] |
| 0x16 | BQ7_D1_BYT3[7:0] | 0x00 | Programmable biquad 7, D1 coefficient byte[15:8] |
| 0x17 | BQ7_D1_BYT4[7:0] | 0x00 | Programmable biquad 7, D1 coefficient byte[7:0] |
| 0x18 | BQ7_D2_BYT1[7:0] | 0x00 | Programmable biquad 7, D2 coefficient byte[31:24] |
| 0x19 | BQ7_D2_BYT2[7:0] | 0x00 | Programmable biquad 7, D2 coefficient byte[23:16] |
| 0x1A | BQ7_D2_BYT3[7:0] | 0x00 | Programmable biquad 7, D2 coefficient byte[15:8] |
| 0x1B | BQ7_D2_BYT4[7:0] | 0x00 | Programmable biquad 7, D2 coefficient byte[7:0] |
| 0x1C | BQ8_N0_BYT1[7:0] | 0x7F | Programmable biquad 8, N0 coefficient byte[31:24] |
| 0x1D | BQ8_N0_BYT2[7:0] | 0xFF | Programmable biquad 8, N0 coefficient byte[23:16] |
| 0x1E | BQ8_N0_BYT3[7:0] | 0xFF | Programmable biquad 8, N0 coefficient byte[15:8] |
| 0x1F | BQ8_N0_BYT4[7:0] | 0xFF | Programmable biquad 8, N0 coefficient byte[7:0] |
| 0x20 | BQ8_N1_BYT1[7:0] | 0x00 | Programmable biquad 8, N1 coefficient byte[31:24] |
| 0x21 | BQ8_N1_BYT2[7:0] | 0x00 | Programmable biquad 8, N1 coefficient byte[23:16] |
| 0x22 | BQ8_N1_BYT3[7:0] | 0x00 | Programmable biquad 8, N1 coefficient byte[15:8] |
| 0x23 | BQ8_N1_BYT4[7:0] | 0x00 | Programmable biquad 8, N1 coefficient byte[7:0] |
| 0x24 | BQ8_N2_BYT1[7:0] | 0x00 | Programmable biquad 8, N2 coefficient byte[31:24] |
| 0x25 | BQ8_N2_BYT2[7:0] | 0x00 | Programmable biquad 8, N2 coefficient byte[23:16] |
| 0x26 | BQ8_N2_BYT3[7:0] | 0x00 | Programmable biquad 8, N2 coefficient byte[15:8] |
| 0x27 | BQ8_N2_BYT4[7:0] | 0x00 | Programmable biquad 8, N2 coefficient byte[7:0] |
| 0x28 | BQ8_D1_BYT1[7:0] | 0x00 | Programmable biquad 8, D1 coefficient byte[31:24] |
| 0x29 | BQ8_D1_BYT2[7:0] | 0x00 | Programmable biquad 8, D1 coefficient byte[23:16] |
| 0x2A | BQ8_D1_BYT3[7:0] | 0x00 | Programmable biquad 8, D1 coefficient byte[15:8] |
| 0x2B | BQ8_D1_BYT4[7:0] | 0x00 | Programmable biquad 8, D1 coefficient byte[7:0] |
| 0x2C | BQ8_D2_BYT1[7:0] | 0x00 | Programmable biquad 8, D2 coefficient byte[31:24] |

Table 8-188. Page 3 Programmable Coefficient Registers (continued)

| ADDRESS | ACRONYM | RESET VALUE | REGISTER DESCRIPTION |
|---------|-------------------|-------------|--|
| 0x2D | BQ8_D2_BYT2[7:0] | 0x00 | Programmable biquad 8, D2 coefficient byte[23:16] |
| 0x2E | BQ8_D2_BYT3[7:0] | 0x00 | Programmable biquad 8, D2 coefficient byte[15:8] |
| 0x2F | BQ8_D2_BYT4[7:0] | 0x00 | Programmable biquad 8, D2 coefficient byte[7:0] |
| 0x30 | BQ9_N0_BYT1[7:0] | 0x7F | Programmable biquad 9, N0 coefficient byte[31:24] |
| 0x31 | BQ9_N0_BYT2[7:0] | 0xFF | Programmable biquad 9, N0 coefficient byte[23:16] |
| 0x32 | BQ9_N0_BYT3[7:0] | 0xFF | Programmable biquad 9, N0 coefficient byte[15:8] |
| 0x33 | BQ9_N0_BYT4[7:0] | 0xFF | Programmable biquad 9, N0 coefficient byte[7:0] |
| 0x34 | BQ9_N1_BYT1[7:0] | 0x00 | Programmable biquad 9, N1 coefficient byte[31:24] |
| 0x35 | BQ9_N1_BYT2[7:0] | 0x00 | Programmable biquad 9, N1 coefficient byte[23:16] |
| 0x36 | BQ9_N1_BYT3[7:0] | 0x00 | Programmable biquad 9, N1 coefficient byte[15:8] |
| 0x37 | BQ9_N1_BYT4[7:0] | 0x00 | Programmable biquad 9, N1 coefficient byte[7:0] |
| 0x38 | BQ9_N2_BYT1[7:0] | 0x00 | Programmable biquad 9, N2 coefficient byte[31:24] |
| 0x39 | BQ9_N2_BYT2[7:0] | 0x00 | Programmable biquad 9, N2 coefficient byte[23:16] |
| 0x3A | BQ9_N2_BYT3[7:0] | 0x00 | Programmable biquad 9, N2 coefficient byte[15:8] |
| 0x3B | BQ9_N2_BYT4[7:0] | 0x00 | Programmable biquad 9, N2 coefficient byte[7:0] |
| 0x3C | BQ9_D1_BYT1[7:0] | 0x00 | Programmable biquad 9, D1 coefficient byte[31:24] |
| 0x3D | BQ9_D1_BYT2[7:0] | 0x00 | Programmable biquad 9, D1 coefficient byte[23:16] |
| 0x3E | BQ9_D1_BYT3[7:0] | 0x00 | Programmable biquad 9, D1 coefficient byte[15:8] |
| 0x3F | BQ9_D1_BYT4[7:0] | 0x00 | Programmable biquad 9, D1 coefficient byte[7:0] |
| 0x40 | BQ9_D2_BYT1[7:0] | 0x00 | Programmable biquad 9, D2 coefficient byte[31:24] |
| 0x41 | BQ9_D2_BYT2[7:0] | 0x00 | Programmable biquad 9, D2 coefficient byte[23:16] |
| 0x42 | BQ9_D2_BYT3[7:0] | 0x00 | Programmable biquad 9, D2 coefficient byte[15:8] |
| 0x43 | BQ9_D2_BYT4[7:0] | 0x00 | Programmable biquad 9, D2 coefficient byte[7:0] |
| 0x44 | BQ10_N0_BYT1[7:0] | 0x7F | Programmable biquad 10, N0 coefficient byte[31:24] |
| 0x45 | BQ10_N0_BYT2[7:0] | 0xFF | Programmable biquad 10, N0 coefficient byte[23:16] |
| 0x46 | BQ10_N0_BYT3[7:0] | 0xFF | Programmable biquad 10, N0 coefficient byte[15:8] |
| 0x47 | BQ10_N0_BYT4[7:0] | 0xFF | Programmable biquad 10, N0 coefficient byte[7:0] |
| 0x48 | BQ10_N1_BYT1[7:0] | 0x00 | Programmable biquad 10, N1 coefficient byte[31:24] |
| 0x49 | BQ10_N1_BYT2[7:0] | 0x00 | Programmable biquad 10, N1 coefficient byte[23:16] |
| 0x4A | BQ10_N1_BYT3[7:0] | 0x00 | Programmable biquad 10, N1 coefficient byte[15:8] |
| 0x4B | BQ10_N1_BYT4[7:0] | 0x00 | Programmable biquad 10, N1 coefficient byte[7:0] |
| 0x4C | BQ10_N2_BYT1[7:0] | 0x00 | Programmable biquad 10, N2 coefficient byte[31:24] |
| 0x4D | BQ10_N2_BYT2[7:0] | 0x00 | Programmable biquad 10, N2 coefficient byte[23:16] |
| 0x4E | BQ10_N2_BYT3[7:0] | 0x00 | Programmable biquad 10, N2 coefficient byte[15:8] |
| 0x4F | BQ10_N2_BYT4[7:0] | 0x00 | Programmable biquad 10, N2 coefficient byte[7:0] |
| 0x50 | BQ10_D1_BYT1[7:0] | 0x00 | Programmable biquad 10, D1 coefficient byte[31:24] |
| 0x51 | BQ10_D1_BYT2[7:0] | 0x00 | Programmable biquad 10, D1 coefficient byte[23:16] |
| 0x52 | BQ10_D1_BYT3[7:0] | 0x00 | Programmable biquad 10, D1 coefficient byte[15:8] |
| 0x53 | BQ10_D1_BYT4[7:0] | 0x00 | Programmable biquad 10, D1 coefficient byte[7:0] |
| 0x54 | BQ10_D2_BYT1[7:0] | 0x00 | Programmable biquad 10, D2 coefficient byte[31:24] |
| 0x55 | BQ10_D2_BYT2[7:0] | 0x00 | Programmable biquad 10, D2 coefficient byte[23:16] |
| 0x56 | BQ10_D2_BYT3[7:0] | 0x00 | Programmable biquad 10, D2 coefficient byte[15:8] |
| 0x57 | BQ10_D2_BYT4[7:0] | 0x00 | Programmable biquad 10, D2 coefficient byte[7:0] |
| 0x58 | BQ11_N0_BYT1[7:0] | 0x7F | Programmable biquad 11, N0 coefficient byte[31:24] |
| 0x59 | BQ11_N0_BYT2[7:0] | 0xFF | Programmable biquad 11, N0 coefficient byte[23:16] |
| 0x5A | BQ11_N0_BYT3[7:0] | 0xFF | Programmable biquad 11, N0 coefficient byte[15:8] |
| 0x5B | BQ11_N0_BYT4[7:0] | 0xFF | Programmable biquad 11, N0 coefficient byte[7:0] |
| 0x5C | BQ11_N1_BYT1[7:0] | 0x00 | Programmable biquad 11, N1 coefficient byte[31:24] |
| 0x5D | BQ11_N1_BYT2[7:0] | 0x00 | Programmable biquad 11, N1 coefficient byte[23:16] |
| 0x5E | BQ11_N1_BYT3[7:0] | 0x00 | Programmable biquad 11, N1 coefficient byte[15:8] |

Table 8-188. Page 3 Programmable Coefficient Registers (continued)

| ADDRESS | ACRONYM | RESET VALUE | REGISTER DESCRIPTION |
|---------|-------------------|-------------|--|
| 0x5F | BQ11_N1_BYT4[7:0] | 0x00 | Programmable biquad 11, N1 coefficient byte[7:0] |
| 0x60 | BQ11_N2_BYT1[7:0] | 0x00 | Programmable biquad 11, N2 coefficient byte[31:24] |
| 0x61 | BQ11_N2_BYT2[7:0] | 0x00 | Programmable biquad 11, N2 coefficient byte[23:16] |
| 0x62 | BQ11_N2_BYT3[7:0] | 0x00 | Programmable biquad 11, N2 coefficient byte[15:8] |
| 0x63 | BQ11_N2_BYT4[7:0] | 0x00 | Programmable biquad 11, N2 coefficient byte[7:0] |
| 0x64 | BQ11_D1_BYT1[7:0] | 0x00 | Programmable biquad 11, D1 coefficient byte[31:24] |
| 0x65 | BQ11_D1_BYT2[7:0] | 0x00 | Programmable biquad 11, D1 coefficient byte[23:16] |
| 0x66 | BQ11_D1_BYT3[7:0] | 0x00 | Programmable biquad 11, D1 coefficient byte[15:8] |
| 0x67 | BQ11_D1_BYT4[7:0] | 0x00 | Programmable biquad 11, D1 coefficient byte[7:0] |
| 0x68 | BQ11_D2_BYT1[7:0] | 0x00 | Programmable biquad 11, D2 coefficient byte[31:24] |
| 0x69 | BQ11_D2_BYT2[7:0] | 0x00 | Programmable biquad 11, D2 coefficient byte[23:16] |
| 0x6A | BQ11_D2_BYT3[7:0] | 0x00 | Programmable biquad 11, D2 coefficient byte[15:8] |
| 0x6B | BQ11_D2_BYT4[7:0] | 0x00 | Programmable biquad 11, D2 coefficient byte[7:0] |
| 0x6C | BQ12_N0_BYT1[7:0] | 0x7F | Programmable biquad 12, N0 coefficient byte[31:24] |
| 0x6D | BQ12_N0_BYT2[7:0] | 0xFF | Programmable biquad 12, N0 coefficient byte[23:16] |
| 0x6E | BQ12_N0_BYT3[7:0] | 0xFF | Programmable biquad 12, N0 coefficient byte[15:8] |
| 0x6F | BQ12_N0_BYT4[7:0] | 0xFF | Programmable biquad 12, N0 coefficient byte[7:0] |
| 0x70 | BQ12_N1_BYT1[7:0] | 0x00 | Programmable biquad 12, N1 coefficient byte[31:24] |
| 0x71 | BQ12_N1_BYT2[7:0] | 0x00 | Programmable biquad 12, N1 coefficient byte[23:16] |
| 0x72 | BQ12_N1_BYT3[7:0] | 0x00 | Programmable biquad 12, N1 coefficient byte[15:8] |
| 0x73 | BQ12_N1_BYT4[7:0] | 0x00 | Programmable biquad 12, N1 coefficient byte[7:0] |
| 0x74 | BQ12_N2_BYT1[7:0] | 0x00 | Programmable biquad 12, N2 coefficient byte[31:24] |
| 0x75 | BQ12_N2_BYT2[7:0] | 0x00 | Programmable biquad 12, N2 coefficient byte[23:16] |
| 0x76 | BQ12_N2_BYT3[7:0] | 0x00 | Programmable biquad 12, N2 coefficient byte[15:8] |
| 0x77 | BQ12_N2_BYT4[7:0] | 0x00 | Programmable biquad 12, N2 coefficient byte[7:0] |
| 0x78 | BQ12_D1_BYT1[7:0] | 0x00 | Programmable biquad 12, D1 coefficient byte[31:24] |
| 0x79 | BQ12_D1_BYT2[7:0] | 0x00 | Programmable biquad 12, D1 coefficient byte[23:16] |
| 0x7A | BQ12_D1_BYT3[7:0] | 0x00 | Programmable biquad 12, D1 coefficient byte[15:8] |
| 0x7B | BQ12_D1_BYT4[7:0] | 0x00 | Programmable biquad 12, D1 coefficient byte[7:0] |
| 0x7C | BQ12_D2_BYT1[7:0] | 0x00 | Programmable biquad 12, D2 coefficient byte[31:24] |
| 0x7D | BQ12_D2_BYT2[7:0] | 0x00 | Programmable biquad 12, D2 coefficient byte[23:16] |
| 0x7E | BQ12_D2_BYT3[7:0] | 0x00 | Programmable biquad 12, D2 coefficient byte[15:8] |
| 0x7F | BQ12_D2_BYT4[7:0] | 0x00 | Programmable biquad 12, D2 coefficient byte[7:0] |

8.6.2.3 Programmable Coefficient Registers: Page 4

This register page (shown in [Table 8-189](#)) consists of the programmable coefficients for mixer 1 to mixer 4 and the first-order IIR filter. All mixer coefficients are 32-bit, two's complement numbers using a 1.31 number format. The value of 0x7FFFFFFF is equivalent to +1 (0-dB gain), the value 0x00000000 is equivalent to mute (zero data) and all values in between set the mixer attenuation computed using [Equation 4](#). If the MSB is set to '1' then the attenuation remains the same but the signal phase is inverted. All IIR filter programmable coefficients are 32-bit, two's complement numbers. For a successful coefficient register transaction, the host device must write and read all four bytes starting with the most significant byte (BYT1) for a target coefficient register transaction. When using SPI for a coefficient register read transaction, the device transmits the first byte as a dummy read byte; therefore, the host must read five bytes, including the first dummy read byte and the last four bytes corresponding to the coefficient register value starting with the most significant byte (BYT1).

$$\text{hex2dec}(\text{value}) / 2^{31} \quad (4)$$

Table 8-189. Page 4 Programmable Coefficient Registers

| ADDRESS | ACRONYM | RESET VALUE | REGISTER DESCRIPTION |
|---------|--------------------|-------------|--|
| 0x00 | PAGE[7:0] | 0x00 | Section 8.6.1.2.1 |
| 0x08 | MIX1_CH1_BYT1[7:0] | 0x7F | Digital mixer 1, channel 1 coefficient byte[31:24] |
| 0x09 | MIX1_CH1_BYT2[7:0] | 0xFF | Digital mixer 1, channel 1 coefficient byte[23:16] |
| 0x0A | MIX1_CH1_BYT3[7:0] | 0xFF | Digital mixer 1, channel 1 coefficient byte[15:8] |
| 0x0B | MIX1_CH1_BYT4[7:0] | 0xFF | Digital mixer 1, channel 1 coefficient byte[7:0] |
| 0x0C | MIX1_CH2_BYT1[7:0] | 0x00 | Digital mixer 1, channel 2 coefficient byte[31:24] |
| 0x0D | MIX1_CH2_BYT2[7:0] | 0x00 | Digital mixer 1, channel 2 coefficient byte[23:16] |
| 0x0E | MIX1_CH2_BYT3[7:0] | 0x00 | Digital mixer 1, channel 2 coefficient byte[15:8] |
| 0x0F | MIX1_CH2_BYT4[7:0] | 0x00 | Digital mixer 1, channel 2 coefficient byte[7:0] |
| 0x10 | MIX1_CH3_BYT1[7:0] | 0x00 | Digital mixer 1, channel 3 coefficient byte[31:24] |
| 0x11 | MIX1_CH3_BYT2[7:0] | 0x00 | Digital mixer 1, channel 3 coefficient byte[23:16] |
| 0x12 | MIX1_CH3_BYT3[7:0] | 0x00 | Digital mixer 1, channel 3 coefficient byte[15:8] |
| 0x13 | MIX1_CH3_BYT4[7:0] | 0x00 | Digital mixer 1, channel 3 coefficient byte[7:0] |
| 0x14 | MIX1_CH4_BYT1[7:0] | 0x00 | Digital mixer 1, channel 4 coefficient byte[31:24] |
| 0x15 | MIX1_CH4_BYT2[7:0] | 0x00 | Digital mixer 1, channel 4 coefficient byte[23:16] |
| 0x16 | MIX1_CH4_BYT3[7:0] | 0x00 | Digital mixer 1, channel 4 coefficient byte[15:8] |
| 0x17 | MIX1_CH4_BYT4[7:0] | 0x00 | Digital mixer 1, channel 4 coefficient byte[7:0] |
| 0x18 | MIX2_CH1_BYT1[7:0] | 0x00 | Digital mixer 2, channel 1 coefficient byte[31:24] |
| 0x19 | MIX2_CH1_BYT2[7:0] | 0x00 | Digital mixer 2, channel 1 coefficient byte[23:16] |
| 0x1A | MIX2_CH1_BYT3[7:0] | 0x00 | Digital mixer 2, channel 1 coefficient byte[15:8] |
| 0x1B | MIX2_CH1_BYT4[7:0] | 0x00 | Digital mixer 2, channel 1 coefficient byte[7:0] |
| 0x1C | MIX2_CH2_BYT1[7:0] | 0x7F | Digital mixer 2, channel 2 coefficient byte[31:24] |
| 0x1D | MIX2_CH2_BYT2[7:0] | 0xFF | Digital mixer 2, channel 2 coefficient byte[23:16] |
| 0x1E | MIX2_CH2_BYT3[7:0] | 0xFF | Digital mixer 2, channel 2 coefficient byte[15:8] |
| 0x1F | MIX2_CH2_BYT4[7:0] | 0xFF | Digital mixer 2, channel 2 coefficient byte[7:0] |
| 0x20 | MIX2_CH3_BYT1[7:0] | 0x00 | Digital mixer 2, channel 3 coefficient byte[31:24] |
| 0x21 | MIX2_CH3_BYT2[7:0] | 0x00 | Digital mixer 2, channel 3 coefficient byte[23:16] |
| 0x22 | MIX2_CH3_BYT3[7:0] | 0x00 | Digital mixer 2, channel 3 coefficient byte[15:8] |
| 0x23 | MIX2_CH3_BYT4[7:0] | 0x00 | Digital mixer 2, channel 3 coefficient byte[7:0] |
| 0x24 | MIX2_CH4_BYT1[7:0] | 0x00 | Digital mixer 2, channel 4 coefficient byte[31:24] |
| 0x25 | MIX2_CH4_BYT2[7:0] | 0x00 | Digital mixer 2, channel 4 coefficient byte[23:16] |
| 0x26 | MIX2_CH4_BYT3[7:0] | 0x00 | Digital mixer 2, channel 4 coefficient byte[15:8] |
| 0x27 | MIX2_CH4_BYT4[7:0] | 0x00 | Digital mixer 2, channel 4 coefficient byte[7:0] |
| 0x28 | MIX3_CH1_BYT1[7:0] | 0x00 | Digital mixer 3, channel 1 coefficient byte[31:24] |
| 0x29 | MIX3_CH1_BYT2[7:0] | 0x00 | Digital mixer 3, channel 1 coefficient byte[23:16] |
| 0x2A | MIX3_CH1_BYT3[7:0] | 0x00 | Digital mixer 3, channel 1 coefficient byte[15:8] |
| 0x2B | MIX3_CH1_BYT4[7:0] | 0x00 | Digital mixer 3, channel 1 coefficient byte[7:0] |

Table 8-189. Page 4 Programmable Coefficient Registers (continued)

| ADDRESS | ACRONYM | RESET VALUE | REGISTER DESCRIPTION |
|---------|--------------------|-------------|--|
| 0x2C | MIX3_CH2_BYT1[7:0] | 0x00 | Digital mixer 3, channel 2 coefficient byte[31:24] |
| 0x2D | MIX3_CH2_BYT2[7:0] | 0x00 | Digital mixer 3, channel 2 coefficient byte[23:16] |
| 0x2E | MIX3_CH2_BYT3[7:0] | 0x00 | Digital mixer 3, channel 2 coefficient byte[15:8] |
| 0x2F | MIX3_CH2_BYT4[7:0] | 0x00 | Digital mixer 3, channel 2 coefficient byte[7:0] |
| 0x30 | MIX3_CH3_BYT1[7:0] | 0x7F | Digital mixer 3, channel 3 coefficient byte[31:24] |
| 0x31 | MIX3_CH3_BYT2[7:0] | 0xFF | Digital mixer 3, channel 3 coefficient byte[23:16] |
| 0x32 | MIX3_CH3_BYT3[7:0] | 0xFF | Digital mixer 3, channel 3 coefficient byte[15:8] |
| 0x33 | MIX3_CH3_BYT4[7:0] | 0xFF | Digital mixer 3, channel 3 coefficient byte[7:0] |
| 0x34 | MIX3_CH4_BYT1[7:0] | 0x00 | Digital mixer 3, channel 4 coefficient byte[31:24] |
| 0x35 | MIX3_CH4_BYT2[7:0] | 0x00 | Digital mixer 3, channel 4 coefficient byte[23:16] |
| 0x36 | MIX3_CH4_BYT3[7:0] | 0x00 | Digital mixer 3, channel 4 coefficient byte[15:8] |
| 0x37 | MIX3_CH4_BYT4[7:0] | 0x00 | Digital mixer 3, channel 4 coefficient byte[7:0] |
| 0x38 | MIX4_CH1_BYT1[7:0] | 0x00 | Digital mixer 4, channel 1 coefficient byte[31:24] |
| 0x39 | MIX4_CH1_BYT2[7:0] | 0x00 | Digital mixer 4, channel 1 coefficient byte[23:16] |
| 0x3A | MIX4_CH1_BYT3[7:0] | 0x00 | Digital mixer 4, channel 1 coefficient byte[15:8] |
| 0x3B | MIX4_CH1_BYT4[7:0] | 0x00 | Digital mixer 4, channel 1 coefficient byte[7:0] |
| 0x3C | MIX4_CH2_BYT1[7:0] | 0x00 | Digital mixer 4, channel 2 coefficient byte[31:24] |
| 0x3D | MIX4_CH2_BYT2[7:0] | 0x00 | Digital mixer 4, channel 2 coefficient byte[23:16] |
| 0x3E | MIX4_CH2_BYT3[7:0] | 0x00 | Digital mixer 4, channel 2 coefficient byte[15:8] |
| 0x3F | MIX4_CH2_BYT4[7:0] | 0x00 | Digital mixer 4, channel 2 coefficient byte[7:0] |
| 0x40 | MIX4_CH3_BYT1[7:0] | 0x00 | Digital mixer 4, channel 3 coefficient byte[31:24] |
| 0x41 | MIX4_CH3_BYT2[7:0] | 0x00 | Digital mixer 4, channel 3 coefficient byte[23:16] |
| 0x42 | MIX4_CH3_BYT3[7:0] | 0x00 | Digital mixer 4, channel 3 coefficient byte[15:8] |
| 0x43 | MIX4_CH3_BYT4[7:0] | 0x00 | Digital mixer 4, channel 3 coefficient byte[7:0] |
| 0x44 | MIX4_CH4_BYT1[7:0] | 0x7F | Digital mixer 4, channel 4 coefficient byte[31:24] |
| 0x45 | MIX4_CH4_BYT2[7:0] | 0xFF | Digital mixer 4, channel 4 coefficient byte[23:16] |
| 0x46 | MIX4_CH4_BYT3[7:0] | 0xFF | Digital mixer 4, channel 4 coefficient byte[15:8] |
| 0x47 | MIX4_CH4_BYT4[7:0] | 0xFF | Digital mixer 4, channel 4 coefficient byte[7:0] |
| 0x48 | IIR_N0_BYT1[7:0] | 0x7F | Programmable first-order IIR, N0 coefficient byte[31:24] |
| 0x49 | IIR_N0_BYT2[7:0] | 0xFF | Programmable first-order IIR, N0 coefficient byte[23:16] |
| 0x4A | IIR_N0_BYT3[7:0] | 0xFF | Programmable first-order IIR, N0 coefficient byte[15:8] |
| 0x4B | IIR_N0_BYT4[7:0] | 0xFF | Programmable first-order IIR, N0 coefficient byte[7:0] |
| 0x4C | IIR_N1_BYT1[7:0] | 0x00 | Programmable first-order IIR, N1 coefficient byte[31:24] |
| 0x4D | IIR_N1_BYT2[7:0] | 0x00 | Programmable first-order IIR, N1 coefficient byte[23:16] |
| 0x4E | IIR_N1_BYT3[7:0] | 0x00 | Programmable first-order IIR, N1 coefficient byte[15:8] |
| 0x4F | IIR_N1_BYT4[7:0] | 0x00 | Programmable first-order IIR, N1 coefficient byte[7:0] |
| 0x50 | IIR_D1_BYT1[7:0] | 0x00 | Programmable first-order IIR, D1 coefficient byte[31:24] |
| 0x51 | IIR_D1_BYT2[7:0] | 0x00 | Programmable first-order IIR, D1 coefficient byte[23:16] |
| 0x52 | IIR_D1_BYT3[7:0] | 0x00 | Programmable first-order IIR, D1 coefficient byte[15:8] |
| 0x53 | IIR_D1_BYT4[7:0] | 0x00 | Programmable first-order IIR, D1 coefficient byte[7:0] |

9 Application and Implementation

Note

Information in the following applications sections is not part of the TI component specification, and TI does not warrant its accuracy or completeness. TI's customers are responsible for determining suitability of components for their purposes, as well as validating and testing their design implementation to confirm system functionality.

9.1 Application Information

The PCM6480-Q1 is a multichannel, automotive qualified audio analog-to-digital converter (ADC) that supports output sample rates of up to 768 kHz. The PCM6480-Q1 is a high-performance audio converter that supports simultaneous sampling of up to a 4-channel analog microphone or a line input along with up to a 4-channel digital pulse density-modulation (PDM) microphone input. The device integration enables both an in-cabin active noise cancellation (ANC) and a voice recognition (VR) application in a very efficient manner by using the analog and digital microphones input sampling simultaneously. The PCM6480-Q1 is intended for automotive applications such as vehicle cabin active noise cancellation, hands-free in-vehicle communication, emergency call, and multi-media applications. This device integrates a host of features to reduce cost, board space, and power consumption in space-constrained automotive subsystem designs.

Communication to the PCM6480-Q1 for configuration of the control registers is supported using an I²C or SPI interface. The device supports a highly flexible audio serial interface (TDM, I²S, or LJ) to transmit audio data seamlessly in the system across devices.

9.2 Typical Application

9.2.1 Four-Channel Analog Microphone and Four-Channel PDM Microphone Simultaneous Recording Using the PCM6480-Q1

Figure 9-1 shows a typical configuration of the PCM6480-Q1 for an application using four analog microphones and four digital PDM microphones for simultaneous recording operation with an I²C control interface and the TDM audio data slave interface.

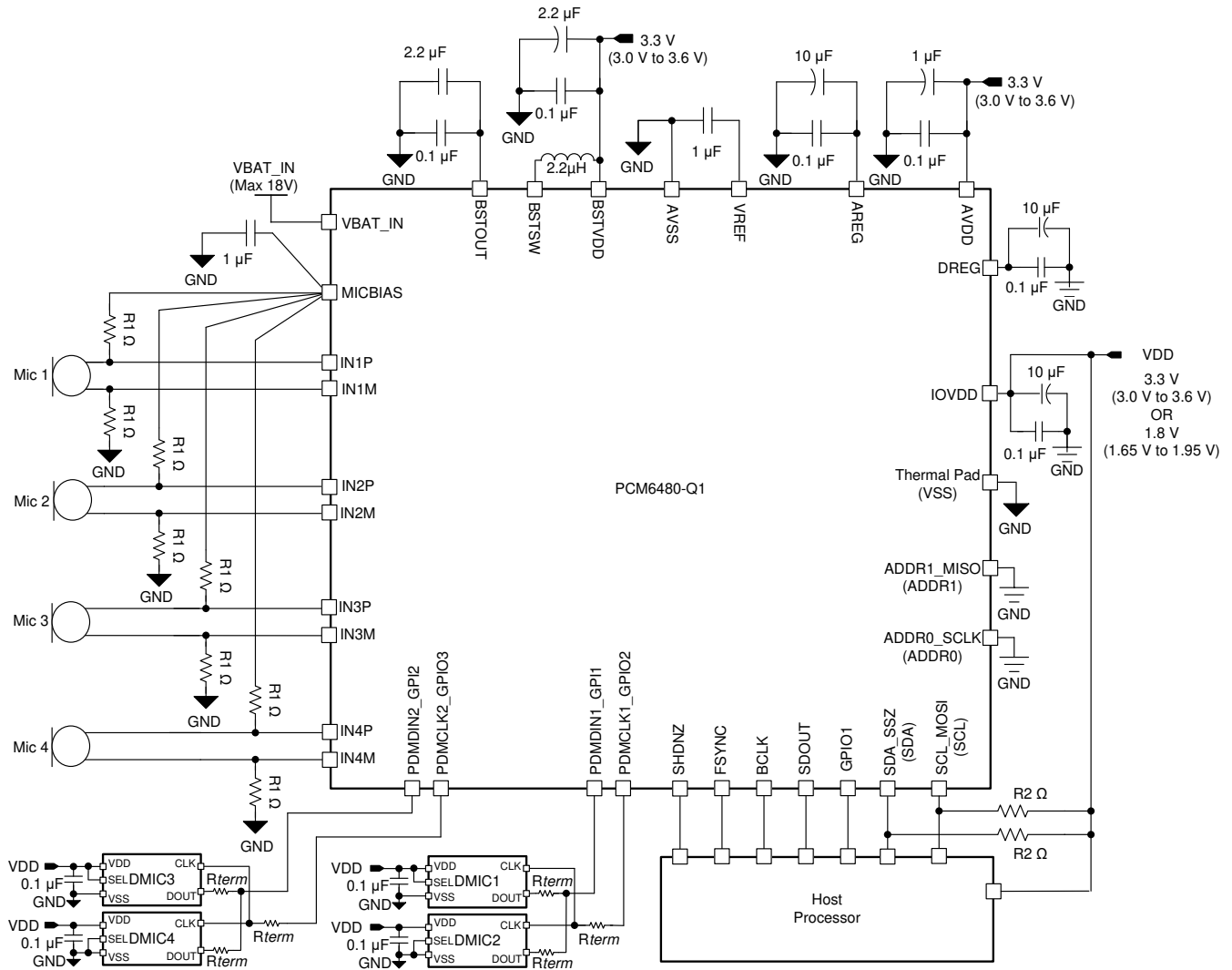

Figure 9-1. Four-Channel Analog Microphone and Four-Channel Digital Microphone Simultaneous Recording

9.2.1.1 Design Requirements

Table 9-1 lists the design parameters for this application.

Table 9-1. Design Parameters

| KEY PARAMETER | SPECIFICATION |
|-------------------------|---|
| AVDD, BSTVDD | 3.3 V |
| AVDD supply current | 28 mA (PLL on, all eight-channel record, $f_s = 44.1$ kHz) |
| IOVDD | 1.8 V or 3.3 V |
| Maximum MICBIAS current | < 28 mA (MICBIAS voltage = 8 V, microphone impedance = 680 Ω and $R1 = 340$ Ω) |

9.2.1.2 Detailed Design Procedure

This section describes the necessary steps to configure the PCM6480-Q1 for this specific application. The following steps give a sequence of items that must be executed in the time between powering the device up and reading data from the device or transitioning from one mode to other mode of operation.

1. **Apply Power to Device:**
 - a. Power up the IOVDD, AVDD, and BSTVDD power supplies, keeping the SHDNZ pin voltage low
 - b. The device now goes into hardware shutdown mode (ultra-low-power mode < 1 μ A)
2. **Transition From Hardware Shutdown Mode to Sleep Mode (or Software Shutdown Mode):**
 - a. Release SHDNZ only when the IOVDD, AVDD, and BSTVDD power supplies settle to the steady-state operating voltage
 - b. Wait for at least 1 ms to allow the device to initialize the internal registers
 - c. The device now goes into sleep mode (low-power mode < 20 μ A)
3. **Transition From Sleep Mode to Active Mode Whenever Required for the Record Operation:**
 - a. Wake-up the device by writing P0_R2 to disable sleep mode
 - b. Wait for at least 1ms to allow the device internal wake-up sequence to complete
 - c. *Override the default configuration registers or programmable coefficients value as required (optional)*
 - d. Enable all desired input channels by writing P0_R115
 - e. Enable all desired audio serial interface output channels by writing P0_R116
 - f. Power-up the ADC, MICBIAS, and PLL by writing P0_R117
 - g. Apply FSYNC and BCLK with the desired output sample rates and the BCLK to FSYNC ratio

This specific step can be done at any point in the sequence after step a

See the [Phase-Locked Loop \(PLL\) and Clock Generation](#) section for the supported sample rates and the BCLK to FSYNC ratio

- h. The device recording data are now sent to the host processor via the TDM audio serial data bus
 - i. Wait for at least 10 ms to allow the MICBIAS to power up
 - j. Enable the fault diagnostics for all desired input channels by writing P0_R100
4. **Transition From Active Mode to Sleep Mode (Again) as Required in the System Low Power:**
 - a. Disable the fault diagnostics for all desired input channels by writing P0_R100
 - b. Go to sleep mode by writing P0_R2 to enable sleep mode
 - c. Wait at least 20 ms to allow the volume to gradually ramp down and for all blocks to power down
 - d. Read P0_R119 to check the device shutdown and sleep mode status
 - e. If the device P0_R119_D7 status bit is 1'b1, then stop FSYNC and BCLK in the system
 - f. The device now goes into sleep mode (low-power mode < 20 μ A) and retains all register values
5. **Transition From Sleep Mode to Active Mode (Again) as Required for the Record Operation:**
 - a. Wake-up the device by writing P0_R2 to disable sleep mode
 - b. Wait for at least 1 ms to allow the device internal wake-up sequence to complete
 - c. Apply FSYNC and BCLK with the desired output sample rates and BCLK to FSYNC ratio

- d. The device recording data are now sent to the host processor via the TDM audio serial data bus
- e. Wait for at least 10 ms to allow the MICBIAS to power up
- f. Enable the fault diagnostics for all desired input channels by writing P0_R100

6. Repeat Step 4 and Step 5 as Required for Mode Transitions

7. Assert the SHDNZ Pin Low to Enter Hardware Shutdown Mode (Again) at Any Time

8. Follow Step 2 Onwards to Exit Hardware Shutdown Mode (Again)

9.2.1.2.1 Example Device Register Configuration Script for EVM Setup

This section provides a typical EVM I²C register control script that shows how to set up the PCM6480-Q1 in a 4-channel digital PDM input and a 4-channel analog microphone record mode with differential inputs.

```
#
# Key: w 98 XX YY ==> write to I2C address 0x98, to register 0xXX, data 0xYY
#       # ==> comment delimiter
#
# The following list gives an example sequence of items that must be executed in the time
# between powering the device up and reading data from the device. Note that there are
# other valid sequences depending on which features are used.
#
# Refer to the PCM6xx0-Q1 EVM user guide for key jumper settings and audio connections:
#
# 4-channel differential analog input : INP1/INM1 - Ch1, INP2/INM2 - Ch2, INP3/INM3 - Ch3 and INP4/
INM4 - Ch4
# High swing mode enabled
# 4-channel digital PDM input : PDMDIN1_GPI1 - Ch5 and Ch6 and PDMDIN2_GPI2 - Ch7 and Ch8
# FSYNC = 44.1 kHz (Output Data Sample Rate), BCLK = 11.2896 MHz (BCLK/FSYNC = 256)
#####
#
# Power up IOVDD, AVDD and BSTVDD power supplies keeping SHDNZ pin voltage LOW
# Wait for IOVDD, AVDD and BSTVDD power supplies to settle to steady state operating voltage range.
# Release SHDNZ to HIGH.
# Wait for 1ms.
#
# Wake-up device by I2C write into P0_R2 using internal AREG
w 90 02 81
#
# Powerdown MICBIAS and ADC channels on fault detection (overtemperature, and so forth)
w 90 28 10
#
# Configure channel 1 DC-coupled, differential microphone input with high-swing mode
w 90 3C 18
#
# Configure channel 2 DC-coupled, differential microphone input with high-swing mode
w 90 41 18
#
# Configure channel 3 DC-coupled, differential microphone input with high-swing mode
w 90 46 18
#
# Configure channel 4 DC-coupled, differential microphone input with high-swing mode
w 90 4B 18
#
# Configure CH5_INSRC as Digital PDM Input by I2C write into P0_R80
w 98 50 40
#
# Configure CH6_INSRC as Digital PDM Input by I2C write into P0_R85
w 98 55 40
#
# Configure CH7_INSRC as Digital PDM Input by I2C write into P0_R90
w 98 5A 40
#
# Configure CH8_INSRC as Digital PDM Input by I2C write into P0_R95
w 98 5F 40
#
# Configure PDMCLK1_GPIO2 as PDMCLK by I2C write into P0_R34
w 98 22 41
#
# Configure PDMCLK1_GPIO3 as PDMCLK by I2C write into P0_R35
w 98 23 41
#
# Configure PDMDIN1_GPI1 as PDMDIN1 by I2C write into P0_R36
```

```

w 98 24 E0
#
# Configure PDMDIN2_GPI2 as PDMDIN2 by I2C write into P0_R37
w 98 25 F0
#
# Enable input channel 1 to channel 4 by I2C write into P0_R115
w 90 73 FF
#
# Enable ASI output channel 1 to channel 4 slots by I2C write into P0_R116
w 90 74 FF
#
# Power-up ADC, MICBIAS and PLL by I2C write into P0_R117
w 90 75 E0
#
# Apply FSYNC = 44.1 kHz and BCLK = 11.2896 MHz and
# Start recording data by host on ASI bus with TDM protocol 32-bit channel word length
#
# Wait for 10 ms.
# Enable diagnostics for channel 1 to channel 4 by I2C write into P0_R100
w 90 64 F0
#

```

9.2.1.3 Application Curves

at $T_A = 25^\circ\text{C}$, $AVDD = 3.3\text{ V}$, $IOVDD = 3.3\text{ V}$, $BSTVDD = 3.3\text{ V}$, $f_{IN} = 1\text{-kHz}$ sinusoidal signal, $f_S = 44.1\text{ kHz}$, 32-bit audio data, $BCLK = 256 \times f_S$, TDM slave mode, PLL on, channel gain = 0 dB, linear phase decimation filter, and MICBIAS programmed voltage = 8 V (unless otherwise noted); all measurements are done on the EVM by feeding the device analog input and PDM digital input signal using audio precision, however, in the real system application, the device performance is expected to be limited by single-bit PDM modulator digital microphone output performance; all performance measurements are done with a 20-kHz, low-pass filter and an A-weighted filter (unless otherwise noted)

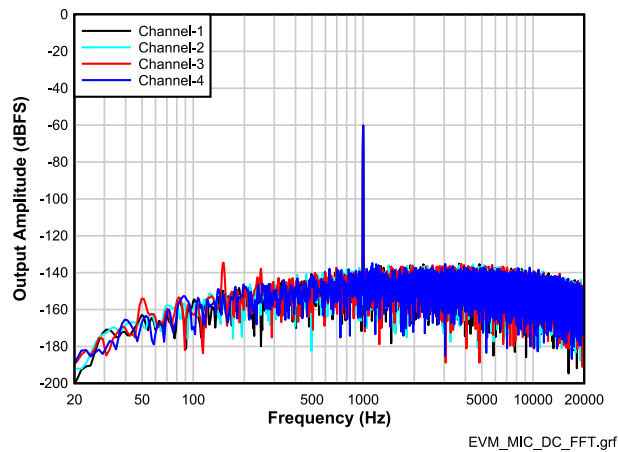

DC-coupled differential microphone input with DC common-mode $1N \times P = \sim 6\text{ V}$ and $1N \times M = \sim 2\text{ V}$, high swing mode enabled, measured using an external audio input source

Figure 9-2. Analog Inputs FFT With a -60-dBr Input

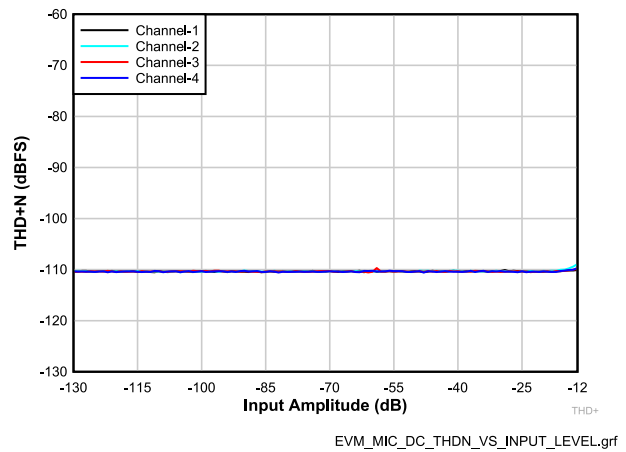

DC-coupled differential microphone input with DC common-mode $1N \times P = \sim 6\text{ V}$ and $1N \times M = \sim 2\text{ V}$, high swing mode enabled, measured using an external audio input source

Figure 9-3. Analog Inputs THD+N vs Input Amplitude

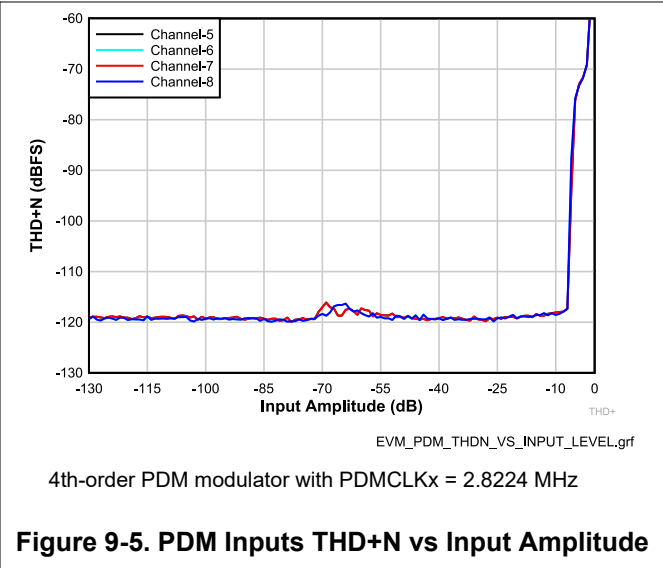
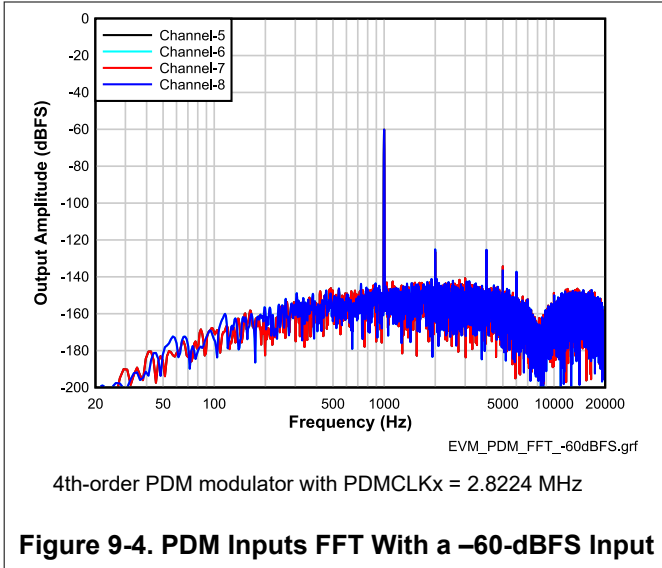

9.3 What To Do and What Not To Do

In master mode operation with I²S or LJ format, the device generates FSYNC half a cycle earlier than the normal protocol timing behavior expected. This timing behavior can still function for most of the system, however for further details and a suggested workaround for this weakness, see the [Configuring and Operating TLV320ADCx140 as Audio Bus Master application report](#).

The automatic gain controller (AGC) feature has some limitation when using sampling rates lower than 44.1 kHz. For further details about this limitation, see the [Using the Automatic Gain Controller in PCM6xx0-Q1 application report](#).

For I²C operation, if the ADDR0_SCLK pin is tied high, then the I²C bus must remain idle (which means the SDA_SSZ and SCL_MOSI pins must be high) when the SHDNZ pin is released from low to high.

10 Power Supply Recommendations

The power-supply sequence between the IOVDD and AVDD rails can be applied in any order. However, keep the SHDNZ pin low until the IOVDD supply voltage settles to a stable and supported operating voltage range. After the IOVDD and AVDD supplies are stable, set the SHDNZ pin high to initialize the device. BSTVDD can be either applied along with AVDD or later but before turning on the MICBIAS. [Figure 10-1](#) shows the power supply sequencing requirements.

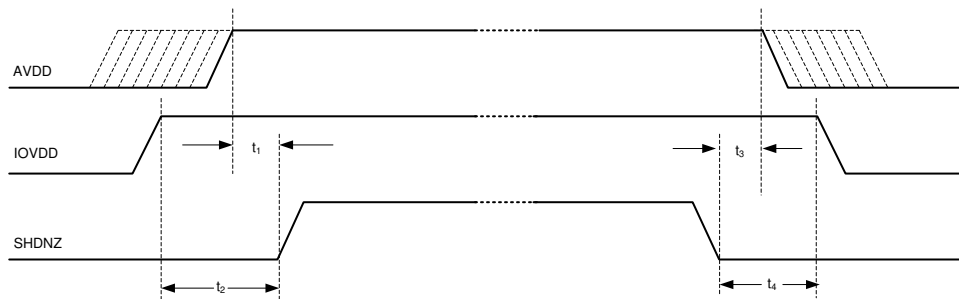

Figure 10-1. Power-Supply Sequencing Requirement

For the supply power-up requirement, t_1 and t_2 must be at least 100 μs . For the supply power-down requirement, t_3 and t_4 must be at least 10 ms. This time allows the device to ramp down the volume on the record data, and power down the analog and digital blocks, and lastly put the device into hardware shutdown mode. The device can also be immediately put into hardware shutdown mode from active mode if SHDNZ_CFG[1:0] is set to 2'b00 using the P0_R5_D[3:2] bits. In that case, t_3 and t_4 are required to be at least 100 μs .

Make sure that the supply ramp rate is slower than 1 V/ μs and that the wait time between a power-down and a power-up event is at least 100 ms. For a supply ramp rate slower than 0.1 V/ms, the host device must apply a software reset as the first transaction before configuring the device.

After releasing SHDNZ, or after a software reset, delay any additional I²C or SPI transactions to the device for at least 2 ms to allow the device to initialize the internal registers. See the [Device Functional Modes](#) section to operate the device in various modes after the device power supplies are settled to the recommended operating voltage levels.

11 Layout

11.1 Layout Guidelines

Each system design and printed circuit board (PCB) layout is unique. The layout must be carefully reviewed in the context of a specific PCB design. However, the following guidelines can optimize the device performance:

- Connect the thermal pad to ground. Use a via pattern to connect the device thermal pad, the area directly under the device, to the ground planes. This connection helps dissipate heat from the device.
- The decoupling capacitors for the power supplies must be placed close to the device pins.
- The supply decoupling capacitors used must be of a ceramic type with low ESR.
- The boost converter inductor and decoupling capacitors for the power supplies must be placed close to the device pins.
- Route analog differential audio signals differentially on the PCB for better noise immunity. Avoid crossing digital and analog signals to avoid undesirable crosstalk.
- The device internal voltage references must be filtered using external capacitors. Place the filter capacitors near the VREF pin for optimal performance.
- Directly tap the MICBIAS pin to avoid common impedance when routing the biasing or supply for multiple microphones to avoid coupling across microphones.
- Place the MICBIAS capacitor (with low equivalent series resistance) close to the device with minimal trace impedance.
- Use MICBIAS and BSTOUT capacitors with a high voltage rating (> 25V) to support higher voltage MICBIAS operation.
- An external circuit must be used to suppress or filter the amount of high-frequency electromagnetic interference (EMI) noise found in the microphone input path resulting from long cables (if used) in the system.
- Use ground planes to provide the lowest impedance for power and signal current between the device and the decoupling capacitors. Treat the area directly under the device as a central ground area for the device, and all device grounds must be connected directly to that area.

11.2 Layout Example

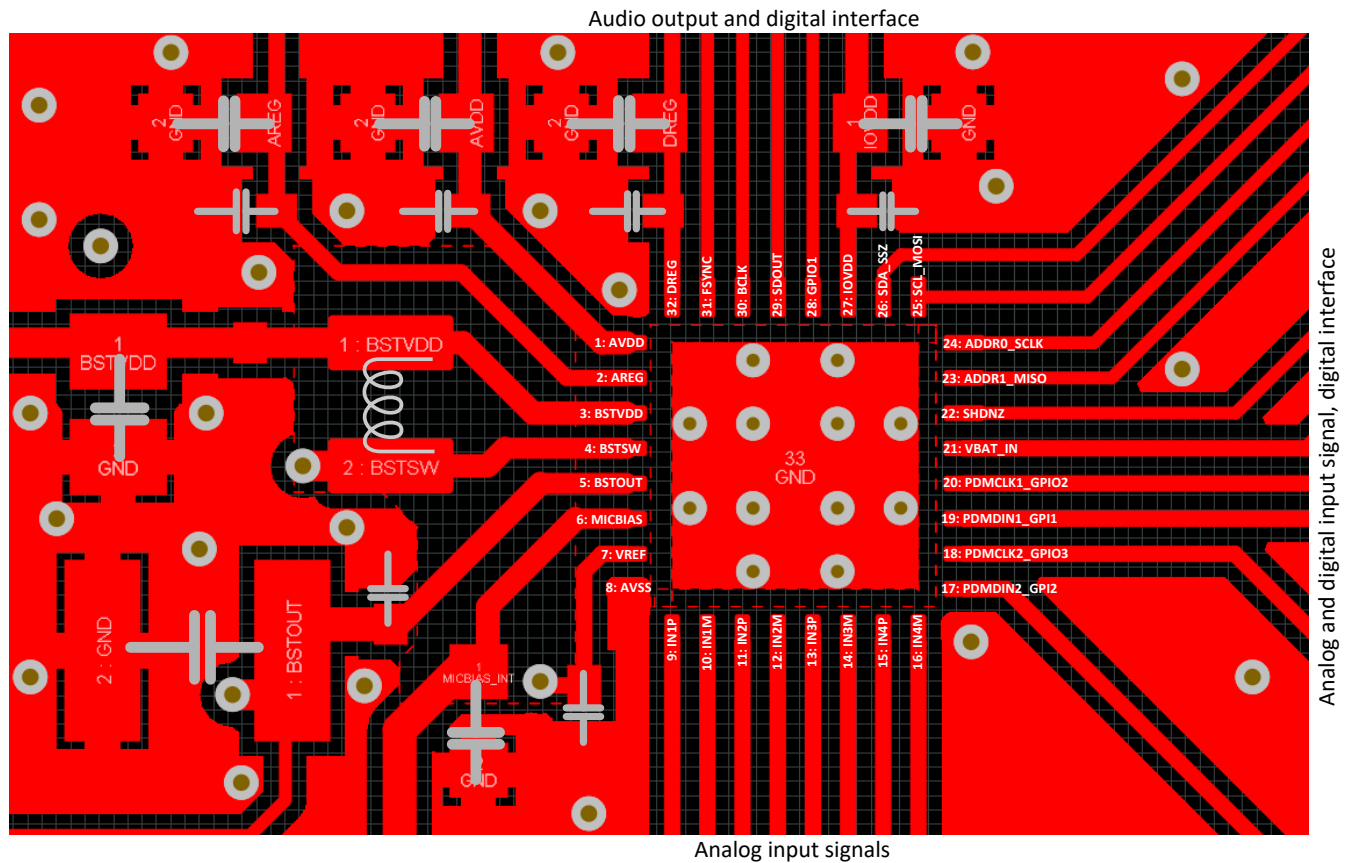

Figure 11-1. Layout Example of the PCM6480-Q1

12 Device and Documentation Support

12.1 Device Support

12.1.1 Development Support

[PurePath™ console graphical development suite](#)

12.2 Documentation Support

12.2.1 Related Documentation

For related documentation see the following:

- Texas Instruments, [Multiple PCM6xx0-Q1 Devices With Shared TDM and I²C Bus application report](#)
- Texas Instruments, [PCM6xx0-Q1 Programmable Biquad Filter Configuration and Applications application report](#)
- Texas Instruments, [PCM6xx0-Q1 Sampling Rates and Programmable Processing Blocks Supported application report](#)
- Texas Instruments, [PCM6xx0-Q1 Integrated Analog Anti-Aliasing Filter and Flexible Digital Filter application report](#)
- Texas Instruments, [Configuring and Operating TLV320ADCx140 as Audio Bus Master application report](#)
- Texas Instruments, [Using the Automatic Gain Controller in PCM6xx0-Q1 application report](#)
- Texas Instruments, [PCM6xx0-Q1 Fault Diagnostics Features application report](#)
- Texas Instruments, [Scalable Automotive Audio Solutions Using the PCM6xx0-Q1 Family of Products application report](#)
- Texas Instruments, [PCM6xx0-Q1 Use-Case Scenarios in Automotive Audio Applications application report](#)
- Texas Instruments, [PCM6xx0-Q1 AC-Coupled External Resistor Calculator](#)
- Texas Instruments, [PCM6xx0-Q1 SIMULATION IBIS Models](#)
- Texas Instruments, [PCM6xx0Q1EVM-PDK Evaluation Module user's guide](#)
- Texas Instruments, [PurePath™ Console Graphical Development Suite for Audio System Design and Development development suite](#)

12.3 Receiving Notification of Documentation Updates

To receive notification of documentation updates, navigate to the device product folder on [ti.com](#). Click on [Subscribe to updates](#) to register and receive a weekly digest of any product information that has changed. For change details, review the revision history included in any revised document.

12.4 Support Resources

[TI E2E™ support forums](#) are an engineer's go-to source for fast, verified answers and design help — straight from the experts. Search existing answers or ask your own question to get the quick design help you need.

Linked content is provided "AS IS" by the respective contributors. They do not constitute TI specifications and do not necessarily reflect TI's views; see TI's [Terms of Use](#).

12.5 Trademarks

PurePath™ and TI E2E™ are trademarks of Texas Instruments.

All trademarks are the property of their respective owners.

12.6 Electrostatic Discharge Caution



This integrated circuit can be damaged by ESD. Texas Instruments recommends that all integrated circuits be handled with appropriate precautions. Failure to observe proper handling and installation procedures can cause damage.

ESD damage can range from subtle performance degradation to complete device failure. Precision integrated circuits may be more susceptible to damage because very small parametric changes could cause the device not to meet its published specifications.

12.7 Glossary

[TI Glossary](#) This glossary lists and explains terms, acronyms, and definitions.

13 Mechanical, Packaging, and Orderable Information

The following pages include mechanical, packaging, and orderable information. This information is the most current data available for the designated devices. This data is subject to change without notice and revision of this document. For browser-based versions of this data sheet, refer to the left-hand navigation.

PACKAGING INFORMATION

| Orderable Device | Status (1) | Package Type | Package Drawing | Pins | Package Qty | Eco Plan (2) | Lead finish/ Ball material (6) | MSL Peak Temp (3) | Op Temp (°C) | Device Marking (4/5) | Samples |
|------------------|---------------|--------------|--------------------|------|----------------|-----------------|--------------------------------------|----------------------|--------------|-------------------------|---------|
| PCM6480QRTVRQ1 | ACTIVE | WQFN | RTV | 32 | 3000 | RoHS & Green | NIPDAU | Level-2-260C-1 YEAR | -40 to 125 | PCM6480 | Samples |

(1) The marketing status values are defined as follows:

ACTIVE: Product device recommended for new designs.

LIFEBUY: TI has announced that the device will be discontinued, and a lifetime-buy period is in effect.

NRND: Not recommended for new designs. Device is in production to support existing customers, but TI does not recommend using this part in a new design.

PREVIEW: Device has been announced but is not in production. Samples may or may not be available.

OBSOLETE: TI has discontinued the production of the device.

(2) **RoHS:** TI defines "RoHS" to mean semiconductor products that are compliant with the current EU RoHS requirements for all 10 RoHS substances, including the requirement that RoHS substance do not exceed 0.1% by weight in homogeneous materials. Where designed to be soldered at high temperatures, "RoHS" products are suitable for use in specified lead-free processes. TI may reference these types of products as "Pb-Free".

RoHS Exempt: TI defines "RoHS Exempt" to mean products that contain lead but are compliant with EU RoHS pursuant to a specific EU RoHS exemption.

Green: TI defines "Green" to mean the content of Chlorine (Cl) and Bromine (Br) based flame retardants meet JS709B low halogen requirements of <=1000ppm threshold. Antimony trioxide based flame retardants must also meet the <=1000ppm threshold requirement.

(3) MSL, Peak Temp. - The Moisture Sensitivity Level rating according to the JEDEC industry standard classifications, and peak solder temperature.

(4) There may be additional marking, which relates to the logo, the lot trace code information, or the environmental category on the device.

(5) Multiple Device Markings will be inside parentheses. Only one Device Marking contained in parentheses and separated by a "-" will appear on a device. If a line is indented then it is a continuation of the previous line and the two combined represent the entire Device Marking for that device.

(6) Lead finish/Ball material - Orderable Devices may have multiple material finish options. Finish options are separated by a vertical ruled line. Lead finish/Ball material values may wrap to two lines if the finish value exceeds the maximum column width.

Important Information and Disclaimer: The information provided on this page represents TI's knowledge and belief as of the date that it is provided. TI bases its knowledge and belief on information provided by third parties, and makes no representation or warranty as to the accuracy of such information. Efforts are underway to better integrate information from third parties. TI has taken and continues to take reasonable steps to provide representative and accurate information but may not have conducted destructive testing or chemical analysis on incoming materials and chemicals. TI and TI suppliers consider certain information to be proprietary, and thus CAS numbers and other limited information may not be available for release.

In no event shall TI's liability arising out of such information exceed the total purchase price of the TI part(s) at issue in this document sold by TI to Customer on an annual basis.

TAPE AND REEL INFORMATION

QUADRANT ASSIGNMENTS FOR PIN 1 ORIENTATION IN TAPE

*All dimensions are nominal

| Device | Package Type | Package Drawing | Pins | SPQ | Reel Diameter (mm) | Reel Width W1 (mm) | A0 (mm) | B0 (mm) | K0 (mm) | P1 (mm) | W (mm) | Pin1 Quadrant |
|----------------|--------------|-----------------|------|------|--------------------|--------------------|---------|---------|---------|---------|--------|---------------|
| PCM6480QRTVRQ1 | WQFN | RTV | 32 | 3000 | 330.0 | 12.4 | 5.3 | 5.3 | 1.1 | 8.0 | 12.0 | Q2 |

TAPE AND REEL BOX DIMENSIONS

*All dimensions are nominal

| Device | Package Type | Package Drawing | Pins | SPQ | Length (mm) | Width (mm) | Height (mm) |
|----------------|--------------|-----------------|------|------|-------------|------------|-------------|
| PCM6480QRTVRQ1 | WQFN | RTV | 32 | 3000 | 367.0 | 367.0 | 35.0 |

RTV (S-PWQFN-N32)

PLASTIC QUAD FLATPACK NO-LEAD

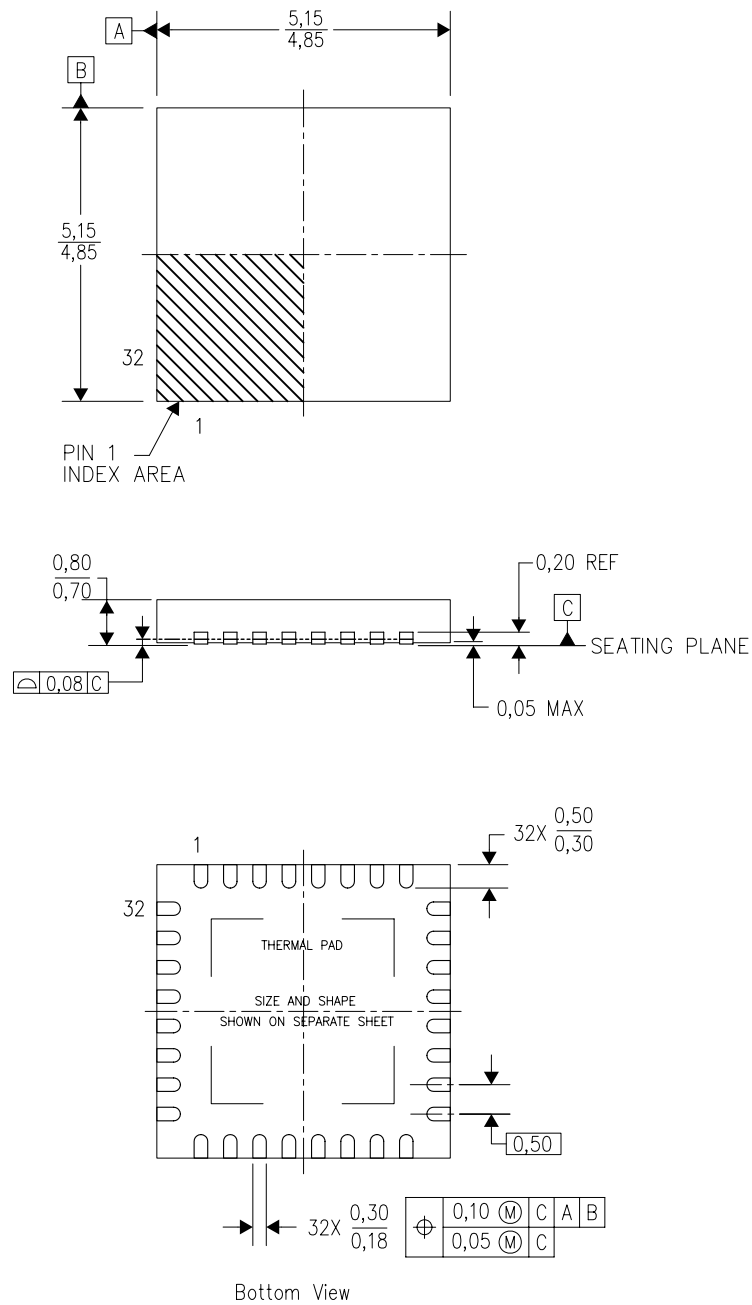

4206245/C 10/11

- NOTES:
- A. All linear dimensions are in millimeters. Dimensioning and tolerancing per ASME Y14.5-1994.
 - B. This drawing is subject to change without notice.
 - C. Quad Flatpack, No-Leads (QFN) package configuration.
 - D. The package thermal pad must be soldered to the board for thermal and mechanical performance.
 - E. See the additional figure in the Product Data Sheet for details regarding the exposed thermal pad features and dimensions.
 - F. Falls within JEDEC MO-220.

IMPORTANT NOTICE AND DISCLAIMER

TI PROVIDES TECHNICAL AND RELIABILITY DATA (INCLUDING DATA SHEETS), DESIGN RESOURCES (INCLUDING REFERENCE DESIGNS), APPLICATION OR OTHER DESIGN ADVICE, WEB TOOLS, SAFETY INFORMATION, AND OTHER RESOURCES "AS IS" AND WITH ALL FAULTS, AND DISCLAIMS ALL WARRANTIES, EXPRESS AND IMPLIED, INCLUDING WITHOUT LIMITATION ANY IMPLIED WARRANTIES OF MERCHANTABILITY, FITNESS FOR A PARTICULAR PURPOSE OR NON-INFRINGEMENT OF THIRD PARTY INTELLECTUAL PROPERTY RIGHTS.

These resources are intended for skilled developers designing with TI products. You are solely responsible for (1) selecting the appropriate TI products for your application, (2) designing, validating and testing your application, and (3) ensuring your application meets applicable standards, and any other safety, security, regulatory or other requirements.

These resources are subject to change without notice. TI grants you permission to use these resources only for development of an application that uses the TI products described in the resource. Other reproduction and display of these resources is prohibited. No license is granted to any other TI intellectual property right or to any third party intellectual property right. TI disclaims responsibility for, and you will fully indemnify TI and its representatives against, any claims, damages, costs, losses, and liabilities arising out of your use of these resources.

TI's products are provided subject to [TI's Terms of Sale](#) or other applicable terms available either on ti.com or provided in conjunction with such TI products. TI's provision of these resources does not expand or otherwise alter TI's applicable warranties or warranty disclaimers for TI products.

TI objects to and rejects any additional or different terms you may have proposed.

Mailing Address: Texas Instruments, Post Office Box 655303, Dallas, Texas 75265
Copyright © 2022, Texas Instruments Incorporated