

PART NAME

DIN RAIL / PANEL MOUNT BOX

PART No.

DB-4713

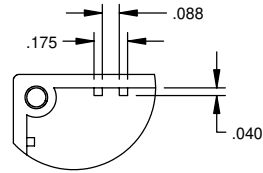

DETAIL B

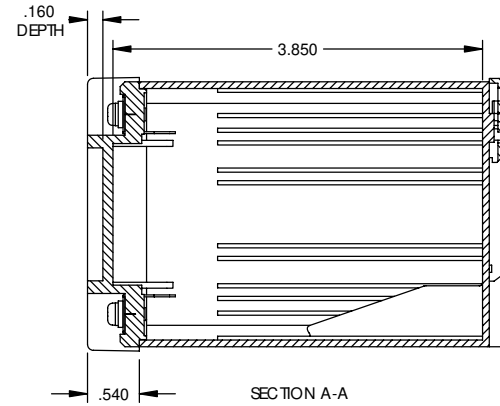
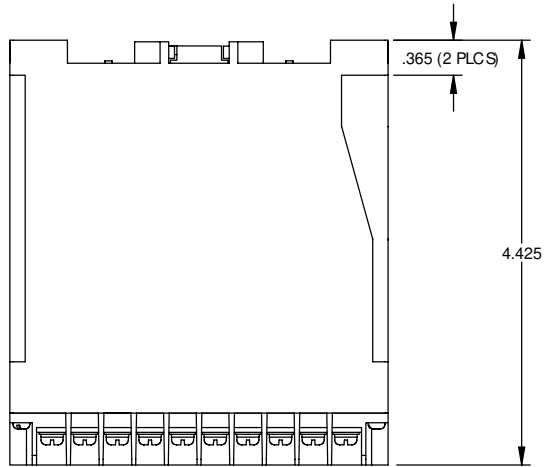
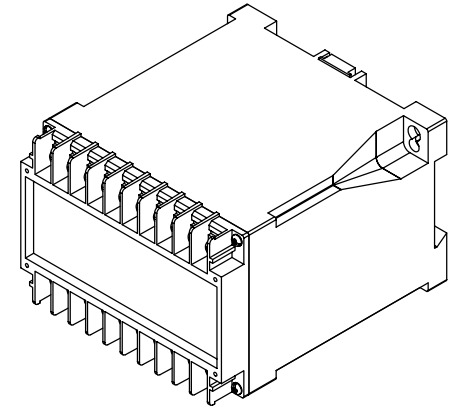

SECTION A-A

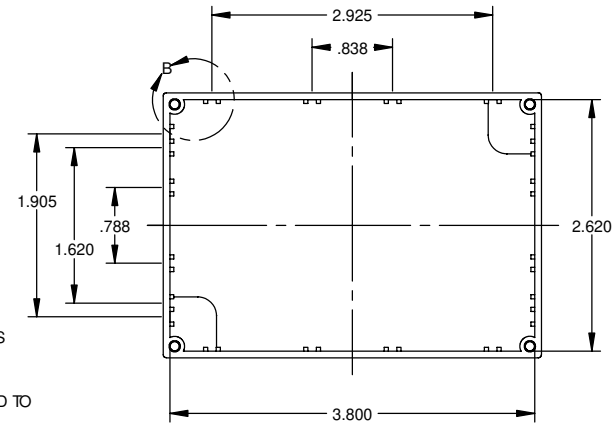
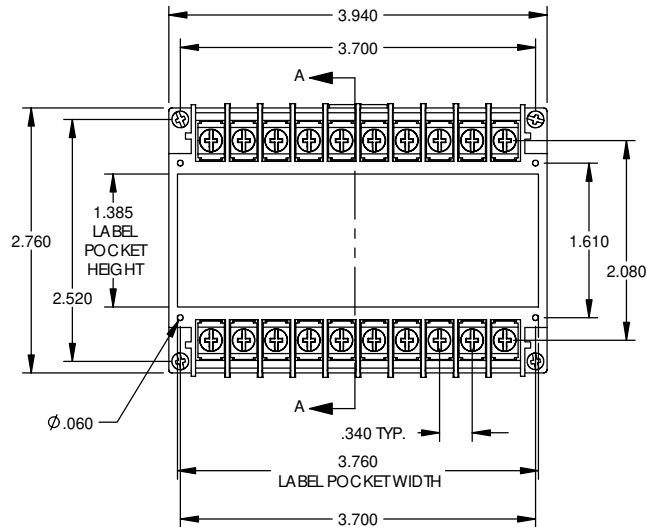

MATERIAL: UL94V-0 RATED ABS

FINISH: LIGHT GRAY

FOUR (4) M3 SCREWS SUPPLIED TO ATTACH FRONT PANEL

ALL DIMENSIONS HAVE A ±.015 TOLERANCE UNLESS OTHERWISE SPECIFIED

ALL CONTACTS ARE TIN PLATED BRASS RATED AT 10 AMPS