

4-1971905-6 ✓ ACTIVE



## GRACE INERTIA 3.3

TE Internal #: 4-1971905-6

Rectangular Power Connectors, Housing, Plug, Wire-to-Board, 12 Position, 3.3 mm [.129 in] Centerline, Wire & Cable, UL 94V-0, GRACE INERTIA 3.3

[View on TE.com >](#)

Connectors > Power Connectors > Rectangular Power > Rectangular Power Connectors > Glow Wire GRACE INERTIA Plug

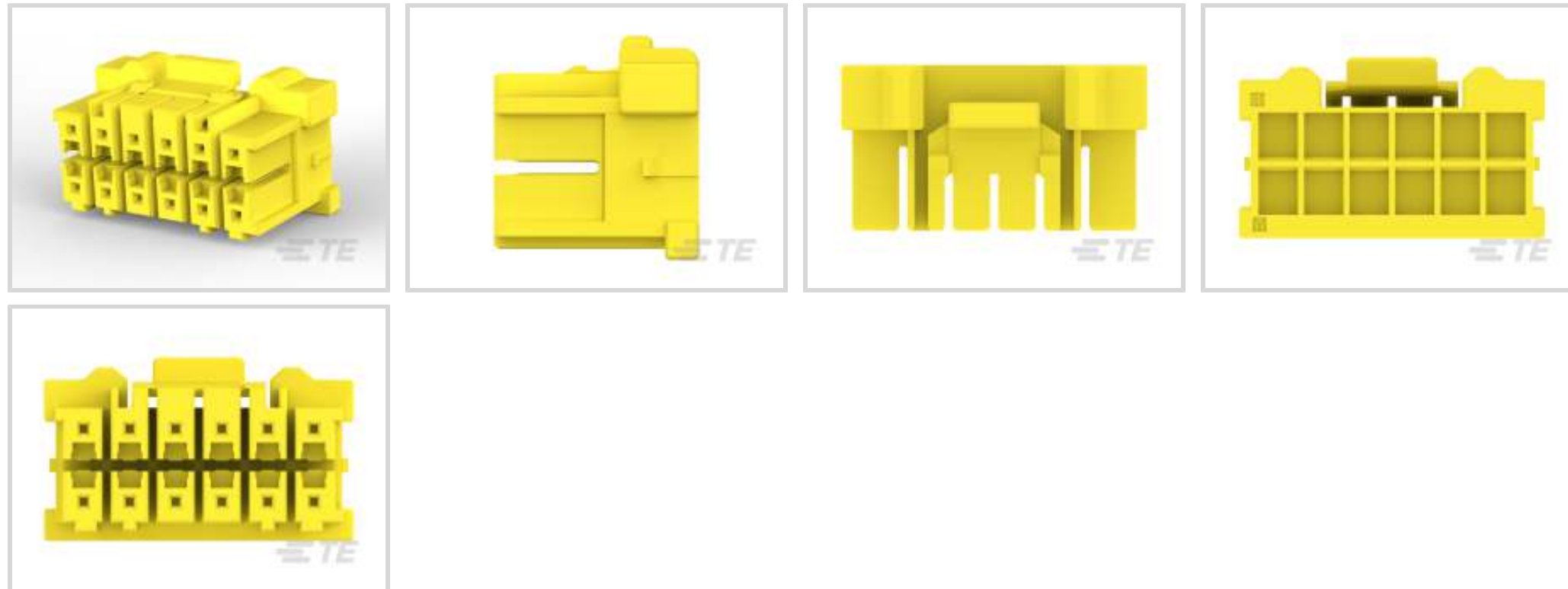

Rectangular Power Connector Type: **Housing**

Connector & Housing Type: **Plug**

Connector System: **Wire-to-Board**

Number of Positions: **12**

Centerline (Pitch): **3.3 mm [.129 in]**

[All Glow Wire GRACE INERTIA Plug \(78\)](#)

## Features

### Product Type Features

Rectangular Power Connector Type	Housing
Connector & Housing Type	Plug
Connector System	Wire-to-Board
Sealable	No
Connector & Contact Terminates To	Wire & Cable

### Configuration Features

Number of Positions	12
Number of Power Positions	12
Number of Signal Positions	12
Number of Rows	2

### Electrical Characteristics

Operating Voltage	250 VDC
-------------------	---------



### Body Features

Connector & Keying Code	D
-------------------------	---

### Contact Features

Contact Mating Area Plating Material	Tin
Contact Base Material	Copper Alloy
Contact Current Rating (Max)	4 A
Contact Retention Within Housing	With
Contact Type	Receptacle
Contact Mating Area Plating Material Thickness	2 $\mu\text{m}$ [78.73 $\mu\text{in}$ ]

### Termination Features

Termination Method to Wire & Cable	Crimp
------------------------------------	-------

### Mechanical Attachment

Strain Relief	Without
Mating Alignment Type	Keyed
Mating Retention	With
Mating Alignment	With
Panel Mount Feature	Without
PCB Mount Retention	Without
Mating Retention Type	Latch, Locking Latch
Connector Mounting Type	Cable Mount (Free-Hanging)

### Housing Features

Centerline (Pitch)	3.3 mm[.129 in]
Housing Color	Yellow
Housing Material	PA 66 GF

### Dimensions

Connector Height	12.4 mm[.488 in]
Product Length	25.5 mm[1 in]
Wire Size	414.44 – 1045.97 CMA
Row-to-Row Spacing	5.2 mm[.205 in]

### Usage Conditions

Operating Temperature Range	-30 – 105 $^{\circ}\text{C}$ [-22 – 221 $^{\circ}\text{F}$ ]
-----------------------------	--

### Operation/Application



Circuit Application	Power & Signal
---------------------	----------------

### Industry Standards

UL Flammability Rating	UL 94V-0
Glow Wire Rating	GWT 750°C (Without Flame)

### Packaging Features

Packaging Quantity	200
Packaging Method	Bag

### Product Compliance

[For compliance documentation, visit the product page on TE.com>](#)

EU RoHS Directive 2011/65/EU	Compliant
EU ELV Directive 2000/53/EC	Compliant
China RoHS 2 Directive MIIT Order No 32, 2016	No Restricted Materials Above Threshold
EU REACH Regulation (EC) No. 1907/2006	Current ECHA Candidate List: JUNE 2023 (235) Candidate List Declared Against: JUNE 2023 (235) Does not contain REACH SVHC
Halogen Content	Not Low Halogen - contains Br or Cl > 900 ppm.
Solder Process Capability	Not reviewed for solder process capability

#### Product Compliance Disclaimer

This information is provided based on reasonable inquiry of our suppliers and represents our current actual knowledge based on the information they provided. This information is subject to change. The part numbers that TE has identified as EU RoHS compliant have a maximum concentration of 0.1% by weight in homogenous materials for lead, hexavalent chromium, mercury, PBB, PBDE, DBP, BBP, DEHP, DIBP, and 0.01% for cadmium, or qualify for an exemption to these limits as defined in the Annexes of Directive 2011/65/EU (RoHS2). Finished electrical and electronic equipment products will be CE marked as required by Directive 2011/65/EU. Components may not be CE marked. Additionally, the part numbers that TE has identified as EU ELV compliant have a maximum concentration of 0.1% by weight in homogenous materials for lead, hexavalent chromium, and mercury, and 0.01% for cadmium, or qualify for an exemption to these limits as defined in the Annexes of Directive 2000/53/EC (ELV). Regarding the REACH Regulation, the information TE provides on SVHC in articles for this part number is based on the latest European Chemicals Agency (ECHA) 'Guidance on requirements for substances in articles' posted at this URL: <https://echa.europa.eu/guidance-documents/guidance-on-reach>

### Compatible Parts



Also in the Series | GRACE INERTIA 3.3

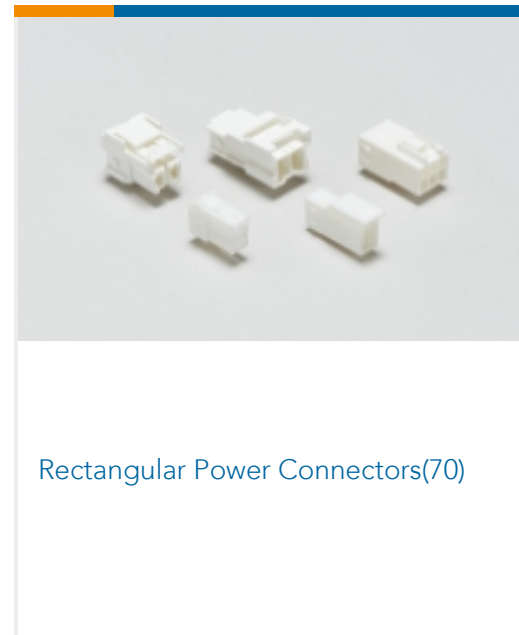
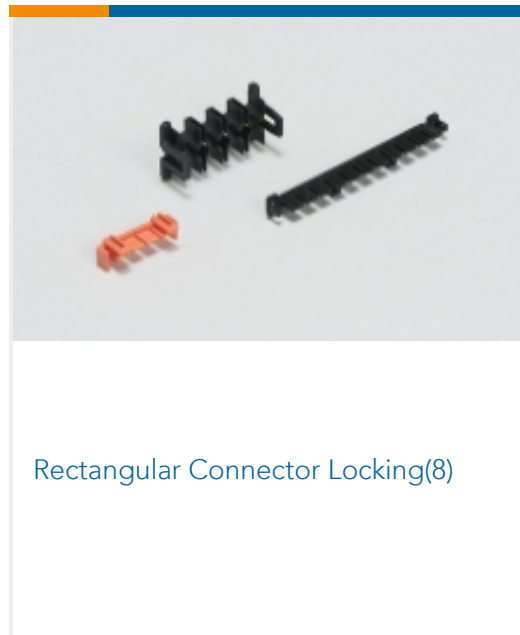
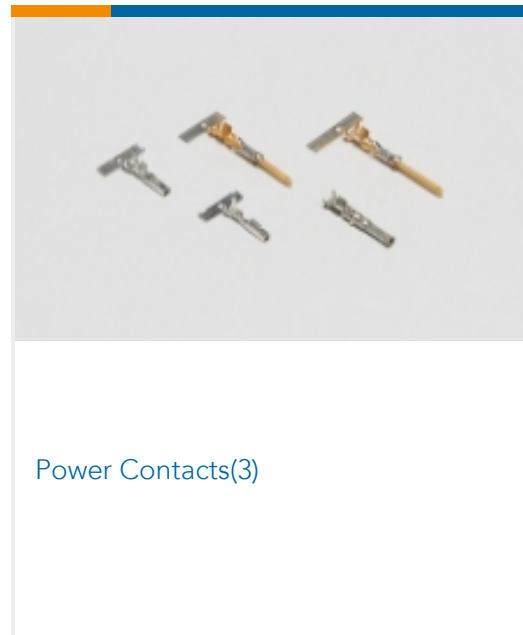

Customers Also Bought

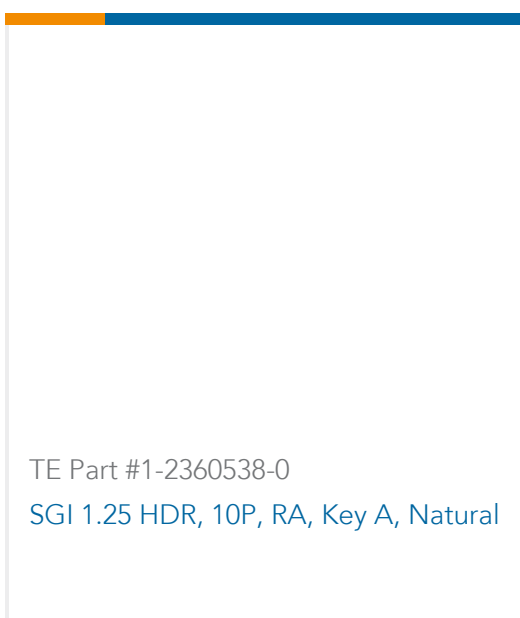
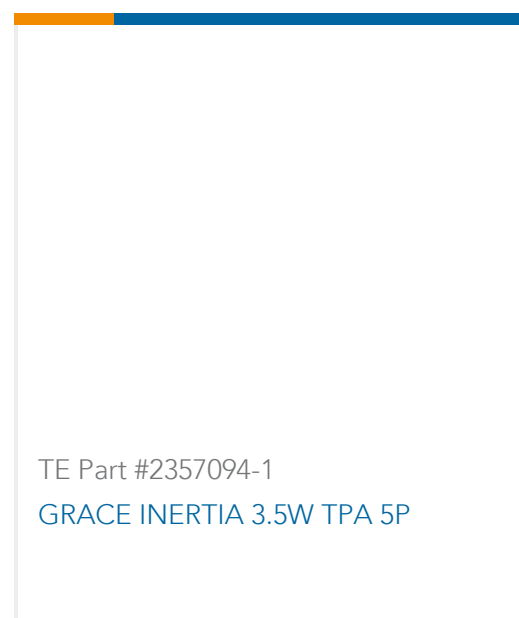
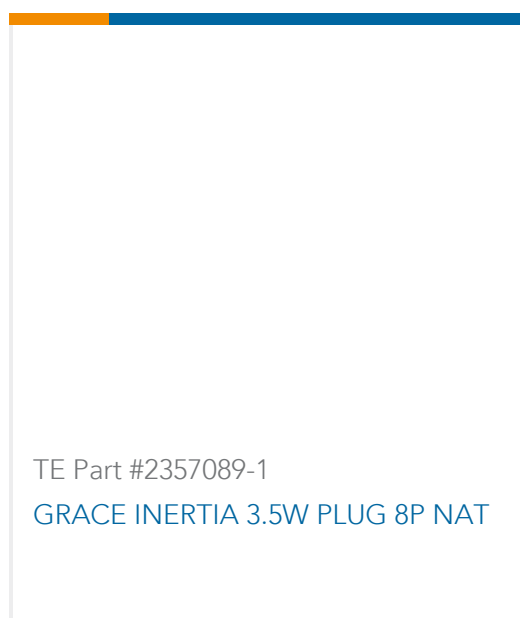
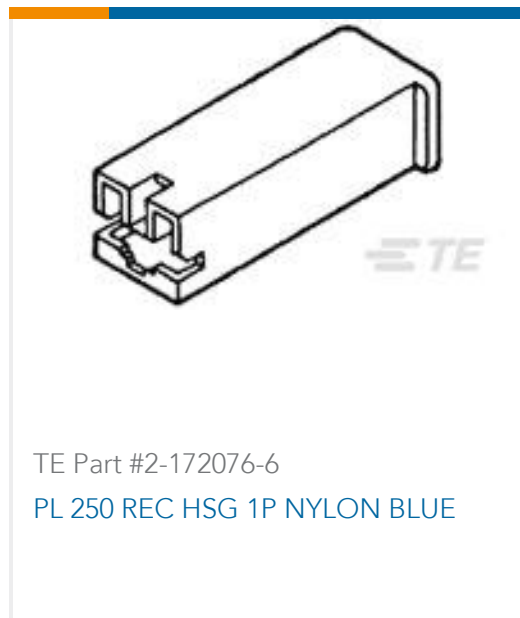



## Documents

### Product Drawings

[PLUG HOUSING 12POS,KEYING-D,NEW GIC3.3](#)

English

---

### CAD Files

[3D PDF](#)

3D

Customer View Model

[ENG\\_CVM\\_CVM\\_4-1971905-6\\_C.2d\\_dxf.zip](#)

English

Customer View Model

[ENG\\_CVM\\_CVM\\_4-1971905-6\\_C.3d\\_igs.zip](#)

English

Customer View Model

[ENG\\_CVM\\_CVM\\_4-1971905-6\\_C.3d\\_stp.zip](#)

English

By downloading the CAD file I accept and agree to the [Terms and Conditions](#) of use.

---

### Datasheets & Catalog Pages

[5-1773465-4-GI3.3Flyer](#)

English

[7-1773465-7-GI3.3-ChineseFlyer](#)

[GI3.3\\_QRG\\_CN](#)

---

### Product Specifications

[Application Specification](#)

English

---

### Product Environmental Compliance

[MD\\_4-1971905-6\\_12022013444\\_dmtec](#)

English

[MD\\_4-1971905-6\\_12022013444\\_dmtec](#)

English