

Features

- 0.86mm sq. large sensitive area
- Low dark current
- Low voltage operation
- Hermetic seal

Applications

- Near infrared sensors
- Laser diode and LED power monitors
- Near infrared spectroscopy
- Power meters

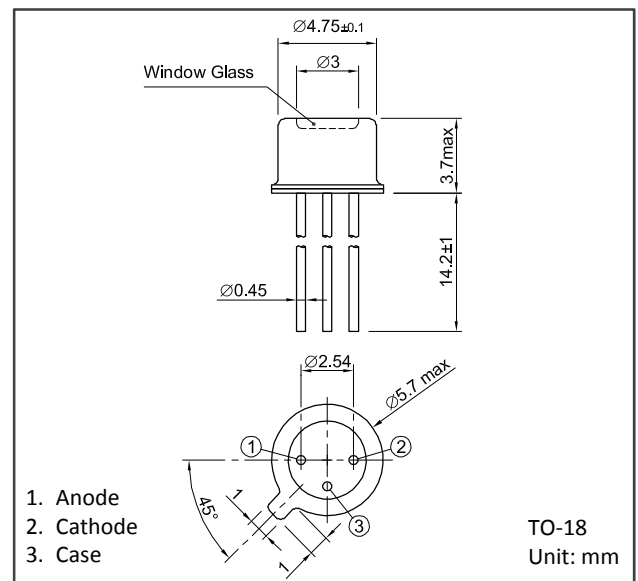

Absolute Maximum Ratings

Parameter	Symbol	Value	Unit	Note
Reverse voltage	V_R	20	V	
Maximum optical power input	$P_{i,max}$	50	mW	
Forward current	I_F	50	mA	
Operating temperature	T_{opr}	-40 to +85	°C	Avoid dew condensation
Storage temperature	T_{stg}	-40 to +85	°C	Avoid dew condensation

Electrical and Optical Characteristics (Ta=25°C unless otherwise noted)

Parameter	Symbol	Min.	Typ.	Max.	Unit	Test Condition
Active area	S	0.86 x 0.86			mm ²	
Bandwidth	BW	-	30	-	MHz	$P_i = -10\text{dBm}$, $V_R = 5\text{V}$, Small signal modulation
Responsivity	R	0.7	0.8	-	A/W	$\lambda = 1310\text{nm}$, $V_R = 5\text{V}$
		0.8	0.9	-		$\lambda = 1550\text{nm}$, $V_R = 5\text{V}$
Dark current	I_D	-	1	10	nA	$V_R = 5\text{V}$
Chip capacitance	C_{chip}	-	45	60	pF	$V_R = 5\text{V}$, $f = 1\text{MHz}$
Total capacitance	C_t	-	45	60	pF	$V_R = 5\text{V}$, $f = 1\text{MHz}$
Responsivity uniformity	ΔR	-	-	0.5	dB	$\lambda = 1530\text{-}1610\text{nm}$, $T_{op} = -10$ to $+85^\circ\text{C}$

Spectral Responsivity

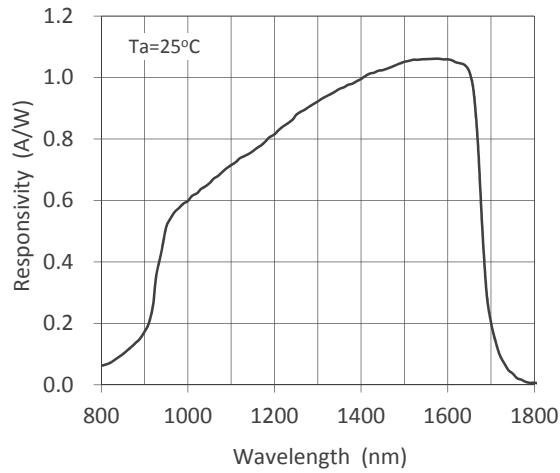

Uniformity of Spectral Responsivity

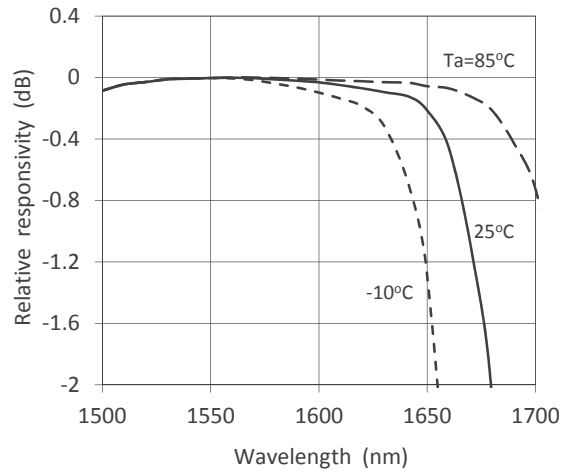

Frequency Response

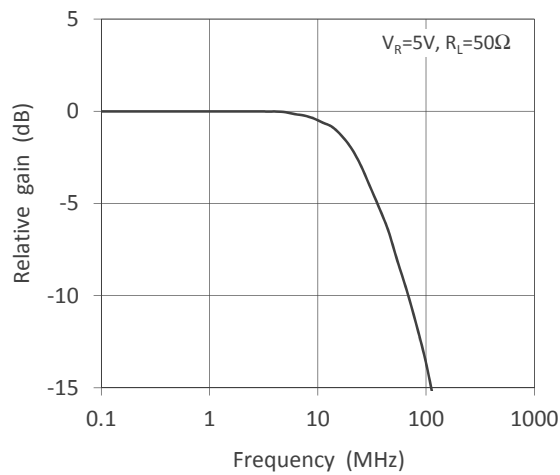

Capacitance - Reverse Voltage

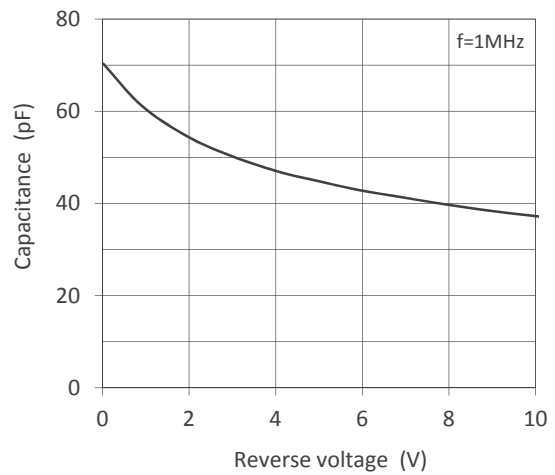

Dark Current - Ambient Temperature

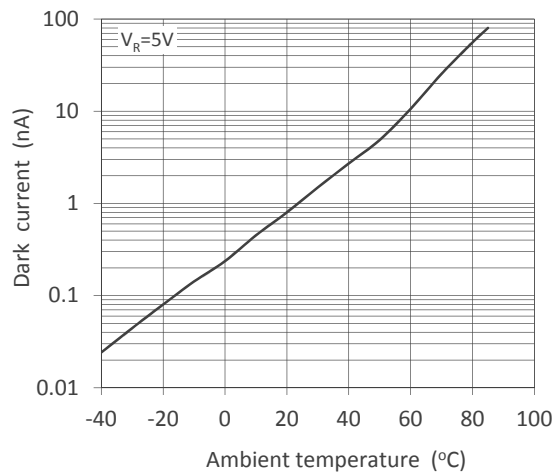

Dark Current - Reverse Voltage

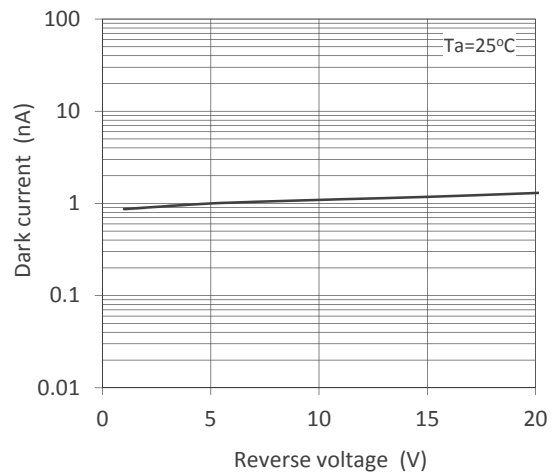

- Specifications , characteristics, data, materials, structures specified in this datasheet are subject to change without notice. Please refer to the latest specification before use of the products.
- Products listed in this datasheet comply with the RoHS Directive (EU2002/95/EC).

Opto-technologies for the Future



KYOSEMI CORPORATION

<http://www.kyosemi.co.jp/>

Headquarters : 949-2 Ebisucho Fushimi-ku, Kyoto 612-8201 Japan

TEL: +81-75-605-7311

Tokyo Sales Office: 24th Sky Bldg.2F, 1-34-3 Shinjuku Shinjuku-ku, Tokyo 160-0022 Japan

TEL: +81-3-5312-5360

Kansai Sales Office: 949-2 Ebisucho Fushimi-ku, Kyoto 612-8201 Japan

TEL: +81-75-605-7311

Kyosemi Opto America Corp: 4655 Old Ironsides Suite 230 Santa Clara, California 95054 USA

TEL: +1-408-492-9361

Eniwa Operation: 385-31 Toiso Eniwa-shi, Hokkaido 061-1405 Japan

TEL: +81-123-34-3111

Kamisunagawa Operation: 70-1 Kamisunagawa Kamisunagawa-cho Sorachi-gun, Hokkaido 073-0200 Japan

TEL: +81-125-62-3611